

Absolute encoders - SSI

Encoder kit

Magnetic single- or multiturn encoders 14 bit ST / 18 bit MT

EAM580-K - SSI - MAGRES



EAM580 Kit with cable

Technical data - electrical ratings

Voltage supply	4.5...30 VDC (SSI, SSI + TTL/ RS422) 5.5...30 VDC (SSI + HTL/ Push-pull)
Consumption typ.	60 mA (5 VDC, w/o load) 20 mA (24 VDC, w/o load)
Initializing time	≤170 ms after power on
Data currency	Typ. 2 μs (cyclic request)
Interfaces	SSI, SSI + incremental
Function	Multiturn, Singleturn
Operating mode	Linear feedback shift register (on request)
Steps per revolution	≤16384 / 14 bit
Number of revolutions	≤262144 / 18 bit
Absolute accuracy	±0.15 ° (+20 ±15 °C) ±0.25 ° (-40...+85 °C)
Sensing method	Magnetic
Code	Gray or binary
Code sequence	CW: ascending values with clockwise sense of rotation; looking at flange
Inputs	SSI clock: Linereceiver RS422 Zero setting input Counting direction
Output stages	SSI data: Linedriver RS422 Incremental: linedriver RS422 or push-pull (option)
Incremental output	1024, 2048, 4096 ppr (other on request)
Output signals	A+, A-, B+, B-
Output frequency	≤350 kHz
Interference immunity	DIN EN 61000-6-2
Emitted interference	DIN EN 61000-6-4
Diagnostic function	DATAVALID (on request)

Features

- Encoder kit single- or multiturn / SSI
- Precise magnetic sensing
- Angular accuracy up to ±0.15°
- Resolution max. 32 bit (14 bit ST, 18 bit MT)
- Additional incremental signals
- Clock frequency up to 2 MHz
- High protection up to IP 67
- High resistance to shock and vibrations

Optional

- Protection against corrosion C5-M

Technical data - mechanical design

Size (flange)	ø58 mm
Shaft type	ø6 mm (magnet bore) ø8 mm (magnet bore) ø12 mm (magnet bore)
Protection DIN EN 60529	IP 67
Operating speed	≤6000 rpm
Working distance	1.1 ±0.9 mm axial / ≤0.3 mm eccentricity
Materials	Housing: steel zinc-coated Flange: aluminium
Operating temperature	-40...+85 °C (see general information)
Relative humidity	95 %
Resistance	DIN EN 60068-2-6 Vibration 30 g, 10-2000 Hz DIN EN 60068-2-27 Shock 500 g, 1 ms
Weight approx.	250 g
Connection	Flange connector M12, 8-pin Flange connector M12, 12-pin Cable 2 m

Absolute encoders - SSI

Encoder kit

Magnetic single- or multiturn encoders 14 bit ST / 18 bit MT

EAM580-K - SSI - MAGRES

Part number

EAM580-K Y . 7A

Resolution incremental signals

- 0 Without incremental signals
- H 4096 pulses, TTL (RS422)
- 8 2048 pulses, TTL (RS422)
- 5 1024 pulses, TTL (RS422)

Resolution multiturn

- 00 No option
- 12 12 bit
- 13 13 bit
- 16 16 bit
- 18 18 bit

Resolution singleturn

- 12 12 bit
- 13 13 bit
- 14 14 bit

Voltage supply / signals

- 4B 4.5...30 VDC / SSI binary
- 4G 4.5...30 VDC / SSI gray

Connection

- B Flange connector M12, 8-pin, radial, male contact, CCW
- K Flange connector M12, 12-pin, radial, male contact, CCW*
- L Cable 2 m, radial

Protection

- 7 IP 67

Magnet holder / bore diameter

- 6 ø6 mm
- 8 ø8 mm
- C ø12 mm

Flange

- Y Synchro flange, flute ø53 mm, M3/M4

* Only available for SSI with incremental signals

Absolute encoders - SSI

Encoder kit

Magnetic single- or multturn encoders 14 bit ST / 18 bit MT

EAM580-K - SSI - MAGRES

Accessories

Connectors and cables

10146775	Female connector M12, 8-pin, straight, without cable
11170528	Female connector M12, 8-pin, straight, shielded, 5 m cable (ESG 34FH0500GVS)
11177375	Female connector M12, 8-pin, straight, shielded, 10 m cable (ESG 34FH1000GVS)
11091511	Female connector M12, 8-pin, straight, shielded, 20 m cable
10116717	Female connector M23, 12-pin, straight, without cable
11078614	Female connector M12, 12-pin, straight, without cable
11048452	Female connector M12, 12-pin, straight, shielded, 2 m cable (ESG 34JP0200G)
11043780	Female connector M12, 12-pin, straight, shielded, 5 m cable (ESG 34JP0500G)
11048455	Female connector M12, 12-pin, straight, shielded, 10 m cable (ESG 34JP1000G)

Mounting accessories

10106004	Clamp set \varnothing 10 mm
----------	-------------------------------

General information

Self-heating correlated to installation and ambient conditions as well as to electronics and supply voltage must be considered for precise thermal dimensioning. Operating the encoder close to the maximum limits requires measuring the real prevailing temperature at the encoder flange.

Terminal assignment

Cable / Flange connector M12, 8-pin for connection reference -L and -B

Pin	Core color	Signals	Description
1	white	0 V	Supply voltage
2	brown	+Vs	Supply voltage
3	green	Clock+	Clock signal
4	yellow	Clock-	Clock signal
5	grey	Data+	Data signal
6	pink	Data-	Data signal
7	blue	SET	Zero setting input
8	red	DIR	Counting direction input*

Screen connected to housing

Cable data: 4 x 2 x 0.14 mm², twisted in pairs

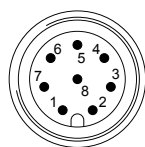

Male, A-coded

Cable / Flange connector M12, 12-pin for connection reference -L and -K

Pin	Core color	Signals	Description
1	brown	+Vs	Supply voltage
2	blue	SET	Zero setting input
3	white	0 V	Supply voltage
4	green	Clock+	Clock signal
5	pink	Data-	Data signal
6	yellow	Clock-	Clock signal
7	black	A+	Incremental signal
8	grey	Data+	Data signal
9	red	DIR	Counting direction input*
10	violet	A-	Incremental signal
11	grey/pink	B+	Incremental signal
12	red/blue	B-	Incremental signal

Screen connected to housing

Cable data: 6 x 2 x 0.14 mm², twisted in pairs

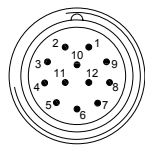

Male, A-coded

* Not applicable by option: DATAVALID

Absolute encoders - SSI

Encoder kit

Magnetic single- or multturn encoders 14 bit ST / 18 bit MT

EAM580-K - SSI - MAGRES

Terminal significance

SET	Zero setting. Input for zero setting at any position. The zero setting operation is triggered by a high pulse and has to be in line with the selected direction of rotation (DIR). Impulse duration >100 ms. Connect to 0 V after zero setting for maximum interference immunity.
DIR	Counting direction input. CW HIGH - CCW LOW The input is standard on high. For maximum interference immunity connect to +Vs respectively 0 V depending on counting direction. (Version with DATAVALID does not include the counting direction input).

Output signals

Incremental signals: clockwise rotating direction when looking at flange.

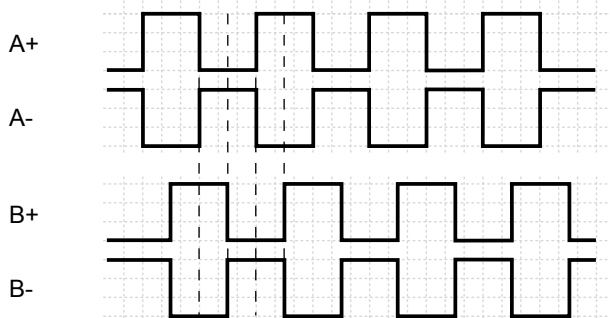

Working distance

The ideal working distance of the magnet related to the encoder is at an eccentricity of 0 mm and an axial distance of 1.1 mm. Deviation affects the accuracy as shown in following diagram.

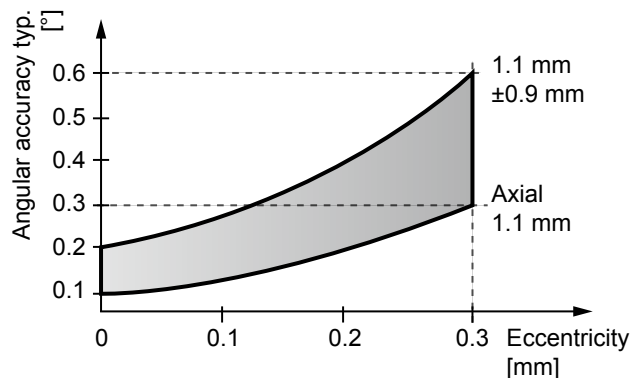

Data transfer

Output signal

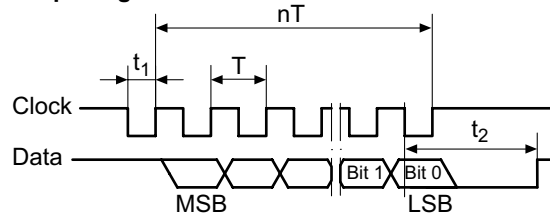

$T = 0.5 \dots 10 \mu\text{s}$	$t_1 = 0.25 \dots 5 \mu\text{s}$
$t_2 = 20 \pm 2 \mu\text{s}$	$f \text{ max.} = 2 \text{ MHz}$

Data acquisition time t_a

Following timing of the SSI Masters is the requirement for a data refresh rate of typ. 2 μs . If this is not fulfilled the data refresh rate is <50 μs .

$t_a < 5000 \mu\text{s}$
 $t_a \text{ jitter} < \pm 2 \mu\text{s}$

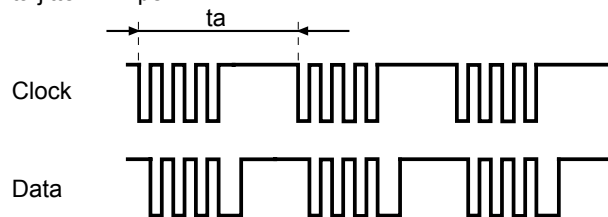

Trigger level

Control inputs	Input circuit
Maximal	0...+Vs
Input level Low	<1 V
Input level High	>2.1 V

RS422

Output level High	>2.3 V
Output level Low	<0.5 V
Load	<20 mA

Push-pull

Output level High	$\geq +V_S - 2.2 \text{ V}$
Output level Low	<0.7 V
Load	<20 mA

Applies to standard cable lengths up to 2 m, for longer cables the voltage drop must be taken into account.

Absolute encoders - SSI

Encoder kit

Magnetic single- or multiturn encoders 14 bit ST / 18 bit MT

EAM580-K - SSI - MAGRES

Dimensions

EAM580 Kit, cable

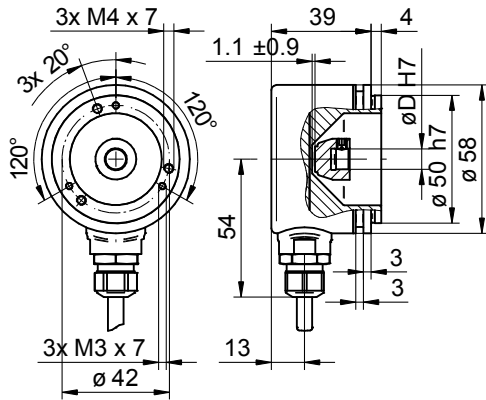

EAM580 Kit, M12

