

Distance sensors

OM70-11200061

dimension drawing

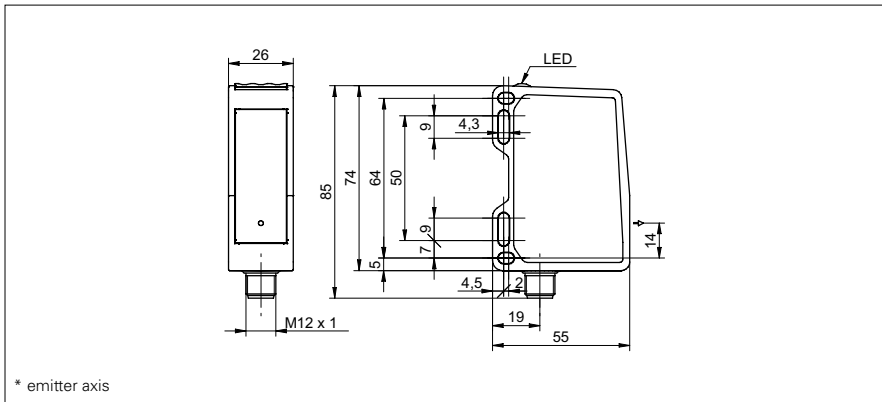

* emitter axis

general data

type	distance measuring
version	OM70 laser point
measuring distance Sd	40 ... 140 mm
measuring range Mr	100 mm
focal range	50 ... 90 mm
sweet spot	70 mm
adjustment	Touch Display, RS485
power on indication	LED green
output indicator	LED yellow / LED red
resolution	1,2 ... 2,5 µm 1) 2) 3)
repeat accuracy	0,3 ... 0,7 µm 1) 2) 3)
linearity error	± 0,07 % Mr 1) 2)
light source	pulsed red laser diode
wave length	660 nm
laser class	1
beam type	point
temperature drift	0,015 % Sde/K 1) 2)
hysteresis digital output	adjustable

electrical data

response time / release time	0,8 ms 2)
measuring frequency	2500 Hz 2)
voltage supply range +Vs	15 ... 28 VDC
current consumption max. (no load)	75 mA
output circuit	analog and RS 485
baud rate	115200, adjustable
output signal	4 ... 20 mA / 0 ... 10 VDC
output current	< 100 mA
switching output	push-pull
short circuit protection	yes
reverse polarity protection	yes, Vs to GND

photo



connection diagram

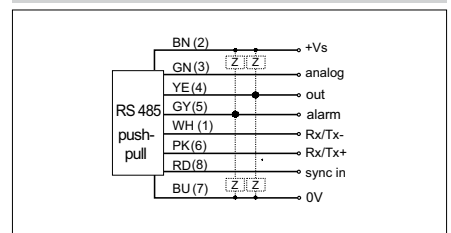

laser warning

CLASS 1 LASER PRODUCT

IEC 60825-1/2014
Complies with 21 CFR 1040.10 and 1040.11
except for deviations pursuant to laser
notice No. 50, dated June 24, 2007

Distance sensors

OM70-11200061

mechanical data

width / diameter	26 mm
height / length	74 mm
depth	55 mm
type	rectangular, front view
housing material	aluminum
front (optics)	glass
connection types	connector M12 8 pin
weight	130 g

ambient conditions

ambient light immunity	< 38 kLux
operating temperature	-10 ... +50 °C
protection class	IP 67
vibration (sinusoidal)	IEC 60068-2-6:2008 ± 0.75 mm p-p at f = 10 - 58 Hz, 10 cycles per axis 10 g at f = 58 - 2000 Hz, 10 cycles per axis
shock (semi-sinusoidal)	IEC 60068-2-27:2009 50 g / 11 ms resp. 100 g / 6 ms, 10 jolts per axis and direction 100 g / 2 ms, 5000 jolts per axis and direction



- 1) Measurement with Baumer standardized measuring equipment and targets depending on measuring distance Sd
- 2) Measurement on 90% remission (white)
- 3) Measurement with filtering

beam characteristic (typically)

