

Documentation

BX5100

Bus Terminal Controller for CANopen

Version: 2.0.0
Date: 2017-04-18

BECKHOFF

Table of contents

1 Foreword	7
1.1 Notes on the documentation.....	7
1.2 Safety instructions	8
1.3 Documentation issue status	9
2 Product overview	11
2.1 Bus Terminal Controllers of the BX series.....	11
2.2 The principle of the Bus Terminal.....	12
2.3 The Beckhoff Bus Terminal system	12
2.4 Technical data	14
2.4.1 Technical Data CANopen SSB Interface	14
2.4.2 Technical data - BX	15
2.4.3 Technical Data - PLC.....	17
3 Mounting and wiring	18
3.1 Mounting.....	18
3.1.1 Dimensions	18
3.1.2 Installation on mounting rails	19
3.2 Wiring.....	20
3.2.1 Potential groups, insulation testing and PE	20
3.2.2 Power supply	22
3.2.3 Programming cable for COM1	24
3.2.4 SSB and COM interface	25
3.2.5 CANopen cabling.....	26
4 Parameterization and Commissioning	34
4.1 Start-up behavior of the Bus Terminal Controller	34
4.2 Configuration	34
4.2.1 Overview	34
4.2.2 Creating a TwinCAT configuration.....	36
4.2.3 Downloading a TwinCAT configuration.....	37
4.2.4 Uploading a TwinCAT configuration	39
4.2.5 Resources in the Bus Terminal Controller	40
4.2.6 ADS connection via serial interface	43
4.2.7 CANopen slave interface	44
4.2.8 K-bus	48
4.2.9 PLC.....	50
4.2.10 SSB.....	53
4.2.11 Real-Time Clock (RTC)	74
4.2.12 COM port	75
4.2.13 Menu.....	76
4.2.14 Configuration software KS2000	80
5 Programming	81
5.1 PLC features of the BX controllers	81
5.2 TwinCAT PLC.....	81
5.3 TwinCAT PLC - Error codes	82

5.4	Persistent data	84
5.5	Remanent data	85
5.6	Allocated flags	86
5.7	Local process image in delivery state	87
5.8	Mapping the Bus Terminals	88
5.9	Creating a boot project	89
5.10	Local process image in the TwinCAT configuration	90
5.11	Communication between TwinCAT and BX/BCxx50	91
5.12	Up- and downloading of programs	92
5.13	Libraries	95
5.13.1	Libraries overview	95
5.13.2	TcBaseBX	98
5.13.3	TcSystemBX	109
5.13.4	TcComPortBX	112
5.13.5	TcTwinSAFE	122
5.14	Program transfer	129
5.14.1	Program transfer via the serial interface	129
5.14.2	Programming via CANopen	131
6	CANopen Communication	133
6.1	CANopen Introduction	133
6.2	Protocol Description	134
6.2.1	Network Management	134
6.2.2	Process Data Objects (PDO)	139
6.2.3	PDO Parameterization	146
6.2.4	Service Data Objects (SDO)	148
6.2.5	Identifier Allocation	151
6.3	Object directory	153
6.3.1	Object directory structure	153
6.3.2	Object list	154
6.3.3	Objects and Data	156
6.3.4	Objects and data of BX5100/BC5150	179
6.4	ADS-Communication	180
6.4.1	ADS services	180
7	Error handling and diagnosis	181
7.1	Diagnostics	181
7.2	Diagnostic LEDs	182
7.3	Diagnostics display	186
8	Appendix	187
8.1	Quick Start for Experienced Users	187
8.2	CAN Identifier List	190
8.3	Firmware Update	205
8.4	CFC-Client*	207
8.5	Sample programs - overview	210
8.6	General operating conditions	210
8.7	Approvals	211

8.8	Test standards for device testing.....	212
8.9	Bibliography.....	212
8.10	List of Abbreviations.....	213
8.11	Support and Service.....	215

1 Foreword

1.1 Notes on the documentation

Intended audience

This description is only intended for the use of trained specialists in control and automation engineering who are familiar with the applicable national standards.

It is essential that the documentation and the following notes and explanations are followed when installing and commissioning these components.

It is the duty of the technical personnel to use the documentation published at the respective time of each installation and commissioning.

The responsible staff must ensure that the application or use of the products described satisfy all the requirements for safety, including all the relevant laws, regulations, guidelines and standards.

Disclaimer

The documentation has been prepared with care. The products described are, however, constantly under development.

We reserve the right to revise and change the documentation at any time and without prior announcement.

No claims for the modification of products that have already been supplied may be made on the basis of the data, diagrams and descriptions in this documentation.

Trademarks

Beckhoff®, TwinCAT®, EtherCAT®, EtherCAT P®, Safety over EtherCAT®, TwinSAFE®, XFC® and XTS® are registered trademarks of and licensed by Beckhoff Automation GmbH.

Other designations used in this publication may be trademarks whose use by third parties for their own purposes could violate the rights of the owners.

Patent Pending

The EtherCAT Technology is covered, including but not limited to the following patent applications and patents: EP1590927, EP1789857, DE102004044764, DE102007017835 with corresponding applications or registrations in various other countries.

The TwinCAT Technology is covered, including but not limited to the following patent applications and patents: EP0851348, US6167425 with corresponding applications or registrations in various other countries.

The logo for EtherCAT, featuring the word "EtherCAT" in a bold, black, sans-serif font. A red arrow points from the top of the "A" towards the right, ending above the "T". A registered trademark symbol (®) is located to the right of the "T".

EtherCAT® is registered trademark and patented technology, licensed by Beckhoff Automation GmbH, Germany.

Copyright

© Beckhoff Automation GmbH & Co. KG, Germany.

The reproduction, distribution and utilization of this document as well as the communication of its contents to others without express authorization are prohibited.

Offenders will be held liable for the payment of damages. All rights reserved in the event of the grant of a patent, utility model or design.

1.2 Safety instructions

Safety regulations

Please note the following safety instructions and explanations!
Product-specific safety instructions can be found on following pages or in the areas mounting, wiring, commissioning etc.

Exclusion of liability

All the components are supplied in particular hardware and software configurations appropriate for the application. Modifications to hardware or software configurations other than those described in the documentation are not permitted, and nullify the liability of Beckhoff Automation GmbH & Co. KG.

Personnel qualification

This description is only intended for trained specialists in control, automation and drive engineering who are familiar with the applicable national standards.

Description of instructions

In this documentation the following instructions are used.
These instructions must be read carefully and followed without fail!

DANGER

Serious risk of injury!

Failure to follow this safety instruction directly endangers the life and health of persons.

WARNING

Risk of injury!

Failure to follow this safety instruction endangers the life and health of persons.

CAUTION

Personal injuries!

Failure to follow this safety instruction can lead to injuries to persons.

NOTE

Damage to environment/equipment or data loss

Failure to follow this instruction can lead to environmental damage, equipment damage or data loss.



Tip or pointer

This symbol indicates information that contributes to better understanding.

1.3 Documentation issue status

Version	Modifications
2.0.0	<ul style="list-style-type: none">• Migration• ADS services updated
1.2.0	<ul style="list-style-type: none">• Update to firmware version 1.20
1.1.7	<ul style="list-style-type: none">• Update to firmware version 1.17
1.1.6	<ul style="list-style-type: none">• Update to firmware version 1.16
1.1.4	<ul style="list-style-type: none">• Update to firmware version 1.14
1.1.0	<ul style="list-style-type: none">• Notes to meet the UL requirements added.
1.0.9	<ul style="list-style-type: none">• Update to firmware version 1.09
1.0.8	<ul style="list-style-type: none">• Update to firmware version 1.08
1.0.7	<ul style="list-style-type: none">• Update to firmware version 1.07
1.0.6	<ul style="list-style-type: none">• Update to firmware version 1.06
1.0.5	<ul style="list-style-type: none">• Update to firmware version 1.05
1.0.4	<ul style="list-style-type: none">• Update to firmware version 1.04
1.0.1	<ul style="list-style-type: none">• Update to firmware version 1.01
1.0.0	<ul style="list-style-type: none">• Update to firmware version 1.00

BX5100 firmware

The BX controller displays its firmware version for about 3 seconds when it is switched on. For updating your firmware you need a serial cable, the KS2000 configuration software, or the firmware update program.

Firmware	Description
1.27	<ul style="list-style-type: none"> From this version the BX can also be used without K-bus terminals, if none are configured in the System Manager; no error will be generated
1.20	<ul style="list-style-type: none"> support of TwinSAFE terminals; only one logic terminal is permitted at the K-bus, with a maximum of seven connections Switching of the COM 2 interface between RS232 and RS485 modified <p>ATTENTION Firmware 1.20 does not run on older hardware versions (lower than 3.5). Please take the hardware version of your BX Controller from its sticker</p>
1.17	<ul style="list-style-type: none"> New: Support of persistent data Forcing and reading of the TwinCAT configuration corrected CFC tool is supported as in firmware 1.14 and lower
1.16	<ul style="list-style-type: none"> Online change problem rectified for large projects New: Display backlight can be switched off New: Boot project CRC display can be enabled during booting REAL_TO_STRING: Real variables, e.g. 9.0, are now output as string in this form, i.e. '9.0' (previously '9.') TC-Config: 4-way and 8-way analog terminals fixed
1.14	<ul style="list-style-type: none"> K-bus updated CAN slave interface updated SSB reset of the SSB implemented Generic function implemented Non-implemented features are disabled with the System Manager, Build 1303. Writing of outputs is possible with TwinCAT Build 1302 Optimization of the terminal verification in a TwinCAT configuration The TC-Config supports KL1212 The TC-Config supports KM modules
1.14	<ul style="list-style-type: none"> K-bus updated CAN slave interface updated SSB reset of the SSB implemented Generic function implemented Non-implemented features are disabled with the System Manager, Build 1303. Writing of outputs is possible with TwinCAT Build 1302 Optimization of the terminal verification in a TwinCAT configuration The TC-Config supports KL1212 The TC-Config supports KM modules
1.09 / 0.99i	<ul style="list-style-type: none"> Code optimization, resulting in a performance enhancement of around 30% Optimization of TcComPortBX.lbx - Fb_BX_BK8x00_slave improved diagnostics NEW: CFC client support implemented (Controller Flash Copy client)
1.08 / 0.99h	<ul style="list-style-type: none"> SSB optimization
1.07 / 0.99g	<ul style="list-style-type: none"> Serial ADS optimization Online change optimization
1.06 / 0.99f	<ul style="list-style-type: none"> COM 1 serial ADS optimization
1.05 / 0.99e	<ul style="list-style-type: none"> If a PLC reset is triggered too soon after an online change, an error message is issued saying that the service is not yet ready. Optimization at the SSB Disabling of the red PLC cycle monitoring LED
1.04 / 0.99d	<ul style="list-style-type: none"> Loading and storing of recipes, new function in TcSystemBX fb_ReadWriteFile Optimization: TcComPortBX, FB_BX_COM_64ex
1.01 / 0.99a	<ul style="list-style-type: none"> From PDO 5, up to PDO 32 can be activated in the default configuration If the boot project is created immediately after an online change, an error message is issued saying that the service is not yet ready.
1.00 / 0.99	<ul style="list-style-type: none"> Fieldbus diagnostics implemented in TwinCAT configuration

*) The versions 1.xx only support the new (blue) display! The versions 0.99x only support the old (green) display!

2 Product overview

2.1 Bus Terminal Controllers of the BX series

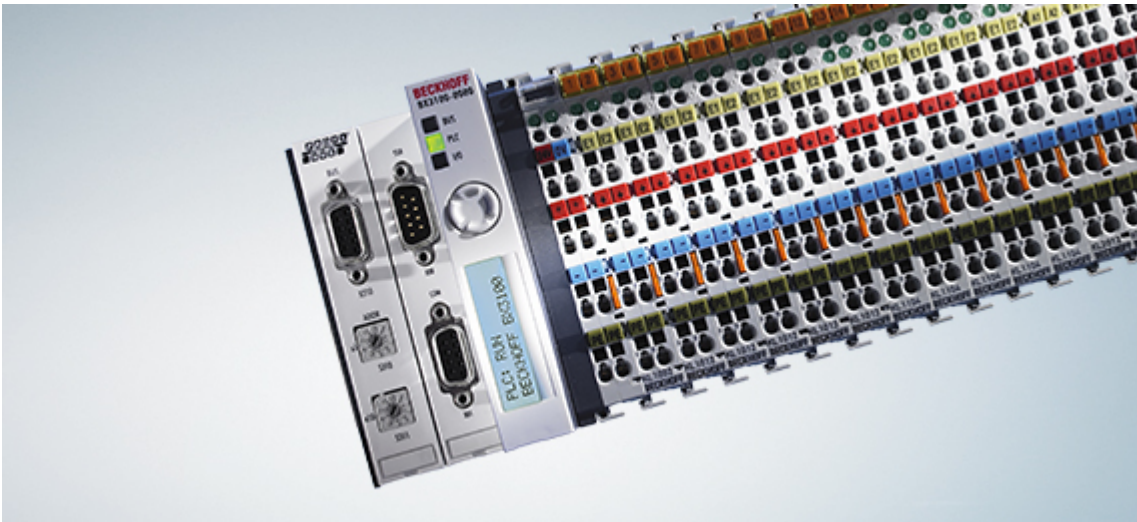

Fig. 1: Bus Terminal Controllers of the BX series

The Bus Terminal Controllers of the BX series (BX controllers) offer a high degree of flexibility. In terms of the equipment and performance range, the BX series is positioned between the BC series Bus Terminal controller and the CX1000 Embedded PC. The concept of a stand-alone controller in combination with a link to a higher-level fieldbus system is based on the BC series. The housing design originates from the CX1000. The main features distinguishing the BC and BX series are the larger memory and the expanded interfaces of the BX series.

The BX controllers consist of a programmable IEC 61131-3 controller, a connection to the higher-level fieldbus system and the K-bus interface for connecting the Beckhoff Bus Terminals. In addition, the BX controllers have two serial interfaces: one for programming, the other for free utilization. The device itself includes an illuminated LC display (2 rows with 16 characters each) with joystick switch and a real-time clock. Further peripheral devices, e.g. displays, can be connected via the integrated Beckhoff Smart System Bus (SSB).

The Bus Terminals are connected on the right side of the BX controller, as usual. The comprehensive range of different I/Os enables any input signal to be read and any output signal that may be required to be generated. The BX controllers can be used for a wide range of automation tasks, from garage door control to autonomous temperature control at injection molding machines. The BX controllers are also eminently suitable for a modular machine concept. Within a network, the BX controllers can exchange data with other machine components via the fieldbus interfaces. The real-time clock also enables decentralized applications, for which the day of the week or the time play an important role.

The areas of application of this series are similar to that of the BC series, but due to the larger memory the BX can execute significantly more complex and larger programs and can manage more data locally (e.g. history and trend data recording), which are then successively fetched over the fieldbus.

● Bus Terminal and end terminal required

i To operate a BX controller, at least one Bus Terminal with process image and the end terminal must be connected to its K-bus.

Fieldbus interface

The variants of the BX series Bus Terminal Controllers differ in terms of their fieldbus interfaces. Additionally, two serial interfaces are integrated for programming and for the connection of further serial devices. Five different versions cover the main fieldbus systems:

- BX3100: PROFIBUS DP

- [BX5100](#): CANopen
- [BX5200](#): DeviceNet
- [BX8000](#): RS232 or RS485 (without fieldbus interface)
- [BX9000](#): Ethernet ModbusTCP/ADS-TCP/UDP

Programming

The BX controllers are programmed based on the effective IEC 61131-3 standard. As with all other Beckhoff controllers, the TwinCAT automation software is the basis for parameterization and programming. Users therefore have the familiar TwinCAT tools available, e.g. PLC programming interface, System Manager and TwinCAT Scope. Data is exchanged optionally via the serial port (COM1) or via the fieldbus through Beckhoff PC FCxxx fieldbus cards.

Configuration

The configuration is also carried out using TwinCAT. The fieldbus interface, the SSB bus and the real-time clock can be configured and parameterized via the System Manager. The System Manager can read all connected devices and Bus Terminals. After the parameterization, the configuration is saved on the BX via the serial interface. The configuration thus created can be accessed again later.

2.2 The principle of the Bus Terminal

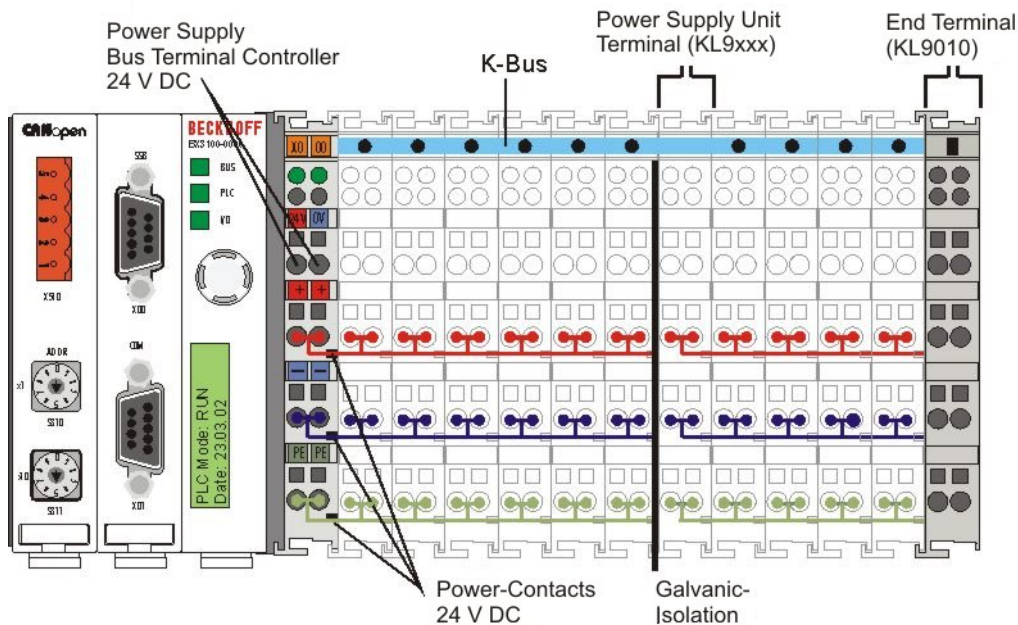

2.3 The Beckhoff Bus Terminal system

Up to 256 Bus Terminals, with 1 to 16 I/O channels per signal form

The Bus Terminal system is the universal interface between a fieldbus system and the sensor / actuator level. A unit consists of a Bus Coupler as the head station, and up to 64 electronic series terminals, the last one being an end terminal. Up to 255 Bus Terminals can be connected via the K-bus extension. For each

technical signal form, terminals are available with one, two, four or eight I/O channels, which can be mixed as required. All the terminal types have the same mechanical construction, so that difficulties of planning and design are minimized. The height and depth match the dimensions of compact terminal boxes.

Decentralised wiring of each I/O level

Fieldbus technology allows more compact forms of controller to be used. The I/O level does not have to be brought to the controller. The sensors and actuators can be wired decentrally, using minimum cable lengths. The controller can be installed at any location within the plant.

Industrial PCs as controllers

The use of an Industrial PC as the controller means that the operating and observing element can be implemented in the controller's hardware. The controller can therefore be located at an operating panel, in a control room, or at some similar place. The Bus Terminals form the decentralised input/output level of the controller in the control cabinet and the subsidiary terminal boxes. The power sector of the plant is also controlled over the bus system in addition to the sensor/actuator level. The Bus Terminal replaces the conventional series terminal as the wiring level in the control cabinet. The control cabinet can have smaller dimensions.

Bus Couplers for all usual bus systems

The Beckhoff Bus Terminal system unites the advantages of a bus system with the possibilities of the compact series terminal. Bus Terminals can be driven within all the usual bus systems, thus reducing the controller parts count. The Bus Terminals then behave like conventional connections for that bus system. All the performance features of the particular bus system are supported.

Mounting on standardized mounting rails

The installation is standardized thanks to the simple and space-saving mounting on a standardized mounting rail (EN 60715, 35 mm) and the direct wiring of actuators and sensors, without cross connections between the terminals. The consistent labelling scheme also contributes.

The small physical size and the great flexibility of the Bus Terminal system allow it to be used wherever a series terminal is also used. Every type of connection, such as analog, digital, serial or the direct connection of sensors can be implemented.

Modularity

The modular assembly of the terminal strip with Bus Terminals of various functions limits the number of unused channels to a maximum of one per function. The presence of two channels in one terminal is the optimum compromise of unused channels and the cost of each channel. The possibility of electrical isolation through potential feed terminals also helps to keep the number of unused channels low.

Display of the channel state

The integrated LEDs show the state of the channel at a location close to the sensors and actuators.

K-bus

The K-bus is the data path within a terminal strip. The K-bus is led through from the Bus Coupler through all the terminals via six contacts on the terminals' side walls. The end terminal terminates the K-bus. The user does not have to learn anything about the function of the K-bus or about the internal workings of the terminals and the Bus Coupler. Many software tools that can be supplied make project planning, configuration and operation easy.

Potential feed terminals for isolated groups

The operating voltage is passed on to following terminals via three power contacts. You can divide the terminal strip into arbitrary isolated groups by means of potential feed terminals. The potential feed terminals play no part in the control of the terminals, and can be inserted at any locations within the terminal strip.

Up to 64 Bus Terminals can be used in a terminal block, with optional K-bus extension for up to 256 Bus Terminals. This count does include potential feed terminals, but not the end terminal.

Bus Couplers for various fieldbus systems

Various Bus Couplers can be used to couple the electronic terminal strip quickly and easily to different fieldbus systems. It is also possible to convert to another fieldbus system at a later time. The Bus Coupler performs all the monitoring and control tasks that are necessary for operation of the connected Bus Terminals. The operation and configuration of the Bus Terminals is carried out exclusively by the Bus Coupler. Nevertheless, the parameters that have been set are stored in each Bus Terminal, and are retained in the event of voltage drop-out. Fieldbus, K-bus and I/O level are electrically isolated.

If the exchange of data over the fieldbus is prone to errors or fails for a period of time, register contents (such as counter states) are retained, digital outputs are cleared, and analog outputs take a value that can be configured for each output when commissioning. The default setting for analog outputs is 0 V or 0 mA. Digital outputs return in the inactive state. The timeout periods for the Bus Couplers correspond to the usual settings for the fieldbus system. When converting to a different bus system it is necessary to bear in mind the need to change the timeout periods if the bus cycle time is longer.

The interfaces

A Bus Coupler has six different methods of connection. These interfaces are designed as plug connectors and as spring-loaded terminals.

2.4 Technical data

2.4.1 Technical Data CANopen SSB Interface

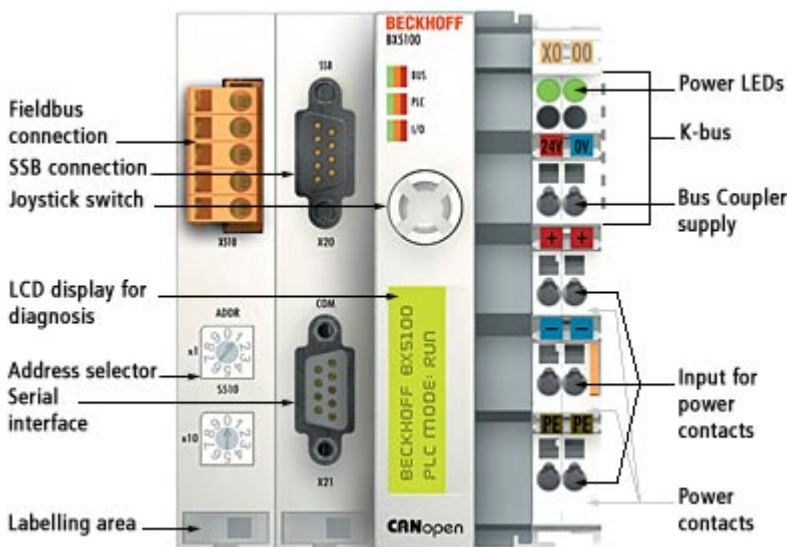

Fig. 2: BX5100

System data	CANopen (BX5100)							
Number of nodes	63, with repeater 99							
Number of I/O points	depending on controller							
Data transfer medium	shielded, twisted copper cable, 2 x signal, 1 x CAN ground (recommended)							
Cable length	5000 m	2500 m	1000 m	500 m	250 m	100 m	50 m	25 m
Data transfer rate	10 kBaud	20 kBaud	50 kBaud	125 kBaud	250 kBaud	500 kBaud	800 kBaud	1 MBaud
I/O communication types	event driven, cyclic, synchronous, polling							
Number of PDOs	32 send process data objects and 32 receive process data objects							
Baud rate	Automatic baud rate detection (for possible baud rates see data transfer rate)							



SSB	Data
Max. number of slaves	8
Max. number of PDOs	32 RxPDOs / 32 TxPDOs
Baud rate	10 k - 1 MBaud
Permitted slave addresses	1 to 64

2.4.2 Technical data - BX

Technical data	BX3100	BX5100	BX5200	BX8000	BX9000
Processor	16 bit micro-controller				
Diagnostic LEDs	2 x power supply, 2 x K-Bus				
Display	FSTN 2 x 16 lines display for diagnosis or own texts, illuminated				
Switch	Joystick switch for parameterization and diagnosis				
Clock	battery-powered internal clock for time and date				
Configuration and programming software	TwinCAT PLC				

Fieldbus interface	BX3100	BX5100	BX5200	BX8000	BX9000
Fieldbus	PROFIBUS DP	CANopen	DeviceNet	-	Ethernet

Interfaces	BX3100	BX5100	BX5200	BX8000	BX9000
Serial interface	COM1 (RS232 for configuration and programming, automatic baud rate detection 9600/19200/38400/57600 baud) COM2 (RS232 or RS485) for connecting serial devices				
SSB	CANopen-based sub-bus interface				
Terminal Bus (K-Bus)	64 (255 with K-bus extension)				

Technical data	BX3100	BX5100	BX5200	BX8000	BX9000
Digital peripheral signals	2040 inputs/outputs				
Analog peripheral signals	1024 inputs/outputs				
Configuration possibility	via TwinCAT or the controller				
max. number of bytes, fieldbus	depending on fieldbus				
max. number of bytes, PLC	2048 bytes of input data, 2048 bytes of output data				
Fieldbus connection	D-sub, 9-pin	Open Style Connector, 5 pin	-	RJ45	
Power supply (Us)	24 V _{DC} (-15% /+20%) Use a 4 A fuse or an <i>NEC Class 2</i> power supply to meet the UL requirements!				
	 <p>Use 4 Amp. fuse or Class 2 power supply. See instructions.</p>				
Input current (Us)	180 mA + (total K-bus current)/4				
Starting current (Us)	approx. 2.5 x continuous current				
K-bus current (5 V)	maximum 1450 mA				
Power contact voltage (Up)	24 V _{DC} max. Use a 4 A fuse or an <i>NEC Class 2</i> -compliant power supply to meet the UL requirements.				
	 <p>Use 4 Amp. fuse or Class 2 power supply. See instructions.</p>				
Power contact current load (Up)	maximum 10 A				
Dielectric strength	500 V (power contact/supply voltage/Ethernet/fieldbus)				
Permissible ambient temperature range during operation	-25°C ... +60 °C extended temperature range from hardware 4.4	-25°C ... +60 °C extended temperature range from hardware 4.4	-25°C ... +60 °C extended temperature range from hardware 4.4	-25°C ... +60 °C extended temperature range from hardware 4.4	0°C ... +55 °C
Permissible ambient temperature range during storage	-40°C ... +85 °C extended temperature range from hardware 4.4	-40°C ... +85 °C extended temperature range from hardware 4.4	-40°C ... +85 °C extended temperature range from hardware 4.4	-40°C ... +85 °C extended temperature range from hardware 4.4	-20°C ... +85 °C
Relative humidity	95 % no condensation				
Vibration / shock resistance	conforms to EN 60068-2-6 / EN 60068-2-27				
EMC immunity / emission	conforms to EN 61000-6-2 / EN 61000-6-4				
Protection class	IP20				

Mechanical data	BX3100	BX5100	BX5200	BX8000	BX9000
Weight	approx. 170 g				
Dimensions (W x H x D)	approx. 83 mm x 100 mm x 90 mm (BX8000: approx. 65 mm x 100 mm x 90 mm)				
Mounting	with latch, on mounting rail (35 mm DIN rail)				
Installation position	Any				
Connection cross-section	0.08 mm ² .. 2.5 mm ² AWG 28-14 8-9 mm strip length				

2.4.3 Technical Data - PLC

PLC data	BXxxxx
Programmability	via programming interface (COM1 or COM2) or via fieldbus
Program memory	256 kbyte
Source code memory	256 kbyte
Data memory	256 kbyte
Remanent flags	2 kbyte
PLC cycle time	Approx. 0.85 ms for 1000 IL commands (without I/O cycle)
Programming languages	IEC 6-3 (IL, LD, FBD, ST, SFC)
Propagation delay	1 PLC task (second task in preparation)
Online change	Yes
Up/Down Load Code	Yes/Yes

3 Mounting and wiring

3.1 Mounting

3.1.1 Dimensions

The Beckhoff Bus Terminal system is characterized by low physical volume and high modularity. When planning a project it must be assumed that at least one Bus Coupler and a number of Bus Terminals will be used. The dimensions of the Bus Terminal Controllers are independent of the fieldbus system.

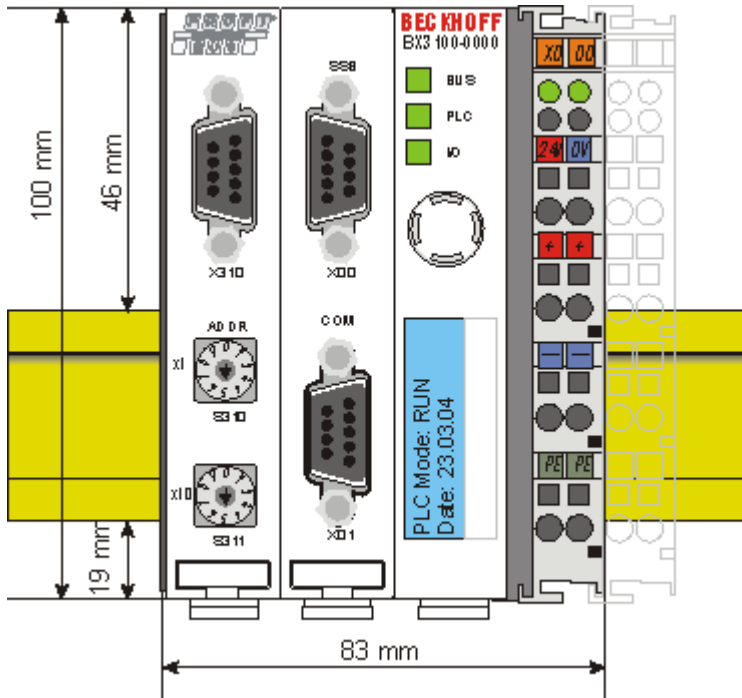

Fig. 3: BX3100, BX5100, BX5200, BX9000

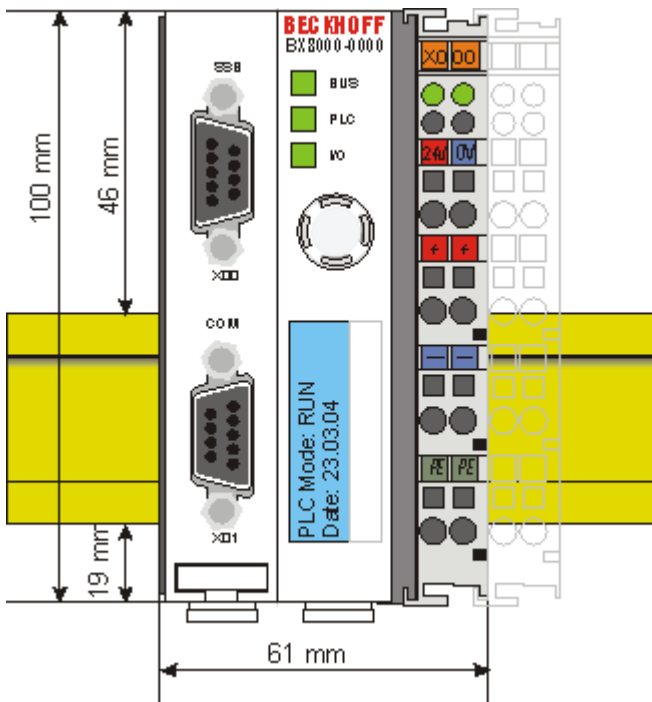

Fig. 4: BX8000

The overall width of the fieldbus station is the width of the Bus Terminal Controller plus the widths of the individual Bus Terminals (including the KL9010 bus end terminal). Depending on design, the Bus Terminals are 12 mm or 24 mm wide. The height is 100 mm.

The BX series Bus Terminal Controllers are up to 83 mm wide and 91 mm deep.

● Pay attention to the total depth

i Note that a Bus Terminal Controller with DIN rail and connected plug connectors is usually higher than the specified value of 91 mm. Example:
 BX3100 + ZB3100 + DIN rail = 105 mm

3.1.2 Installation on mounting rails

Mounting

1. The white pull-tabs on the underside of the BX controller are connected to a latching mechanism. Pull the tabs downwards before pushing the BX controller onto the mounting rail.

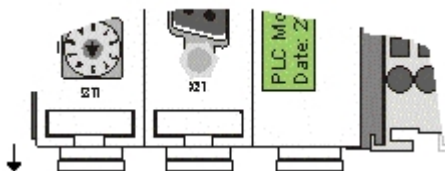

Fig. 5: Released BX controller

NOTE

Avoid damaging the display during the installation!

Avoid pressing on the display when you push the BX controller onto the mounting rail, in order to avoid damaging the display.

2. Now press the BX controller onto the mounting rail.
3. Once it has snapped onto the mounting rail, push the tabs back into their initial position.

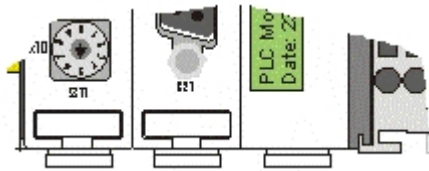

Fig. 6: Latched BX controller

Disassembly

1. First release all pull tabs on the underside of the BX controller.
2. Then pull the orange tab next to the power supply for the power contacts.

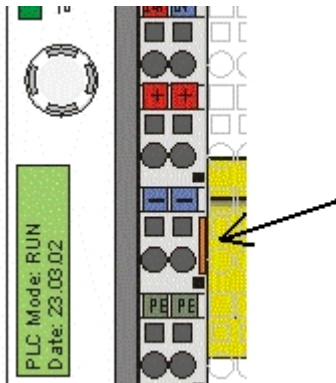

Fig. 7: Disassembly

3.2 Wiring

3.2.1 Potential groups, insulation testing and PE

Potential groups

A Beckhoff Bus Terminal block usually has three different potential groups:

- The fieldbus interface is electrically isolated (except for individual Low Cost couplers) and forms the first potential group.
- Bus Coupler / Bus Terminal Controller logic, K-bus and terminal logic form a second electrically isolated potential group.
- The inputs and outputs are supplied via the power contacts and form further potential groups.

Groups of I/O terminals can be consolidated to further potential groups via potential supply terminals or separation terminals.

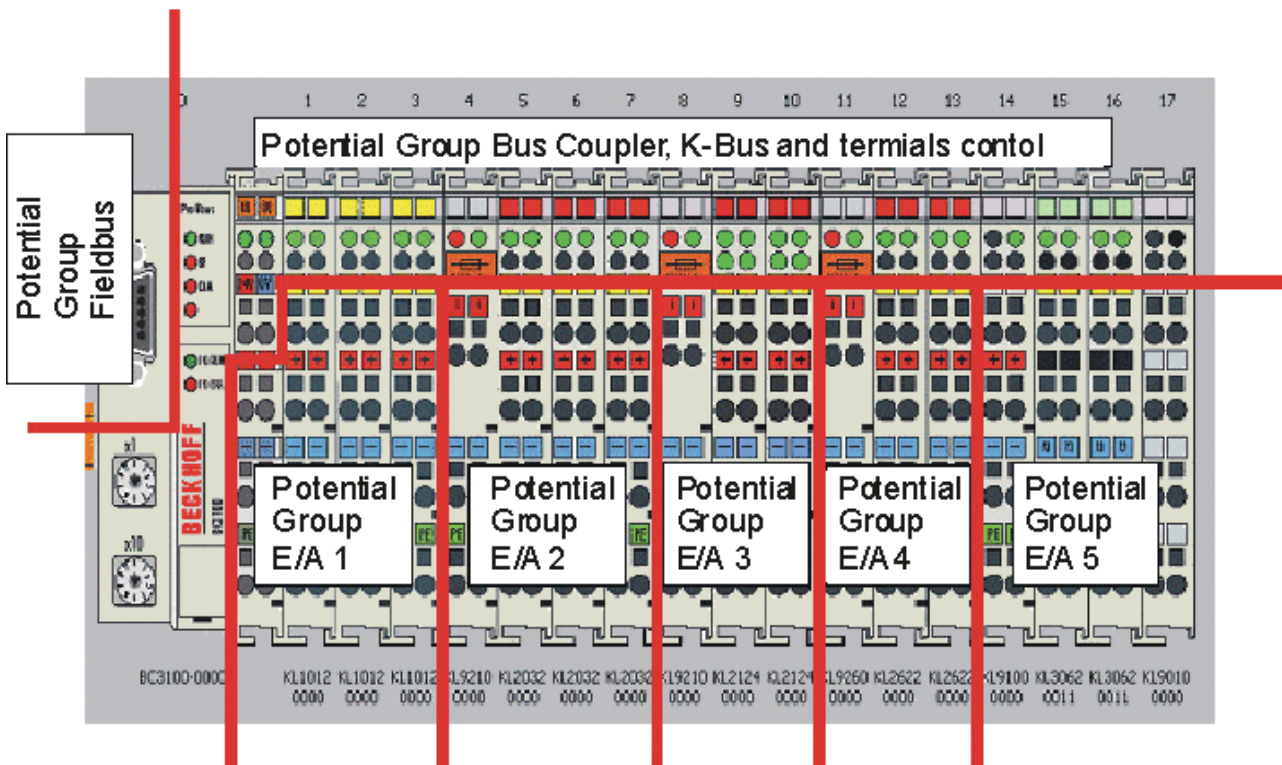

Fig. 8: Potential groups of a Bus Terminal block

Insulation testing

The connection between Bus Coupler / Bus Terminal Controller and Bus Terminals is realized automatically by latching the components. The transfer of the data and the supply voltage for the intelligent electronics in the Bus Terminals is performed by the K-bus. The supply of the field electronics is performed through the power contacts. Plugging together the power contacts creates a supply rail. Since some Bus Terminals (e.g. analog Bus Terminals or 4-channel digital Bus Terminals) are not looped through these power contacts or not completely the Bus Terminal contact assignments must be considered.

The potential feed terminals interrupt the power contacts, and represent the start of a new supply rail. The Bus Coupler / Bus Terminal Controller can also be used for supplying the power contacts.

PE power contacts

The power contact labelled PE can be used as a protective earth. For safety reasons this contact mates first when plugging together, and can ground short-circuit currents of up to 125 A.

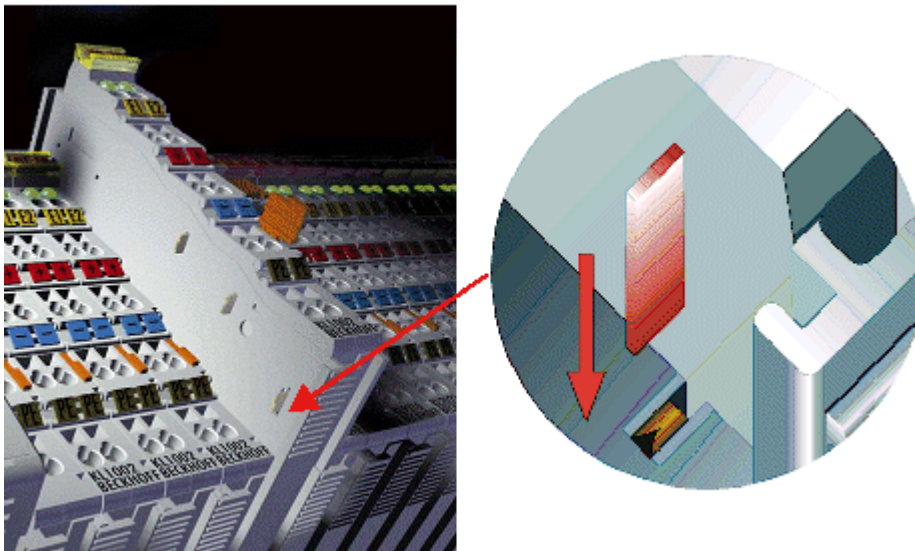

Fig. 9: Power contact on the left

It should be noted that, for reasons of electromagnetic compatibility, the PE contacts are capacitively coupled to the mounting rail. This can both lead to misleading results and to damaging the terminal during insulation testing (e.g. breakdown of the insulation from a 230 V power consuming device to the PE conductor). The PE supply line at the Bus Coupler / Bus Terminal Controller must be disconnected for an insulation test. In order to uncouple further feed locations for the purposes of testing, the feed terminals can be pulled at least 10 mm out from the connected group of other terminals. In that case, the PE conductors do not have to be disconnected.

The power contact with the label PE must not be used for other potentials.

3.2.2 Power supply

⚠ DANGER

Risk of injury through electric shock and damage to the device!

De-energize the Bus Terminal I/O system before you start installation, disassembly or wiring of the components!

⚠ DANGER

Note the UL requirements for the power supply.

These UL requirements apply to all supply voltages of the BX controller (Us and Up)!

To comply with UL requirements, the BX controllers may only be connected to supply voltages (24 V_{DC}) that originate

- from an isolated source protected by a fuse of max. 4A (according to UL248) or
- from a voltage supply complying with NEC class 2.
An NEC class 2 voltage source must not be connected in series or parallel with another NEC class 2 voltage source!

⚠ DANGER

No unlimited voltage sources!

In order to comply with UL requirements, the BX controllers must not be connected to unlimited voltage sources!

Supply of Bus Terminal Controller and Bus Terminals (Us)

The Bus Terminal Controller requires a supply voltage of 24 V_{DC}.

The BX controller is connected via the upper terminal points labelled 24 V and 0 V. This voltage supplies the Bus Terminal Controller electronics, and the Bus Terminal electronics via the K-bus. It is galvanically separated from the field level voltage.

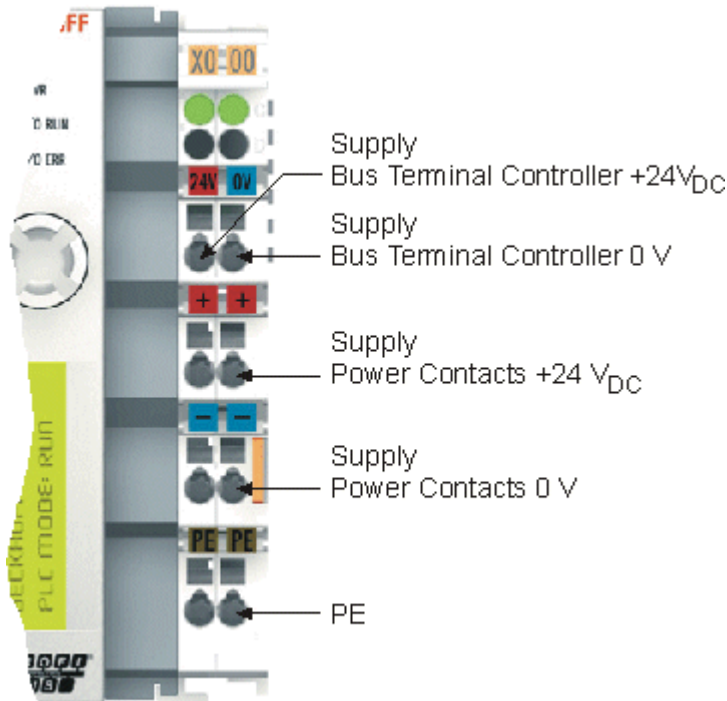

Fig. 10: Terminal points for the Bus Terminal Controller supply

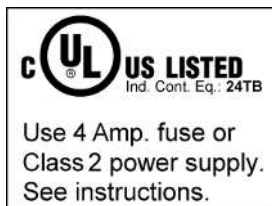

Fig. 11: UL identification

Power contacts supply (Up)

The bottom six connections with spring-loaded terminals can be used to feed the supply for the peripherals. The spring-loaded terminals are joined in pairs to a power contact. The feed for the power contacts has no connection to the voltage supply for the BX electronics. The design of the feed permits voltages of up to 24 V.

The spring-loaded terminals are designed for wires with cross-sections from 0.08 mm² to 2.5 mm².

The assignment in pairs and the electrical connection between feed terminal contacts allows the connection wires to be looped through to various terminal points. The current load from the power contact must not exceed 10 A for long periods. The current carrying capacity between two spring-loaded terminals is identical to that of the connecting wires.

Power contacts

On the right hand face of the Bus Terminal Controller there are three spring contacts for the power contact connections. The spring contacts are hidden in slots so that they cannot be accidentally touched. By attaching a Bus Terminal the blade contacts on the left hand side of the Bus Terminal are connected to the spring contacts. The tongue and groove guides on the top and bottom of the Bus Terminal Controllers and of the Bus Terminals guarantees that the power contacts mate securely.

3.2.3 Programming cable for COM1

You can use a 1:1 cable for programming the BX Controllers (socket/plug, and only connect the pins listed below). On the BX side you need a nine-pin connector, and on the PC side usually a nine-pin socket. The wiring is 1:1, and the necessary pins can be found in the table below. The length of the cable should not exceed 5 meters!

Description	BX COM Port 1	PC COM port RS 232 serial interface
Cable	Plug connector, pin	Socket, pin
RS 232 RxD/TxD	2	2
RS 232 RxD/TxD	3	3
GND	5	5

NOTE

All pins that are not listed in the table are reserved

Please note that pins that are not listed are not freely available at this COM port [▶ 25], but are reserved for other signals.

ZK1000-0030

The programming cable can be used to program the BX controller via the COM 1 interface and connect another serial device at the COM 2 interface. Once installed, make sure the maximum overall height of the plug connector is not exceeded.

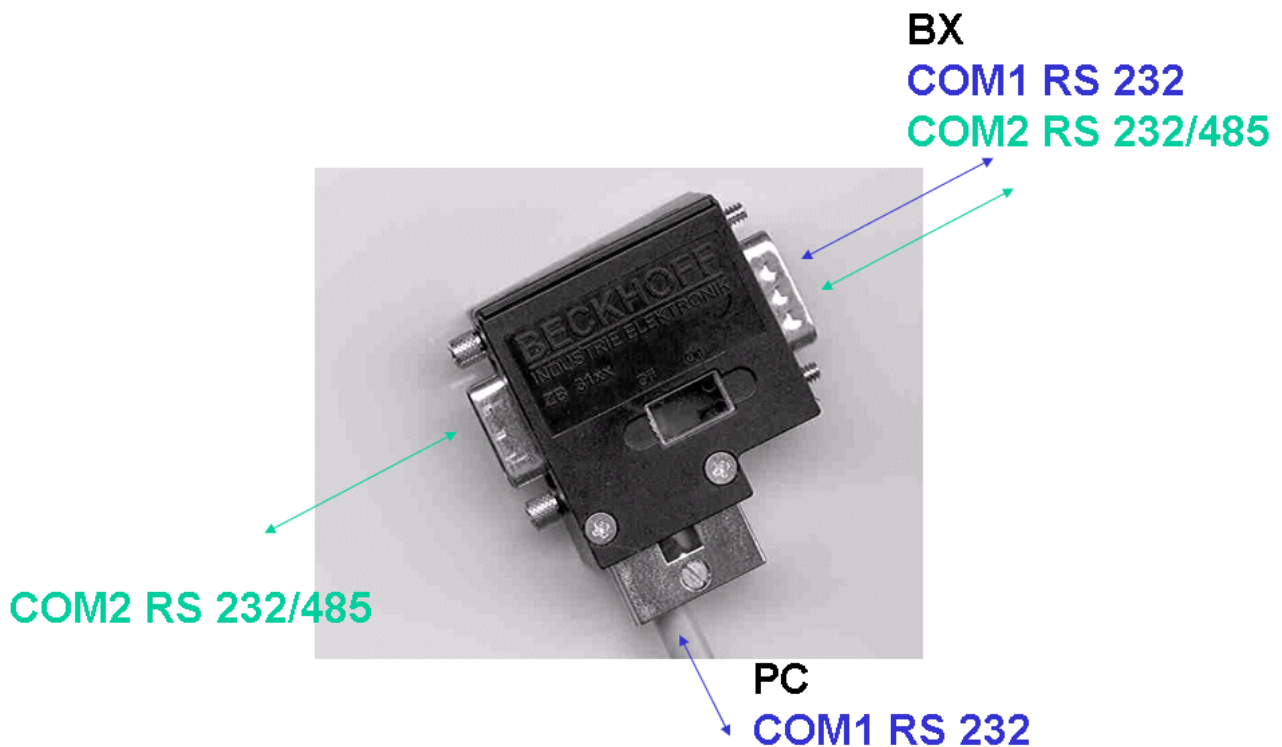

Fig. 12: Programming cable ZK1000-0030 - COM 1 and COM 2

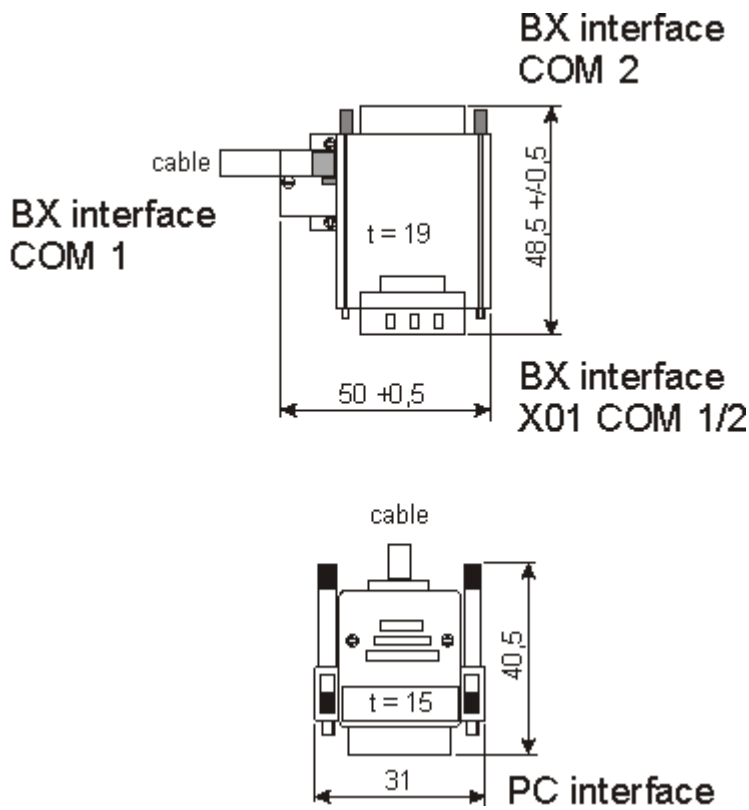

Fig. 13: Programming cable ZK1000-0030 - plug connector dimensions

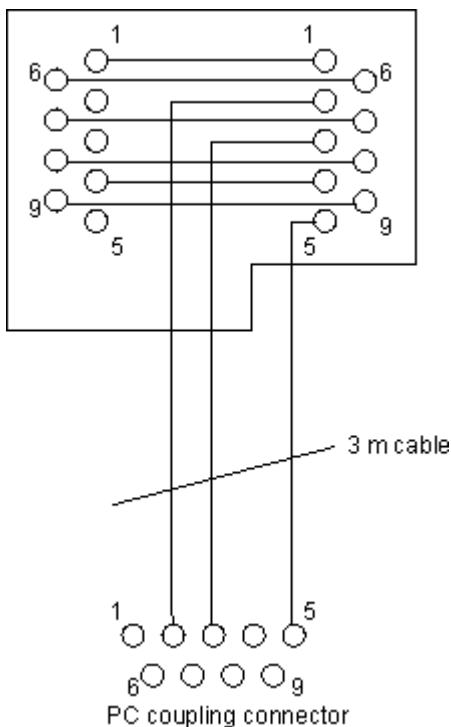

Fig. 14: Programming cable ZK1000-0030 - Pinning

3.2.4 SSB and COM interface

The basic BX controller module the COM1, COM2 and SSB (Smart System Bus) interfaces. A D-sub socket is used for COM1 and COM2. A special programming cable (ZK1000-0030) for connecting the two interfaces is available from Beckhoff. The COM2 interface is intended for the connection of serial devices. For the COM2 interface, you can choose between RS232 or RS485.

Libraries [[▶ 101](#)] are available for the serial COM2 interface.

SSB interface

Fig. 15: SSB interface

SSB interface assignment (plug connector X00)

PIN	Signal
1	reserved
2	CAN low
3	GND
4	reserved
5	Shield
6	GND
7	CAN high
8	reserved
9	reserved

COM1 (RS 232) and COM2 (RS 232/485) interface

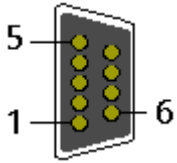
Fig. 16: COM1 (RS 232) and COM2 (RS 232/485) interface

COM interface assignment (socket X01)

PIN	Interface	Signal
1	COM2	RS485 D+
2	COM1	RS232 TxD
3	COM1	RS232 RxD
4	VCC +5 V	VCC
5	GND	GND
6	COM2	RS485 D-
7	COM2	RS232 RxD
8	COM2	RS232 TxD
9	GND	GND

3.2.5 CANopen cabling

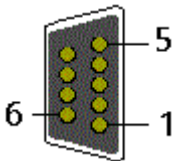
Notes related to checking the CAN wiring can be found in the Trouble Shooting section.

3.2.5.1 CAN topology

CAN is a 2-wire bus system, to which all participating devices are connected in parallel (i.e. using short drop lines). The bus must be terminated at each end with a 120 (or 121) Ohm terminating resistor to prevent reflections. This is also necessary even if the cable lengths are very short!

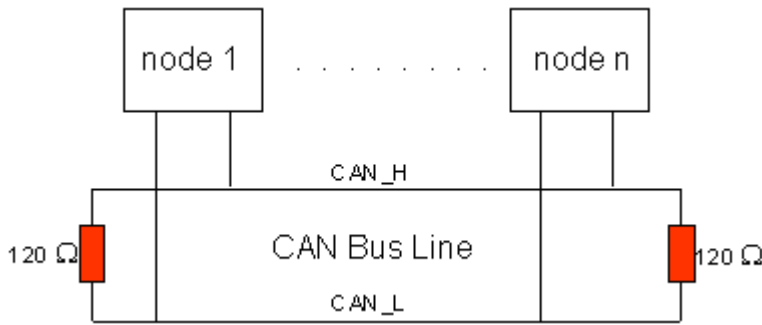

Fig. 17: Termination of the bus with a 120 Ohm termination resistor

Since the CAN signals are represented on the bus as the difference between the two levels, the CAN leads are not very sensitive to incoming interference (EMI): Both leads are affected, so the interference has very little effect on the difference.

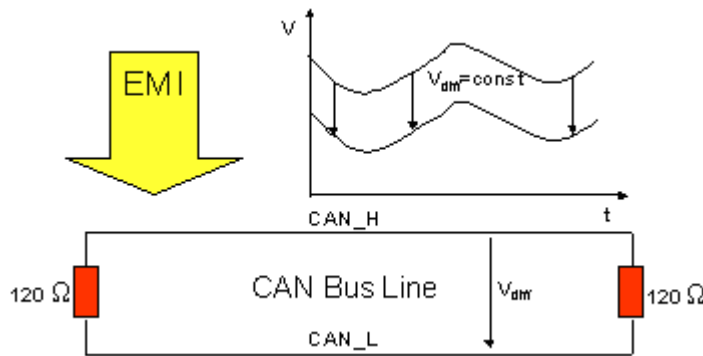

Fig. 18: Insensitivity to incoming interference

3.2.5.2 Bus length

The maximum length of a CAN bus is primarily limited by the signal propagation delay. The multi-master bus access procedure (arbitration) requires signals to reach all the nodes at effectively the same time (before the sampling within a bit period). Since the signal propagation delays in the CAN connecting equipment (transceivers, opto-couplers, CAN controllers) are almost constant, the line length must be chosen in accordance with the baud rate:

Baud rate	Bus length
1 Mbit/s	< 20 m*
500 kbit/s	< 100 m
250 kbit/s	< 250 m
125 kbit/s	< 500 m
50 kbit/s	< 1000 m
20 kbit/s	< 2500 m
10 kbit/s	< 5000 m

*) A figure of 40 m at 1 Mbit/s is often found in the CAN literature. This does not, however, apply to networks with optically isolated CAN controllers. The worst case calculation for opto-couplers yields a figure 5 m at 1 Mbit/s - in practice, however, 20 m can be reached without difficulty.

It may be necessary to use repeaters for bus lengths greater than 1000 m.

3.2.5.3 Drop lines

Drop lines must always be avoided as far as possible, since they inevitably cause reflections. The reflections caused by drop lines are not however usually critical, provided they have decayed fully before the sampling time. In the case of the bit timing settings selected in the Bus Couplers it can be assumed that this is the case, provided the following drop line lengths are not exceeded:

Baud rate	Drop line length	Total length of all drop lines
1 Mbit/s	< 1 m	< 5 m
500 kbit/s	< 5 m	< 25 m
250 kbit/s	< 10 m	< 50 m
125 kbit/s	< 20 m	< 100 m
50 kbit/s	< 50 m	< 250 m

Drop lines must not have terminating resistors.

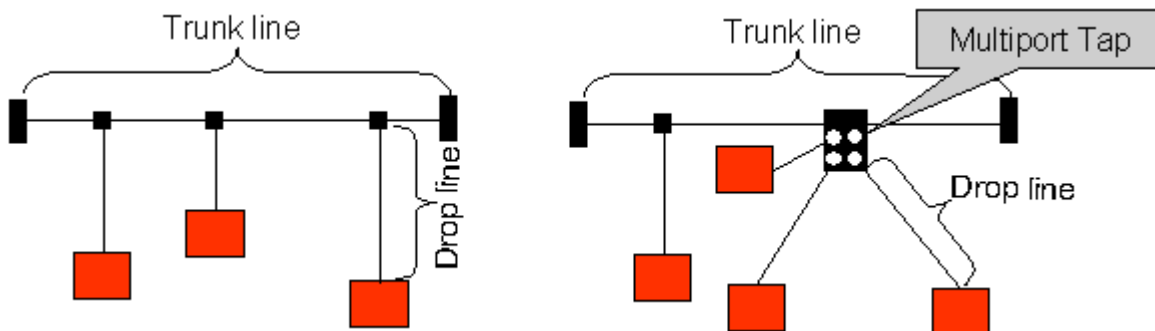

Fig. 19: Sample topology of drop lines

3.2.5.4 Star Hub (Multiport Tap)

Shorter drop line lengths must be maintained when passive distributors ("multiport taps"), such as the Beckhoff ZS5052-4500 Distributor Box. The following table indicates the maximum drop line lengths and the maximum length of the trunk line (without the drop lines):

Baud rate	Drop line length with multiport topology	Trunk line length (without drop lines)
1 Mbit/s	< 0,3 m	< 25 m
500 kbit/s	< 1,2 m	< 66 m
250 kbit/s	< 2,4 m	< 120 m
125 kbit/s	< 4,8 m	< 310 m

3.2.5.5 CAN cable

Screened twisted-pair cables (2x2) with a characteristic impedance of between 108 and 132 Ohm is recommended for the CAN wiring. If the CAN transceiver's reference potential (CAN ground) is not to be connected, the second pair of conductors can be omitted. (This is only recommended for networks of small physical size with a common power supply for all the participating devices).

ZB5100 CAN Cable

A high quality CAN cable with the following properties is included in Beckhoff's range:

- 2 x 2 x 0.25 mm² (AWG 24) twisted pairs, cable colors: red/black + white/black
- double screened
- braided screen with filler strand (can be attached directly to pin 3 of the 5-pin connection terminal)
- flexible (minimum bending radius 35 mm when bent once, 70 mm for repeated bending)

- characteristic impedance (60 kHz): 120 ohm
- conductor resistance < 80 Ohm/km
- sheath: grey PVC, outside diameter 7.3 +/- 0.4 mm
- Weight: 64 kg/km.
- printed with "Beckhoff ZB5100 CAN-BUS 2x2x0.25" and meter marking (length data every 20cm)

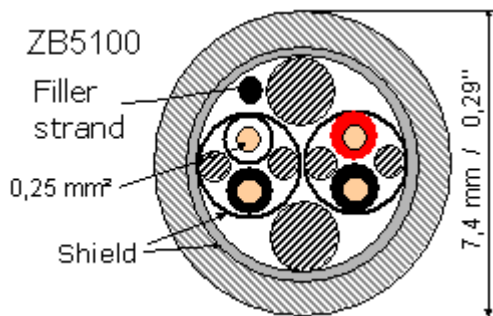

Fig. 20: Structure of CAN cable ZB5100

ZB5200 CAN/DeviceNet Cable

The ZB5200 cable material corresponds to the DeviceNet specification, and is also suitable for CANopen systems. The ready-made ZK1052-xxxx-xxxx bus cables for the Fieldbus Box modules are made from this cable material. It has the following specification:

- 2 x 2 x 0.34 mm² (AWG 22) twisted pairs
- double screened, braided screen with filler strand
- characteristic impedance (1 MHz): 126 ohm
- Conductor resistance 54 Ohm/km
- sheath: grey PVC, outside diameter 7.3 mm
- printed with "InterlinkBT DeviceNet Type 572" as well as UL and CSA ratings
- stranded wire colors correspond to the DeviceNet specification
- UL recognized AWM Type 2476 rating
- CSA AWM I/II A/B 80°C 300V FT1
- corresponds to the DeviceNet "Thin Cable" specification

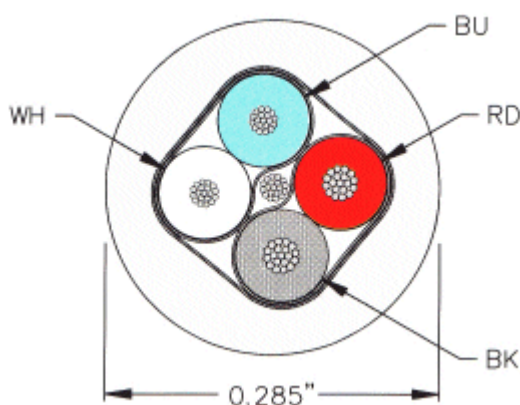

Fig. 21: Structure of CAN/DeviceNet cable ZB5200

3.2.5.6 Shielding

The screen is to be connected over the entire length of the bus cable, and only galvanically grounded at one point, in order to avoid ground loops. The design of the screening, in which HF interference is diverted through R/C elements to the mounting rail

assumes that the rail is appropriately earthed and free from interference. If this is not the case, it is possible that HF interference will be transmitted from the mounting rail to the screen of the bus cable. In that case the screen should not be attached to the couplers - it should nevertheless still be fully connected through.

Notes related to checking the CAN wiring can be found in the Trouble Shooting section.

3.2.5.7 Cable colors

Suggested method of using the Beckhoff CAN cable on Bus Terminal and Fieldbus Box:

BK51x0 pin PIN BX5100 (X510)	Pin BK5151 CX8050, CX8051, CXxxxx-B510/M510	Fieldbus Box pin	Pin FC51xx	Function	ZB5100 cable color	ZB5200 ca- ble color
1	3	3	3	CAN Ground	black/ (red)	black
2	2	5	2	CAN Low	black	blue
3	5	1	5	Shield	Filler strand	Filler strand
4	7	4	7	CAN high	white	white
5	9	2	9	not used	(red)	(red)

3.2.5.8 BK5151, FC51xx, CX with CAN interface and EL6751: D-sub, 9 pin

The CANbus cable is connected to the FC51x1, FC51x2 CANopen cards and in the case of the EL6751 CANopen master/slave terminal via 9-pin Sub-D sockets with the following pin assignment.

Pin	Assignment
2	CAN low (CAN-)
3	CAN ground (internally connected to pin 6)
6	CAN ground (internally connected to pin 3)
7	CAN high (CAN+)

The unlisted pins are not connected.

The mounting rail contact spring and the plug shield are connected together.

Note: an auxiliary voltage of up to 30 V_{DC} may be connected to pin 9. Some CAN devices use this to supply the transceiver.

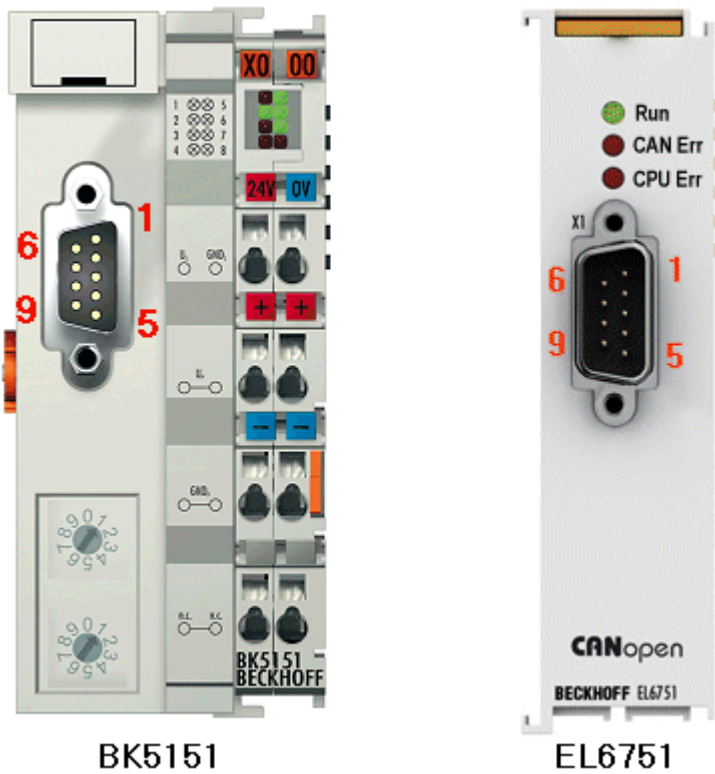

Fig. 22: BK5151, EL6751 pin assignment

FC51x2:

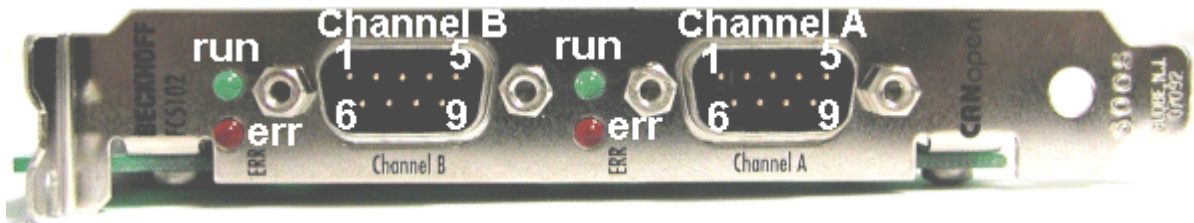

Fig. 23: FC51x2

3.2.5.9 BK51x0/BX5100: 5-pin open style connector

The BK51x0/BX5100 (X510) Bus Couplers have a recessed front surface on the left hand side with a five pin connector.

The supplied CANopen socket can be inserted here.

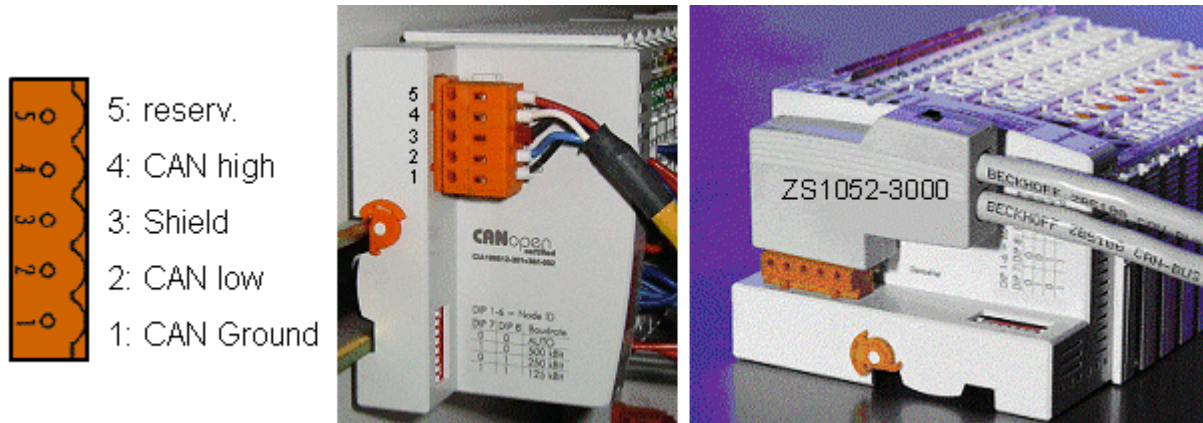

Fig. 24: BK51x0/BX5100 socket assignment

The left figure shows the socket in the BK51x0/BX5100 Bus Coupler. Pin 5 is the connection strip's top most pin. Pin 5 is not used. Pin 4 is the CAN high connection, pin 2 is the CAN low connection, and the screen is connected to pin 3 (which is connected to the mounting rail via an R/C network). CAN-GND can optionally be connected to pin 1. If all the CAN ground pins are connected, this provides a common reference potential for the CAN transceivers in the network. It is recommended that the CAN GND be connected to earth at one location, so that the common CAN reference potential is close to the supply potential. Since the CANopen BK51X0/BX5100 Bus Couplers provide full electrical isolation of the bus connection, it may in appropriate cases be possible to omit wiring up the CAN ground.

ZS1052-3000 Bus Interface Connector

The ZS1052-3000 CAN Interface Connector can be used as an alternative to the supplied connector. This makes the wiring significantly easier. There are separate terminals for incoming and outgoing leads and a large area of the screen is connected via the strain relief. The integrated terminating resistor can be switched externally. When it is switched on, the outgoing bus lead is electrically isolated - this allows rapid wiring fault location and guarantees that no more than two resistors are active in the network.

3.2.5.10 LC5100: Bus connection via spring-loaded terminals

In the low cost LC5100 Coupler, the CAN wires are connected directly to the contact points 1 (CAN-H, marked with C+) and 5 (CAN-L, marked with C-). The screen can optionally be connected to contact points 4 or 8, which are connected to the mounting rail via an R/C network.

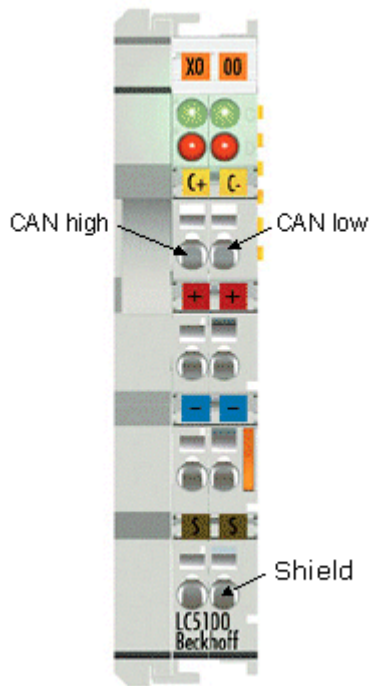

Fig. 25: LC5100

NOTE

Risk of device damage!

On account of the lack of electrical isolation, the CAN driver can be destroyed or damaged due to incorrect cabling. Always carry out the cabling in the switched-off condition. First connect the power supply and then the CAN. Check the cabling and only then switch on the voltage.

3.2.5.11 Fieldbus Box: M12 CAN socket

The IPxxxx-B510, IL230x-B510 and IL230x-C510 Fieldbus Boxes are connected to the bus using 5-pin M12 plug-in connectors.

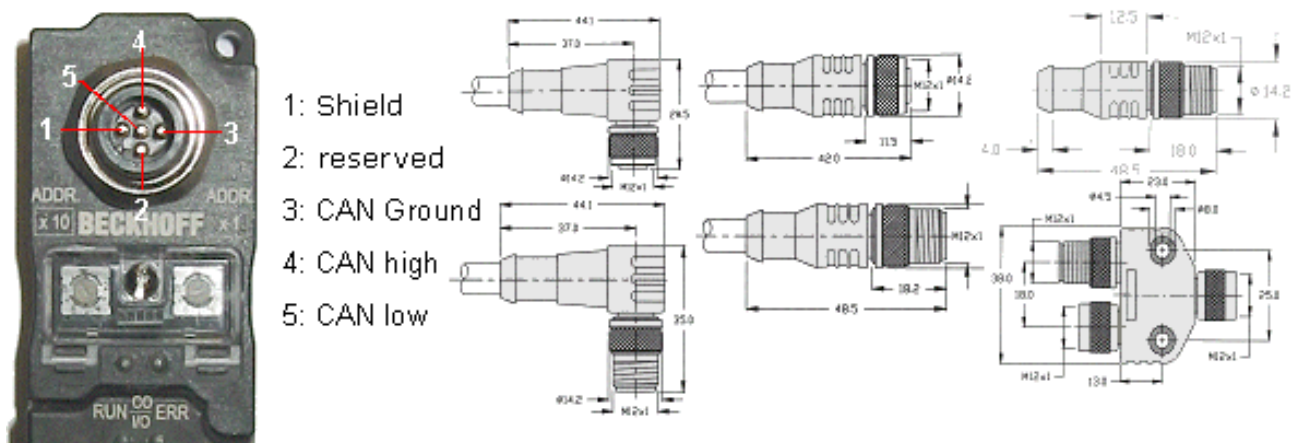

Fig. 26: Pin assignment: M12 plug, fieldbus box

Beckhoff offer plugs for field assembly, passive distributor's, terminating resistors and a wide range of pre-assembled cables for the Fieldbus Box system. Details be found in the catalogue, or under www.beckhoff.de.

4 Parameterization and Commissioning

4.1 Start-up behavior of the Bus Terminal Controller

When the Bus Terminal Controller is switched on it checks its state, configures the K-bus, creates a configuration list based on the connected Bus Terminals and starts its local PLC.

The I/O LEDs flash when the Bus Terminal Controller starts up. If the system is in an error-free state, the I/O LEDs should stop flashing after approx. 2-3 seconds. In the event of a fault the error type determines which LED flashes (see chapter *Diagnostic LEDs*).

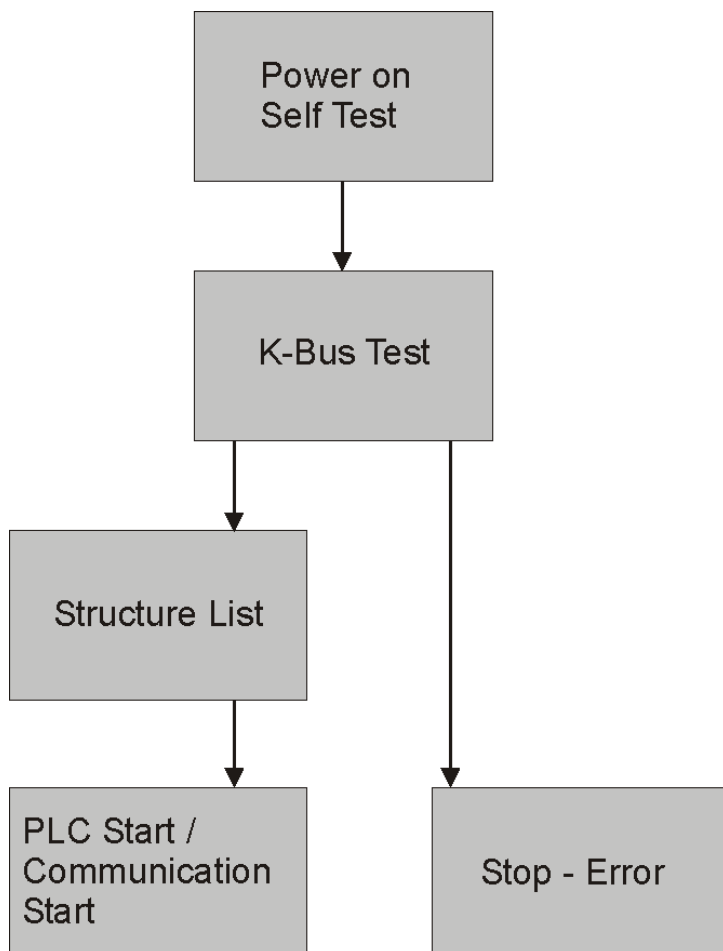

Fig. 27: Start-up behavior of the Bus Terminal Controller

4.2 Configuration

4.2.1 Overview

Configuration types

The Bus Terminal controllers of the BCxx50, BCxx20 and BXxx00 series can be configured in two different ways: DEFAULT CONFIG or TwinCAT CONFIG.

DEFAULT-CONFIG

Bus Terminals are mapped in the order they are inserted, i.e. first the complex Bus Terminals followed by the digital Bus Terminals.

The complex Bus Terminals are mapped as follows:

- Word Alignment
- complex representation

⚠ CAUTION

The process image depends on the connected terminals!

The process image changes when a terminal is added or removed!

The data of the fieldbus slaves interface are referred to as PLC variables. The PLC variables have addresses from %QB1000 and %IB1000

The DEFAULT CONFIG (without PLC program) can also be used for writing and testing of the Connected Bus Terminals. To this end, the Bus Terminal Controller must be scanned in the System Manager, and FreeRun mode must be enabled (to use this function, no PLC program may be active on the Bus Terminal Controller).

TWINCAT-CONFIG

In the TwinCAT CONFIG the Bus Terminals and PLC variables can be freely linked as required (TwinCAT System Manager file required). The configuration is transferred to the coupler via the System Manager and ADS.

The following is required for the TwinCAT configuration (TC file):

- Via the fieldbus (PROFIBUS, CANopen, Ethernet)
 - PROFIBUS: (BC3150, BX3100)
 - PC with FC310x from version 2.0 and TwinCAT 2.9 build 1000
 - BX3100 with CIF60 or CP5412
 - TwinCAT 2.9 build 946
(**NOTE:** with PROFIBUS cards from Hilscher only one ADS communication is permitted, i.e. either System Manager or PLC Control)
 - CANopen: (BC5150, BX5100)
 - PC with FC510x from version 1.76 TwinCAT build 1030
 - DeviceNet: (BC5250, BX5200)
 - on request
 - Ethernet: (BC9050, BC9020, BC9120, BX9000)
 - PC with TwinCAT 2.10 build 1322
 - Via the serial ADS TwinCAT 2.9 build 1010
 - BX3100 version 1.00
 - BX5100 version 1.00
 - BX5200 version 1.10
 - BX8000 version 1.00
 - BC3150, BC5150, BC5250, BC9050, BC9020, BC9120 from firmware B0
 - For BC8150 from TwinCAT 2.10 build 1243

BCxx50 and BXxx00 can be parameterized via the System Manager of the TwinCAT program.

- Variable I/O mapping
- Type-specific PROFIBUS data (BC3150 and BX3100 only)
- RTC (real-time clock) (BX series only)
- SSB (Smart System Bus) (BX series only)
- PLC settings
- K-Bus settings

The configuration can be transferred to the BCxx50 or BXxx00 via fieldbus ADS protocol or serial ADS protocol.

The TwinCAT configuration can be used to link variables, I/Os and data. The following is possible:

- PLC - K-BUS
- PLC fieldbus (e.g. PROFIBUS slave interface to PLC)
- K-bus fieldbus (only for BX controllers)
- Support for TwinSAFE terminals (only BX controllers from firmware 1.17)

In addition, the TwinCAT configuration can be used to parameterize special behavior, for example whether data are preserved or set to "0" in the event of a fieldbus error.

The real-time clock can be set via a tab in the system manager.

Work steps

1. Setting the fieldbus address
2. Open the System Manager and create a TC file
3. Configure fieldbus data in the TC file
4. Save the TC file
5. Opening a new system manager, creating a PC file and reading in saved TX file
6. Creating a link to a PLC task
7. Saving the configuration
8. Starting the TwinCAT system
9. Open the TC file in the System Manager, complete the configuration and transfer it to the BCxx50, BCxx20 or BXxx00
10. Transfer the program to BCxx50, BCxx20 or BXxx00
11. Creating a boot project

4.2.2 Creating a TwinCAT configuration

In order to configure a Bus Terminal Controller of the BCxx50, BCxx20 or BXxx00 series, create a BX file in the System Manager. To simplify matters, files for the basic units have already been prepared. Open the corresponding Bus Terminal Controller with *New from Template*.

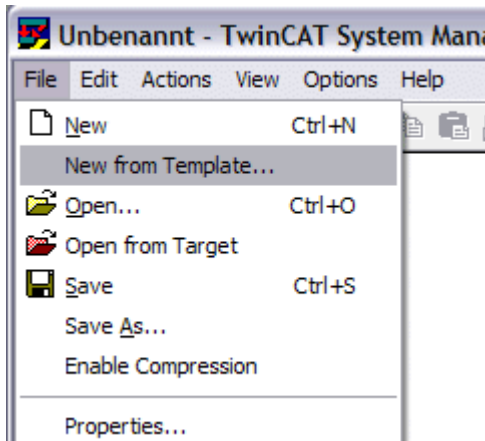

Fig. 28: Creating a TwinCAT configuration

Select the corresponding Bus Terminal Controller.

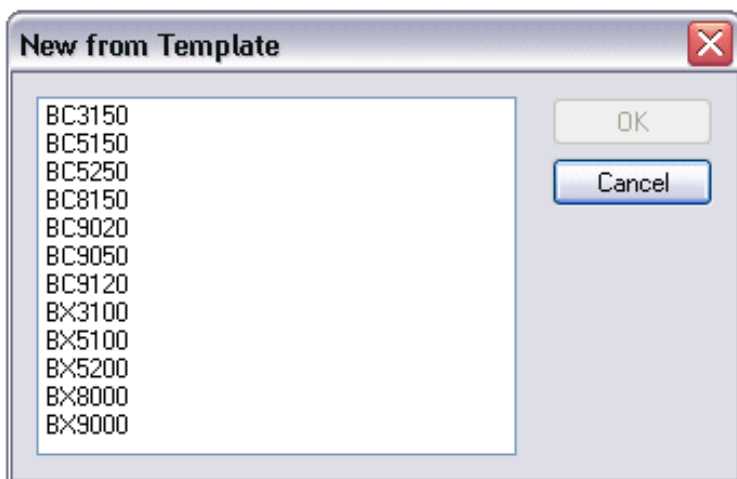

Fig. 29: Selecting the Bus Terminal Controller

All Bus Terminal Controller components are now available:

- Fieldbus interface
- [K-bus interface \[▶ 48\]](#)
- [PLC Program \[▶ 50\]](#)
- [SSB \[▶ 53\]](#) (only Bus Terminal Controllers of the BX series)

Please refer to the relevant chapter for device configuration.

4.2.3 Downloading a TwinCAT configuration

The TwinCAT configuration is loaded into the Bus Terminal Controller via ADS protocol.

Serial ADS protocol

(all Bus Terminal Controllers of the BXxx00 and BCxx50 series)

Enter the serial ADS connection, as described in the chapter [Serial ADS \[▶ 43\]](#).

ADS protocol via the fieldbus

(BC3150, BC5150, BC9x20, BC9050, BX3100, BX5100, BX9000 only)

A prerequisite is that TwinCAT operates as master and is engaged in data exchange, i.e. the physical and fieldbus configuration must be complete, and data exchange must take place between the master (e.g. fieldbus master card) and the Bus Terminal Controller.

Choose Target System

Select the Bus Terminal Controller onto which the configuration is to be loaded. Use the function key F8 to open the dialog for downloading your file to the corresponding device.

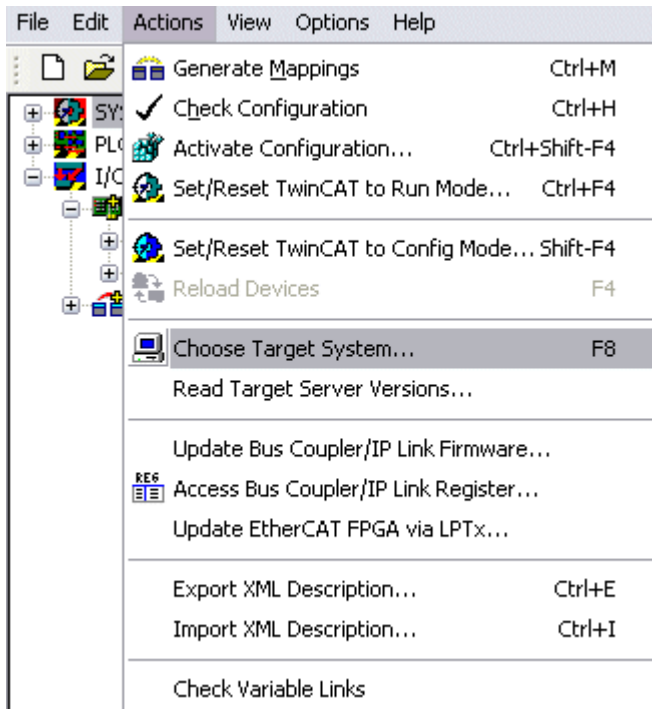

Fig. 30: Downloading a TwinCAT configuration

Select the corresponding Bus Terminal Controller.

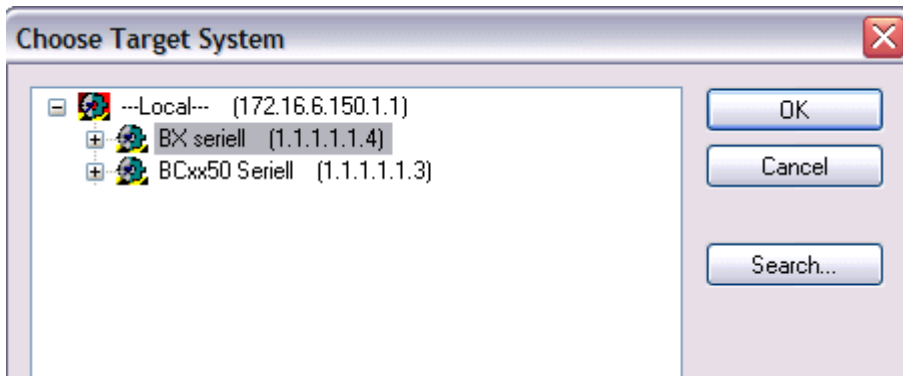

Fig. 31: Selecting the Bus Terminal Controller

The state of the Bus Terminal Controller is shown at the bottom right of the System Manager.

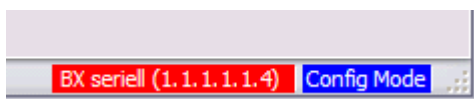

Fig. 32: State of the Bus Terminal Controller

In *Config mode / FreeRun* the configuration can now be downloaded to Bus Terminal Controller. If the Bus Terminal Controller is in *Stop mode*, ADS communication is not yet activated. In this case, it is not possible to download the configuration.

To activate the TwinCAT configuration select Ctrl+Shift+F4 or *Activate Configuration*.

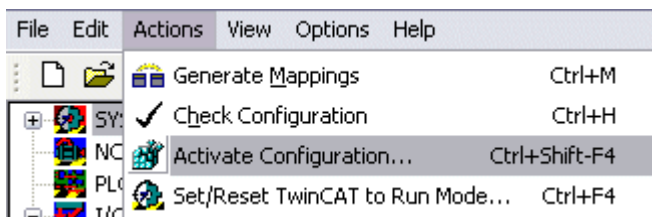

Fig. 33: Activating the TwinCAT configuration

The current configuration is loaded onto the Bus Terminal Controller. The display will show *Store Config*, and the BUS and I/O LED will flash. Once the configuration is successfully loaded onto Bus Terminal Controller, *TwinCAT Config* should appear in the display of a BXxx00. The corresponding program can now be transferred to the Bus Terminal Controller (program-download via the fieldbus).

4.2.4 Uploading a TwinCAT configuration

The TwinCAT configuration is loaded into the Bus Terminal Controller via ADS protocol.

Serial ADS protocol

(all Bus Terminal Controllers of the BCxx50, BCxx20 and BXxx00 series)

Enter the serial ADS connection, as described in the chapter [Serial ADS](#) [▶ 43].

ADS protocol via the fieldbus

(BC3150, BC5150, BC9x20, BC9050, BX3100, BX5100, BX9000 only)

A prerequisite is that TwinCAT operates as master and is engaged in data exchange, i.e. the physical and fieldbus configuration must be complete, and data exchange must take place between the master (e.g. fieldbus card) and the Bus Terminal Controller.

Choose Target System

Select the Bus Terminal Controller onto which the configuration is to be loaded. Use the function key [F8] to open the dialog for downloading your file to the corresponding device.

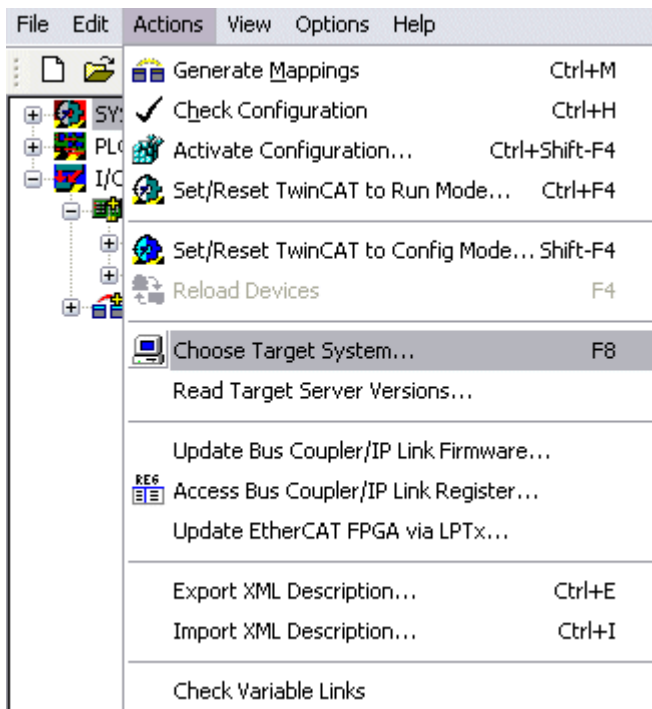

Fig. 34: Choose Target System

Select the corresponding Bus Terminal Controller.

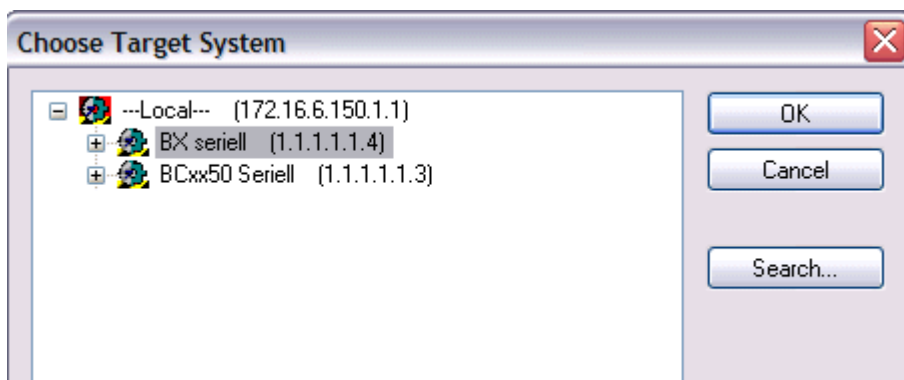

Fig. 35: Selecting the Bus Terminal Controller

The state of the Bus Terminal Controller is shown at the bottom right of the System Manager.

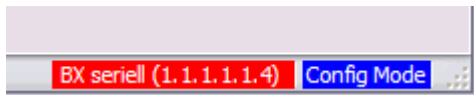

Fig. 36: State of the Bus Terminal Controller

Click on the red folder. The TwinCAT configuration will now be uploaded.

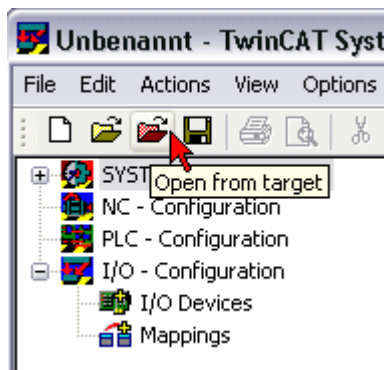

Fig. 37: Uploading the TwinCAT configuration

4.2.5 Resources in the Bus Terminal Controller

The memory resources assigned in the Bus Terminal Controller are shown in the System Manager in the *Resources* tab of the Bus Terminal Controller.

Mapping code

The mapping code is required for calculating the TwinCAT configuration (see Figure *Memory for the code mapping*). The percentages are added here. In the example from Fig. *Memory for code mapping*, 8% of the memory is allocated to the mapping calculation.

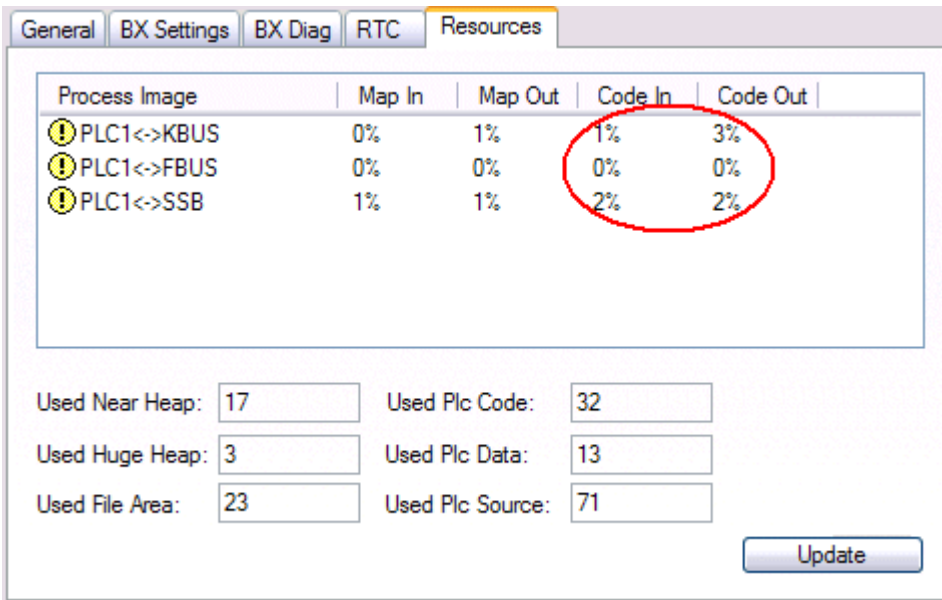

Fig. 38: Memory for code mapping

Data memory mapping

Data memory for mapping. The values are to be considered individually, i.e. each value can be up to 100%.

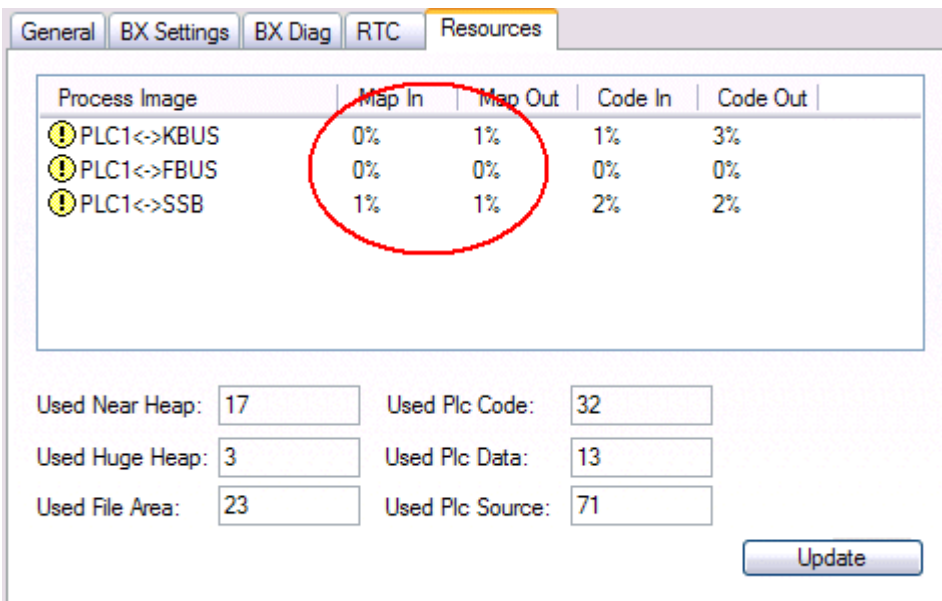

Fig. 39: Data memory mapping

Used code and data memory

Fig. Code and data memory (1) "Used PLC code" in %.

Fig. Code and data memory (2) "Used PLC data" in %.

Fig. Code and data memory (3) "Used PLC source" in %.

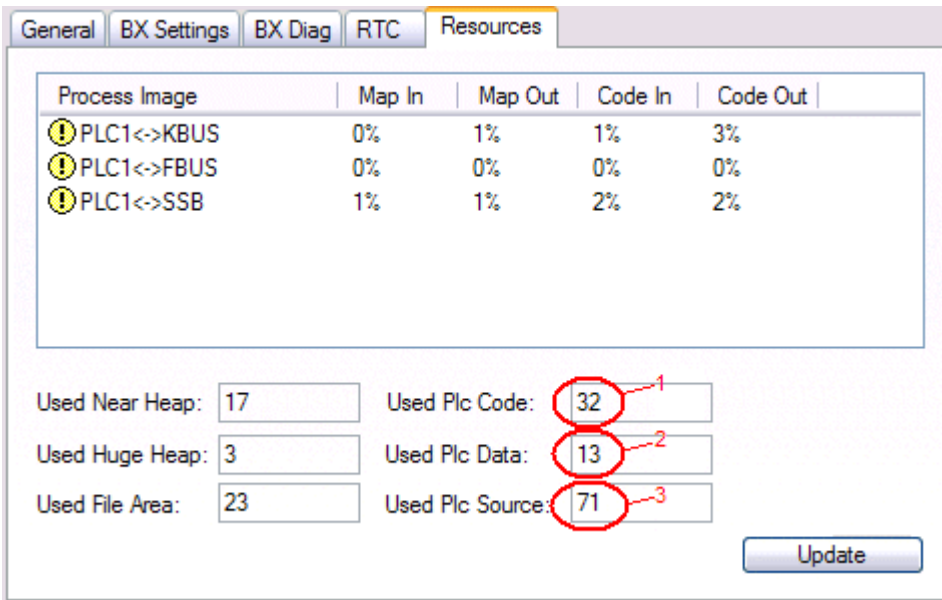

Fig. 40: Code and data memory

Other memory

Fig. *Other Memory* (1) "Used Near Heap" is required for the COM interface and SSB. % values.

Fig. *Other Memory* (2) "Used Huge Heap" is required for the ADS communication. % values. This value should be less than 30 %.

Fig. *Other Memory* (3) "Used File Area" is required for the TwinCAT configuration, the TSM file and the 16 kbyte flash access. % values.

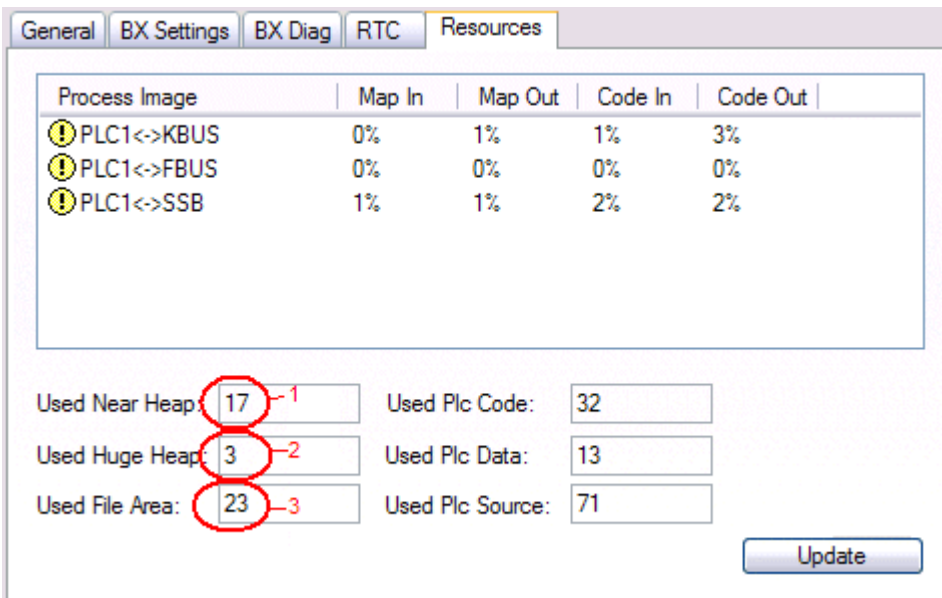

Fig. 41: Other memory

4.2.6 ADS connection via serial interface

(from firmware version 1.xx or 0.99x, Bus Terminal Controllers of the BX series and for all BCxx50)

From TwinCAT 2.9 build 1020 (TwinCAT level PLC, NC or NCI)

● Use only a serial connection

i To ensure trouble-free operation of the ADS link via the serial interface, only a serial connection to the BX controller is allowed.
After successful configuration via the System Manager, close the System Manager before starting programming.

● AMS Net ID in delivery state (default)

i For BX9000

The default AMS Net ID is 172.16.21.20.1.1. If the IP address of the BX9000 is changed, the AMS Net ID of the BX9000 also changes. There is a menu option for displaying the current AMS Net ID. Example: If you change the IP address to 10.2.3.7, the AMS Net ID changes to 10.2.3.7.1.1.

For BC9050, BC9020, BC9120

The default AMS Net ID is 172.16.xxx.[DIP switch].1.1. If the IP address of the BX9xxx is changed, the AMS Net ID of the BX9xxx also changes.

Example: If you change the IP address to 10.2.3.7, the AMS Net ID changes to 10.2.3.7.1.1.

BC9050: DEFAULT 172.16.21.[DIP-Switch].1.1

BC9020: DEFAULT 172.16.22.[DIP-Switch].1.1

BC9120: DEFAULT 172.16.23.[DIP-Switch].1.1

Initializing the ADS connection

Enter the Bus Terminal Controller in the remote connection under TwinCAT. Click on the TwinCAT icon and open the features menu. The following settings can be made under the >AMS Remote< tab.

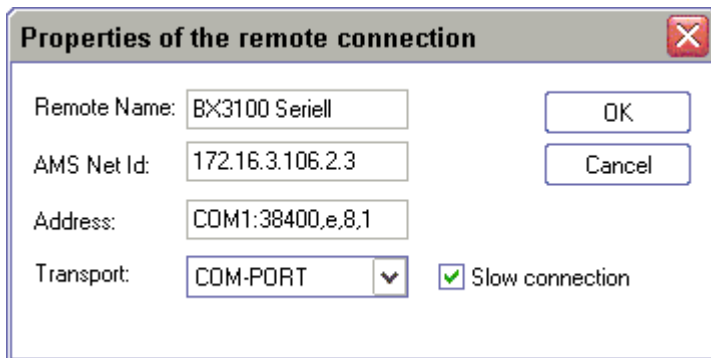

Fig. 42: Properties of the remote connection

Remote Name: Any
 AMS-Net-ID: 1.1.1.1.1.1 (Default)
 Address: COM Port: Baud rate, parity, data bits, stop bits
 Transport: Select "COM port"

When the Bus Terminal Controller is switched on, the default AMS Net ID is always "1.1.1.1.1" (except all Ethernet Controllers).

The AMS Net ID can be changed as required. Please note that the new AMS Net ID cannot be changed again in this way.

If you need to change the new AMS Net ID again, you have to restart the Bus Terminal Controller, so that the AMS Net ID is reset to the default AMS Net ID, "1.1.1.1.1".

You can now change the AMS Net ID again.

● Strings can only be entered at the second call

i No strings can be entered under address when the dialog is first called (see above). Enter the name, AMS Net ID and transport type and close the dialog. With the second call you can enter your COM port.

The communication starts when TwinCAT is in Config mode (TwinCAT icon is blue) or RUN mode (TwinCAT icon is green). The COM interface remains open until a TwinCAT stop occurs (TwinCAT icon is red). It is then available again for other programs. No error message is issued if the COM interface is used by another program during a TwinCAT restart (e.g. by the KS2000 configuration software).

● AMS Net ID after ADS connection via the fieldbus

i If you have addressed the Bus Terminal Controller with an ADS connection via the fieldbus before the serial ADS was used, the AMS Net ID was automatically changed by the System Manager. In this case a new serial ADS connection is only possible, if the AMS Net ID is adjusted.

BX series: reading the AMS Net ID

The current AMS Net ID can be read from the menu via the display of BX series Bus Terminal Controller.

```
AMS          AMS Net ID
1.1.1.1.1.1
```

4.2.7 CANopen slave interface

4.2.7.1 CANopen slave interface

There are two types of configuration. In the default configuration (delivery state) the CANopen data of the CANopen Slave interface map from the address 1000 of the BX5100/BC5150 and the first 4 PDOs are activated. In the TwinCAT configuration, any required configuration can be created via the System Manager and variables can be connected in any required combination with the CANopen slave interface.

Default Configuration

In this configuration, the CANopen data are mapped as follows:

CANopen data

PDO number	Read/Write	BX process image
PDO 1	Rx/Tx	%IB1000...%IB1007/QB1000...%QB1007
PDO 2	Rx/Tx	%IB1008...%IB1015/QB1008...%QB1015
PDO 3	Rx/Tx	%IB1016...%IB1023/QB1016...%QB1023
PDO 4	Rx/Tx	%IB1024...%IB1031/QB1024...%QB1031

In the default configuration the Tx PDOs are only transferred in the event of a change.

More than 4 PDOs

Utilization of more than 4 PDOs can be specified in the TwinCAT configuration or in the default configuration. With the TwinCAT configuration the required PDOs are created in the System Manager file, and the configuration is transferred to the BX5100/BC5150. With the default configuration objects 0x14xx (for TxPDOs) and 0x18xx (for the RxPDOs) have to be used for this purpose before the node is started. The COB ID should be entered in subindex 1, and the data transfer type in subindex 2.

Example for PDO 5 of the node with address 11:

0x1804 subindex 1, length 4, value 0x68B

0x1804 subindex 2 length 1 value 0xFF (not necessarily required for activating the PDO)

0x1404 subindex 1 length 4 value 0x78B

0x1404 subindex 2 length 1 value 0xFF (not necessarily required for activating the PDO)

With the BX5100 a maximum of 32 PDOs can be used in each direction (32 TxPDOs and 32 RxPDOs). With the BC5150 a maximum of 16 PDOs can be used in each direction (16 TxPDOs and 16 RxPDOs).

PDO number	Read/Write	BX process image
PDO 5	Rx/Tx	%IB1032...%IB1039/QB1032...%QB1039
PDO 6	Rx/Tx	%IB1040...%IB1047/QB1040...%QB1047
PDO 7	Rx/Tx	%IB1048...%IB1055/QB1048...%QB1055
...	Rx/Tx	...
PDO 32	Rx/Tx	%IB1248...%IB1255/QB1248...%QB1255

Acyclic Synchronous

PDOs of transmission type 0 function synchronously, but not cyclically. An RxPDO is only evaluated after the next SYNC telegram has been received. In this way, for instance, axis groups can be given new target positions one after another, but these positions only become valid at the next SYNC - without the need to be constantly outputting reference points. A device whose TxPDO is configured for transmission type 0 acquires its input data when it receives the SYNC (synchronous process image) and then transmits it if the data correspond to an event (such as a change in input) having occurred. Transmission type 0 thus combines transmission for reasons that are event driven with a time for transmission (and, as far as possible, sampling) and processing given by the *reception of "SYNC"*.

Cyclic Synchronous

In transmission types 1-240 the PDO is sent cyclically after each nth SYNC (n=1...240). Since transmission types can be combined on a device as well as in the network, it is possible, for example, for a fast cycle to be agreed for digital inputs (n = 1), whereas the data for analog inputs is transmitted in a slower cycle (e.g. n = 10). RxPDOs generally do not differentiate between the transmission types 0...240: a received PDO is set to valid with the next SYNC reception. The cycle time (SYNC rate) can be monitored (object 0x1006), so that if the SYNC fails the device reacts in accordance with the definition in the device profile, and switches, for example, its outputs into the error state.

The CANopen CiFx0 PC cards always transmit under event control, even if the transmission type is set in the range from 1-240. This behavior is quite similar to transmission type 0. The FC510x PC cards support cyclic synchronous transmission types completely.

Asynchronous

The transmission types 254 and 255 are asynchronous, but may also be event-driven. In transmission type 254, the event is vendor-specific, whereas for type 255 it is defined in the device profile. In the simplest case, the event is the change of an input value - this means that every change in the value is transmitted.

Send delay time (inhibit time)

(BC5150 and BX5100 do not support this function.)

The *Inhibit Time* parameter can be used to implement a transmit filter that does not increase the reaction time for relatively new input alterations, but is active for changes that follow immediately afterwards. The send delay time describes the minimum time interval required between sending two identical telegrams. If the inhibit time is used, the maximum bus loading can be determined, so that the worst case latency can then be found.

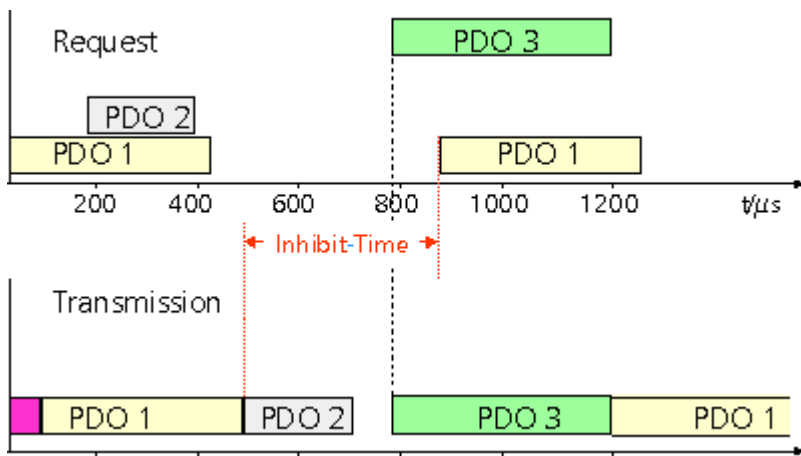

Fig. 43: Send delay time (inhibit time)

The transmitted PDOs become automatically spread out (transmit delay) as a result of the selected PLC cycle time - and there is little value in having the PLC run faster than the bus bandwidth permits. The bus loading, furthermore, can be significantly affected by the synchronous communication.

Event Timer

An event timer for transmit PDOs can be specified by subindex 5 in the communication parameters. Expiry of this timer is treated as an additional event for the corresponding PDO, so that the PDO will then be transmitted. If the application event occurs during a timer period, it will also be transmitted, and the timer is reset.

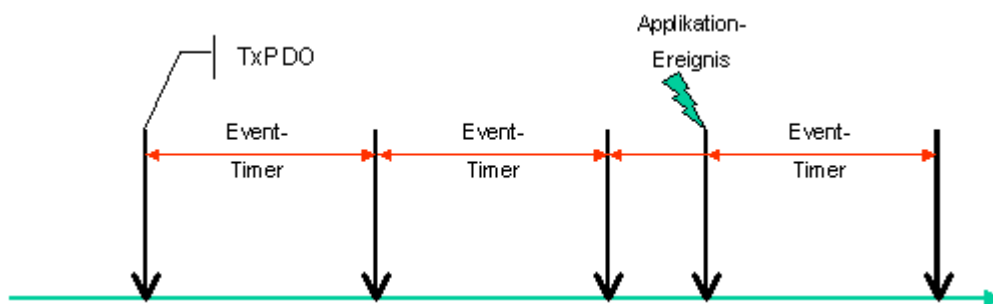

Fig. 44: Event timer

In receive PDOs the timer parameter is used to specify the monitoring time for the respective PDO: The application will be notified if no corresponding PDO was received within the set time.

4.2.7.2 TwinCAT configuration

The TwinCAT configuration enables free, address-independent mapping of the PLC data to the CAN slave interface.

TwinCAT configuration

The configuration requires the TwinCAT System Manager and an ADS connection to the Bus Terminal Controller.

The ADS connection can be realized via the serial interface (see serial ADS) or the fieldbus (FC510x PCI card and the CAN slave interface of the BX5100).

4.2.7.3 Slave address

Use the two rotary selection switches to set the slave address. The default setting is 11. All addresses from 0 to 63 are permitted. Each address may only occur once in the network. The address is edited when the BX Controller is switched off. The switches can be set to the required position using a screwdriver. Ensure that the switches engage correctly. The lower switch is the 10-multiplier, the upper switch is the 1-multiplier. The changed address is active as soon as the BX Controller is switched on again.

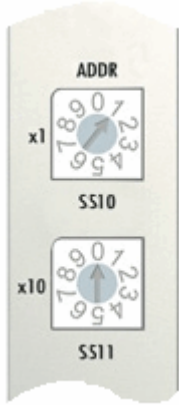

Fig. 45: Setting the node ID

Example

- You want to set address 34.
- lower rotary selection switch S311: 3
 - upper rotary selection switch S310: 4

4.2.7.4 Baud rate

Auto-Baud-Rate

In order for automatic baud rate detection to function, it is necessary for a number of valid telegrams to be present on the bus at the desired baud rate. The RUN and CAN ERR LEDs blink in rapid alternation while the baud rate search is in progress. Once a baud rate was detected and accepted, the Bus Terminal Controller continues with the initialization.

A software reset does not lead to a new baud rate search. The previously active baud rate is maintained.

Bit Timing

The following baud rates and entries in the bit-timing register are supported by the BECKHOFF CANopen devices:

Baud rate [kbaud]	BTR0	BTR1	Sampling Point
1000	0x00	0x14	75%
800	0x00	0x16	80%
500	0x00	0x1C	87%
250	0x01	0x1C	87%
125	0x03	0x1C	87%
100	0x04	0x1C	87%
50	0x09	0x1C	87%
20	0x18	0x1C	87%
10	0x31	0x1C	87%

The bit-timing register settings given (BTR0, BTR1) apply, e.g. for the Philips 82C200, SJA1000, Intel 80C527, Siemens 80C167 and other CAN controllers. They are optimized for the maximum bus length.

4.2.8 K-bus

i Bus Terminal and end terminal required

To operate a Bus Terminal Controller of the BC or BX series, at least one Bus Terminal with process image and the end terminal must be connected to the K-bus.

BX Settings tab

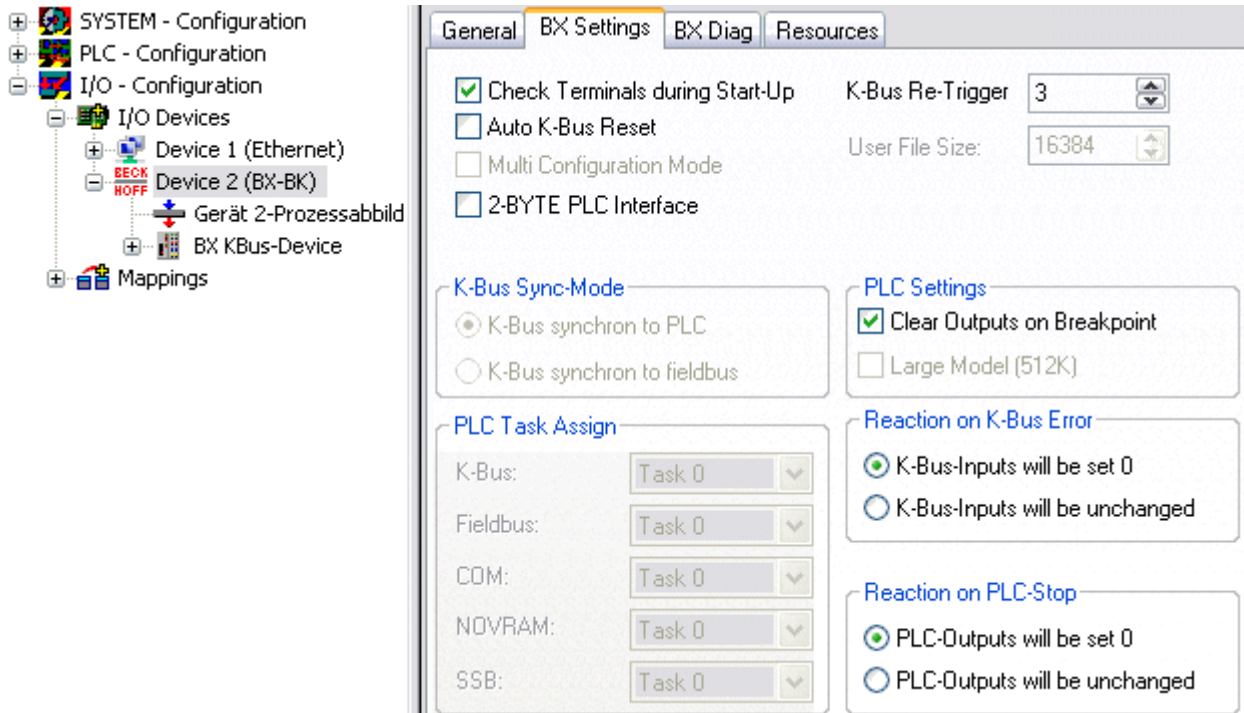

Fig. 46: BX Settings tab

Check Terminals during Start-up

When a boot project is created, the current Bus Terminal configuration is stored. The connected Bus Terminals are checked when the Bus Terminal Controller restarts. If this option is selected, the Bus Terminal Controller does not enter into data exchange. The PLC project will not be started.

Auto K-Bus Reset

Once a K-bus error has been rectified, the Bus Terminal Controller automatically resumes the data exchange.

⚠ CAUTION

Once a K-Bus error has been rectified, the outputs become active again immediately!

Ensure that the outputs are reactivated immediately and that analog outputs retain their programmed value, if this is not dealt with in your PLC project.

Clear Outputs on Breakpoint

If breakpoints are set in PLC Control, the K-Bus is no longer processed, i.e. the outputs are set to a safe state (zero).

K-Bus Sync Mode

Writing and reading of the Bus Terminals can take place synchronously with task 1 or the fieldbus.

K-Bus Re-Trigger

If the processor is busy dealing with the PLC project or the SSB, the K-Bus cannot be processed for a certain amount of time. This leads to triggering of the Bus Terminal watchdog and dropping of the outputs. The Bus Terminal Controller is set such that the K-bus watchdog is re-triggered 3 times after 85 ms. The K-Bus watchdog would then be activated.

K-Bus Re-Trigger 0: 100 ms

K-Bus Re-Trigger 1: 2 x 85 ms = 170 ms

K-Bus Re-Trigger 2: 3 x 85 ms = 255 ms

K-Bus Re-Trigger 3: 4 x 85 ms = 340 ms

Reaction on K-Bus Error

In the event of a K-Bus error, the K-Bus inputs are set to "0" or retain their last state.

Response on PLC-Stop

The user can set the behavior of the fieldbus output data in the event of the PLC project being stopped. The master will use these data as input data. In the event of a PLC stop, the data can be set to "0" or remain unchanged.

BX Diag tab

Display of the cycle time for task 1, K-bus, fieldbus processing and the SSB load.

	Actual Value	Maximum Value
PLC-Task 1 (µs):	72	144
PLC-Task 2 (µs):		
PLC-Task 3 (µs):		
PLC-Task 4 (µs):		
K-Bus (µs):	246	303
Fieldbus (µs):	21	31
SSB (µs):		
SSB-Overhead (%):		

Buttons: Read CurrentConfig.xml..., Reset Maximum Values, Factory Settings

Display 1: TWINCAT-CONFIG
Display 2: BC9020PROJEKT

Fig. 47: BX Diag tab

Factory Settings: the Bus Terminal Controller is set to its delivery. These settings are reactivated via Restart System or by switching the system off and on again (display shows DEFAULT-CONFIG).

Reset Maximum Values: resets the maximum values

K-Bus variables

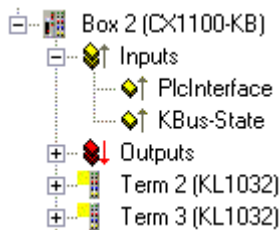

PLC interface: Not supported (only included for moving CX or BX projects)

K-bus state: see Diagnostics

4.2.9 PLC

4.2.9.1 Inserting a PLC project

For variable mapping, configuration has to be specified in the system manager. This is where the link between PLC and hardware is specified. The variables can process and link bit, byte, word or data structures. Automatic addressing via the System Manager is possible, but should be checked for offset.

i Word alignment, byte orientation

With data structures, ensure that the Bus Terminal Controller saves the data in word alignment and the System Manager operates byte-oriented (see [Data structures \[► 91\]](#))

A valid project has to be compiled and saved in PLC Control. These data are saved as a *.tpy file. For inserting a PLC project, right-click on *PLC - Configuration*. Select your current PLC project.

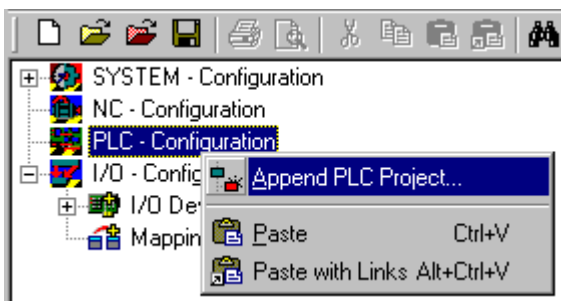

Fig. 48: Selecting the PLC project

Link the PLC variable with the hardware (e.g. digital Bus Terminal).

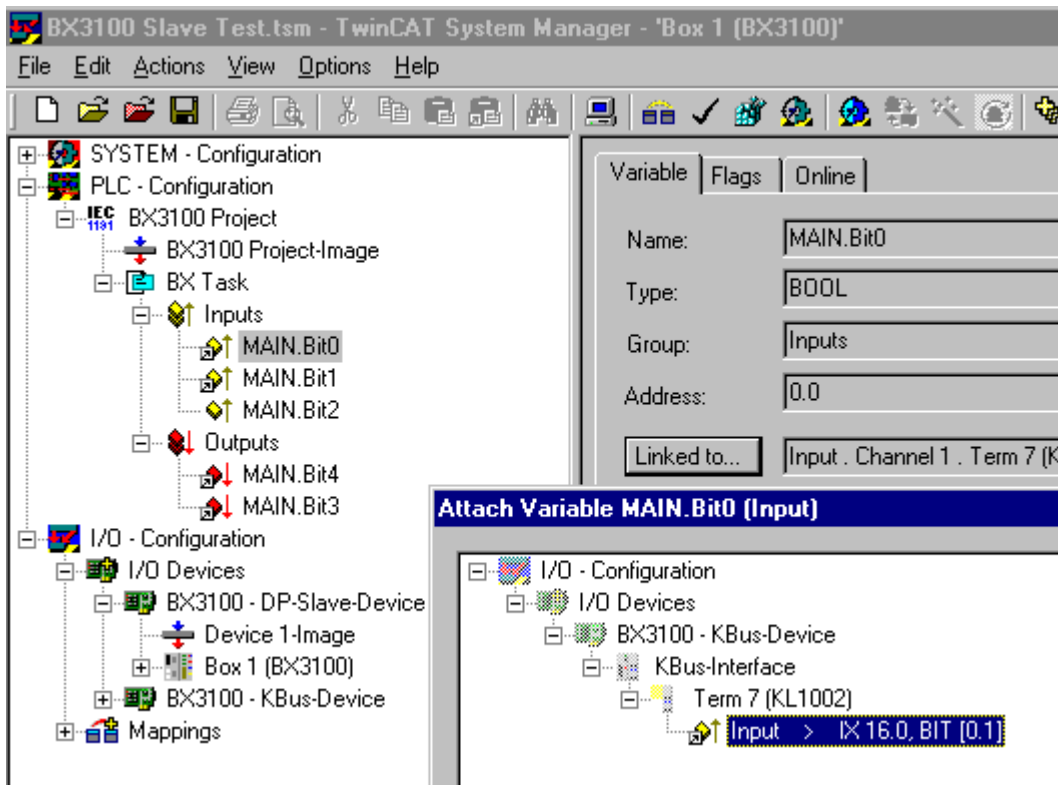

Fig. 49: Connecting PLC variable and hardware

Once all links have been created, activate the configuration *Actions/Activate Configuration (Ctrl+Shift+F4)* and start TwinCAT *Set/Reset TwinCAT to Run Mode*. Ensure that you have selected the correct target system (bottom right in the System Manager window).

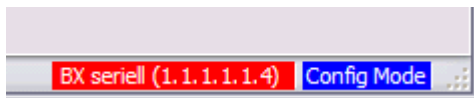

Fig. 50: Target system display

4.2.9.2 Measuring the PLC cycle time

The task time is set in PLC Control. The default setting is 20 ms.

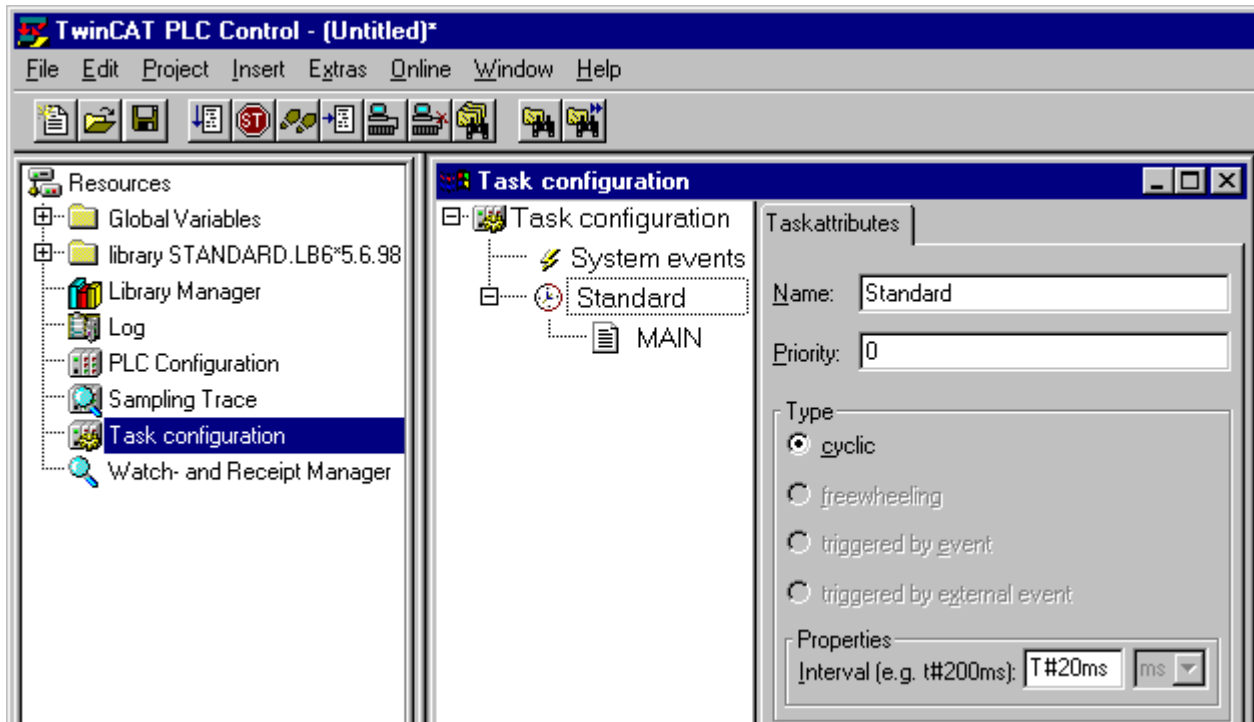

Fig. 51: Setting the task time

In the default setting, the PLC program is called every 20 ms, as long as the general cycle time is less than 20 ms. To determine the load of your system, the PLC cycle time can be measured in the System Manager. In order to ensure trouble-free operation, the set task time should be 20-30 % higher than the measured total cycle time. A precise cycle time breakdown can be found under [K-Bus tab \[► 48\]](#) description. The total cycle time is displayed with the TcBase library (see TcBase.lbx or TcBaseBCxx50.lbx).

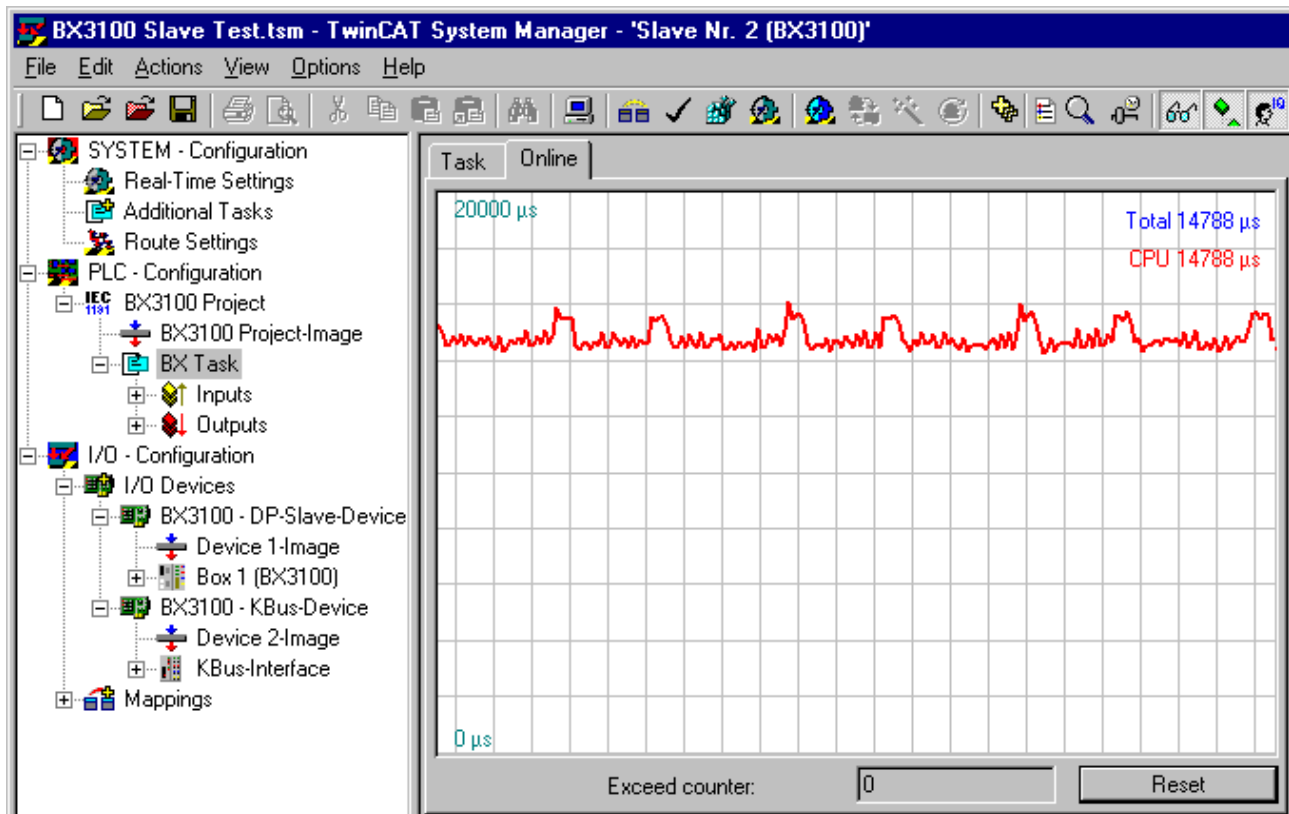

Fig. 52: Displaying the PLC cycle time

4.2.10 SSB

4.2.10.1 SSB overview

The SSB (Smart System Bus) is a sub-bus system based on CANopen. It is a CANopen master with limited functionality. CANopen slaves may be connected to this interface for reading or writing distributed I/Os. Parameterization SDOs (service data objects) can be sent to the slave via a start-up window.

Configuration

The SSB is configured via the TwinCAT System Manager (see TwinCAT config). The configuration is then loaded onto the BX controller via ADS.

Technical data

SSB	Data
Max. number of slaves	8
Max. number of PDOs	32 RxPDOs / 32 TxPDOs
Baud rate	10 kbaud to 1 Mbaud
Permitted slave addresses	1 to 64

Sync telegram

The sync telegram is transferred depending on the PLC task time. If a task time of 20 ms is set, the sync telegram is also sent every 20 ms (asynchronous with the PLC run time). The sync telegram is only generated when a device requires it and is configured accordingly. Sync telegrams are supported from firmware 1.12.

Guarding

Guarding is supported and is sent after a configurable interval.

4.2.10.2 SSB configuration

The SSB is configured in the system manager. Open your existing configuration, in which you have already configured the PLC project, the K-bus and the higher-level fieldbus, or open a new configuration. Under I/O devices (left mouse button) a further device can now be appended.

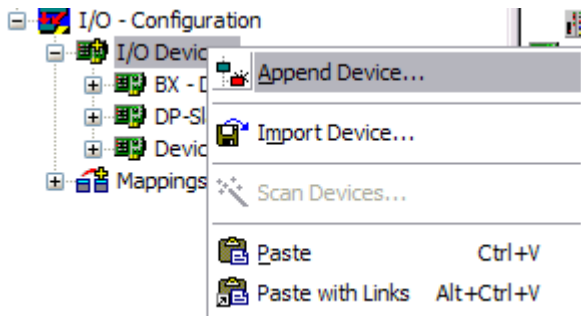

Fig. 53: Adding a further device

Select the CANopen Master SSB and confirm with OK.

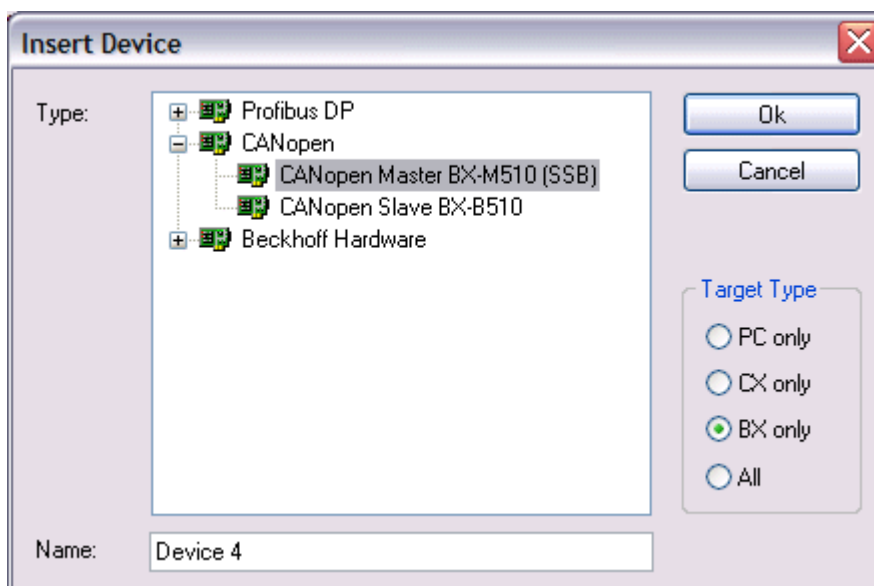

Fig. 54: Selecting the CANopen master SSB

With the left mouse button, a CANopen node can now be selected on the SSB device.

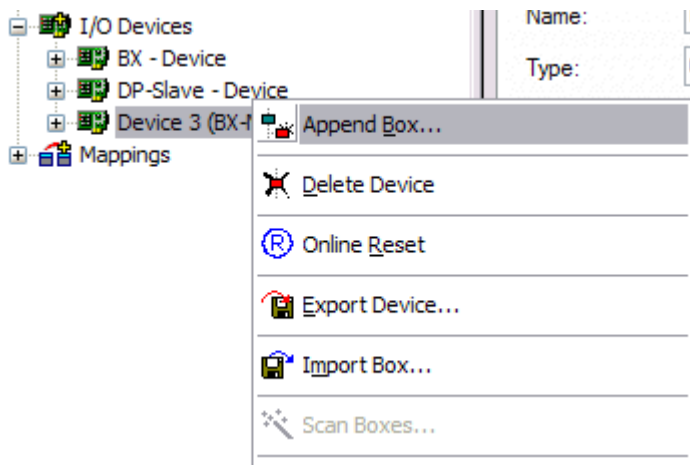

Fig. 55: Adding a CANopen device

All Beckhoff CAN nodes are available, as well as a general CANopen node for CANopen devices from other manufacturers.

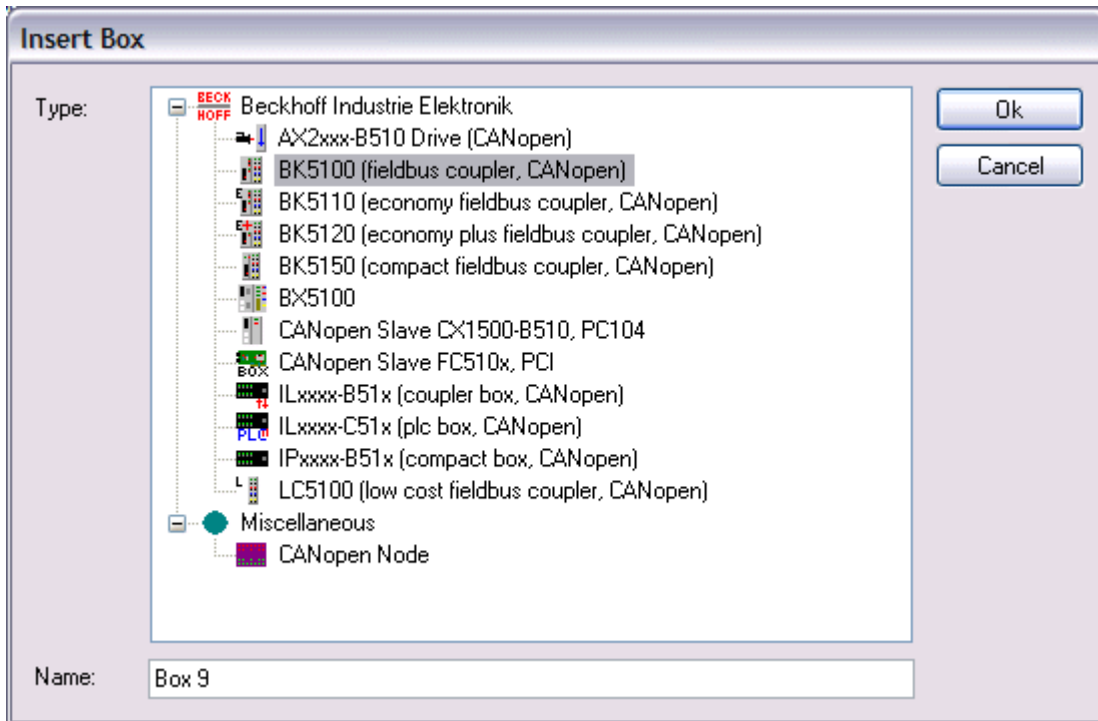

Fig. 56: Selecting a CANopen node

Now link the PLC variables with your CAN node. Once the configuration is complete, load it into the BX.

4.2.10.3 SSB - SDO communication

CANopen SDO communication (Service Data Object) is used to read or write any parameters in the CANopen bus node's object directory. The SSB uses the SDO communication for configuring the communication parameters during start-up.

Downloading Application-Specific Parameters when Starting Up

The appropriate parameters are to be entered here in the System Manager for the corresponding node in tab "SDO". The objects that result from the configuration under CAN node appear in square brackets. Any desired number of object directory entries can then be inserted.

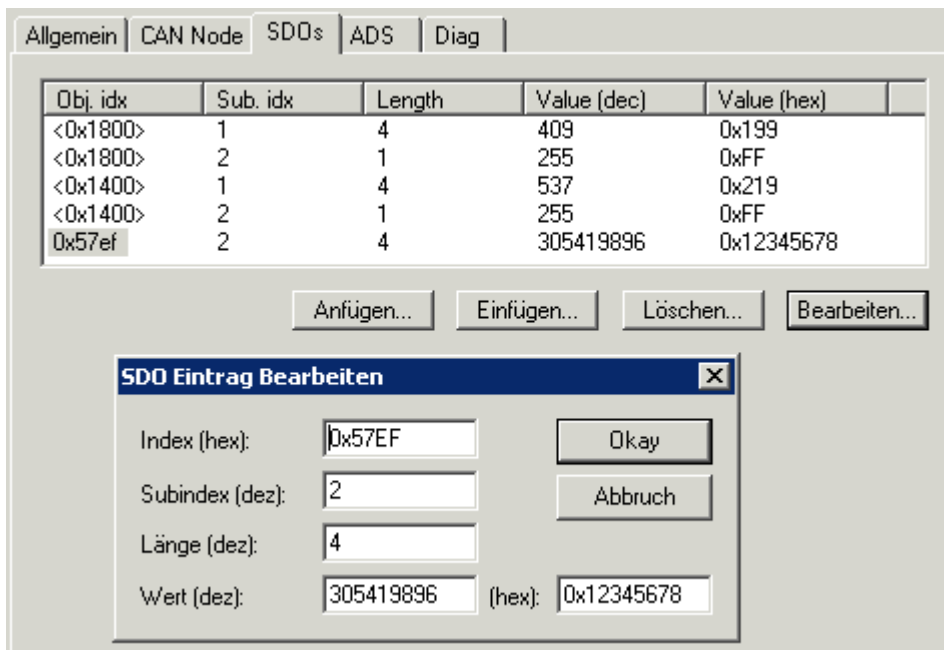

Fig. 57: Adding/editing object directory entries

The SSB expects a positive acknowledgement of the parameter download from the respective bus device. If it was not possible to write a parameter (the bus device has aborted the SDO) the card then attempts to read the corresponding value back and to compare it with the value that was to be written. This is because it could, for instance, be a read-only value, and therefore already correctly configured within the bus device. If they agree with one another, the card moves onto the next parameter entry.

4.2.10.4 SDO communication from the PLC

ADS blocks are used for SDO communication from the PLC. These blocks can be used for sending SDO telegrams and receiving the response of the slave (ADSWRITE/ADSREAD).

Input parameters	Description
NETID	Local NetId of the BX or leave empty, e.g. with "
Port number	0x1000 _{hex} + NodeId (slave number)
IDXGRP	SDO Index
IDXOFFS	SDO Subindex
LEN	Length of SDO data (1...4)

 Download BX (<https://infosys.beckhoff.com/content/1033/bx5100/Resources/prx/3207257611.prx>)

Setting individual or all nodes to pre-operational or operational state

The ADSWRTCTL function block can be used for setting individual CANopen nodes or all slaves to pre-operational or operational state.

Input parameters	Description
NETID	Local NetId of the BX or leave empty, e.g. with "
Port number	0x1000 _{hex} + NodeId (slave number) / 153 _{dec} (all nodes)
ADSSTATE	ADSSTATE_RUN
DEVSTATE	1 - Pre / 0 - Operational
LEN	0
SRCADDR	0

 Download BX (<https://infosys.beckhoff.com/content/1033/bx5100/Resources/prx/3207259787.prx>)

Restarting the SSB interface

The ADSWRTCTL function block can be used to stop and restart the SSB. It should be stopped first before restarting it.

Input parameters	Description
NETID	Local NetId of the BX or leave empty, e.g. with "
Port number	153 _{dec}
ADSSTATE	ADSSTATE_STOP, ADSSTATE_RUN
DEVSTATE	0
LEN	0
SRCADDR	0

or

Input parameters	Description (from software version 1.16 for all BX controllers)
NETID	Local NetId of the BX or leave empty, e.g. with "
Port number	300 _{dec}
ADSSTATE	ADSSTATE_RESET
DEVSTATE	0
LEN	4
SRCADDR	ADR on a DWORD variable with the ID of the SSB device (the ID can be obtained from the System Manager file and is typically a value between 1 and 3).

4.2.10.5 Emergency telegrams and diagnostics

The status of the CAN slave is indicated by NodeState. The DiagFlag is set if an emergency telegram was received. The EmergencyCounter is incremented with each emergency telegram.

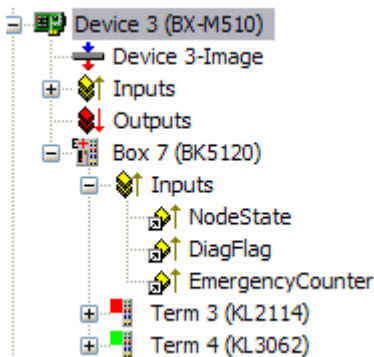

Fig. 58: NodeState, DiagFlag and EmergencyCounter

NodeState value	Description
0	No error
1	Node deactivated
2	Node not found
4	SDO syntax error at Start Up
5	SDO data mismatch at Start Up
8	Node start up in progress
11	SSB Bus off
12	Pre-Operational
13	Severe bus fault
14	Guarding: toggle error
20	TxPDO too short
22	Expected TxPDO is missing
23	Node is Operational but not all TxPDOs were received

ADS Port 153

Reading of emergency telegrams with AdsRead

Input parameters	Description
NETID	local NetId of BX
Port number	153
IDXGRP	16#xxxxF180 (xxxx) NodeId, the Diag flag is only reset when at least 106 bytes are read 16#xxxxF181 (xxxx) NodeId, the Diag flag is reset immediately
IDXOFFS	Byte Offset

Description of the array

Offset	Bit	Value / description
0 - 1	Bit 0	reserved
	Bit 1	Boot up message not received or incorrect
	Bit 2	Emergency-Overflow
	Bit 3 - 15	reserved
2 - 3	Bit 0 - 14	TX-PDO (i+1) received
	Bit 15	All TX PDOs 16-n received
4 - 5	Bit 0 - 4	1: Incorrect TX PDO length
		2: Synchronous TX PDO absent
		3: Node signaling PRE-OPERATIONAL
		4: Event timer timed out for TX PDO
		5: No response and guarding is activated
		6: Toggling missed several times and guarding activated
	Bit 5 - 15	Associated COB ID
6	Bit 0 - 7	1: Incorrect value during SDO upload
		2: Incorrect length during SDO upload
		3: Abort during SDO up/download
		4: Incorrect date during a boot-up message
		5: Timeout while waiting for a boot-up message
7	Bit 0 - 7	2: Incorrect SDO command specifier
		3: SDO toggle bit has not changed
		4: SDO length too great
		5: SDO-Abort
		6: SDO-Timeout
8 - 9	Bit 0 - 7	SDO up/download index
10	Bit 0 - 7	SDO up/download subindex
11	Bit 0 - 7	reserved
12	Bit 0 - 7	errorClass des Aborts
13	Bit 0 - 7	errorCode des Aborts
14 - 15	Bit 0 - 15	Abort additionalCode
16 - 19		Read value (if offset 6 = 1)
20 - 23		Expected value (if offset 6 = 1)
24 - 25		Number of consecutive emergencies
26 - n		Emergencies (8 bytes each)

 Download BX (<https://infosys.beckhoff.com/content/1033/bx5100/Resources/prx/3207261963.prx>)

 Download sample System Manager file BX (<https://infosys.beckhoff.com/content/1033/bx5100/Resources/tsm/3207264139.tsm>)

Reading the number of PDO telegrams with AdsRead

Input parameters	Description
NETID	local NetId of BX
Port number	153
IDXGRP	16#xxxxF930 (xxxx) NodeId
IDXOFFS	0

 Download BX (<https://infosys.beckhoff.com/content/1033/bx5100/Resources/prx/3207266315.prx>)

i Configuration of the node ID required

The node ID must be configured before the ADS function blocks is called in the TwinCAT configuration.

Sending a CAN message

This ADSWRITE command enables any CAN message to be sent.

Input parameters	Description
NETID	local NetId of BX
Port Nummer	153
IDXGRP	16#0000F921
IDXOFFS	0
LEN	11 bytes
SRCADDR	Pointer to an 11 byte ARRAY

Structure of the 11 byte CAN data

Byte	Description	Example Node 7 SDO 0x607 Len 8 Download Request 0x2100 (Index) Sub Index 1 - Value "1"
1	COB-ID LowByte	0x06 (SDO Low Byte)
2	COB-ID HighByte	0x07 (SDO High Byte)
3	LEN (length)	0x08 (LEN, may be 5 in this case)
4	Data[1]	0x22 (Download Request)
5	Data[2]	0x00 (Index Low Byte)
6	Data[3]	0x21 (Index High Byte)
7	Data[4]	0x01 (Sub Index)
8	Data[5]	0x01 (Value "1")
9	Data[6]	0x00
10	Data[7]	0x00
11	Data[8]	0x00

4.2.10.6 Examples

4.2.10.6.1 BK5120 at SSB

Required material:

- TwinCAT 2.9 build 953 or higher
- BX3100 version 0.80 or higher, BX5100 version 0.13, BX8000 version 0.04
- 1 x KL1xx4
- 1 x KL2xx4
- 1 x KL9010
- 1 x BK5120
- 1 x KL1xx4
- 1 x KL2xx4
- 1 x KL9010
- Cabling material and power supply
- TwinCAT System Manager file (<https://infosys.beckhoff.com/content/1033/bx5100/Resources/tsm/3207268491.tsm>)

 (The system manager file has to be transferred to the BX controller via ADS).

- BX program file (<https://infosys.beckhoff.com/content/1033/bx5100/Resources/prx/3207270667.prx>)



For the configuration download via ADS, either a BECKHOFF fieldbus master or a free serial port is required.

4.2.10.6.2 Communication between BX controllers (via SSB)

2 or more BX controllers can exchange data via the SSB. Use 2 telegrams for configuring this data exchange in the System Manager (CAN layer).

CAN telegram communication is specified via the COB ID. The BX type is irrelevant, since the SSB is present on each BX controller, and the behavior and configuration is identical.



Fig. 59: Communication between BX controllers (via SSB)

Example configuration

```
BX_ONE:
Node Id 2
CAN_Out AT %QB100: ARRAY[0..7] OF BYTE
COD Id 514 0x202
CAN_In AT %IB100: ARRAY[0..7] OF BYTE
COD Id 386 0x182
```

```
BX_TWO:
Node Id 2
CAN_Out AT %QB100: ARRAY[0..7] OF
BYTE
COD Id 386 0x182
CAN_In AT %IB100: ARRAY[0..7] OF BYTE
COD Id 514 0x202
```

Configuration and program example:

Required material

- TwinCAT 2.9 build 959 or higher
- 2 x BXxx00
- Cabling material and power supply
- TwinCAT System Manager file BX_ONE (<https://infosys.beckhoff.com/content/1033/bx5100/Resources/tsm/3207272843.tsm>)



- Program file BX_ONE (<https://infosys.beckhoff.com/content/1033/bx5100/Resources/prx/3207275019.prx>)



- TwinCAT System Manager file BX_TWO (<https://infosys.beckhoff.com/content/1033/bx5100/Resources/tsm/3207277195.tsm>)



- Program file BX_ONE (<https://infosys.beckhoff.com/content/1033/bx5100/Resources/prx/3207279371.prx>)



For the configuration download via ADS, either a BECKHOFF master (FC310x, FC510x, FC520x) or a free serial port is required.

4.2.10.6.3 AX2000 at SSB



Fig. 60: AX2000

Required material:

- TwinCAT 2.9 build 953 or higher
- BX3100 version 0.80 or higher
- 1 x KL1xx4
- 1 x KL2xx4
- 1 x KL9010
- 1 x AX2000 with the following settings: Slave address 4, baud rate 500 kbyte
- Cabling material and power supply
- Example program and configuration on the BX Controller

- TwinCAT System Manager file (<https://infosys.beckhoff.com/content/1033/bx5100/Resources/tsm/3207281547.tsm>)



(The System Manager file has to be transferred to the BX Controller via ADS).

- BX program file (<https://infosys.beckhoff.com/content/1033/bx5100/Resources/prx/3207283723.prx>)



For the configuration download via ADS, either a BECKHOFF fieldbus master or a free serial port is required.

AX2000 description

The following sections are extracts from the AX2000 drive manual. Further information can be found on the internet at <http://www.beckhoff.de>.

Hardware and interfaces

Setting the Station Address

The station address (device address at the CAN bus) of the servo drive can be set in three ways:

- Via the front panel keyboard (see AX2000 installation guide)
- Via the "Basic settings" screen of the DRIVE.EXE commissioning software
- Via the serial interface with the following ASCII command sequence:

ADDR nn > SAVE > COLDSTART (with nn = address)

The address range can be extended from 1..63 to 1..127 with the ASCII object MDRV.

Setting the baud rate

The CAN transfer speed (baud rate) can be set in three ways:

- Via the front panel keyboard (see AX2000 installation guide)
- Via the "Basic settings" screen of the DRIVE.EXE commissioning software
- Via the serial interface with the following ASCII command sequence:
CBAUD bb > SAVE > COLDSTART (with bb = baud rate in kB)

Possible baud rates are 10, 20, 50, 100, 125, 250, 333, 500 (default), 666, 800 or 1000 kBaud.

CANopen Interface (X6)

Interface for connection to the CAN bus (default 500 kBaud). The integrated profile is based on the DS301 CANopen communication profile and on the DSP402 drive profile. The following functions are available in combination with the position controller:

jogging with variable speed, reference motion, start travel command, start direct travel command, digital set value specification, data transfer functions and many others.

Detailed information can be found in the CANopen manual. The interface is electrically isolated via an optocoupler and has the same potential as the RS232 interface. The analog set value inputs can still be used. The two interfaces (RS232 and CAN) occupying the same connector (X6) can be split to two connectors via the optional 2 CAN extension card.

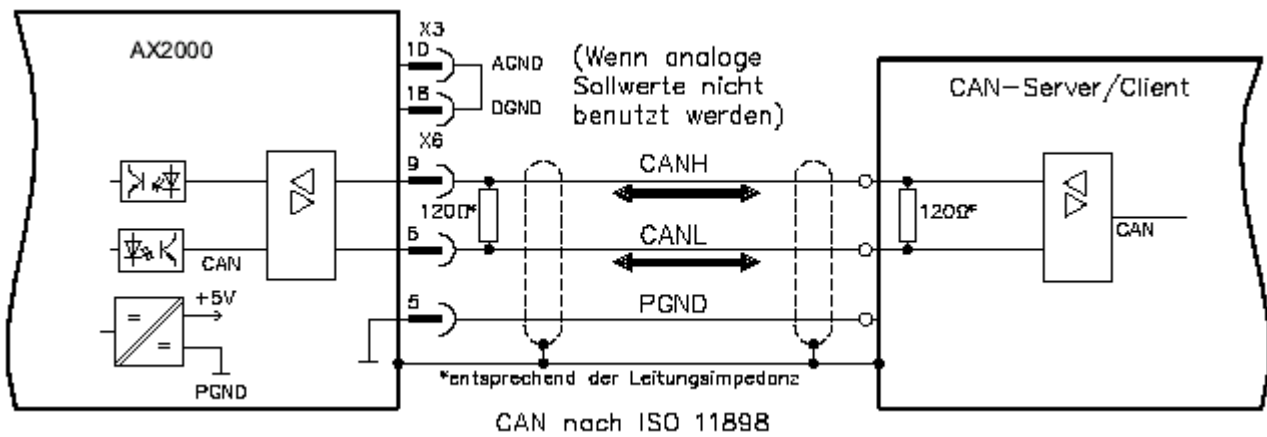

Fig. 61: CANopen Interface (X6)

4.2.10.6.4 Cimrex panel at the SSB of the BX controller

The CAN interface of the BX controller can also be used for connecting an operating panel. In this example, a panel from the company Beijers is connected. Further information on the panel can be found under <http://www.beijerelectronics.de>.



Fig. 62: Cimrex panel at the SSB of the BX controller

Necessary components

- 1 x BX3100
- Some Bus Terminals for the K-bus (here 3 x KL2114, can be adjusted in the System Manager file)
- 1 x Cimrex 41
- 1 x CAB 15 CAN adapter
- BX sample program in ST: (<https://infosys.beckhoff.com/content/1033/bx5100/Resources/prx/3207285899.prx>)



- BX example configuration: (<https://infosys.beckhoff.com/content/1033/bx5100/Resources/tsm/3207288075.tsm>)



- Example for Cimrex 41: (<https://infosys.beckhoff.com/content/1033/bx5100/Resources/cpa/3207290251.cpa>)



- Baud rate 500 kbaud
- CAN slave address 10

4.2.10.6.5 IclA drive at SSB



IclA[®]

Fig. 63: IclA drive at SSB

Required material:

- TwinCAT 2.9 build 953 or higher
- BX3100 version 0.80 or higher
- 1 x KL1xx4
- 1 x KL2xx4
- 1 x KL9010
- 1 x IclA D065 with the following settings: slave address 10, baud rate 500 kbyte (Please note: These are not the default parameters of the drive)
- Cabling material and power supply

For the configuration download via ADS, either a BECKHOFF fieldbus master or a free serial port is required.

Reconfiguration example for TwinCAT with FC510x CANopen master card

An example for converting a drive is listed below.

- TwinCAT System Manager file (<https://infosys.beckhoff.com/content/1033/bx5100/Resources/wsm/3207292427.wsm>)



- TwinCAT PLC file (<https://infosys.beckhoff.com/content/1033/bx5100/Resources/pro/3207294603.pro>)



Example program and configuration on the BX Controller

- TwinCAT System Manager file (<https://infosys.beckhoff.com/content/1033/bx5100/Resources/tsm/3207296779.tsm>)



(The System Manager file has to be transferred to the BX Controller via ADS).

- BX program file (<https://infosys.beckhoff.com/content/1033/bx5100/Resources/prx/3207298955.prx>)



IclA D065 description

The following sections are extracts from the IclA drive manual. They were provided by the company SIG Positec Automation GmbH for the purpose of describing the basic parameters. Further information can be found on the internet at <http://www.sig-positec.de>.

Hardware and interfaces

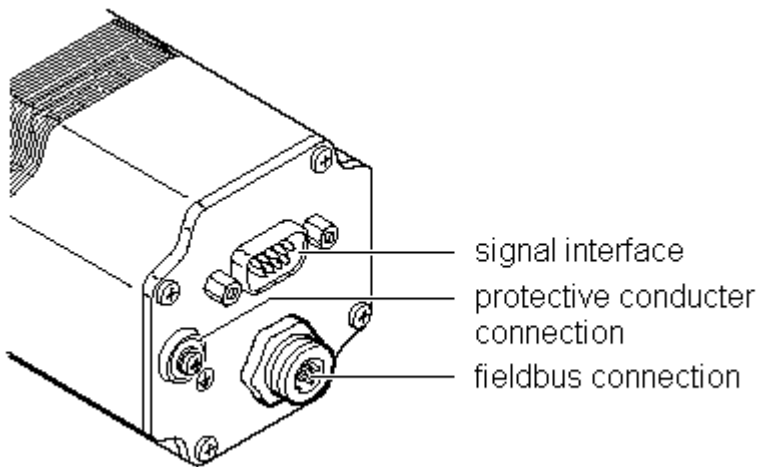

Fig. 64: IclA drive connections

- Signal interface for
 - Supply voltage
 - Control signals for manual mode
 - Connection for emergency stop signal
- Protective conductor connection for earthing via PE bus bar
- Fieldbus connection for connecting the fieldbus cable.

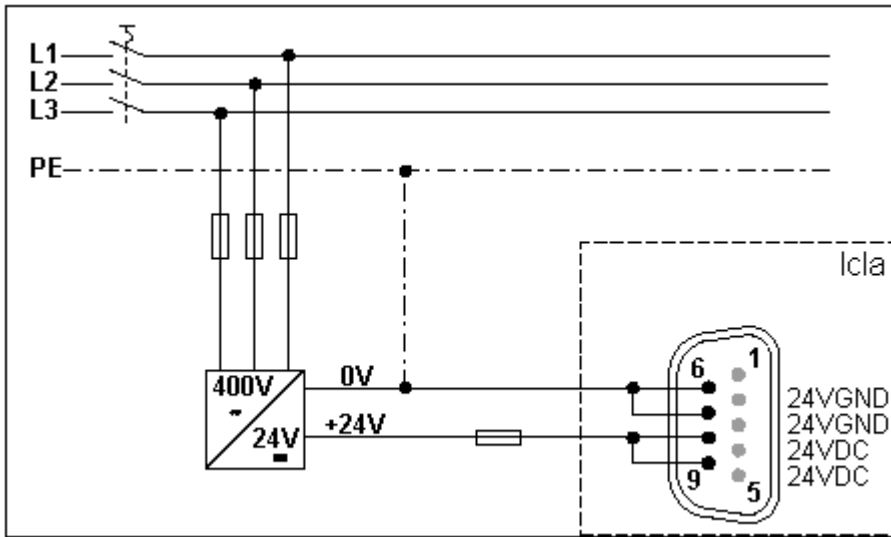

Fig. 65: Signal interface

If the emergency stop function is not required, connect pin 2 with pin 8 or 9 (24 V_{DC}).

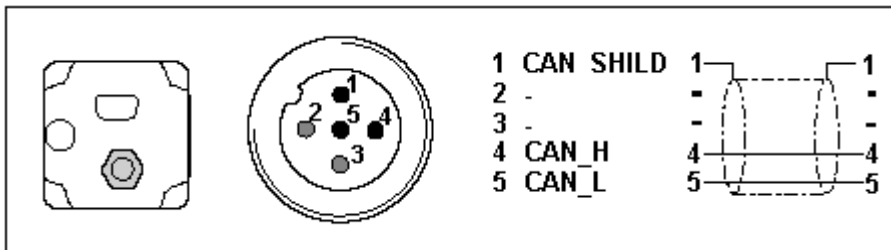

Fig. 66: Fieldbus connection

Control word 0x6040

The object represents the control word for the device. The control word is used for several control tasks:

- Changeover between different operating states. The possible states and transitions can be found under the index keyword "machine state". Bits 0 to 3 and bit 7 are relevant for a change of state.
- Starting and stopping mode-specific functions, e.g. starting a travel command via bit 4. Bits 4 to 6 are used for mode-specific settings. Further details can be found under the keywords "Operating mode, starting", "Operating mode, monitoring" and in the description of the respective operating modes in sections "Manual mode" and "Positioning mode".
- Stopping of the positioning drive from an active travel operation. Bit 8 "Stop" is used for stopping. Further details can be found under the keywords "Operating mode, starting" and "Operating mode, monitoring".

Object description	Value description
Index	6040h
Object name	Control word
Data type	Integned16
Subindex	00h, control word
Access	read-write
PDO-Mapping	R_PDO

Bit	Name	Meaning
11..15	Manufacturer specific	not used
9, 10	-	reserved
8	Stop	Stop motor
7	Reset fault	Reset fault
4..6	-	Operating mode dependent,
3	Enable operation	Execute operating mode
2	Quick stop (low active)	Breaking with quick stop ramp
1	Disable voltage (low active)	Switch off voltage
0	Switch on	Switch into ready-to-run state

Status word 0x6041

The object describes the current operating state of the device. The status word can be used for the following monitoring functions:

- Checking the operating state of the positioning controller. Bits 0 to 3, 5 and 6 are relevant.
- Bit 4 indicates whether the output stage is ready for processing a transport instruction.
- Bits 7 to 15 are used for monitoring the travel operation and for status monitoring of device-specific states.

Further details for monitoring travel operation can be found under the keywords "Operating mode, starting", "Operating mode, monitoring" and in the description of the respective operating modes in sections "Manual mode" and "Positioning mode". The bits for device status monitoring are described in section "Diagnostics and trouble shooting".

The control word is represented in the first two bytes of the R_PDOs.

Object description	Value description
Index	6041h
Object name	Status word
Data type	Unsigned16
Subindex	00h, status word
Access	read-only
PDO Mapping	T_PDO

Bit	Name	Meaning
15	Out of security area	Out of security area 0->1: Limit switch position S0 or S1 exceeded
14	Out of drive area	Out of drive area 0->1: Limit switch position D0 or D1 exceeded
12..13	-	Operating mode-dependent meaning
11	Internal limit active	Out of working area
10	Target reached	Target reached 1->0: New target position transferred 0->1: Requested target position reached or motor standstill after stop request
9	Remote	0: manual mode 1: no manual mode
8	Right out of drive area	Only valid if bit 11 = 1 - 0: Limit switch position W1 exceeded - 1: Limit switch position W0 exceeded
7	Warning	Warning
6	Switch on disabled	not ready for operation
5	Quick Stop	Quick stop active
4	Voltage disabled	Voltage off
3	Fault	Fault occurred
2	Operation enabled	Operating mode enabled
1	Switched on	Ready for operation
0	Ready to switch on	Ready to switch on

Reference ranges

A valid referencing is defined via three limit switch zones, which have to be within the possible traversing range of the drive. The limit switches protect the drive and the system from damage.

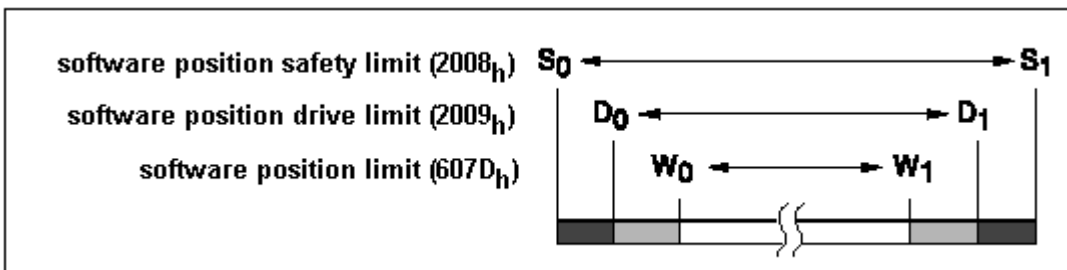

Fig. 67: Reference ranges

- Working area W0 - W1 for positioning mode.
- Drive area D0 - D1. From ranges D0 - W0 and D1 - W1, the drive can only be moved backwards towards the operating range.
- Security area S0 - S1. From areas S0 - D0 and S1 - D1, the drive can only be moved backwards manually.
- CANopen objects - three CANopen objects are used for setting up the limit switches. They contain the position values for the upper and lower range limits.
- Working area limits in software position limit (607D_{hex})
- Drive area limits in software position drive limit (2009_{hex})
- Security area limits in software position safety limit (2008_{hex})

Referencing example

The following listing demonstrates the input of the referencing values. The node address of the positioning drive is set to 01_{hex}.

COB-ID		Data	Meaning
601	2F	60 60 00 06	R_SDO: switch to homing mode
581	60	60 60 00 xx	T_SDO: OK
601	23	08 20 02 0C 7B 00 00	R_SDO: max. value safety range S ₁ : 7B0Ch
581	60	08 20 02 xx xx xx xx	T_SDO: OK
601	23	08 20 01 00 00 00 00	R_SDO: min. value safety range S ₀ : 0000h
581	60	08 20 01 xx xx xx xx	T_SDO: OK
601	23	09 20 02 42 72 00 00	R_SDO: max. value driving range D ₁ : 7242h
581	60	09 20 02 xx xx xx xx	T_SDO: OK
601	23	09 20 01 CA 08 00 00	R_SDO: min. value driving range D ₀ : 8CAh
581	60	09 20 01 xx xx xx xx	T_SDO: OK
601	23	7D 60 02 AE 60 00 00	R_SDO: max. value working range W ₁ : 60AEh
581	60	7D 60 02 xx xx xx xx	T_SDO: OK
601	23	7D 60 01 5E 1A 00 00	R_SDO: min. value working range W ₀ : 1A5Eh
581	60	7D 60 01 xx xx xx xx	T_SDO: OK
601	23	10 10 03 73 61 76 65	R_SDO: save application parameter: "save"
581	60	10 10 03 xx xx xx xx	T_SDO: OK
601	2F	98 60 00 FF	R_SDO: setting the reference type
581	60	98 60 00 xx	T_SDO: OK
601	23	0B 20 00 BC 34 00 00	R_SDO: dimension setting, current position to S ₀ : 34BCh
581	60	0B 20 00 xx xx xx xx	T_SDO: OK
601	2B	40 60 00 1F 00	R_SDO: homing operation start (rising edge, bit 4)
581	60	40 60 00 xx xx	T_SDO: OK

Fig. 68: Listing of the referencing values

4.2.10.6.6 Lenze frequency converter at SSB

Lenze



Fig. 69: Frequency converter from Lenze

Required material

- TwinCAT 2.9 build 953 or higher
- BXxx00
- 1 x KL1xx4
- 1 x KL2xx4
- 1 x KL9010
- 1 x Lenze 8200 vector + motor
- 1 x Lenze CANopen Interface 2175
- Cabling material and power supply

For the configuration download via ADS you need a BECKHOFF fieldbus master card or a free serial port.

Lenze description

The following sections are extracts from the Lenze 2175 manual. They were provided by the company Lenze Drive Systems GmbH for the purpose of describing the basic parameters. Further information can be found on the internet at <http://www.Lenze.com>.

Initial commissioning

Set the power supply for the bus module to internal power supply.

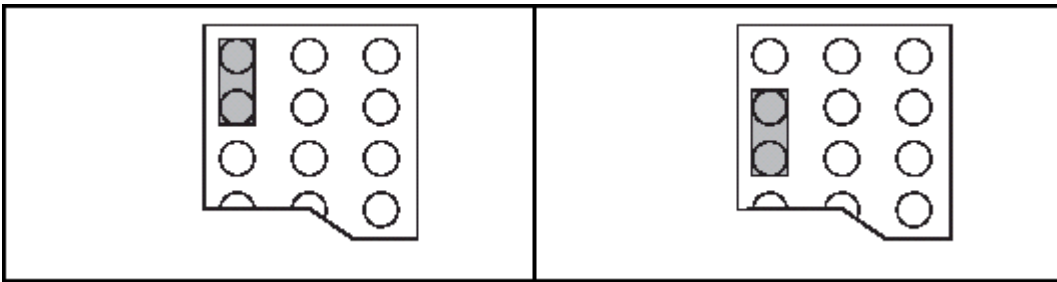

Fig. 70: External power supply - internal power supply (State at Delivery)

For CANopen communication set DIP switch 10 to "ON".

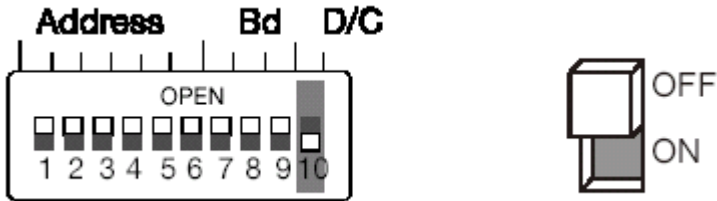

Fig. 71: DIP switch

Baud rate DIP switches 7-9

Transfer rate [kbps]	S7	S8	S9
10	ON	ON	OFF
20	ON	OFF	ON
50	OFF	ON	ON
125	OFF	ON	OFF
250	OFF	OFF	ON
500 (default)	OFF	OFF	OFF
1000	ON	OFF	OFF

i **Priority of the DIP switches**
 DIP switch 6 has the smallest weighting.
 Example: Address 3 switches 5 and 6 "ON".

Enabling the communication module

Switch to operating mode 3 for enabling the communication module. This can be achieved via the SSB using the following entry:

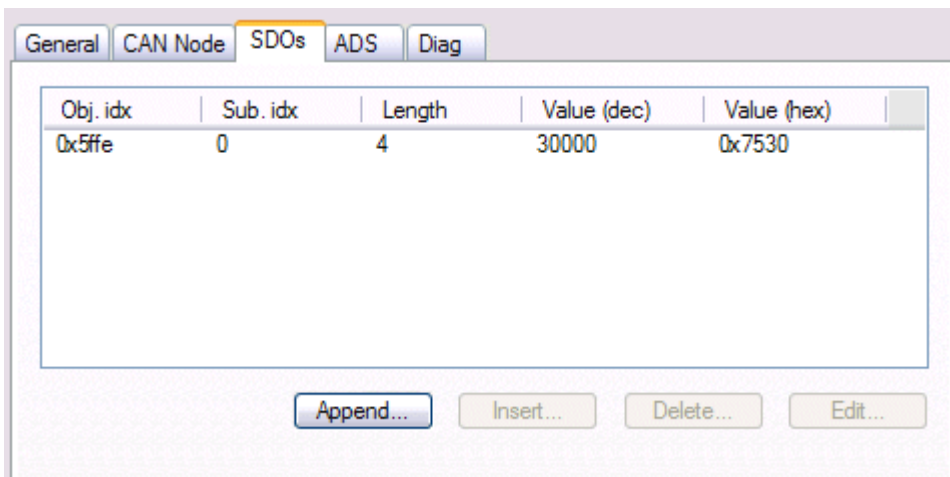
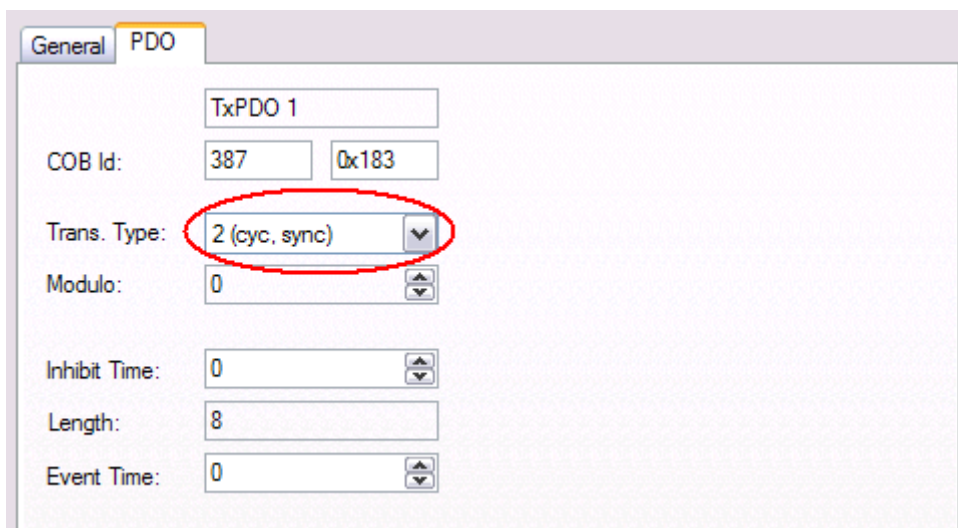

Fig. 72: Enabling the communication module

Sync telegram

In the default setting, the Lenze drive will send its output PDOs only once it has received a sync telegram from the CAN master. If you set the trans. type to 2, for example, the Lenze drive will send an output PDO after every second sync telegram it receives.



Sample project

- TwinCAT-System-Manager-File: (<https://infosys.beckhoff.com/content/1033/bx5100/Resources/tsm/3207301131.tsm>)



- TwinCAT-PLC-File: (<https://infosys.beckhoff.com/content/1033/bx5100/Resources/prx/3207303307.prx>)



4.2.11 Real-Time Clock (RTC)

A real-time-clock (RTC) with backup battery is implemented on the BX controller. The clock has a battery.

Setting the real-time clock

The simplest way of setting the clock is via the System Manager. When the ADS communication is operating normally, the current time is displayed on the BX controller. To adjust the time, simply edit the time, and adjust the day, month and year with the drop down key. For setting the year, click on the year display and specify the required year. Repeat the procedure for the month. Once all parameters have been set, click on *Update RTC on BX*.

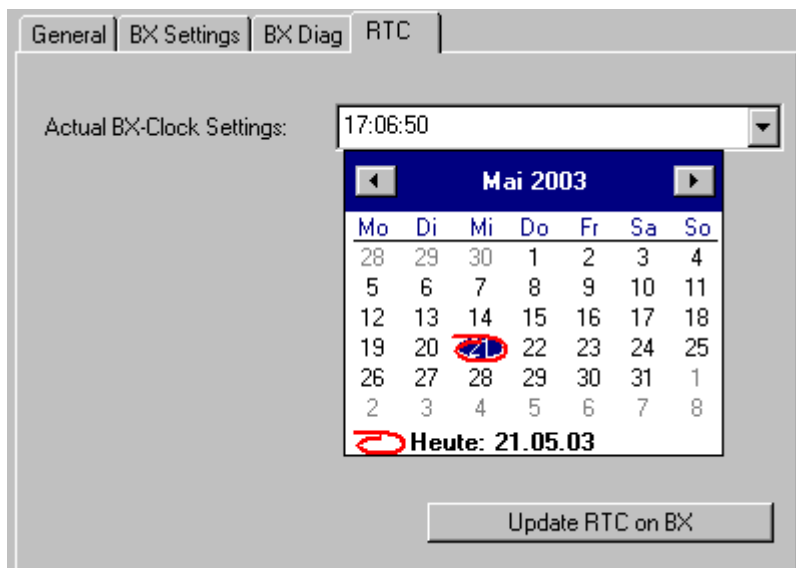

Fig. 73: Setting the real-time clock (RTC)



Service life of the battery

The service life of the battery may vary depending on utilization.

Reading the RTC on the BX controller (see example [▶ 109] ProgrammingLibrary)

The RTC can be read via a function block. Required libraries:

- TcSystemBX.lbx
- TCBaseBX.lbx

Writing the RTC to the BX controller

The RTC can be set via a function block. Required libraries:

- TcSystemBX.lbx
- TCBaseBX.lbx

Reading the RTC via ADS

Description	Meaning	Value
NETID	Target device	see System Manager "ADS"
Port	ADS port number	150 _{dec}
IDXGRP	IDX group	0x0000_F100 _{hex}
IDXOFFS	IDX Offset	0x0000_0000 _{hex}
Length	Length of the data	16 byte
Variable type	Type of variable	TIMESTRUCT

Writing of the RTC via ADS

Description	Meaning	Value
NETID	Target device	see System Manager "ADS"
Port	ADS port number	150 _{dec}
IDXGRP	IDX group	0x0000_F100 _{hex}
IDXOFFS	IDX Offset	0x0000_0000 _{hex}
Length	Length of the data	16 byte
Variable type	Type of variable	TIMESTRUCT

Setting via the navigation switch

See menu. [[▶ 76](#)]

Technical data for RTC

Accuracy: approx. 1 second/day

Duration for which the time is stored: approx. 3 months with fully charged battery

Service life of the battery: approx. 10 years for 10 cycles per day (1000 cycles for complete charge/discharge cycles)

4.2.12 COM port

The BX Controller has two serial interfaces. For PIN assignment please refer to [Hardware description \[\[▶ 25\]\(#\)\]](#).

Setting options:

Description	Selection
Baud rate [▶ 101]	9600 baud 19200 baud 38400 baud (starting with auto baud rate detection) 57600 baud 115200 baud (COM 2 only)
Data bits	7 8 (Default)
Parity	NONE ODD EVEN (Default)
Stop bits	1 (default) 2

COM 1

The COM 1 interface is used for communication with the KS2000 software or with TwinCAT PLC Control (login via serial interface).

COM 2

The COM 2 interface (with RS 232 or RS 485) is used for the application of user protocols or protocol libraries (such as ModbusRTU, RK512, etc.) for the connection of other serial devices.

Library

Function blocks are available for communication with the serial interface.

- [Documentation \[\[▶ 101\]\(#\)\]](#)
- [Example \[\[▶ 106\]\(#\)\]](#)
- [Library \[\[▶ 101\]\(#\)\]](#)

4.2.13 Menu

4.2.13.1 BX menu settings

To change into the menu, press the navigation switch for three seconds. The *Menu* directory appears first.

- You can change between the menu settings with the RIGHT/LEFT keys (the menu shown in row 1 is the active menu).
- Press the DOWN key for changing into a submenu.
- Press the UP key to return to the main menu.

Row 1 of the submenu shows the menu item, row 2 the current setting of this menu item.

Some settings cannot be changed (*read only*). These items are only intended to provide checks and to give the user information. To close the menu it is necessary to be in the main menu and then to hold the navigation switch down for three seconds.

Before settings can be changed, a password has to be set. The password remains stored even during a firmware update and through a reset to the factory settings. If you forget the password, the BX controller will have to be sent in.



Fig. 74: Navigation switches of the BX controller

Switch assignment

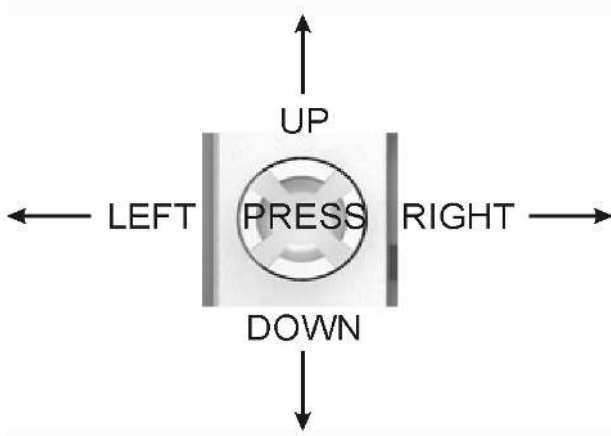

Fig. 75: Switch assignment

Main menu	Submenu 1st row	Submenu 2st row	Read/Write
MENU	Password	**** not set ???? set	See below
	Factory settings	Activate?	Pressing the key causes the factory setting to be reset and the controller to be rebooted automatically
	Reboot	Activate?	Pressing the key causes the controller to be rebooted
AMS	AMS	>AMS Net-ID<	read only
PLC	NAME	>current NAME<	read only
	Curr. Exex. Time	>current value<	[ms]
	Task time	>current value<	The cycle time can be set if the key is pressed
	Status	>Boot-Prj< >PLC Status<	Boot project exists PLC status
Config	NAME	>current NAME<	read only
	Delete config	Activate?	Pressing the right key causes the current configuration to be deleted
Real Time Clock	Date and Time	>current time<	read only
	Year	Setting	2003-2xxx
	Month	Setting	1-12
	Day	Setting	1-31
	Day of week	Setting	Mon, ... Fri
	Hour	Setting	0-23
	Minute	Setting	0-59
	Second	Setting	0-59
COM 1 <i>read only</i>	Baud rate	>current value<	9600/19200/38400/56800
COM 2 <i>read only</i>	Baud rate	>current value<	9600/19200/38400/56800/115k
SSB <i>read only</i>	Baud rate	>current value<	1MBaud, 500k, 250k, 125k, 100k, 50k
	Cycle Time	>current value< [in µs]	read only
	Utilization	>current value< [in %]	read only
K-bus <i>read only</i>	Diagnosis	>current diagnosis<	read only
	Number of Bus Terminals	>current value<	read only

Bus-specific menu items

BX3100

F-bus PROFIBUS <i>read only</i>	Address*	>current value<	1-126
	Baud rate*	>current value<	read only
	Status	>current value<	read only
	Diagnostic*	>current value<	read only

BX5100

F-bus CANopen <i>read only</i>	Address*	>current value<	1-126
	Baud rate*	>current value<	read only
	Status	>current value<	read only
	Diagnostic*	>current value<	read only

*) in preparation

BX9000

Ethernet	MAC ID	>current value<	000105-xx-xx-xx, read only
	ADDR.STATE	>current value<	read only
	ADDRESSING MODE	FIXED IP (default) DHCP BOOTP BOOTP & SAVE	read / write
	NAME	>current value<	BX_xxxxxx (xxxxxxx last 3 Bytes from the MAC ID) read / write
	DEFAULT GATEWAY	0.0.0.0	read / write
	IP MASK	255.255.0.0	read / write
	IP ADDRESS	172.16.21.20	read / write

Code

The default setting is "****", i.e. no password is active. A password is required for setting parameters.

Menu navigation

Press the navigation switch for three seconds to switch to the Directory menu. Some of the menu items are described below.

MENU

MENU Main Menu

DOWN (press briefly)

PASSWORD ???? - password set
 ???? **** - no password set

PRESS (press briefly)

PASSWORD ENTER? Do you want to enter the password
 ???? Yes - PRESS (press for approx. 2 seconds, then enter the password) / No - UP

PRESS (press for approx. 2 seconds, then enter the password)

PASSWORD Enter password
 ???? PRESS <OK>

PRESS

PASSWORD Enter password
 1234 OK <PRESS> and <PRESS> again to confirm (press for approx. 1 second until OK appears in the display)

F bus (only BX3100)

F-BUS Fieldbus status (read only)
WAIT FOR SETPRM WAIT FOR SETPRM - waiting for parameter data from PROFIBUS

SSB

SSB Smart System Bus

COM2

COM2 Serial interface COM2 (read only)

DOWN

Baudrate Current baud rate (read only)
xxx

COM1

COM1 Serial interface COM2 (read only)

DOWN

Baudrate Current baud rate (read only)
xxx

K-Bus

KBUS OK K-Bus diagnosis (read only)
10 TERMINALS

DOWN

KBUS RESET K-Bus reset

PRESS (short)

KBUS RESET EXCT? PRESS 1 sec - the K-Bus is reset

PLC

PLC PLC status (read only)

DOWN

PROJECT PLC project name
>NAME<

RIGHT

CURR. EXEC. TIME Total processing time in [ms]
xxx ms

RIGHT

CYCLE TIME Set cycle time
20 ms

4.2.13.2 Creating own menus

The display and the navigation switch can also be used for user-specific purposes, for example displaying diagnostic information or changing parameters. A simple example is provided that can be used and adapted to get you started.

 Download (<https://infosys.beckhoff.com/content/1033/bx5100/Resources/prx/3207305483.prx>):

4.2.14 Configuration software KS2000

Bus Terminal controllers of the BCxx50, BXxx20 and BXxx00 series cannot be parameterized and configured with the KS2000 configuration software. These devices must be configured with the TwinCAT System Manager.

The KS2000 configuration software offers configuration and diagnostic support for the Bus Terminals attached to the Bus Terminal Controller.

It is advisable to set the baud rate in the KS2000 configuration software and the BCxx50 BCxx20 and BXxx00 to 38400 baud (8 data bits, even, 1 stop bit).

● **COM1 - automatic baud rate detection**



The COM 1 interface of the BXxx00 features automatic baud rate detection between 9.6 kbaud and 56.4 kbaud.

● **Required KS2000 version**



Configuration or diagnostics of Bus Terminals at BXxx00 is supported from KS2000 version 4.3.14.

In some Bus Terminals (e.g. KL25xx, KL6811, KL6201, KL6401) the following parameters must be set in order to be able to use the configuration dialogs:

- A PLC project or boot project must be deactivated.
- The BX controller must be in its default configuration. Set the manufacturer's setting or switch to Config Mode in the TwinCAT System Manager (blue TwinCAT icon).
- The BX controller must be in FreeRun mode. Activate it with the TwinCAT System Manager.

You can now log in with the KS2000 configuration software via ADS (port 100) or the serial cable and use the KS2000 dialogs in the Bus Terminals.

5 Programming

5.1 PLC features of the BX controllers

Description	Value
Data memory	256 kbyte
Program memory	256 kbyte minus task-configuration minus POU's during online change
Source code memory	256 kbyte
RETAIN	2 kbyte
INPUT	2 kbyte
OUTPUT	2 kbyte
FLAG	4 kbyte
Max. variable size	16 kbyte
Max. POU's	Limited by memory

5.2 TwinCAT PLC

The Beckhoff TwinCAT Software System turns any compatible PC into a real-time controller with a multi-PLC system, NC axis control, programming environment and operating station. The TwinCAT programming environment is also used for programming the BC/BX. If you have TwinCAT PLC (Windows NT4/2000/XP) installed, you can use the fieldbus connection or the serial port for downloading and debugging software.

TwinCAT I/O or TwinCAT PLC can also be used as the Ethernet Master (host), in order to exchange process data with the Bus Terminal Controller. TwinCAT provides you with the System Manager as a configuration tool, as well as the drivers and the ADS protocol.

Bus Terminal Controllers of the BCxx50, BCxx20 and BXxx00 series

These 2nd-generation Bus Terminal Controllers are configured with the TwinCAT System Manager and programmed with TwinCAT PLC Control. TwinCAT PLC must be installed for these couplers (Windows NT4, Windows 2000, Windows XP).

Programming and program transfer

- via the serial interface [► 129]
- via the fieldbus interface (only for Bus Terminal controllers for PROFIBUS, CANopen and Ethernet)

Online change

The Bus Terminal Controllers of the BX series and the BCxx50 support online change. This means that the PLC program is replaced with a new program without interrupting the program. The switch-over to the new program occurs after the task is completed. This means that two versions of the PLC program have to be stored. 512 kbyte are available, which therefore have to be divided by two, leaving 256 kbyte for the actual PLC program. In addition, several kbyte are required for task configuration etc. During an online change, dynamic data are stored in memory. Should a program approach the memory limit (program size greater than 240 kbyte), the online change may no longer work, even though the program may still be written to the BX after "Rebuild all".

When is online change not available?

Online change is not available under certain conditions,.

- Inserting of a new library
- Changing the task setting
- "Rebuild all"

- Controller memory limit is almost reached (PLC program greater than 90%)

5.3 TwinCAT PLC - Error codes

Error type	Description
PLC compiler error	Maximum number of POU's (...) exceeded
PLC compiler error	Out of global data memory ...

Error POU's

For each function block one POU (process object unit) is created. 256 function blocks are available by default.

Error 3612: Maximum number of POU's (100) exceeded! Compile is aborted.

Data allocation

1 Error(s), 0 Warning(s).

Fig. 76: Maximum number of POU's exceeded

If libraries are integrated this value may be insufficient. In this case, the number of POU's should be increased.

To this end, open in PLC Control under Projects/Options...

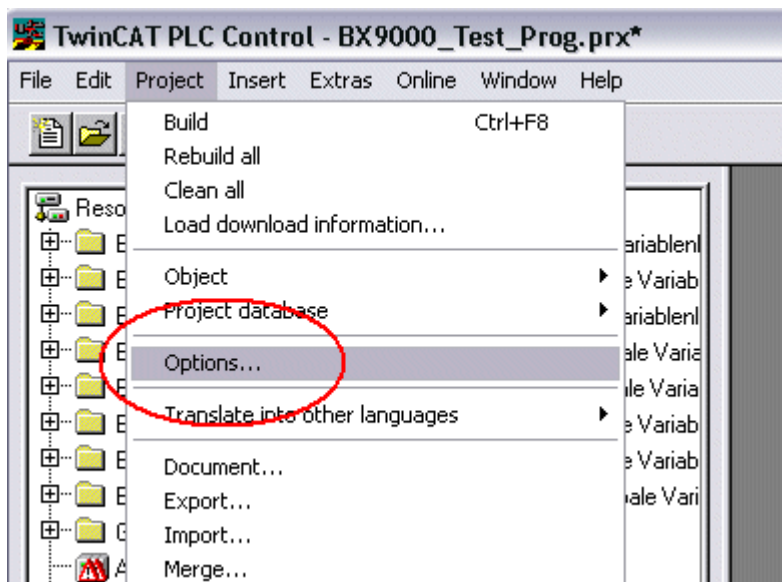

Fig. 77: Menu path Projects / Options / Controller Settings

...the controller settings.

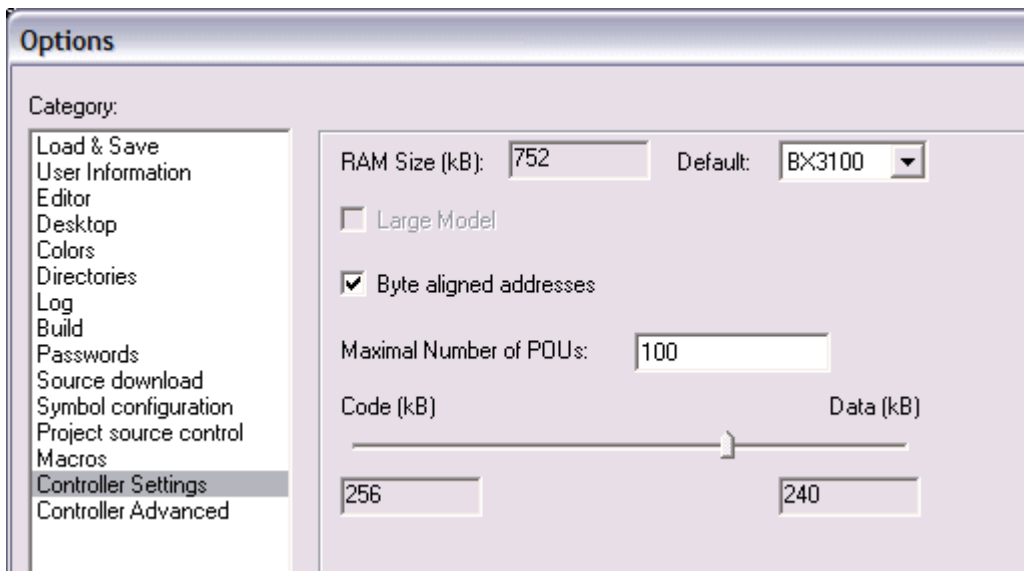

Fig. 78: Controller settings

Changing these settings will deactivate online changes.

Global memory error

```
Interface of POU 'MAIN'  
Data allocation  
Error 3803: MAIN (7): Out of global data memory. Variable 'Test_', 16002 bytes.  
1 Error(s), 0 Warning(s).
```

Fig. 79: Global memory insufficient

2 x 16 kbyte of data are available by default. If large data quantities are to be used, this range should be increased. A maximum of 14 data segments are possible for the BX.

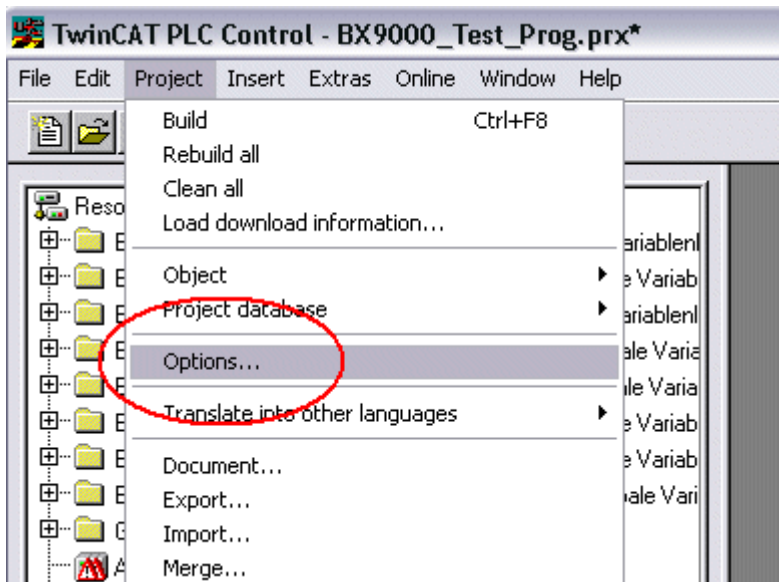

Fig. 80: Menu path Projects / Options / Build

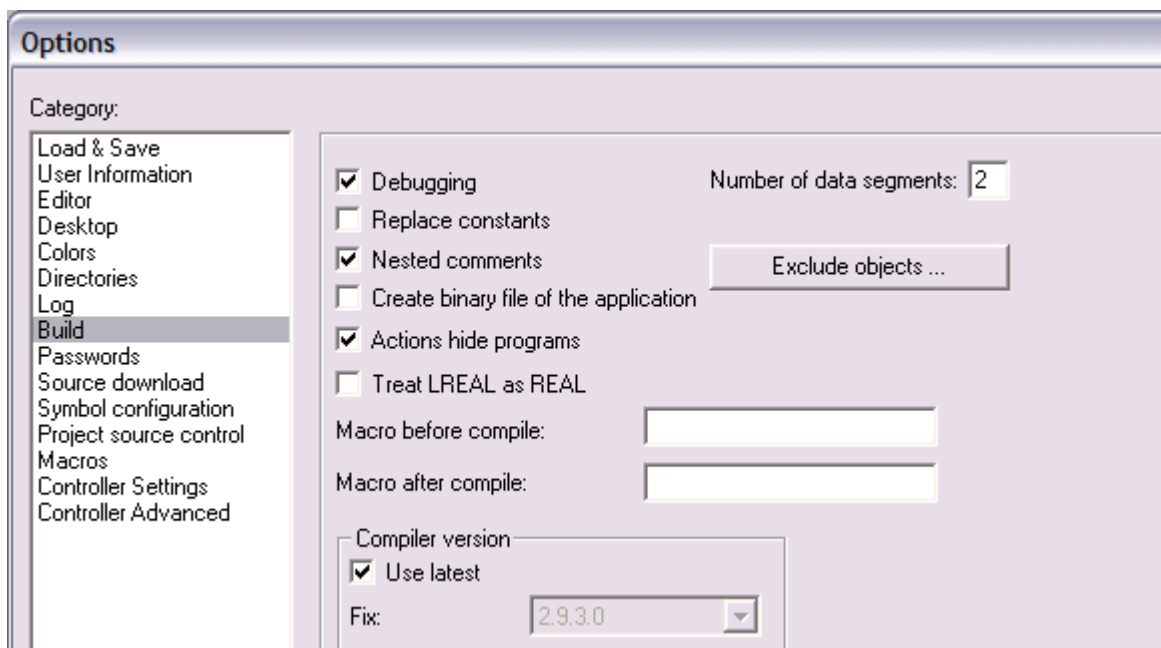

Fig. 81: Build

5.4 Persistent data

The Bus Terminal Controller has 1000 bytes of persistent data available. In contrast to the retain data, these are not deleted, even with a new project, a PLC reset or a new download.

In order to use the persistent data, these must first be activated once with a function block from the PLC.

Secondly, the variables should reside in the allocated flag area. Here you can choose where the persistent data reside.

4 kbytes of allocated flags are available, of which 1000 bytes can be declared as persistent data.

Example

```
VAR
  Test AT %MX1000 :BOOL;
  Count AT %MB1002 :INT;
END_VAR
```

The **Persistent_Data** function block can be used to specify the start address and the length (in bytes) from which the data are to be persistent.

The input variable *WriteOffset* is used to specify the byte offset of the flag area, *WriteSize* is used for the length in bytes.

The function block can be found in the TcSystemBX.lbx library. Should this not be available, it can be downloaded from this documentation (see [Libraries \[► 95\]](#)).

Example values

WriteOffset 1000
WriteSize 10

All data in the range %MB1000 - %MB1009 are then persistent. The variable type is irrelevant.

Like the retain data, the data are copied to the NOVRAM and are therefore writeable in each cycle.



Persistent data from firmware 1.17

Persistent data is supported for all BX controllers from firmware 1.17 or higher.

● Parameters are valid immediately

i The parameters only have to be written once, after which they are valid immediately. These data are stored permanently.
Activation of the factory setting deletes everything, including the persistent data.

Sample Program

Click on the link  (<https://infosys.beckhoff.com/content/1033/bx5100/Resources/prx/3207307659.prx>) to download a sample program from this documentation.

5.5 Remanent data

2000 kbyte of remanent data are available for the BX controller. These data are declared as VAR RETAIN in PLC Control:

Example

```
VAR RETAIN
  Test      :BOOL;
  Count     :INT;
END_VAR
```

Retain data are located between VAR RETAIN and END_VAR. These data are stored in a NOVRAM and are consistent across the whole 2 kbyte range. The RETAIN data are stored in the NOVRAM after each cycle. For 2 kbyte approx. 2 ms are required (for 1 kbyte approx. 1 ms). The variables can be configured locally or globally. Allocated variables (%MB, %QB, %IB) cannot be used as remanent data.

● Do not use VAR_RETAIN in function blocks

i VAR_RETAIN should not be used in function blocks. All FB data are copied into the retain memory. This leads to an unnecessary increase in cycle time, and the retain memory is filled with unnecessary data.

● Do not use variables with address as remanent data

i Variables that have been assigned an address (%MB, %QB, %IB) must not be used as remanent data.

Example for remanent data in the function block

This should be avoided, if possible, since all the data of a function block, in which even just a single remanent bit is found, are stored by default. A program sample can be found below.

Function block test (no program code required - in ST semicolon is sufficient)

```
FUNCTION_BLOCK Test
VAR_INPUT
END_VAR
VAR_OUTPUT
END_VAR
VAR
END_VAR
VAR_IN_OUT
  Counter :INT;
END_VAR
```

MAIN program

```
PROGRAM MAIN
VAR
  fb_Test:Test;
END_VAR
VAR_RETAIN
  iCounter1:INT;
END_VAR
fb_Test(Counter:=iCounter1);
```

5.6 Allocated flags

4 kbyte of allocated flags are available. They can be used to assign different variable types to the same address, e.g. for converting strings to bytes. Data can also be placed here that can be read or written via ADS by the controller.

● Allocated variables are not remanent data



For the Bus Terminal Controllers of the BX series and the BCxx50 the allocated variables are **not** saved as remanent data.

Reading/writing of allocated flags via ADS

The flags may also be read via the controller and ADS. In PROFIBUS, the DPV-1 services are used for this purpose, in CANopen SDO communication is used.

The AmsNetID can be obtained from the System Manager, or it can be displayed via the Bus Terminal Controller menu.

The PLC port number is 800.

Index group	Meaning	Index offset (value range)
0x4020	Flag (only BXxxx0)	0..4096

Example

BX program

```
VAR
  Flag_01 AT %MB0: WORD;
END_VAR
```

TwinCAT PC/CX master program

```
VAR
  fbADRSREAD: ADSREAD;
  Flag_M: WORD;
END_VAR

fbADRSREAD (
  NETID:='172.16.3.0.2.3' , (* AMSNetId BX *)
  PORT:=800 , (* 800 - PLC *)
  IDXGRP:=16#4020 , (* 0x4020hex falgs *)
  IDXOFFS:=0 , (* byte offset *)
  LEN:=2 , (* Lenght byte *)
  DESTADDR:=ADR(Merker) ,
  READ:=TRUE ,
  TMOUT:=t#1s );
IF NOT fbADRSREAD.BUSY THEN
  fbADRSREAD(READ:=FALSE);
END_IF
```

5.7 Local process image in delivery state

The process image of the Bus Terminal Controller consists of input, output and flag areas. In addition, there are unallocated data without fixed address. They are created without specifying an address. 256 kB of memory space is reserved on the Bus Terminal Controller for this type of variable. For the allocated data 2048 bytes of input data and 2048 bytes of output data are available. In the default configuration, i.e. in delivery state of the Bus Terminal Controller, all connected Bus Terminals are assigned a fixed address. The data for the CANopen communication are stored from address offset 1000dec. In the default configuration the number of CANopen data is 4 x kbyte (4 PDOs).

INPUTS	OUTPUTS
Bus Terminal %IB0 ...	Bus Terminal %QB0 ...
CANopen data (PLC variables) %IB1000 ...	CANopen data (PLC variables) %QB1000 ...
... %IB2047 maximum	... %QB2047 maximum

CANopen data

PDO number	Read/Write	BX process image
PDO 1	Rx/Tx	%IB1000...%IB1007/QB1000...%QB1007
PDO 2	Rx/Tx	%IB1008...%IB1015/QB1008...%QB1015
PDO 3	Rx/Tx	%IB1016...%IB1023/QB1016...%QB1023
PDO 4	Rx/Tx	%IB1024...%IB1031/QB1024...%QB1031

Further PDO data (5-32) have to be enabled by the master (see CAN configuration [► 44]).

Addressing of the connected Bus Terminals

The default setting is for all the connected Bus Terminals to be assigned to the local process image. Mapping in the Bus Terminal Controller is based on the following rule:
first all complex Bus Terminals, in the order they are connected, then the digital Bus Terminals, which are made up to a byte. The default mapping of the complex Bus Terminals is:

- complete evaluation
- Intel format
- Word alignment

Example

Bus Terminal Controller: 1 x BX5100
 Position 1: 1 x KL1012
 Position 2: 1 x KL1104
 Position 3: 1 x KL2012
 Position 4: 1 x KL2034
 Position 5: 1 x KL1502
 Position 6: 1 x KL3002
 Position 7: 1 x KL4002
 Position 8: 1 x KL6001
 Position 9: 1 x KL9010

Process image

Bus Terminal	Position	Input image	Output image
KL1501	5	%IB0...%IB5	%QB0...%QB5
KL3002	6	%IB6...%IB13	%QB6...%QB13
KL4002	7	%IB14...%IB21	%QB14...%QB21
KL6001	8	%IB22...%IB29	%QB22...%QB29
KL1012	1	%IX30.0..30.1	-
KL1104	2	%IX30.1..30.5	-
KL2012	3	-	%QX30.0..30.1
KL2034	4	-	%QX30.2..30.5
KL9010	9	-	-

i Address of the Bus Terminals at the local PLC

If you do not know the address of the Bus Terminals that you have assigned to the local PLC (BCxx00):

Perform your hardware configuration in the System Manager. After you have entered all the Bus Terminals and PLC variables, click with the right mouse button on the BCxx00 in the hardware tree, and select the menu item Export variables information.... A file is saved, and this file can be inserted in the System Manager under Project - Import. Now you will have the entry TwinCAT import under the global variables, and you will find here all the variables that you have assigned to the local PLC (BCxx00).

5.8 Mapping the Bus Terminals

The precise assignment of the byte-oriented Bus Terminals may be found in the configuration guide for the particular bus terminal. This documentation is available on the Beckhoff *Products & Solutions* CD or on the Internet under <http://www.beckhoff.de>.

Byte oriented Bus Terminals	Bit oriented Bus Terminals
KL15x1	KL10xx, KL11xx, KL12xx, KL17xx, KM1xxx
KL25xx	KL20xx, KL21xx, KL22xx, KL26xx, KL27xx, KM2xxx
KL3xxx	
KL4xxx	
KL5xxx	
KL6xxx	
KL7xxx	
KL8xxx	
	KL9110, KL9160, KL9210, KL9260

5.9 Creating a boot project

The following memory resources are available for generating the boot project

- approx. 250 kbyte flash on the Bus Terminal controllers of the BX series;
- approx. 48 kbyte flash on the Bus Terminal controllers of the BCxx50 series.

PLC Control

After logging into TwinCAT PLC Control, a boot project can be created.

- Opening a PLC project
- Selecting the target system (or selection the serial interface)
- Logging into the BX/BCxx50
- Creating a boot project (Online\Create boot project)

The PLC LED lights up green once a valid boot project is available on the BX/BCxx50.

In the Bus Terminal controllers of the BX series, the PLC LED flashes orange while boot project is created. The PLC LED lights up orange if no boot project is available on the BX.

Deleting a boot project

The boot project can be deleted from the Bus Terminal Controller. The following steps must be followed:

- Opening the project
- Logging into the Bus Terminal Controller
- Deleting the boot project (Online\Delete boot project)

The PLC LED lights up orange when the boot project is deleted.

Using the current project as boot project

After an online change the old project is still shown as boot project. To use the current project (after the online change) as the boot project, the boot project has to be recreated.

Bypassing the start of the boot project*

With the Bus Terminal controllers of the BX series, starting of the boot project during booting can be prevented by pressing the Navi button. This does not delete the boot project. The project is reloaded when the Bus Terminal Controller is rebooted.

* from version 0.85

5.10 Local process image in the TwinCAT configuration

The TwinCAT configuration (TwinCAT CONFIG) enables free mapping between fieldbus, K-bus and PLC variables. Variables can be linked independent of their address via the System Manager.

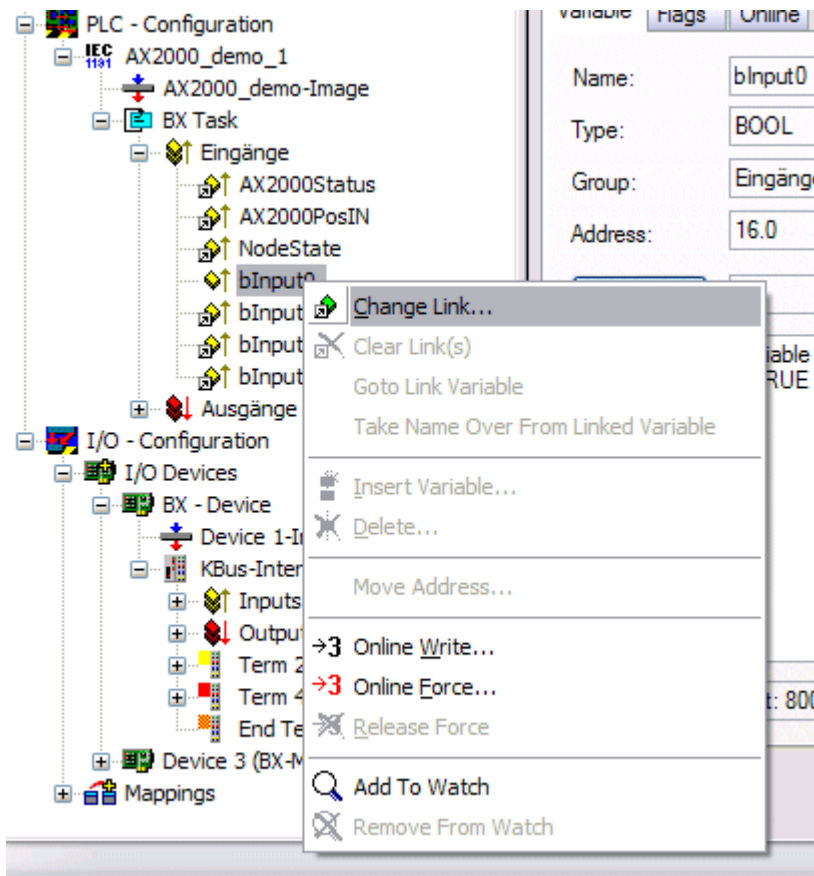

Fig. 82: Changing variable links

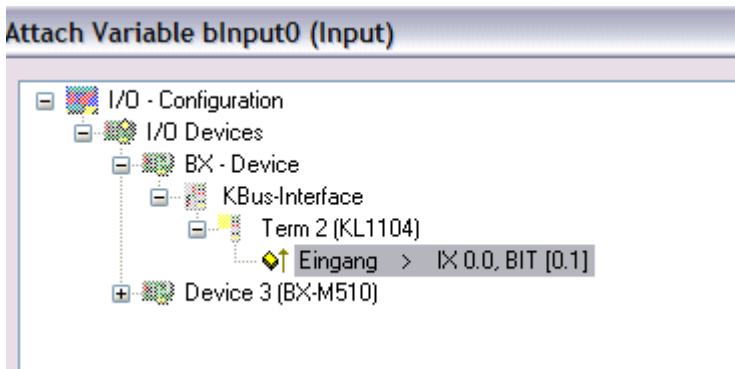

Fig. 83: Linking a variable with an input

In the default configuration all Bus Terminals are assigned fixed addresses. If a Bus Terminal is inserted, the whole address range may be shifted. The TwinCAT configuration enables allocated variables to be linked to a Bus Terminal, as required. This is parameterized in the System Manager, and the configuration is then downloaded to the Bus Terminal Controller (see [TwinCAT configuration](#) ▶ 341). It is also possible to upload an existing TwinCAT configuration.

5.11 Communication between TwinCAT and BX/BCxx50

For transferring data from TwinCAT to the Bus Terminal Controller, it makes sense to organize the data in a structure. Please note the following to account for the differences in data management on the two systems.

- If two different data types are sent in sequence (e.g. byte and INT), the following variable is set to the next even address offset
- Boolean variables should never be allocated individually within a structure, since they would invariably occupy 1 byte. Boolean expressions should always be masked in a byte or word.

Example 1: A structure on the BX/BCxx50 and on the PC

Variable	BX/BCxx50 memory	PC memory (TwinCAT)
Byte	%..B0	%..B0
INT (1)	%..B2	%..B1
INT (2)	%..B4	%..B3

Due to the fact that another variable type (INT) follows the first byte, in the BX/BCxx50 it was assigned the next free even address. In order to achieve the same data structure on both systems, a dummy byte has to be inserted in the PC project (see example 2).

Example 2: A structure on the BX/BCxx50 and on the PC with the same memory allocation

Variable	BX/BCxx50 memory	PC memory (TwinCAT)
Byte	%..B0	%..B0
Byte (dummy)	%..B1 (not necessarily required, since the system deals with this itself if the variable does not exist)	%..B1
INT (1)	%..B2	%..B2
INT (2)	%..B4	%..B4

Data structure

```
Type PB_Data
STRUCT
  wVar_1:WORD;
  iValue_1:INT;
  iValue_2:INT;
  iValue_3:INT;
END_STRUCT
END_TYPE
```

Creating a variable structure

```
VAR_Global
  strData_Out AT %QB1000:PB_Data; (*PLC Variables *)
  bInput_01 AT %IX0.0:BOOL; (* Input from a terminal *)
END_VAR
```

Small programming example

```
strData_Out.wVar_1.0:=bInput_01;
```

● Do not use real values in a mixed data structure



A mixed data structure should not contain real values. If this is nevertheless the case, the high and low words must be swapped in the BX/BCxx50 or in the TwinCAT master project. It is better to use an array of Real values or to transfer the Real values individually.

● Larger fieldbus data blocks



You can transfer larger fieldbus data blocks, in order to have a reserve for your structure. Disadvantage: These reserves are then transferred with each fieldbus telegram, resulting in overload of the fieldbus communication.

5.12 Up- and downloading of programs

The Bus Terminal Controller has a memory for the source code. It can be used for storing the program, the task configuration, and the libraries. Should the memory be insufficient, the source code may be stored without task configuration and libraries. This takes up significant less memory space!

General settings

The timing of the source code download to the target system can be specified via Edit/Options. Open the options menu.

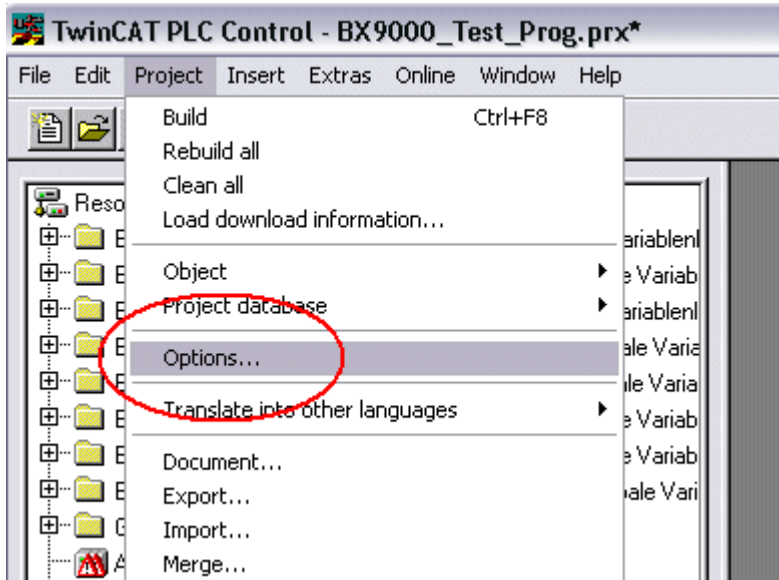

Fig. 84: Opening the options menu

Select Source Download.

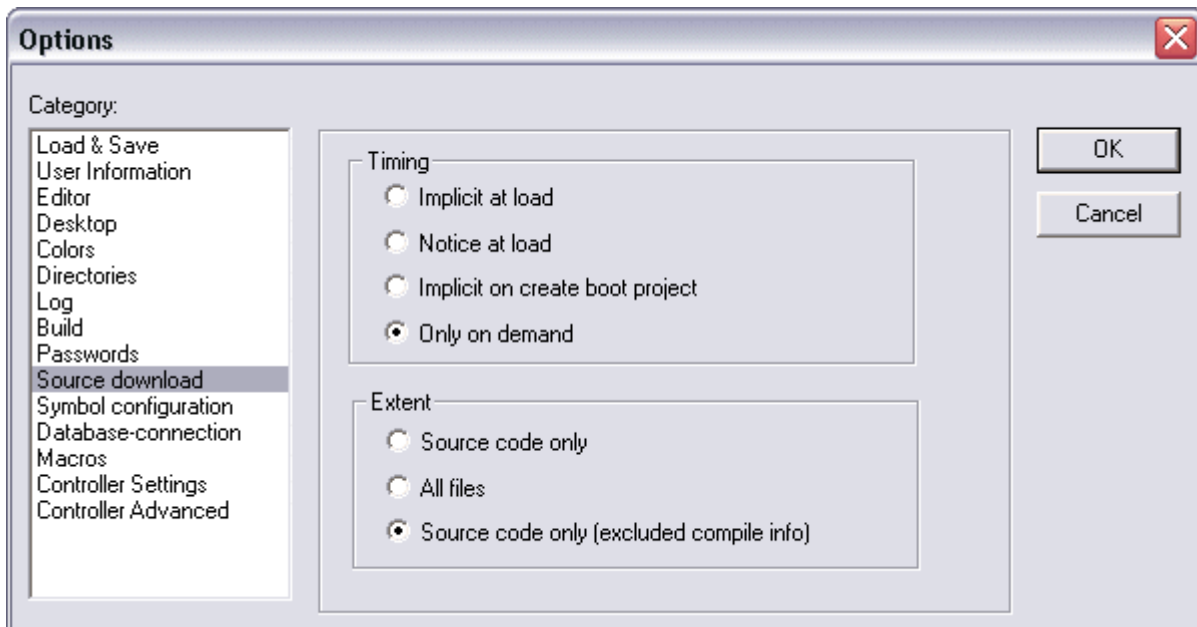

Fig. 85: Selecting Source Download

Here you can set which parts of the source code are to be downloaded to the Bus Terminal Controller, and when.

Source code only: the prx file with information on the online change is transferred. Login via online change is possible (the PLC does not stop).

All files: as *Source code only*, plus all required libraries.

Source code only (compile info excluded): only the prx file is transferred. Login is only possible when the PLC stops.

Which option you can use depends on the size of your projects.

Downloading a program

The source code can be transferred to the target system on request. This requires the user to be logged in with his program. Under Online/Source code download the program code can now be transferred to the Bus Terminal Controller.

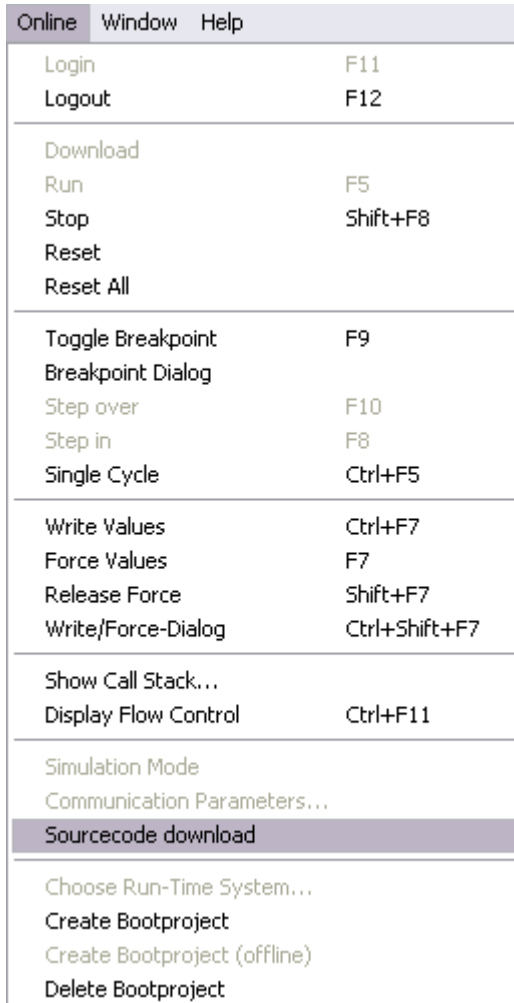

Fig. 86: Downloading the program code

After a short delay, a window will open that indicates the download progress.

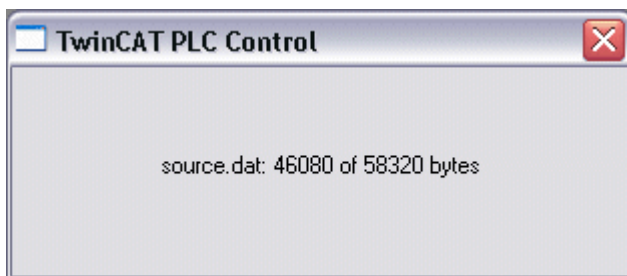

Fig. 87: Download progress

Uploading a program

For uploading the program code again, open a new file in PLC Control. Then click on the PLC button.

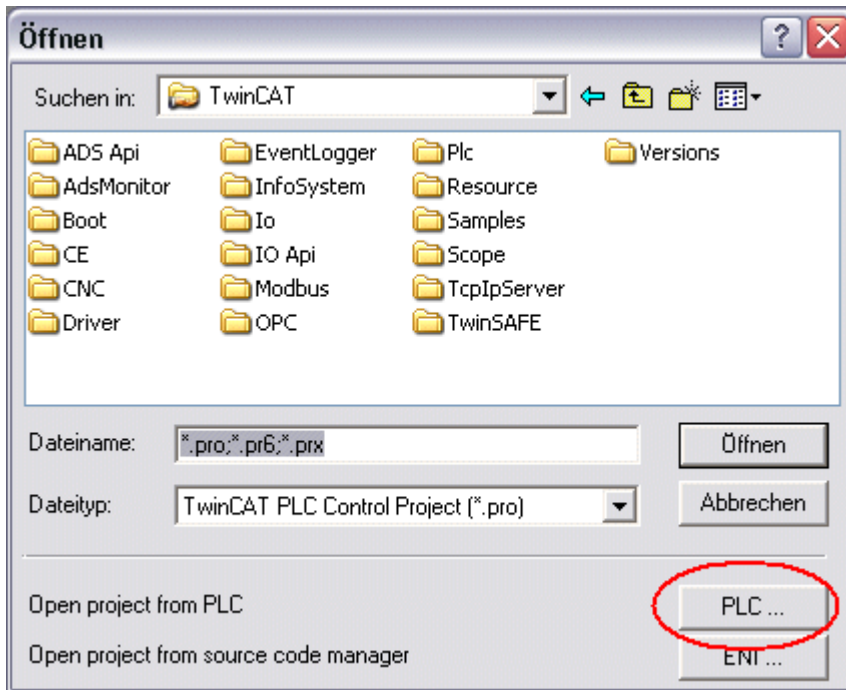

Fig. 88: Uploading a program

Select the data transfer route:

- *BCxx50 or BX via AMS*, if you are connected to the Bus Terminal Controller via the fieldbus, or
- *BCxx50 or BX via serial*, if you are connected to the Bus Terminal Controller via the serial interface.

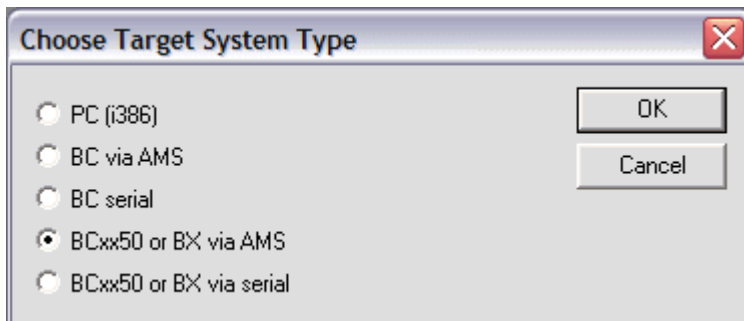

Fig. 89: Selecting the data transfer route

Then select the device and confirm with OK.

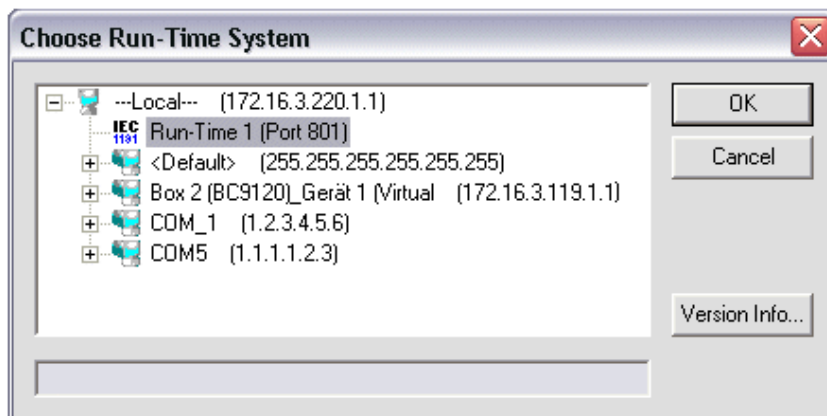

Fig. 90: Selecting the device

The source code will now be uploaded.

Password

You can protect your project with a password (in PLC Control Project/Options/Passwords).

5.13 Libraries

5.13.1 Libraries overview

Various libraries are available for the Bus Terminal Controllers (Bus Coupler with PLC functionality: BXxxxx) (see [Beckhoff Information System](#)).

Download

To download the libraries click on the link. Please copy the libraries to directory TwinCAT\PLC\LIB.

- Standard (<https://infosys.beckhoff.com/content/1033/bx5100/Resources/zip/3207309835.zip>)



- TcSystemBX (<https://infosys.beckhoff.com/content/1033/bx5100/Resources/zip/3207312011.zip>)



(the TcSystemBX requires the TcBaseBX library)

- TcBaseBX (Download)



(TcDisplayBX, TcNaciSwitchBX and TcDebugBX are now included here)

- TcComPortBX (<https://infosys.beckhoff.com/content/1033/bx5100/Resources/zip/3207314187.zip>)



- ChrAscBX.lbx (<https://infosys.beckhoff.com/content/1033/bx5100/Resources/zip/3207316363.zip>)



i Use the library that matches the firmware

The latest firmware requires the latest library. If you update your BX Controller, please also change the libraries.

Copy these libraries to the LIB directory, remove these libraries from your project and add them again.

TcSystemBX

ADS	Version	Firmware				
		BX3100	BX5100	BX5200	BX8000	BX9000
ADSREAD	04.03.04	0.90	0.14	1.00	0.02	1.00
ADSWRITE	04.03.04	0.90	0.14	1.00	0.02	1.00
ADSRDWRT	04.03.04	0.90	0.14	1.00	0.02	1.00
ADSWRTCTL	04.03.04	0.90	0.14	1.00	0.02	1.00
ADSRDSTATE	04.03.04	0.90	0.14	1.00	0.02	1.00
ADSRDDEVINFO	04.03.04	0.90	0.14	1.00	0.02	1.00

Bit Functions	Version	Firmware				
		BX3100	BX5100	BX5200	BX8000	BX9000
CLEARBIT32	07.03.03	0.28	0.01	1.00	0.01	1.00
CSETBIT32	07.03.03	0.28	0.01	1.00	0.01	1.00
GETBIT32	07.03.03	0.28	0.01	1.00	0.01	1.00
SETBIT32	07.03.03	0.28	0.01	1.00	0.01	1.00

Display Function	Version	Firmware				
		BX3100	BX5100	BX5200	BX8000	BX9000
FB_DispWrite [▶_108]	31.03.03	0.28	0.01	1.00	0.01	1.00

Diagnosis	Version	Firmware				
		BX3100	BX5100	BX5200	BX8000	BX9000
BX_Security	15.08.06	1.12	1.14	-	1.12	1.14
DeviceTyp	15.08.06	1.12	1.14	-	1.12	1.14
FirmwareVersion	15.08.06	1.12	1.14	-	1.12	1.14
FirmwareVersionSt ring	15.08.06	1.12	1.14	-	1.12	1.14
DeviceTyp	15.08.06	1.12	1.14	-	1.12	1.14
Read_Diagnose	15.08.06	1.12	1.14	-	1.12	1.14
CRCBootproject	15.08.06	1.14	1.14	-	1.14	1.14

Read Address	Version	Firmware				
		BX3100	BX5100	BX5200	BX8000	BX9000
ReadSlaveAddress	15.08.06	1.12	1.12	1.10	1.12	-

Controller	Version	Firmware				
		BX3100	BX5100	BX5200	BX8000	BX9000
FB_BasicPID	04.03.04	0.64	0.01	1.00	0.01	1.00

Event Logger Functions	Version	Firmware				
		BX3100	BX5100	BX5200	BX8000	BX9000
-	-	-	-	-	-	-

File Access	Version	Firmware				
		BX3100	BX5100	BX5200	BX8000	BX9000
FB_ReadFromFile	03.08.04	1.04	1.04	1.00	1.04	1.00
FB_WriteToFile	03.08.04	1.04	1.04	1.00	1.04	1.00
FB_ReadWriteFile	03.08.04	1.04	1.04	1.00	1.04	1.00

Memory Func- tions	Version	Firmware				
		BX3100	BX5100	BX5200	BX8000	BX9000
MEMCMP	07.03.03	0.41	0.01	1.00	0.01	1.00
MEMCYP	07.03.03	0.41	0.01	1.00	0.01	1.00
MEMMOVE	07.03.03	0.41	0.01	1.00	0.01	1.00
MEMSET	07.03.03	0.41	0.01	1.00	0.01	1.00

NOVRAM Functions	Version	Firmware				
		BX3100	BX5100	BX5200	BX8000	BX9000
-	-	-	-	-	-	-

Serial Communication Interface	Version	Firmware				
		BX3100	BX5100	BX5200	BX8000	BX9000
FB_COMPortClose	14.07.03	0.49	0.01	1.00	0.01	1.00
FB_COMPortOpen	14.07.03	0.49	0.01	1.00	0.01	1.00
F_COMPortRead	14.07.03	0.49	0.01	1.00	0.01	1.00
F_COMPortWrite	14.07.03	0.49	0.01	1.00	0.01	1.00

SFC	Version	Firmware				
		BX3100	BX5100	BX5200	BX8000	BX9000
AnalyzeExpression	07.03.03	0.28	0.01	1.00	0.01	1.00
AppendErrorString	07.03.03	0.28	0.01	1.00	0.01	1.00
SFCActionControl	07.03.03	0.28	0.01	1.00	0.01	1.00

System / Time / TBus	Version	Firmware				
		BX3100	BX5100	BX5200	BX8000	BX9000
DRAND	07.03.03	0.28	0.01	1.00	0.01	1.00
RTC	07.03.03	0.28	0.01	1.00	0.01	1.00
SYSTEMTIME_TO_DT	07.03.03	0.28	0.01	1.00	0.01	1.00
DT_TO_SYSTEMTIME	07.03.03	0.28	0.01	1.00	0.01	1.00
GetSysTick	14.07.03	0.49	0.01	1.00	0.01	1.00
PresetSysTick	14.07.03	0.49	0.01	1.00	0.01	1.00
Reboot	21.07.03	0.59	0.14	1.00	0.02	1.00
Persistent_Data	21.08.07	1.17	1.17	-	1.17	1.17

Debug	Version	Firmware				
		BX3100	BX5100	BX5200	BX8000	BX9000
F_ReadDebugTimer [▶ 107]	08.08.03	0.59	0.14	1.00	0.02	1.00
F_StartDebugTimer [▶ 107]	08.08.03	0.59	0.14	1.00	0.02	1.00

NaviSwitch	Version	Firmware				
		BX3100	BX5100	BX5200	BX8000	BX9000
All function blocks [▶ 107]	10.10.03	0.64	0.14	1.00	0.02	1.00

TcComPortBX

Com FBs	Version	Firmware				
		BX3100	BX5100	BX5200	BX8000	BX9000
All function blocks [▶ 113]	20.08.03	0.60	0.02	1.00	0.01	1.00

5.13.2 TcBaseBX

5.13.2.1 System task information

```
VAR_GLOBAL
    SystemTaskInfoArr : ARRAY[1..2] OF SYSTEMTASKINFOTYPE;
END_VAR
```

System flags are implicitly declared variables. Using the Input Assistant, a variable SystemTaskInfoArr can be found under system variables. This variable is a field with four structures of type `SYSTEMTASKINFOTYPE` [► 98]. The structure definition can be found in the system library. The index in this field is the task ID.

Development environment	Target platform	PLC libraries to be linked
TwinCAT v2.9.0	BX Controller	TcBaseBX.lbx

5.13.2.2 System task information type

```
TYPE SYSTEMTASKINFOTYPE
STRUCT
    active           :      BOOL;
    taskName        :      STRING(16);
    firstCycle      :      BOOL;
    cycleTimeExceeded :    BOOL;
    cycleTime       :      UDINT;
    lastExecTime    :      UDINT;
    priority        :      BYTE;
    cycleCount      :      UDINT;
END_STRUCT
END_TYPE
```

Legend

- active: This variable indicates whether the task is active.
- taskName: the task name.
- firstCycle: During the first PLC task cycle, this variable has the value: TRUE.
- cycleTimeExceeded: this variable indicates whether the set task cycle time was exceeded.
- cycleTime: set task cycle time in multiples of 100 ns.
- lastExecTime: cycle time required for the last cycle in multiples of 100 ns.
- priority: set task priority.
- cycleCount: cycle counter.

Development environment	Target platform	PLC libraries to be linked
TwinCAT v2.9.0	BX Controller	TcBaseBX.lbx

5.13.2.3 System info

```
VAR_GLOBAL
    SystemInfo : SYSTEMINFOTYPE;
END_VAR
```

System flags are implicitly declared variables. Using the Input Assistant, a variable Systeminfo can be found under system variables. The type `SYSTEMINFOTYPE` [► 98] is declared in the system library. For accessing the variable, the system library has to be integrated in the project.

Development environment	Target platform	PLC libraries to be linked
TwinCAT v2.9.0	BX Controller	TcBaseBX.lbx

5.13.2.4 System information type

```
TYPE SYSTEMINFOTYPE
STRUCT
    runTimeNo :      BYTE;
    projectName :    STRING(32);
END_STRUCT
```

```

    numberOfTasks      :      BYTE;
    onlineChangeCount  :      UINT;
    bootDataFlags      :      BYTE;
    systemStateFlags   :      WORD;
END_STRUCT
END_TYPE

```

Legend

runTimeNo: specifies the number of the runtime system (1).
 projectName: project name as STRING.
 numberOfTasks: number of tasks contained in the runtime system (max. 2).
 onlineChangeCount: number of online changes since the last complete download.
 bootDataFlags: Reserved
 systemStateFlags: Reserved.

Development environment	Target platform	PLC libraries to be linked
TwinCAT v2.9.0	BX Controller	TcBaseBX.lbx

5.13.2.5 ADS

5.13.2.5.1 Local ADS Port Numbers - Overview

Port number	Description
100 [▶ 99] _{dec}	Reading and writing of registers and tables from the coupler and the complex Bus Terminals
150 [▶ 74] _{dec}	Reading and writing of RTC (real-time clock)
153 [▶ 57] _{dec}	SSB - reading of the emergency message
800 [▶ 99] _{dec}	Local process image of the PLC, see also port 801
801 [▶ 99] _{dec}	Local process image of the PLC, see also port 800
0x1000 + node ID [▶ 56]	SSB - SDO communication with CANopen node (slave number)

5.13.2.5.2 ADS services

Local Process Image PLC Task 1 Port 800/801

Data can be read from and written to the local process image. If it is necessary for outputs to be written, it is important to ensure that they are not used by the local PLC, because the local controller will overwrite these values. The data are not associated with a watchdog, and therefore must not be used for outputs that would have to be switched off in the event of a fault.

Index group	Meaning	Index offset (value range)
0xF020	Inputs	0...2047
0xF021	Bit inputs	0...16376
0xF030	Outputs	0...2047
0xF031	Bit outputs	0...16376
0x4020	Flags	0...4095
0x4021	Flag bit	0...32760

ADS services

AdsServerAdsState

Data type (read only)	Meaning
String	Start - the local PLC is running Start - the local PLC is stopped

AdsServerDeviceState

Data type (read only)	Meaning
INT	0 - Start - the local PLC is running 1 - Stop - the local PLC is stopped

AdsServerType

Data type (read only)	Meaning
String	BX PLC Server

ADSWriteControl

Data type (write only)	Meaning
NetID	Net ID of the Ethernet Controller*
Port	800
ADSSTATE	5 - RUN / 6 - STOP
DEVSTATE	0
LEN	0
SRCADDR	0
WRITE	rising edge starts the function block
TMOU	example: T#1000 ms

* BC9050, BC9020, BC9120, BX9000

Register access port 100

On the Bus Terminal Controllers of the BX series, and on the BCxx50/xx20, the ADS port number for register communication is fixed at 100.

Index group	Index offset (value range)		Meaning
	Hi-Word	Low Word	
0 [READ ONLY]	0...127	0...255	Registers in the Bus Coupler Hi-Word, table number of the Bus Coupler Lo-Word, register number of the table
1...255	0...3	1...255	Register of the Bus Terminals Hi-Word, channel number Lo-Word, register number of the Bus Terminal

● Minimum timeout

i For reading the registers, ensure that the timeout for the ADS function block is set to more than one second.

● Setting the password

i When writing to the registers, the password has to be set (see the documentation for the particular Bus Terminal).

5.13.2.5.3 Deactivating the LED for cycle time exceeding

The BX controller monitors the set task cycle time. If it is exceeded, the `cycleTimeExceeded` [► 98] bit and the red PLC LED are set. In some applications the value may be exceeded for short periods, which is tolerable. This may be the case when many data are received in serial communication, for example. In order to avoid flickering of the red PLC LED, it can be switched off via ADSWRITE.

Structure of the ADSWRITE command

This ADSWRITE command enables the red PLC LED of the BX controller to be deactivated.

Input parameters	Description
NETID	local NetId of BX
Port number	800
IDXGRP	16#0000_4080
IDXOFFS	0
LEN	1 bytes
SRCADDR	Pointer on 1 bytes 0: red LED ON 1: red LED OFF

5.13.2.6 COM Port

5.13.2.6.1 COM port - overview

The library includes function blocks that enable data exchange between the **BXxxxx** Bus Controller and a remote partner. The maximum COM buffer is 512 bytes for both directions.

Function blocks

Name	Description
<code>FB_ComPortOpen</code> [► 103]	Opens a serial connection to a partner.
<code>FB_ComPortClose</code> [► 103]	Closes a serial connection to a partner.

Functions

Name	Description
<code>F_ComPortRead</code> [► 102]	Reading data from the COM buffer
<code>F_ComPortWrite</code> [► 102]	Writing data into the COM buffer

Supported baud rates

Baud rate [baud]	COM 1	COM 2
300	NO	YES
600	NO	YES
1200	NO	YES
2400	NO	YES
4800	NO	YES
9600	YES	YES
19200	YES	YES
38400	YES	YES
57600	YES	YES
115200	NO	YES

Further helpful function blocks can be found in [TcComPortBX.lbx](#) [► 112].

- Function block for using ComLib, ModbusRTU etc. for the BX COM ports
- Function block for communication with the BK8x00 Bus Couplers
- Function block for emulation of a BK8x00 slave

5.13.2.6.2 COM port functions

COM Port Read

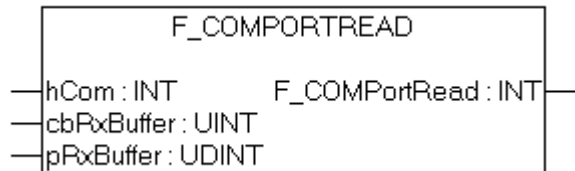

Fig. 91: Function block F_COMPORTRREAD

FUNCTION F_COMPORTRREAD

VAR_INPUT

```
hCom      :INT;
cbRxBuffer :UINT;
pRxBuffer :UDINT;
```

Legend

hCom: is connected with the iHandle of FB_COMPORTOPEN

cbRxBuffer: maximum length of data that can be read.

pRxBuffer: pointer to data to be written with the COM buffer content

Return value	Meaning
> 0	Number of bytes that is to be copied from the COM buffer into the PLC.
0x8000	Memory overflow

COM Port Write

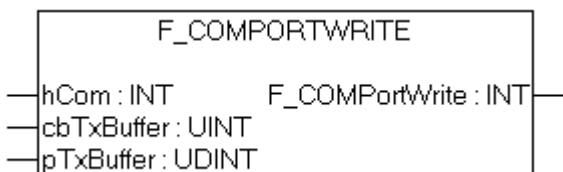

Fig. 92: Function block F_COMPORTRWRITE

FUNCTION F_COMPORTRWRITE

VAR_INPUT

```
hCom      :INT;
cbTxBuffer :UINT;
pTxBuffer :UDINT;
```

Legend

hCom: is connected with the iHandle of FB_COMPOROPEN

cbTxBuffer: Number of data bytes that were copied into the COM buffer.

pTxBuffer: Pointer to the data from which the COM buffer is to be filled.

Return value	Meaning
> 0	Number of bytes that is to be copied into the COM buffer from the PLC
0x8000	Memory overflow

5.13.2.6.3 COM port function block

COM Port Open

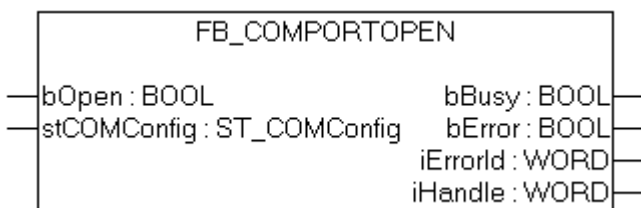

Fig. 93: Function block FB_COMPOROPEN

FUNCTION_BLOCK FB_COMPOROPEN

VAR_INPUT

```
bOpen      :BOOL;
stComConfig :ST_COMCONFIG;
```

Legend

bOpen: rising edge starts the function block
 stComConfig [[▶ 104](#)]: COM interface data structure

VAR_OUTPUT

```
bBusy      :BOOL;
bErr       :BOOL;
iErrId     :WORD;
iHandle    :WORD;
```

Legend

bBusy: The function block is active as long it is TRUE.
 bErr: Error bit.
 iErrId: Error number.
 iHandle: pointer transfer.

Return parameter iErrId	Meaning
0	No error
-1, 0xFFFF	Incorrect COM port
-2, 0xFFFE	Incorrect or unsupported baud rate. Check the parameter stComConfig.BaudRate.
-3, 0xFFFD	Incorrect data format. Check the parameter stComConfig.
-4, 0xFFFC	Incorrect initialization of the COM interface
-5, 0xFFFB	Unsupported instance
-6, 0xFFFA	Incorrect size of the RX buffer
-7, 0xFFFF9	Incorrect size of the TX buffer
-8, 0xFFFF8	COM port is blocked

COM Port Close

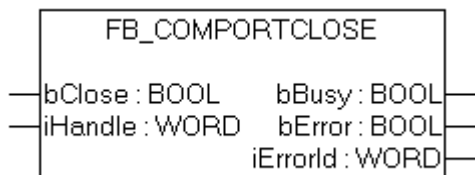

Fig. 94: Function block FB_COMPORTCLOSE

FUNCTION_BLOCK FB_COMPORTCLOSE

VAR_INPUT

```
bOpen      :BOOL;
iHandle    :WORD;
```

Legend

bClose: rising edge starts the function block
 iHandle: pointer transfer of FB_COMPORTCLOSE.

VAR_OUTPUT

```
bBusy      :BOOL;
bErr       :BOOL;
iErrId     :WORD;
```

Legend

bBusy: The function block is active as long it is TRUE.
 bErr: Error bit.
 iErrId: Error number.

Return parameter iErrId	Meaning
0	No error
> 0	error number (#not documented#)

5.13.2.6.4 ComConfig data structure

The settings for the serial interfaces of the BX are transferred with the following data structure.

```
TYPE ST_COMConfig:
STRUCT
    cbRxBufferLen :WORD;
    cbTxBufferLen :WORD;
    dwMode        :DWORD;
    BaudRate      :DWORD;
    eCommPort     :E_CommPort;
```

```
eDataBits      :E_DataBits;  
eParity        :E_Parity;  
eStoppBits     :E_StoppBits;  
END_STRUCT  
END_TYPE
```

Legend

cbRxBufferLen: Has no purpose (was retained for compatibility reasons)

cbTxBufferLen: Has no purpose (was retained for compatibility reasons)

dwMode: data mode COM 1 only "0" - COM 2 RS232 "0" and RS485 "1"

BaudRate: Baud rate

eCommPort: Com Port COM1/COM2

eDataBits: number of data bits SEVEN_DATABITS/EIGHT_DATABITS

eParity: EVEN/ODD/NONE

eStoppBits: Number of stop bits ONE_STOPPBIT/TWO_STOPPBITS

5.13.2.6.5 Example

ST sample program



Download (<https://infosys.beckhoff.com/content/1033/bx5100/Resources/prx/3207320715.prx>)

```
PROGRAM MAIN
VAR
(* EXAMPLE - BRIDGE between PIN 7 and 8 from X01 COM 2 Port*)
fb_COMPortOpen_1      : FB_COMPortOpen;
stCOMConfig_1         : ST_COMConfig;
hCOM                   : WORD;
Result_R               : INT;
Result_W               : INT;
Var_M                  : ARRAY[0..9] OF BYTE:=11,22,0,33,0(6);
Var_R                  : ARRAY[0..9] OF BYTE;
Value                  : INT;
Counter_V              : BYTE; (* It is all OK, this value counts up *)
i                       : INT;
i_k                    : INT;
fbTimer                : TON;
END_VAR
```

```
stCOMConfig_1.cbRxBufferLen :=300;
stCOMConfig_1.cbTxBufferLen :=300;
stCOMConfig_1.dwMode :=0;
stCOMConfig_1.BaudRate :=19200;
stCOMConfig_1.eCommPort :=COM2;
stCOMConfig_1.eDataBits:=EIGHT_DATABITS;
stCOMConfig_1.eParity:=EVEN;
stCOMConfig_1.eStoppBits:=ONE_STOPPBIT;

CASE i OF
(* Open Port *)
0: fb_COMPortOpen_1(bOpen:=TRUE , stCOMConfig:=stCOMConfig_1);
   IF NOT fb_COMPortOpen_1.bBusy THEN
     IF NOTfb_COMPortOpen_1.bError THEN
       hCOM:=fb_COMPortOpen_1.iHandle ;
       i:=i+1;
     ELSE
i:=100;
       END_IF
     END_IF
(* Write data*)
1: fbTimer(IN:=FALSE);
   Result_W:=F_COMPortWrite(hCom, 4,ADR(Var_M[0]));
   IF Result_W>0 THEN
     i:=i+1;
     Var_M[2]:=Var_M[2]+1;
   ELSE
     i:=101;
   END_IF
(*Receive data*)
2: Result_R:=F_COMPortRead(hCom, 100,ADR(Var_R[Value]));
   IF Result_R<>0 THEN
     Value:=Result_R+Value;
   END_IF
   IF Value>=4 THEN
     FOR i_k:=0 TO Value DO(*Check protocol*)
       IF Var_R[i_k-4]=11 AND Var_R[i_k-3]=22 AND Var_R[i_k-1]=33 THEN
         Counter_V:=Var_R[i_k-2];
         i:=1;
         Value:=0;
       END_IF
     END_FOR
   END_IF
   fbTimer(IN:=TRUE,PT:=t#1s); (*Watchdog receive*)
   IF fbTimer.Q THEN
     fbTimer(IN:=FALSE);
     i:=102;
   END_IF
100: ; (*ERROR open port*)
```

```
101: ; (*ERROR send data*)
102: i:=1; (*WD ERROR no data receive*)
END_CASE
```

5.13.2.7 BX debugging function

These functions can be used for measuring command execution times in a PLC project. The unit is a tick. One tick corresponds to 5.12 µs.

Start Debug Timer function

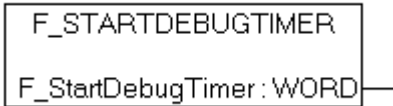

Fig. 95: Function block F_STARTDEBUGTIMER

Calling this function starts the timer. The return value is "0".

Read Debug Timer function

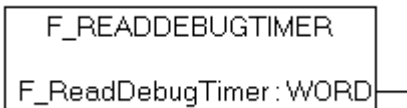

Fig. 96: Function block F_READDEDEBUGTIMER

This function reads the timer value. The return value has to be multiplied with 5.12 µs.

Example

```
VAR
    Timer_BX      :WORD;
    i              :INT;
END_VAR
```

Program

```
F_STARTDEBUGTIMER();
For i:=0 to 1000 do
;
END_FOR
Timer_BX:=F_READDEDEBUGTIMER();
```

5.13.2.8 Navigation switch

5.13.2.8.1 FUN GetNavSwitch

This function block enables reading of the navigation switch.

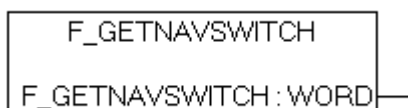

Fig. 97: Function block F_GETNAVSWITCH

VAR_Output

```
F_GETNAVSWITCH      :WORD;
```

Legend

F_GETNAVSWITCH: Switch data

WORD description

Bit	15	14	...	5	4	3	2	1	0
Name	LOCKED	-	...	-	PRESS	RIGHT	LEFT	DOWN	UP

If bit 15 is set, you are in the BX controller menu. This bit is set for as long as the user remains in the BX3100 menu. On exit of the menu, the navigation switch is immediately released for the PLC, i.e. pressing of the Press button is still visible in the program. Please take account of this in your application. For example, the switch should only be evaluated after a short delay by starting a timer with falling edge from bit 15.

 Download sample ST program <https://infosys.beckhoff.com/content/1033/bx5100/Resources/prx/3207322891.prx>

5.13.2.9 Display

5.13.2.9.1 FB DISPWRITE

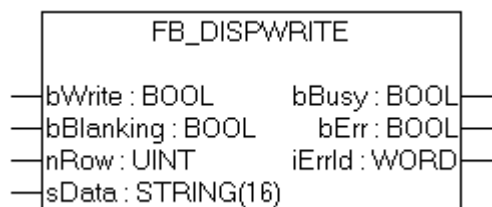

Fig. 98: Function block FB_DISPWRITE

VAR_INPUT

```
bWrite      :BOOL;
bBlanking  :BOOL;
nRow       :UINT;
sData      :STRING(16)
```

Legend

bWrite: rising edge starts the function block

bBlanking: FALSE backlight on, TRUE backlight off, default is on (supported in all BX controllers from FW 1.15).

nRow: row in display 1 or 2.

sData: displayed character string

VAR_OUTPUT

```
bBusy      :BOOL;
bErr       :BOOL;
iErrId     :WORD;
```

Legend

bBusy: The function block is active as long it is TRUE.

bErr: Error bit.

iErrId: Error number.

Return parameter	Meaning
0	No error
> 0	Error number

ST sample program

 Download <https://infosys.beckhoff.com/content/1033/bx5100/Resources/prx/3207325067.prx>

```
PROGRAM MAIN
VAR
    fb_DispWrite1: FB_DispWrite;
i:
    udiCounter:    UDINT;
    strCounter:    STRING;
    strLine:       STRING;
    k:             INT;
END_VAR

CASE i OF
0:  strCounter:=CONCAT('Counter ',UDINT_TO_STRING(udiCounter));
    fb_DispWrite1(bWrite:=TRUE , nRow:=1 , sData:=strCounter );
    IF NOT fb_DispWrite1.bBusy THEN
        IF NOTfb_DispWrite1.bErr THEN
            fb_DispWrite1(bWrite:=FALSE);
            udiCounter:=udiCounter+1;
            i:=1;
        END_IF
    END_IF
1:  fb_DispWrite1(bWrite:=TRUE , nRow:=2 , sData:=strLine);
    IF NOT fb_DispWrite1.bBusy THEN
        IF NOTfb_DispWrite1.bErr THEN
            fb_DispWrite1(bWrite:=FALSE);
            k:=k+1;
            strLine:=REPLACE(' ', '#',1,k);
            IF k=16 THEN
                k:=0;
            END_IF
            i:=0;
        END_IF
    END_IF
END_CASE
END_CASE
```

Display of ASCII table

Example for the "&" sign (see row 1 column 7): $00100110_{bin} = 38_{dec} = 26_{hex}$. In the PLC values this corresponds to '\$26' (string.)

<https://infosys.beckhoff.com/content/1033/bx5100/Resources/pdf/3207327243.pdf>

5.13.3 TcSystemBX

5.13.3.1 Real-time clock - example

The BX Controller features a real-time clock. The current time can be read via a function block. The following example will illustrate this.

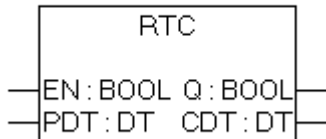

Fig. 99: Function block RTC

FUNCTION_BLOCK RTC**VAR_INPUT**

```
EN      :BOOL;
PDT     :DT;
```

Legend

EN: Rising edge sets the time to the value available at the PDT input.

PDT: Date and time to be set.

VAR_OUTPUT

```
Q       :BOOL;
CDT     :BOOL;
```

Legend

CDT: Current time.

Required libraries:

- TcSystemBX.lb6
- TcBaseBX.lb6



Download sample ST program (<https://infosys.beckhoff.com/content/1033/bx5100/Resources/prx/3207329419.prx>)

```
PROGRAM MAIN
VAR
    fbTimer: TON;
    fbRTC: RTC;
END_VAR
```

```
fbTimer (PT:=t#60s, IN:=NOT fbTimer.Q);
```

```
IF fbTimer.Q THEN
    fbRTC;
END_IF
```

**Do not call the RTC function block in every PLC cycle**

Calling the RTC block increases the cycle time by approx. 5 ms, due to the data conversion into a TIME AND DATE variable. The function block should therefore not be called during each PLC cycle. Alternatively, you can read the time via an [ADS function block](#). The ADS function block returns the date and the time as WORD variables.

Example 19:30 hrs - hour: 19 / minute: 30

5.13.3.2 Loading and storing of recipes

The function block fb_ReadWriteFile enables data (up to 16,000 bytes) to be stored permanently in the flash memory of the BX controller. A new program or a project reset does not affect the content of this memory. This function block is not suitable for sustained and continuous use. A maximum of 10000 write cycles are permitted. There is no limit on read operations.

Application: Saving of recipes or settings that only change rarely or not at all, for example controller parameters.

Note the following during writing of data



- The voltage must not be interrupted during writing. It is therefore advisable to initiate writing via an operating panel or the navigation keys or simply via a digital input, in order to ensure that the BX Controller is not switched off during writing. Automatic writing is not recommended, since uninterrupted voltage supply during writing cannot be guaranteed.
- Writing of data takes approx. two seconds, irrespective of the number of data that are written.
- The data are lost if the BX controller is switched off during the write operation.
- Only one instance of this function block is permitted.

Function block fb_ReadWriteFile

Function block for reading and writing of recipes

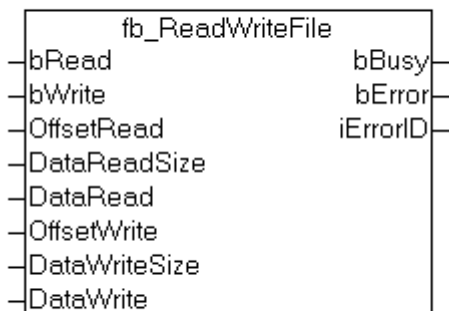

Fig. 100: Function block fb_ReadWriteFile

VAR_INPUT

```

bRead      :BOOL;
bWrite     :BOOL;
OffsetRead :WORD;
DataReadSize :WORD;
DataRead   :Pointer to Byte;
OffsetWrite :WORD;
DataWriteSize :WORD;
DataWrite  :Pointer to Byte;
    
```

Legend

- bRead*: A rising edge triggers reading of the function block (bWrite must be FALSE)
- bWrite*: A rising edge triggers writing of the function block (bRead must be FALSE)
- OffsetRead*: Offset in the memory 16,000 bytes max.
- DataReadSize*: Size of data to be read in bytes (16,000 bytes max.)
- DataRead*: The pointer should be pointed to the data via ADR
- OffsetWrite*: Offset in the memory 16,000 bytes max.
- DataWriteSize*: Size of data to be written in bytes (16,000 bytes max.)
- DataWrite*: The pointer should be pointed to the data via ADR

VAR_OUTPUT

```
bBusy      :BOOL;
bError     :BOOL;
bErrorId   :UDINT
```

Legend

bBusy: Indicates that the function block is still active

bError: Function block error

bErrorId: Error number

Return parameter iErrorId	Meaning
0	No error
1 _{dec}	READ: Data offset and data length more than 16,000 bytes
2 _{dec}	WRITE: Data offset and data length more than 16,000 bytes
0x31440708	CRC error in the data memory
0x31470708	Writing of data is not yet complete

Required libraries:

- TcSystemBX.lib6
- TcBaseBX.lib6

 Download sample ST program (<https://infosys.beckhoff.com/content/1033/bx5100/Resources/prx/3207331595.prx>)

5.13.4 TcComPortBX

5.13.4.1 TcComPortBX overview

Required libraries:

- TcBaseBX
- TcSystemBX

Overview

Name	Description
fb_BX_BK8x00_Master ▶ 113	BK8x00 COM port function block, communication with Bus Coupler BK8x00 or BC8x00
fb_BX_BK8x00_Slave ▶ 113	BK8x00 COM port function block, communication with PC. A BK8x00 is simulated.

Name	Description
FB_BX_COM_5 ▶ 116	Function block for emulating a KL60x1 (if COMlib.lib6 or ModbusRTU.lib6 is used).
FB_BX_COM_64 ▶ 117	Function block for emulating a PC interface (if COMlib.lib or ModbusRTU.lib is used).
FB_BX_COM_64ex ▶ 117	Function block for emulating a PC interface (if COMlib.lib or ModbusRTU.lib is used). Here the COM interface can be closed during operation.

5.13.4.2 BK8x00 - FB COM-Port

This function block can be used to connect (via the serial interface of the BXxxxx) the BK8000 serial Bus Coupler with RS485 and BK8100 with RS232 connection. The maximum baud rate is 38400 baud.

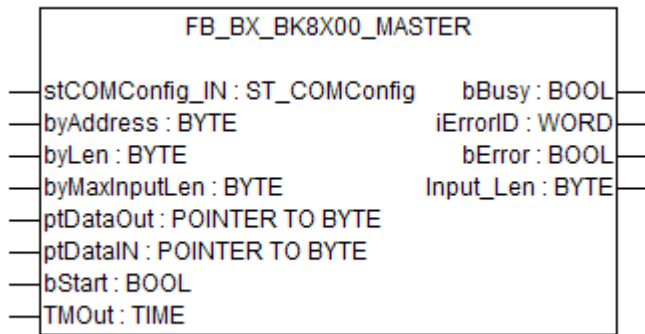

Fig. 101: Function block FB_BX_BK8X00_master

VAR_INPUT

```
stCOMConfig      :ST_COMConfig;
byAddress        :BYTE;
byLen            :BYTE;
byMaxInputLen   :BYTE;
ptDataOut       :POINTER TO BYTE;
ptDataIN        :POINTER TO BYTE;
bStart          :BOOL;
TmOut           :TIME;
```

Legend

stComConfig: Structure for selecting the COM parameters
 byAddress: BX8x00 address 1-98 (0 and 99 are reserved)
 byLen: data length in [BYTES] (only even numbers are permitted, i.e. 0, 2, 4, ...)
 byMaxInputLen: is connected with SIZEOF and the variable that is linked with ptDataIN
 ptDataOut: is connected with ADR and data out
 ptDataIn: is connected with ADR and data in
 bStart: rising edge starts the function block
 TMOut: delay until process is aborted

VAR_OUTPUT

```
bBusy           :BOOL;
bError          :BOOL;
iErrorId        :WORD;
Input_len       :WORD;
```

Legend

bBusy: The function block is active as long it is TRUE.
 bError: error bit
 iErrorID: Error number
 Input_Len: number of data that were received

Return parameter iErrorId	Meaning
0	No error
100 _{dec}	Error during opening of the COM port
101 _{dec}	Error during sending of data
102 _{dec}	Watchdog error, no response from the slave within the WD time
105 _{dec}	The input buffer is too small
200 _{dec}	CRC error
0x80xx _{hex}	Bus Coupler error xx status byte of the Bus Coupler (see BX8x00 documentation)

Hardware

RS 232 communication PIN assignment

BX COM1 RS232	BX COM2 RS232	BK8100
2	8	2
3	7	3
5	5	5

RS485 communication PIN assignment

FB settings: When using the RS485 connection it is important that the stCOMConfig variable is set to 1 and that the COM2 interface is selected.

BX COM2 RS485	BK8000
1	3
6	8

ST example program

 Download (<https://infosys.beckhoff.com/content/1033/bx5100/Resources/prx/3207333771.prx>)

Required material:

- BX3100 + Bus Terminal
- BK8100, KL1xx8, KL2xx8, KL9010
- Serial cable, PIN assignment: see sample program

5.13.4.3 BK8x00 - FB Slave COM-Port

With this function block, the PC (TwinCAT or KS8000) can be connected with the BXxxxx via the serial interface. The PC acts as the serial master, and the BXxxxx emulates a BK8x00 with the aid of the function block.

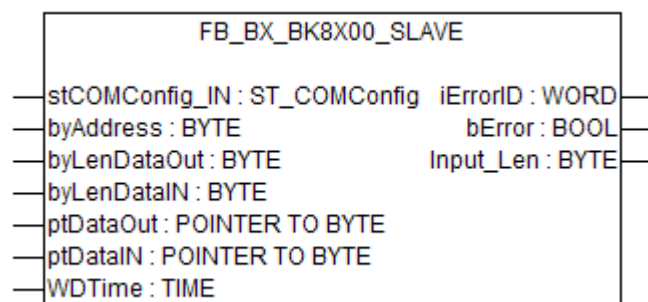

Fig. 102: Function block FB_BX_BK8X00_SLAVE

VAR_INPUT

```
stCOMConfig      :ST_COMConfig;
byAddress        :BYTE;
byLenDataOut     :BYTE;
byLenDataIN     :BYTE;
ptDataOut       :POINTER TO BYTE;
ptDataIN        :POINTER TO BYTE;
WDTime          :TIME;
```

Legend

stComConfig: Structure for selecting the COM parameters
 byAddress: BX8x00 address 1-98 (0 and 99 are reserved)
 byLenDataOut: data length in [BYTES] (only even numbers are permitted, i.e. 0, 2, 4, ...)
 byLenDataIn: data length in [BYTES] (only even numbers are permitted, i.e. 0, 2, 4, ...)
 ptDataOut: is connected with ADR and data out
 ptDataIn: is connected with ADR and data in
 WDTime: error message if no new data are received within the watchdog time (0 ms disable WD)

VAR_OUTPUT

```
bError          :BOOL;
iErrorId        :WORD;
Input_Len       :BYTE;
```

Legend

bError: error bit
iErrorId: Error number
Input_Len: number of data that were received

Return parameter iErrorId	Meaning
0	No error
1	Watchdog error, if greater than 0 ms (WD disable if 0 ms)
100 _{dec}	Error during opening of the COM port
101 _{dec}	Error during sending of data
103 _{dec}	Internal receive buffer overflow
104 _{dec}	Data exceed the PLC buffer capacity (more than 500 bytes)
105 _{dec}	Data cannot be copied into the PLC buffer
200 _{dec}	CRC error

Hardware

RS232 communication PIN assignment

BX COM 1 RS232	BX COM 2 RS232	PC COM interface
2	8	2
3	7	3
5	5	5

RS485 communication PIN assignment

FB settings: When using the RS485 connection it is important that the stCOMConfig variable is set to 1 and that the COM2 interface is selected.

BX COM 2 RS485	PC COM port (e.g. RS485 card W&T #13601, 2-wire, without echo, automatic)
1	1 - 2 bridges
6	6 - 7 bridges

ST sample program for BXxxx

 Download (<https://infosys.beckhoff.com/content/1033/bx5100/Resources/prx/3207335947.prx>)

System Manager file for TwinCAT as master. As shown in the figure, a Bus Coupler with Bus Terminals is configured. In this case, the type and number of Bus Terminals determines the data length. In principle, the type of Bus Terminal is irrelevant. Sample:

- 2 x KL3002 results in 4 words of input
- 2 x KL4002 results in 4 words of output

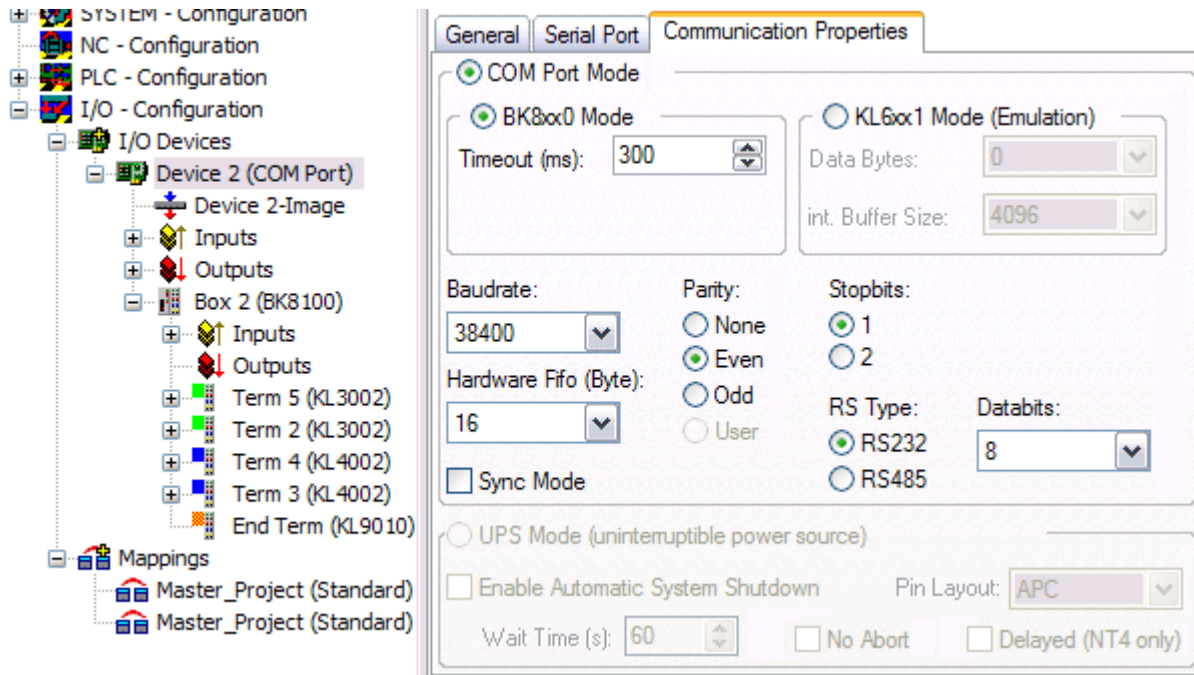

Fig. 103: Communication features

Required material:

- BX3100 + Bus Terminal
- PC with RS232 interface and TwinCAT from version 2.9, serial cable, PIN assignment: see above

5.13.4.4 FB_BX_COM_5

This function block connects ModbusRTU.lb6, ModbusRTU.lib or ComLib.lb6 with the serial interface of the BX Controller. It emulates a KL60x1 - data output is not via a Bus Terminal, but via one of the two serial interfaces of the BX.



Fig. 104: Function block FB_BX_COM_5

VAR_INPUT

```
pstrEma_IN      :POINTER TO BYTE;
pstrEma_OUT    :POINTER TO BYTE;
ComConfig      :ST_COMConfig;
```

Legend

pstrEmo_IN: Pointer to KL6inData5B
 pstrEmo_OUT: Pointer to KL6outData5B
 ComConfig [▶ 104]: Parameterization of the COM interface

 Download sample program in ST for linking COMLib and BX: (<https://infosys.beckhoff.com/content/1033/bx5100/Resources/prx/3207338123.prx>)

5.13.4.5 FB_BX_COM_64

This function block connects ModbusRTU.lib or ComLib.lib with the serial interface of the BX Controller. It emulates a PC interface. Data output is not via a PC interface, but via one of the two serial interfaces of the BX (COM1 or COM2).



Fig. 105: Function block FB_BX_COM_64

VAR_INPUT

```
pstrEmo_IN      :POINTER TO BYTE;
pstrEmo_OUT    :POINTER TO BYTE;
ComConfig      :ST_COMConfig;
```

Legend

pstrEmo_IN: Pointer to ModbusPCComInData
 pstrEmo_OUT: Pointer to ModbusPCComInData
 ComConfig [▶ 104]: Parameterization of the COM interface

 Download sample program in ST for linking ModbusRTU and BX: (<https://infosys.beckhoff.com/content/1033/bx5100/Resources/prx/3207340299.prx>)

 Download sample program in ST for linking ModbusRTU version 2 and BX: (<https://infosys.beckhoff.com/content/1033/bx5100/Resources/prx/3207342475.prx>)

The sample requires the ModbusRTU library!

5.13.4.6 FB_BX_COM_64ex

This function block connects ModbusRTU.lib or ComLib.lib with the serial interface of the BX Controller. A PC interface with 64 byte of user data is emulated. Data output is not via a PC interface, but via one of the two serial interfaces of the BX (COM1 or COM2).

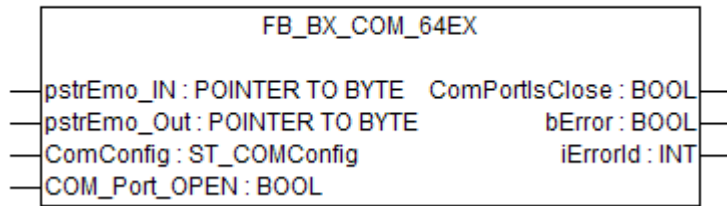

Fig. 106: Function block FB_BX_COM_64EX

VAR_INPUT

```
pstrEmo_IN      :POINTER TO BYTE;
pstrEmo_OUT     :POINTER TO BYTE;
ComConfig       :ST_COMConfig;
```

VAR_OUTPUT

```
ComPortIsClose  :BOOL;
bError          :BOOL;
iErrorId        :INT;
```

Legend**pstrEmo_IN:**

Pointer to ModbusPCComInData

pstrEmo_OUT:

Pointer to ModbusPCComOutData

ComConfig [▶ 104]:

Parameterization of the COM interface

COM_Port_Open:

If this bit is set, the interface is opened. If this bit is reset, the interface is closed.

ComPortIsClose:

If the interface is closed, this bit is set.

bError:

There is an error.

iErrorId:

Error code (see FB_COMPortOpen) [▶ 103]

 Download sample program in ST for linking ModbusRTU and BX: (<https://infosys.beckhoff.com/content/1033/bx5100/Resources/prx/3207344651.prx>)

The sample requires the ModbusRTU library!

5.13.4.7 Further samples**5.13.4.7.1 BX COM port as ModbusRTU master**

The serial interface of the BX can also be used as Modbus master.

Necessary components

```
1 x BX3100
Bus Terminals for the K-Bus (any, since they are not used for the example)
1 x BK7300
2 x KL2xx4
2 x KL1xx4
1 x KL9010
```

RS 485 cable*

BX3100 COM 2 / RS 485	BK7300 / RS 485
1	3
6	8

*) active termination resistor required for short cable lengths (< 5 m) and low baud rates (<19200 baud)

 **Download ST sample program for linking the ModbusRTU master and BX:** (<https://infosys.beckhoff.com/content/1033/bx5100/Resources/prx/3207346827.prx>)

 **Download ST sample program for linking the ModbusRTU master version 2 and BX:** (<https://infosys.beckhoff.com/content/1033/bx5100/Resources/prx/3207349003.prx>)

The example requires the ModbusRTU, TcComPortBC, TcBaseBX libraries.
 Baud rate 9600, n, 8.1 default BK7300,
 BK7300 address 11

Reaction times

The reaction times depend on the set task time, the number of slaves, the length of the Modbus telegrams and the response time of the slaves.
 Beckhoff BK7300 Modbus slaves were used for determining the following table. Since this is not transferable to all slaves, the table should only be used for guidance.

Baud rate 38400 baud (one read reg. and one write reg. telegram per slave)

Number of slaves	Task time on the BX	Time for one cycle
1	5	100 ms* / 125 ms**
2	5	200 ms / 225 ms
1	10	180 ms / 220 ms
2	10	350 ms / 390 ms
1	20	350 ms / 350 ms
2	20	700 ms / 700 ms

*) 2 words inputs and 2 words outputs
 *) 20 words inputs and 20 words outputs

5.13.4.7.2 BX COM port - ComLibV2

Examples for ComLibV2 sending of strings via the internal COM interface of the BX controller. For receiving a bridge can be established from PIN 7 and 8 to X01 (COM2).

Required material

Hardware:

- BX Controller

Software:

- TwinCAT from 2.10
- COMlibV2.lib
- TcComPortBX.lbx
- Standard.lbx
- TcBase.lbx
- TcSystemBX.lbx

 Download BX sample program: (<https://infosys.beckhoff.com/content/1033/bx5100/Resources/prx/3207351179.prx>)

5.13.4.7.3 BX COM port - Cimrex panel

The serial interface of the BX controller can also be used as Modbus slave. In this example, a panel from the company Beijers is connected. Further information on the panel can be found under <http://www.beijerelectronics.de>.



Fig. 107: Cimrex panel at the COM port of the BX controller

Necessary components

- 1 x BX3100
- 1 x Cimrex 12
- any Bus Terminals (any, since no Bus Terminals are used in the example)

RS232 cable

BX3100 COM 2 / RS485	Cimrex 12 RS232
7	2
8	3
9	5

RS485* cable

BX3100 COM 2 / RS 485	Cimrex 12 RS485
1	2 -3
6	15 -16

*) active termination resistor is not required for short cable lengths (≤ 5 m) and low baud rates (≤ 19200 baud)

 Download sample program in ST for the BX: (<https://infosys.beckhoff.com/content/1033/bx5100/Resources/prx/3207340299.prx>)

 Download sample with Cimrex panel: (<https://infosys.beckhoff.com/content/1033/bx5100/Resources/cpa/3207353355.cpa>)

The example requires the ModbusRTU, TcComPortBC and TcBaseBX libraries.

- Baud rate 9600,n,8,1 D
- Cimrex 12

5.13.4.7.4 BX COM port - RK512 protocol

The RK512 protocol can exchange data with a distant station via the COM1 or COM2 interface of the BX controller. Documentation for the RK512 function block can be found in the Beckhoff Information System. The serial PC interface is simulated via the 64 byte emulation of the BX controller.

Required material

Hardware:

- PC with RS232 interface and TwinCAT PLC from 2.9
- BX Controller
- Serial cable for the BX - PC connection

Software:

- TwinCAT from 2.9
- COMlib.lib
- COMlib3964R.lib
- COMlibRK512.lib
- TcComPortBX.lbx
- Standard.lbx
- TcBase.lbx
- TcSystemBX.lbx
- ChrAscBx.lbx

 Download sample program BX3100: (<https://infosys.beckhoff.com/content/1033/bx5100/Resources/prx/3207355531.prx>)

 Download PC sample program: (<https://infosys.beckhoff.com/content/1033/bx5100/Resources/pro/3207357707.pro>)

 Download sample System Manager file PC: (<https://infosys.beckhoff.com/content/1033/bx5100/Resources/tsm/3207359883.tsm>)

5.13.4.7.5 BX COM port - text message via mobile phone

The serial interface can also be used for sending a text message from the BX controller. The following example uses the SMS library with a Siemens S35 mobile phone.

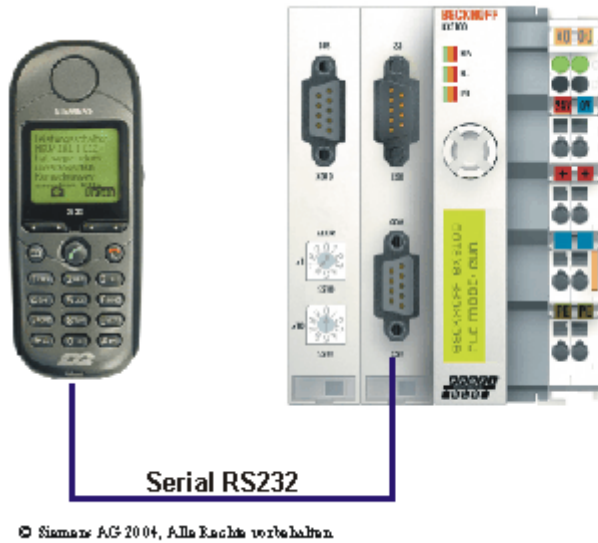

Fig. 108: Mobile phone at the COM port of the BX controller

 Download: (<https://infosys.beckhoff.com/content/1033/bx5100/Resources/prx/3207362059.prx>)

Pin assignment (Siemens cable S30880-S4501 A801-2)

S35	COM 1	COM 2
2	3	7
3	2	8
5	5	9

5.13.5 TcTwinSAFE

5.13.5.1 Overview

The Bus Terminal Controllers of the BX series support the TwinSAFE Bus Terminals when the following conditions are met:

- At the Bus Terminal Controller only one logic terminal is permitted. It must be connected to the K-bus interface, not the SSB.
- At this logic terminal a maximum of seven connections are permitted.
- TwinSAFE-input and output terminals can be connected to the K-bus or the SSB, for example via BK5120 or BK515x.
- If the online change feature is to be used, the connection timeout must be set to 500 ms or greater.
- An ADS connection must exist for downloading the TwinSAFE projects. The connection can be serial or via the fieldbus.
- The firmware version of the Bus Terminal Controller must be 1.17 or higher.

TwinSAFE library

The TwinSAFE library includes function blocks for executing services/functions in connection with the TwinSAFE terminals KL1904, KL2904 and KL6904.

Name	Description
F_GetVersionTcTwinSAFE [▶ 123]	Library version number
FB_TwinSAFE_KLx904_input [▶ 123]	Evaluation of TwinSAFE data sent from a KL1904 or KL2904 to a KL6904
FB_TwinSAFE_KLx904_output [▶ 126]	Evaluation of TwinSAFE data sent from a KL6904 to a KL1904 or KL2904

 Download of the TwinSAFE library: (<https://infosys.beckhoff.com/content/1033/bx5100/Resources/lbx/3207364235.lbx>)

5.13.5.2 FUNCTION F_GetVersionTcTwinSAFE

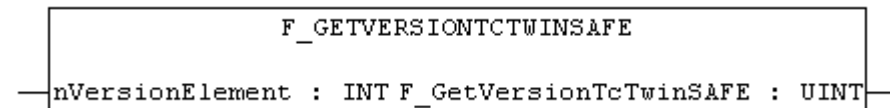

Fig. 109: Function block F_GETVERSIONTCTWINSAFE

This function can be used to read PLC library version information.

FUNCTION F_GetVersionTcTwinSAFE : UINT

```
VAR_INPUT
    nVersionElement : INT;
END_VAR
```

nVersionElement: Version element to be read. Possible parameters:

- 1 : major number;
- 2 : minor number;
- 3 : revision number;

Development environment	Target platform	IO Hardware	PLC libraries to include
TwinCAT v2.10.0 Build > 914	PC (i386)	-	TcTwinSAFE.Lib (Standard.lib, TcBase.Lib and TcSystem.Lib are integrated automatically)
TwinCAT v2.10.0	BX series	-	TcTwinSAFE.LBX (Standard.LBX; TcBaseBX.LBX; TcSystemBX.LBX are integrated automatically)

5.13.5.3 FUNCTION_BLOCK FB_TwinSAFE_KLx904_input

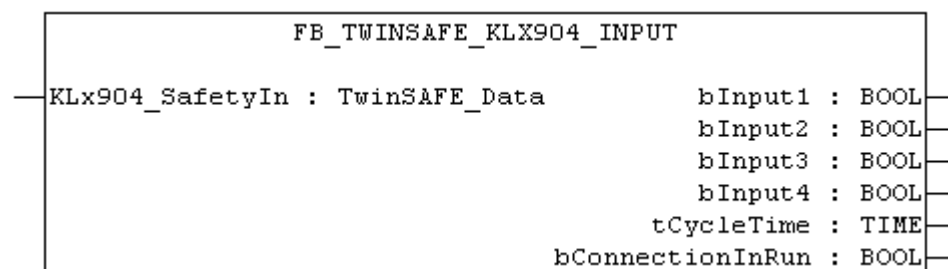

Fig. 110: Function block FB_TWINSAFE_KLX904_INPUT

The function block *FB_TwinSAFE_KLx904_input* can be used for evaluation of TwinSAFE data sent from a KL1904 or KL2904 to a KL6904. The input parameter is doubly linked to the SafetyIn data of a KL1904 or KL2904 in the System Manager.

VAR_INPUT

```
VAR_INPUT
    KLx904_SafetyIn AT%I* : TwinSAFE_Data; (* Additional link to "SafetyIn" *)
END_VAR
```

KLx904_SafetyIn: TwinSAFE telegram sent from a KL1904 or KL2904 to a KL6904. This parameter is doubly linked to SafetyIn in the System Manager (input data of the KLx904).

VAR_OUTPUT

```
VAR_OUTPUT
    bInput1          : BOOL;
    bInput2          : BOOL;
    bInput3          : BOOL;
    bInput4          : BOOL;
    tCycleTime       : TIME;
    bConnectionInRun : BOOL;
END_VAR
```

bInput1: Returns input 1 of a KL1904. If this function block is used for connection to a KL2904, the value is always 0.

bInput2: Returns input 2 of a KL1904. If this function block is used for connection to a KL2904, the value is always 0.

bInput3: Returns input 3 of a KL1904. If this function block is used for connection to a KL2904, the value is always 0.

bInput4: Returns input 4 of a KL1904. If this function block is used for connection to a KL2904, the value is always 0.

tCycleTime: Returns the cycle time in ms for exchanging the TwinSAFE telegram between the devices.

bConnectionInRun: Returns TRUE if there is no error in the connection between the KLx904 and the KL6904.

Example of a call in the FBD:

```
PROGRAM MAIN
VAR
    fbTwinSAFE_KLx904_input : FB_TwinSAFE_KLx904_input;
    bInput1_KL1904_S_Address_113 : BOOL;
    bInput2_KL1904_S_Address_113 : BOOL;
    bInput3_KL1904_S_Address_113 : BOOL;
    bInput4_KL1904_S_Address_113 : BOOL;
    tCycleTime_KL1904_KL6904 : TIME;
    bConnection3_In_Run : BOOL;
END_VAR
```

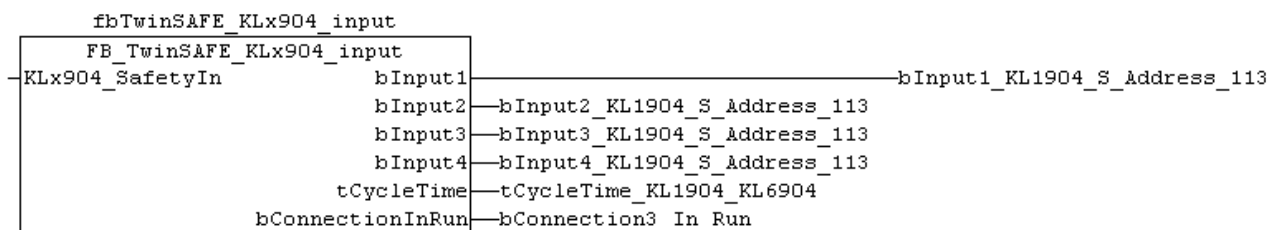

Fig. 111: Function block FB_TWINSAFE_KLX904_input

In the example the values of the KL1904 input data are written to the connected variables. If the output bConnectionInRun is FALSE, all outputs are set to FALSE.

To link the input data, select the parameter KLx904_SafetyIn and select "Modify link..." from the context menu.

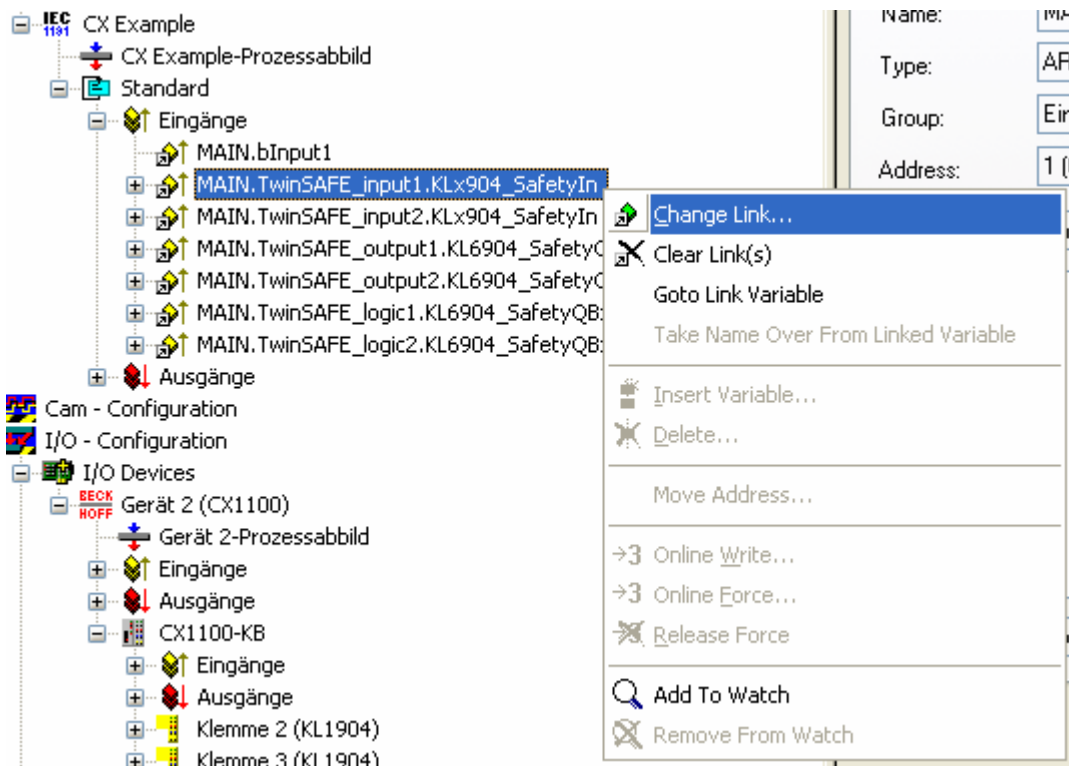

Fig. 112: Linking the input data

and select the corresponding SafetyIn variable in the dialog that follows.

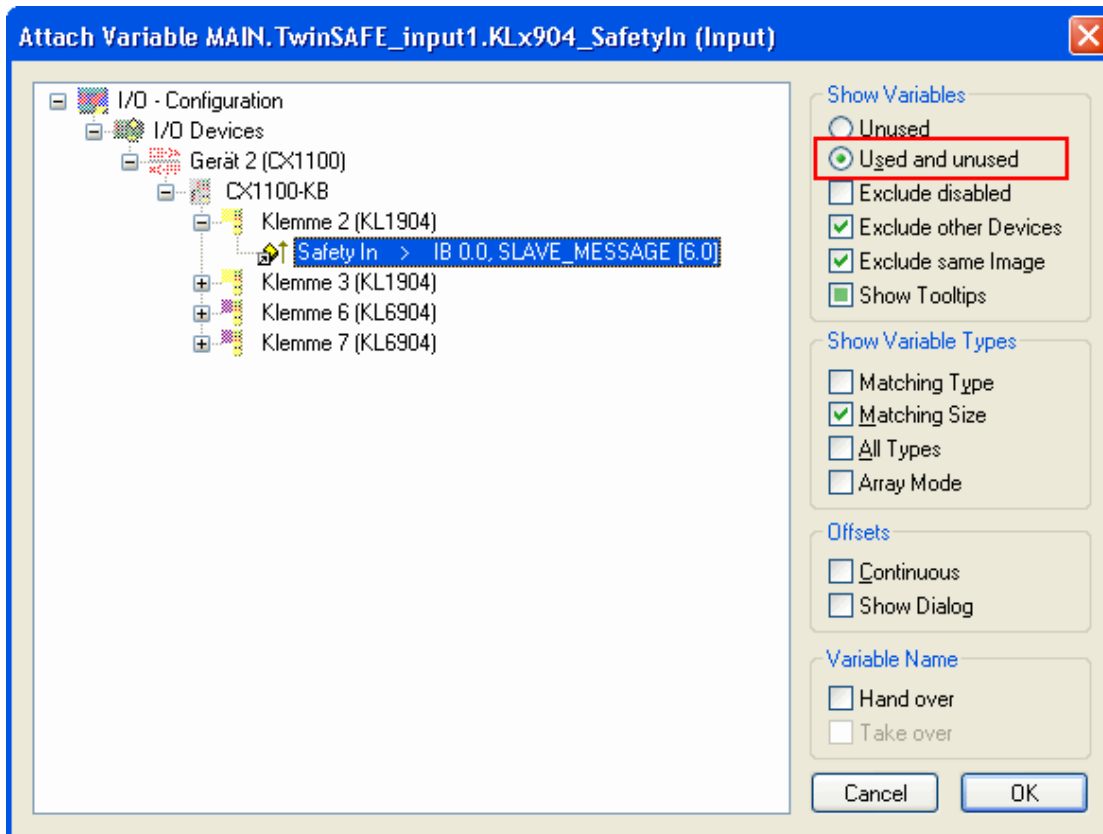

Fig. 113: Selecting the SafetyIn variable

Development environment	Target platform	IO Hardware	PLC libraries to include
TwinCAT v2.10.0 Build > 914	PC (i386)	KLx904	TcTwinSAFE.Lib (Standard.lib, TcBase.Lib and TcSystem.Lib are integrated automatically)
TwinCAT v2.10.0 Build > 914	BX series	KLx904	TcTwinSAFE.LBX (Standard.LBX, TcBaseBX.LBX and TcSystemBX.LBX are integrated automatically)

5.13.5.4 FUNCTION_BLOCK FB_TwinSAFE_KLx904_output

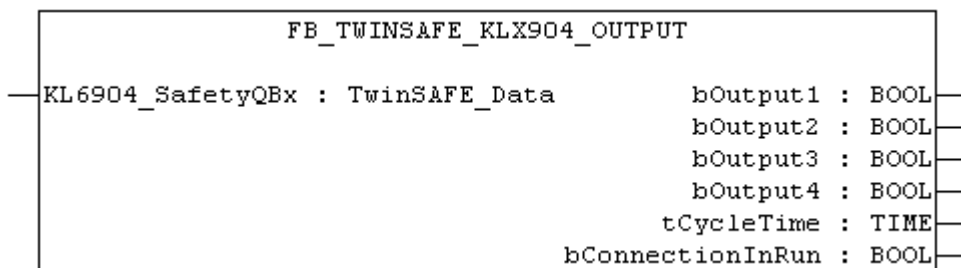

Fig. 114: Function block FB_TWINSAFE_KLX904_output

The function block *FB_TwinSAFE_KLx904_output* can be used for evaluation of TwinSAFE data sent from a KL6904 to a KL1904 or KL2904. The input parameter is doubly linked to the SafetyQBx data of a KL6904 in the System Manager.

VAR_INPUT

```

VAR_INPUT
    KL6904_SafetyQBx AT%I* : TwinSAFE_Data; (* Additional link to "SafetyQBx" *)
END_VAR

```

KL6904_SafetyQBx: TwinSAFE telegram sent from a KL6904 to a KL1904 or KL2904. This parameter is doubly linked to SafetyQBx in the System Manager (input data of the KL6904); x represents for numerals between 1 and 15, according to the TwinSAFE connection used.

VAR_OUTPUT

```

VAR_OUTPUT
    bOutput1      : BOOL;
    bOutput2      : BOOL;
    bOutput3      : BOOL;
    bOutput4      : BOOL;
    tCycleTime    : TIME;
    bConnectionInRun : BOOL;
END_VAR

```

bOutput1: Returns output 1 of a KL2904. If the function block is used for a connection to the KL1904, this value is always 0.

bOutput2: Returns output 2 of a KL2904. If the function block is used for a connection to the KL1904, this value is always 0.

bOutput3: Returns output 3 of a KL2904. If the function block is used for a connection to the KL1904, this value is always 0.

bOutput4: Returns output 4 of a KL2904. If the function block is used for a connection to the KL1904, this value is always 0.

tCycleTime: Returns the cycle time in ms for exchanging the TwinSAFE telegram between the devices.

bConnectionInRun: Returns TRUE if there is no error in the connection between the KL6904 and the KLx904.

Example of a call in the FBD

```
PROGRAM MAIN
VAR
  fbTwinSAFE_KLx904_output      : FB_TwinSAFE_KLx904_output;
  bOutput1_KL6904_Connection_to_113 : BOOL;
  bOutput2_KL6904_Connection_to_113 : BOOL;
  bOutput3_KL6904_Connection_to_113 : BOOL;
  bOutput4_KL6904_Connection_to_113 : BOOL;
  tCycleTime_KL6904_KL1904       : TIME;
  bConnection3_In_Run_2         : BOOL;
END_VAR
```

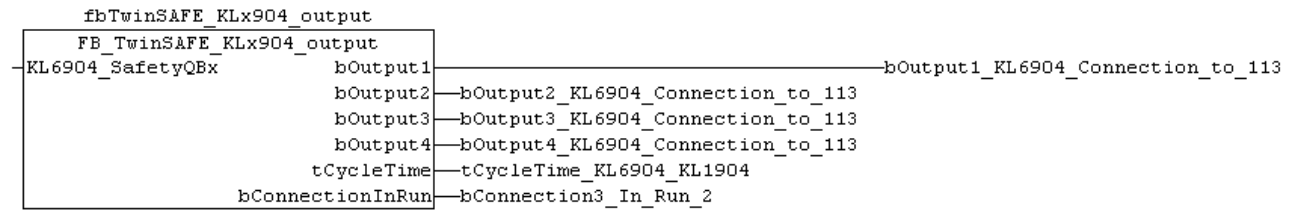

Fig. 115: Call of function block FB_TWINSAFE_KLX904_OUTPUT

In the example the values of TwinSAFE terminals KL6904 and KL1904 are evaluated. Since no output signals are used in this connection, the outputs are always FALSE. Only tCycleTime and bConnectionInRun can be evaluated.

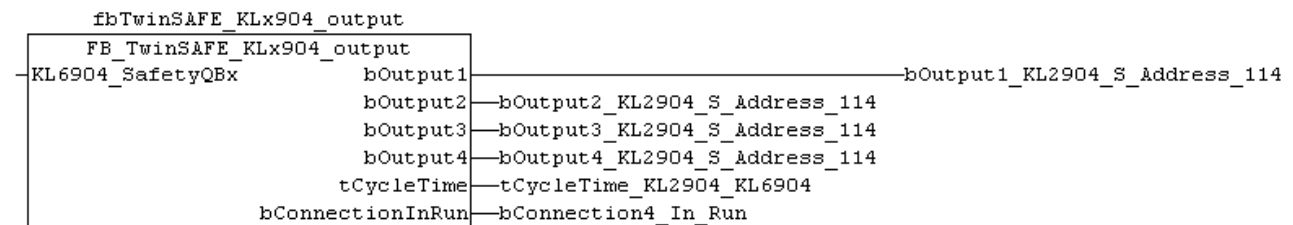

Fig. 116: Call of function block FB_TWINSAFE_KLX904_OUTPUT

In the example the values of TwinSAFE terminals KL6904 and KL1904 are evaluated. In this connection the output signals are written to the KL2904 and copied from the function block to the connected variables. If the output bConnectionInRun is FALSE, all outputs are set to FALSE.

To link the input data, select the parameter KL6904_SafetyQBx and select "Modify link..." from the context menu.

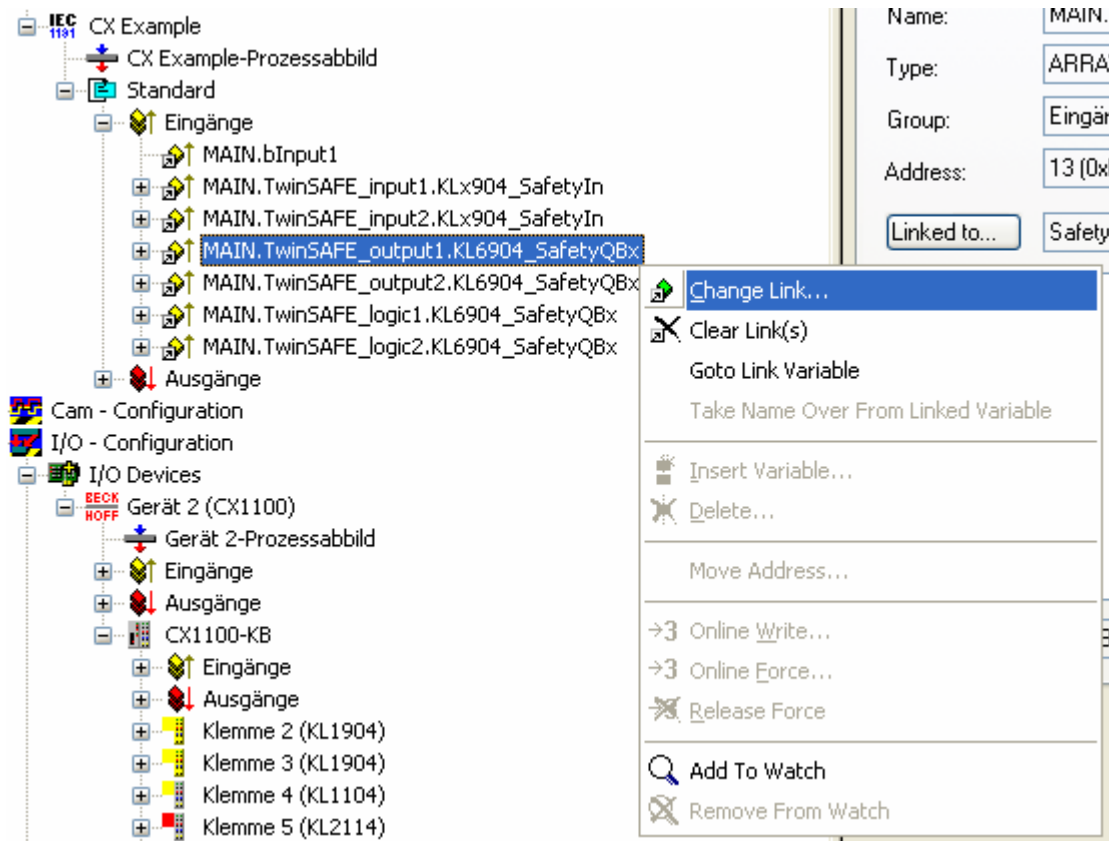

Fig. 117: Linking the input data

and select the corresponding SafetyQBx variable in the dialog that follows.

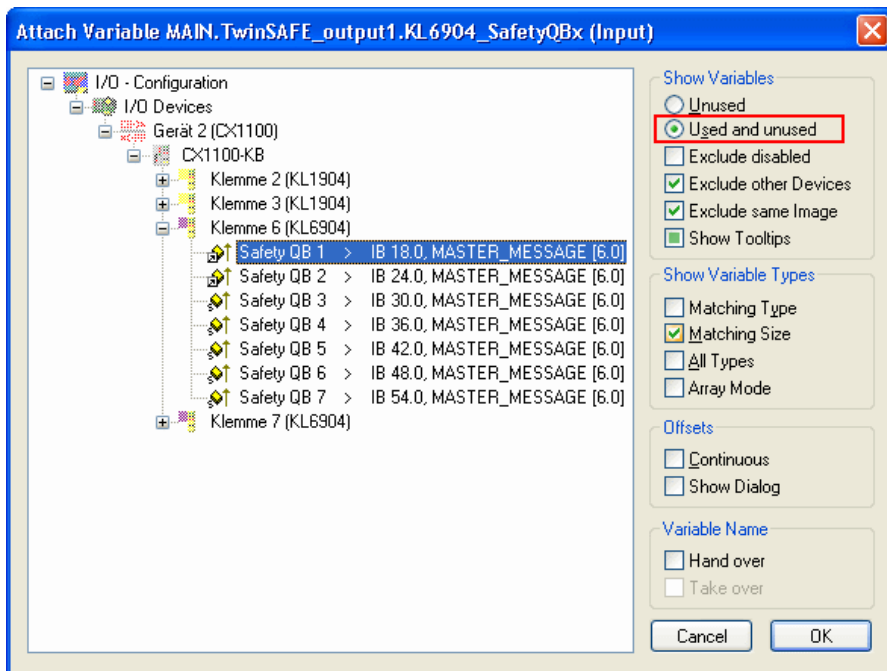

Fig. 118: Selecting the corresponding SafetyQBx variable

Development environment	Target platform	IO Hardware	PLC libraries to include
TwinCAT v2.10.0 Build > 914	PC (i386)	KLx904	TcTwinSAFE.Lib (Standard.lib, TcBase.Lib and TcSystem.Lib are integrated automatically)
TwinCAT v2.10.0 Build > 914	BX series	KLx904	TcTwinSAFE.LBX (Standard.LBX, TcBaseBX.LBX and TcSystemBX.LBX are integrated automatically)

5.14 Program transfer

5.14.1 Program transfer via the serial interface

Every Bus Terminal Controller can be programmed via the PC's RS232 interface.

Select the serial interface in TwinCAT PLC Control.

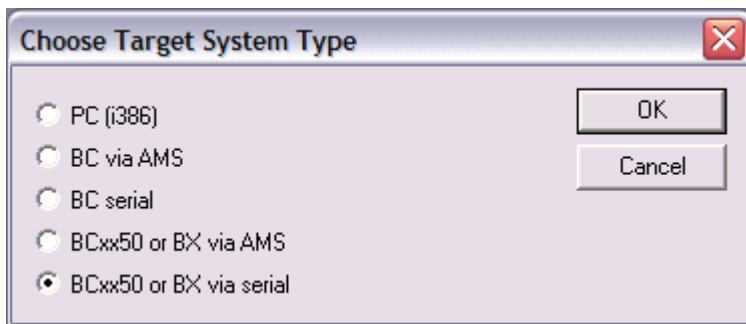

Fig. 119: Selecting the data transfer route - serial interface

The settings for the serial interface, port number, baud rate etc. are found under Online/Communication parameters in PLC Control.

The Bus Terminal Controller requires the following setting:

- Baud Rate: 9600/19200/38400/57600 baud (automatic baud rate detection)
- Stop bits: 1
- Parity: Straight line

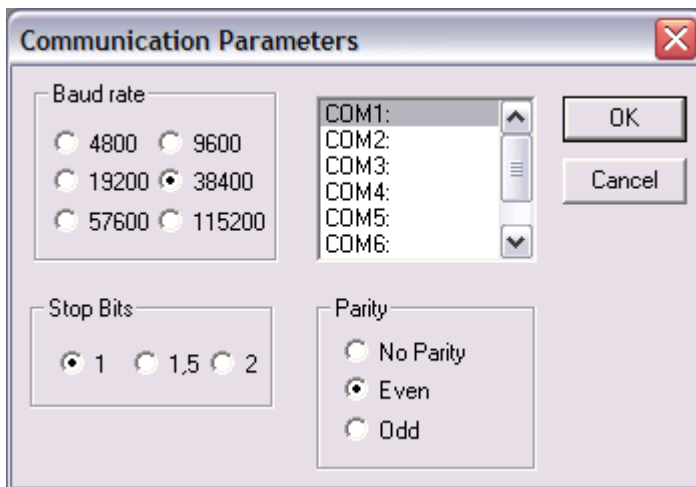

Fig. 120: Parameterization of the serial interface

Program transfer via the serial interface and ADS

The Bus Terminal Controller can be programmed via the PC's RS232 interface. Before you can work with the Bus Terminal Controller, TwinCAT must be notified of it (see serial ADS [▶ 43]).

Select the ADS connection in TwinCAT PLC Control.

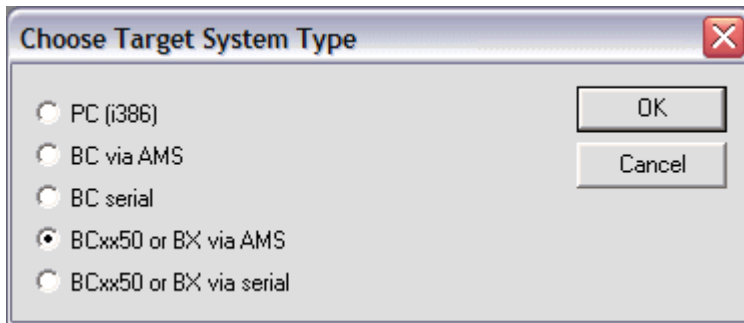

Fig. 121: Selecting the data transfer route - AMS

PLC Control can be accessed via *Online/Communication Parameters...*

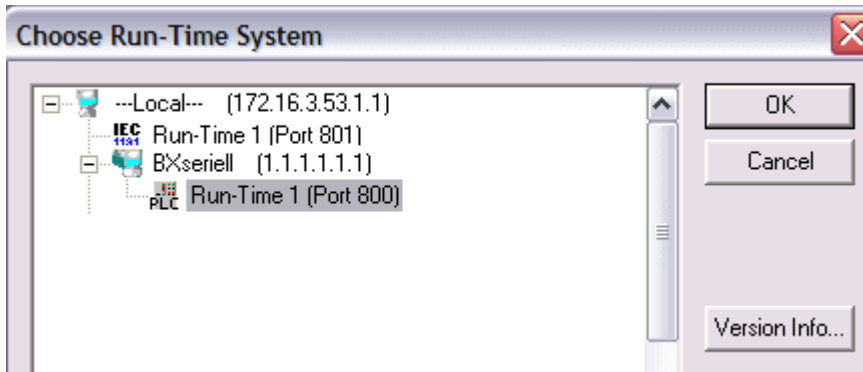

Fig. 122: Selecting the device

5.14.2 Programming via CANopen

TwinCAT offers the option to transfer the user program to the Bus Terminal Controller via the fieldbus. The BC/BX can be selected as the target system in PLC Control, after saving in the registry and restarting the TwinCAT system. The TwinCAT-level TwinCAT PLC is necessary.

Minimum requirements

FC510x with firmware from 1.55
TwinCAT 2.9 Build 948

Initializing the Bus Terminal Controller

The coupler must first be made known to the system before it can be selected in PLC Control. Enter the Bus Terminal Controller in the System Manager, specify type, quantity and size of the fieldbus variables and link them with a task. For the subsequent program download via CANopen, the ADS interface must be enabled for the Bus Terminal Controller in the ADS tab. Save your settings and activate the configuration. Then start the TwinCAT system and the cyclic task.

TwinCAT System Manager

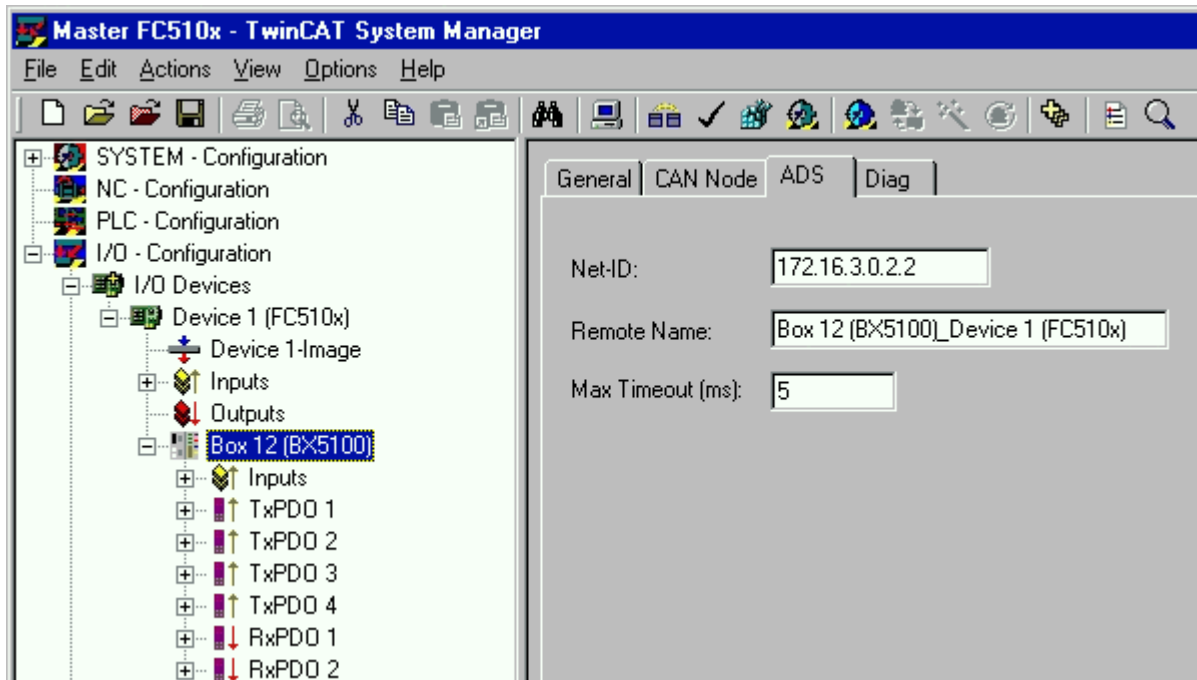

Fig. 123: Display of the BX5100 in the TwinCAT System Manager

PLC Control

When TwinCAT PLC Control is restarted, TwinCAT asks for the target platform, i.e. the device on which the user program is later to run. TwinCAT offers two target platforms as controller, the PC or the Bus Terminal Controller.

Two options are available to you for transmission to the Bus Terminal Controller:

- AMS for BCxx00 (Bus Terminal Controller without online change, one task)
- AMS for BCxx50 and BX (Bus Terminal Controller with online change, two tasks)
- BC serial – the serial cable for communication via the RS232 interface of the PC and the programming interface of the Bus Terminal Controller

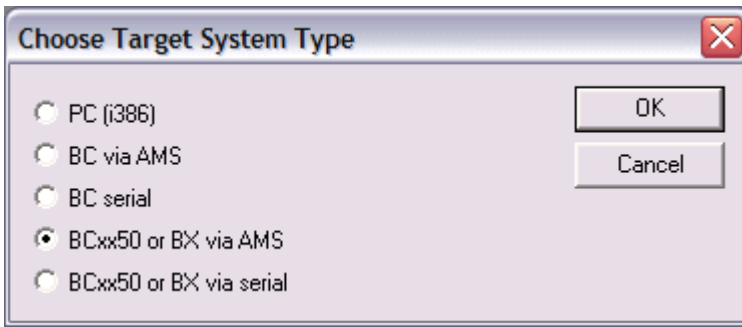

Fig. 124: Choose Target System

After your program has been created, select the target system under the *Online* toolbar. TwinCAT must be running to do this. In the sample, this is the Ethernet card with Box 2 and the Run-Time 1 of the Bus Terminal Controller.

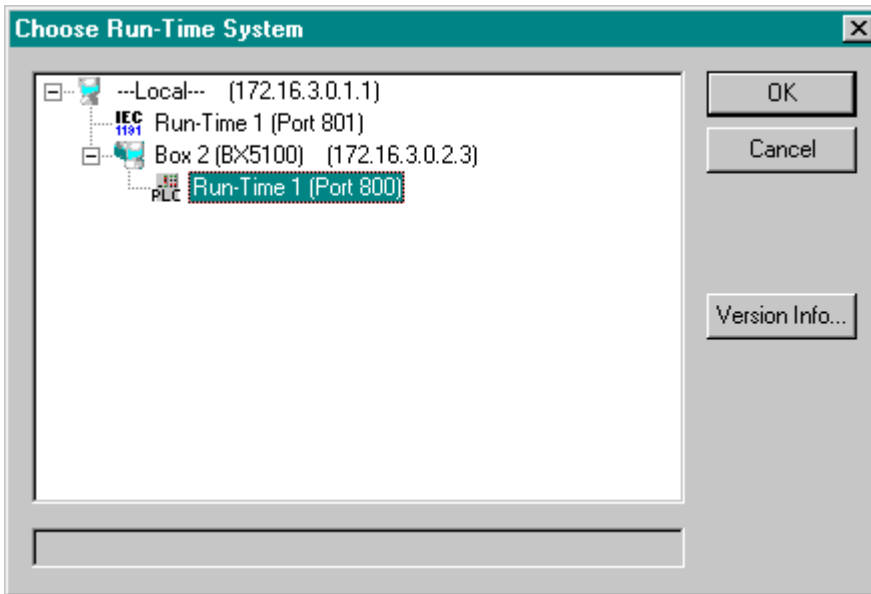

Fig. 125: Selecting the target system - box 2, runtime 1 of the Bus Terminal Controller

6 CANopen Communication

6.1 CANopen Introduction



Fig. 126: CANopenLogo

CANopen is a widely used CAN application layer, developed by the CAN-in-Automation association (CiA, <http://www.can-cia.org>), and which has meanwhile been adopted for international standardization.

Device Model

CANopen consists of the protocol definitions (communication profile) and of the device profiles that standardize the data contents for the various device classes. Process data objects (PDO) [► 139] are used for fast communication of input and output data. The CANopen device parameters and process data are stored in a structured object directory. Any data in this object directory is accessed via service data objects (SDO). There are, additionally, a few special objects (such as telegram types) for network management (NMT), synchronization, error messages and so on.

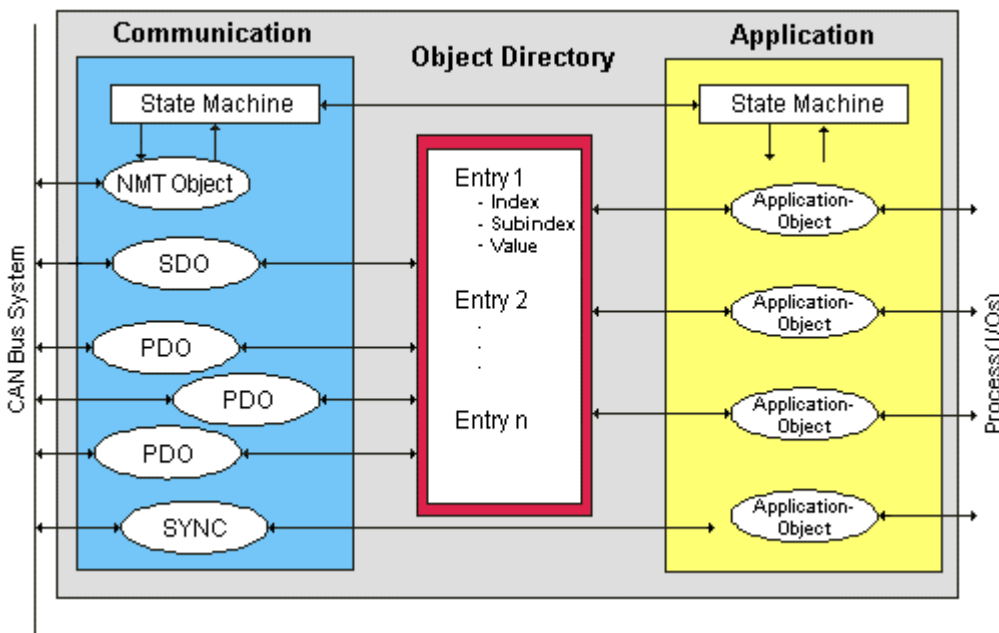

Fig. 127: CANopen Device Model

Communication Types

CANopen defines a number of communication classes for the input and output data (process data objects):

- Event driven [► 141]: Telegrams are sent as soon as their contents have changed. This means that the process image as a whole is not continuously transmitted, only its changes.
- Cyclic synchronous [► 141]: A SYNC telegram causes the modules to accept the output data that was previously received, and to send new input data.
- Requested (polled) [► 139]: A CAN data request telegram causes the modules to send their input data.

The desired communication type is set by the Transmission Type [► 139] parameter.

Device Profile

The BECKHOFF CANopen devices support all types of I/O communication, and correspond to the device profile for digital and analog input/output modules (DS401 Version 1). For reasons of backwards compatibility, the default mapping was not adapted to the DS401 V2 profile version.

Data transfer rates

Nine transmission rates from 10 kbaud up to 1 Mbaud are available for different bus lengths. The effective utilization of the bus bandwidth allows CANopen to achieve short system reaction times at relatively low data rates.

Topology

CAN is based on a linear [topology](#) [► 26]. The number of devices participating in each network is logically limited by CANopen to 128, but physically the present generation of drivers allows up to 64 nodes in one network segment. The maximum possible size of the network for any particular data rate is limited by the signal propagation delay required on the bus medium. For 1 Mbaud, for instance, the network may extend 25 m, whereas at 50 kbaud the network may reach up to 1000 m. At low data rates the size of the network can be increased by repeaters, which also allow the construction of tree structures.

Bus access procedures

CAN utilizes the Carrier Sense Multiple Access (CSMA) procedure, i.e. all participating devices have the same right of access to the bus and may access it as soon as it is free (multi-master bus access). The exchange of messages is thus not device-oriented but message-oriented. This means that every message is unambiguously marked with a prioritized identifier. In order to avoid collisions on the bus when messages are sent by different devices, a bit-wise bus arbitration is carried out at the start of the data transmission. The bus arbitration assigns bus bandwidth to the messages in the sequence of their priority. At the end of the arbitration phase only one bus device occupies the bus, collisions are avoided and the bandwidth is optimally exploited.

Configuration and parameterization

The TwinCAT System Manager allows all the CANopen parameters to be set conveniently. An "eds" file (an electronic data sheet) is available on the Beckhoff website (<http://www.beckhoff.de>) for the parameterization of Beckhoff CANopen devices using configuration tools from other manufacturers.

Certification

The Beckhoff CANopen devices have a powerful implementation of the protocol, and are certified by the CAN in Automation Association (<http://www.can-cia.org>).

6.2 Protocol Description

6.2.1 Network Management

Simple Boot-Up

CANopen allows the distributed network to boot in a very simple way. After initialization, the modules are automatically in the *Pre-Operational* state. In this state it is already possible to access the object directory using service data objects (SDOs) with default identifiers, so that the modules can be configured. Since default settings exist for all the entries in the object directory, it is in most cases possible to omit any explicit configuration.

Only one CAN message is then required to start the module: Start_Remote_Node: Identifier 0, two data bytes: 0x01, 0x00. It switches the node into the *Operational* state.

Network Status

The states and the state transitions involved as CANopen boots up can be seen from the state diagram:

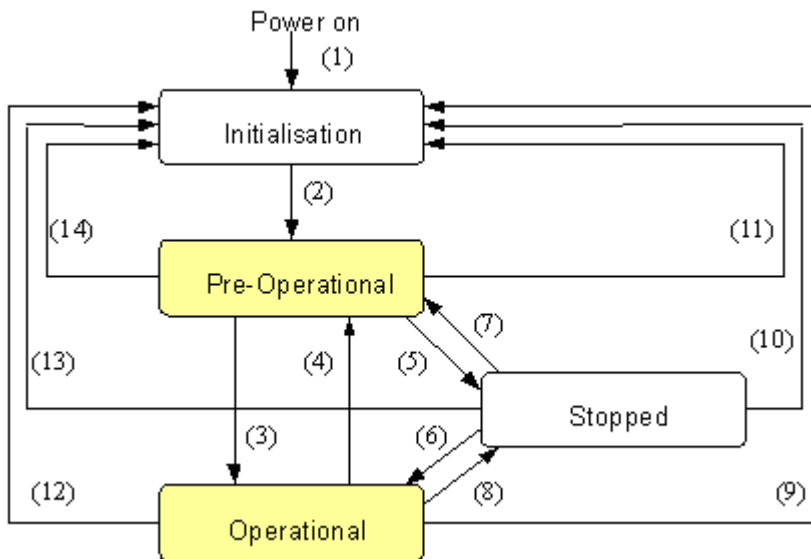

Fig. 128: CANopen bootup state diagram

Pre-Operational

After initialization the Bus Coupler goes automatically (i.e. without the need for any external command) into the *Pre-Operational* state. In this state it can be configured, since the service data objects (SDOs) are already active. The process data objects, on the other hand, are still locked.

Operational

In the *Operational* state the process data objects are also active.

If external influences (such as a CAN error, or absence of output voltage) or internal influences (such as a K-Bus error) mean that it is no longer possible for the Bus Coupler to set outputs, to read inputs or to communicate, it attempts to send an appropriate emergency message, goes into the error state, and thus returns to the *Pre-Operational* state. In this way the NMT status machine in the network master can also immediately detect fatal errors.

Stopped

In the *Stopped* state (formerly: *Prepared*) data communication with the Coupler is no longer possible - only NMT messages are received. The outputs go into the fault state.

State Transitions

The network management messages have a very simple structure: CAN identifier 0, with two bytes of data content. The first data byte contains what is known as the command specifier (cs), and the second data byte contains the node address, the node address 0 applying to all nodes (broadcast).

11 bit identifier	2 byte user data						
0x00	cs	Node ID					

The following table gives an overview of all the CANopen state transitions and the associated commands (command specifier in the NMT master telegram):

Status transition	Command Specifier cs	Explanation
(1)	-	The initialization state is reached automatically at power-up
(2)	-	After initialization the pre-operational state is reached automatically - this involves sending the boot-up message.
(3), (6)	cs = 1 = 0x01	Start_Remote_Node. Starts the module, enables outputs, starts transmission of PDOs.
(4), (7)	cs = 128 = 0x80	Enter_Pre-Operational. Stops PDO transmission, SDO still active.
(5), (8)	cs = 2 = 0x02	Stop_Remote_Node. Outputs go into the fault state, SDO and PDO switched off.
(9), (10), (11)	cs = 129 = 0x81	Reset_Node. Carries out a reset. All objects are reset to their power-on defaults.
(12), (13), (14)	cs = 130 = 0x82	Reset_Communication. Carries out a reset of the communication functions. Objects 0x1000 - 0x1FFF are reset to their power-on defaults.

Sample 1

The following telegram puts all the modules in the network into the error state (outputs in a safe state):

11 bit identifier	2 byte of user data						
0x00	0x02	0x00					

Sample 2

The following telegram resets node 17:

11 bit identifier	2 byte of user data						
0x00	0x81	0x11					

Boot-up message

After the initialization phase and the self-test the Bus Coupler sends the boot-up message, which is a CAN message with a data byte (0) on the identifier of the guarding or heartbeat message: CAN-ID = 0x700 + node ID. In this way temporary failure of a module during operation (e.g. due to a voltage drop), or a module that is switched on at a later stage, can be reliably detected, even without Node Guarding. The sender can be determined from the message identifier (see default identifier allocation).

It is also possible, with the aid of the boot-up message, to recognize the nodes present in the network at start-up with a simple CAN monitor, without having to make write access to the bus (such as a scan of the network by reading out parameter 0x1000).

Finally, the boot-up message communicates the end of the initialization phase; the Bus Coupler signals that it can now be configured or started.



Firmware version BA

Up to firmware version BA the emergency identifier was used for the boot up message.

Format of the Boot-up message

11 bit identifier	1 byte of user data						
0x700 (=1792)+ node ID	0x00						

Node Monitoring

Heartbeat and guarding mechanisms are available to monitor failures in the CANopen network. These are of particular importance for CANopen, since modules do not regularly speak in the event-driven mode of operation. In the case of "guarding", the devices are cyclically interrogated about their status by means of a data request telegram (remote frame), whereas with "heartbeat" the nodes transmit their status on their own initiative.

Guarding: Node Guarding and Life Guarding

Node Guarding is used to monitor the non-central peripheral modules, while they themselves can use Life Guarding to detect the failure of the guarding master. Guarding involves the master sending remote frames (remote transmit requests) to the guarding identifier of the slaves that are to be monitored. These reply with the guarding message. This contains the slave's status code and a toggle bit that has to change after every message. If either the status or the toggle bit do not agree with that expected by the NMT master, or if there is no answer at all, the master assumes that there is a slave fault.

Guarding procedure

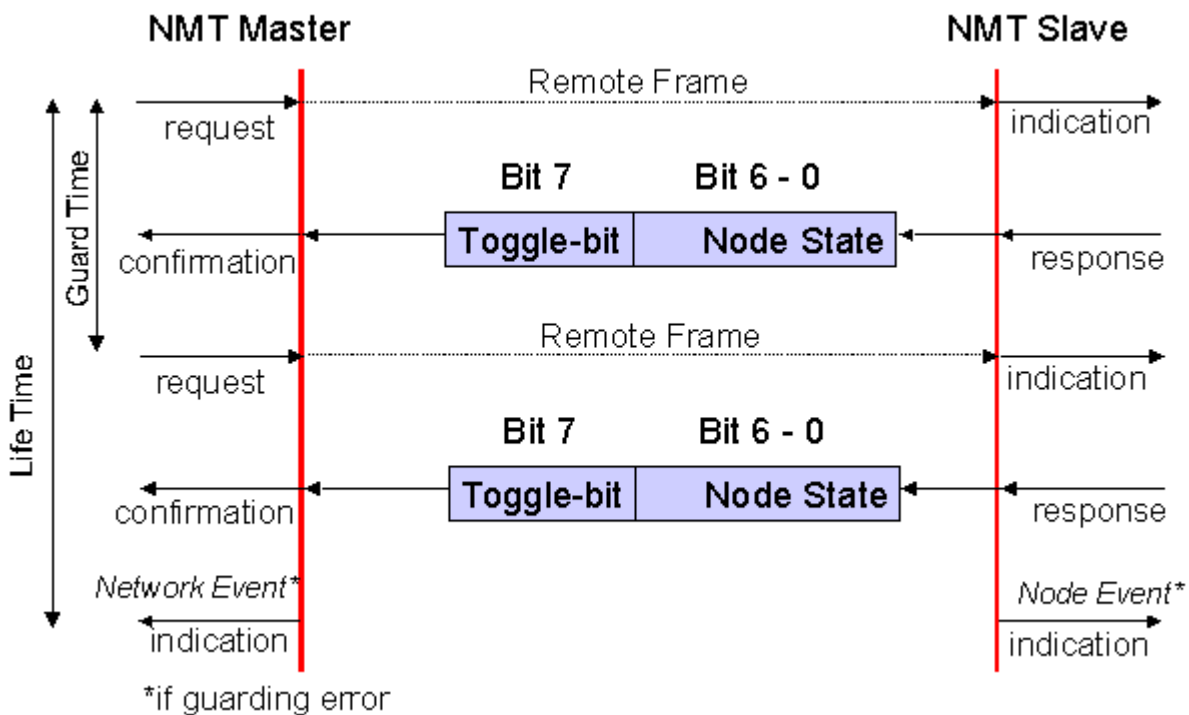

Fig. 129: Schematic diagram: "Guarding procedure"

Protocol

The toggle bit (t) transmitted in the first guarding telegram has the value 0. After this, the bit must change (toggle) in every guarding telegram so that the loss of a telegram can be detected. The node uses the remaining seven bits to transmit its network status (s):

s	Status
4 = 0x04	Stopped (previously: Prepared)
5 = 0x05	Operational
127 = 0x7F	Pre-Operational

Sample

The guarding message for node 27 (0x1B) must be requested by a remote frame having identifier 0x71B (1819_{dec}). If the node is *Operational*, the first data byte of the answer message alternates between 0x05 and 0x85, whereas in the *Pre-Operational* state it alternates between 0x7F and 0xFF.

Guard time and life time factor

If the master requests the guard messages in a strict cycle, the slave can detect the failure of the master. In this case, if the slave fails to receive a message request from the master within the set *Node Life Time* (a guarding error), it assumes that the master has failed (the watchdog function). It then puts its outputs into the error state, sends an emergency telegram, and returns to the pre-operational state. After a guarding time-out the procedure can be re-started by transmitting a guarding telegram again.

The node life time is calculated from the guard time (object 0x100C) and life time factor (object 0x100D) parameters:

Life time = guard time x life time factor

If either of these two parameters is "0" (the default setting), the master will not be monitored (no life guarding).

Heartbeat: Node Monitoring without Remote Frame

In the heart beat procedure, each node transmits its status message cyclically on its own initiative. There is therefore no need to use remote frames, and the bus is less heavily loaded than under the guarding procedure.

The master also regularly transmits its heartbeat telegram, so that the slaves are also able to detect failure of the master.

Heartbeat procedure

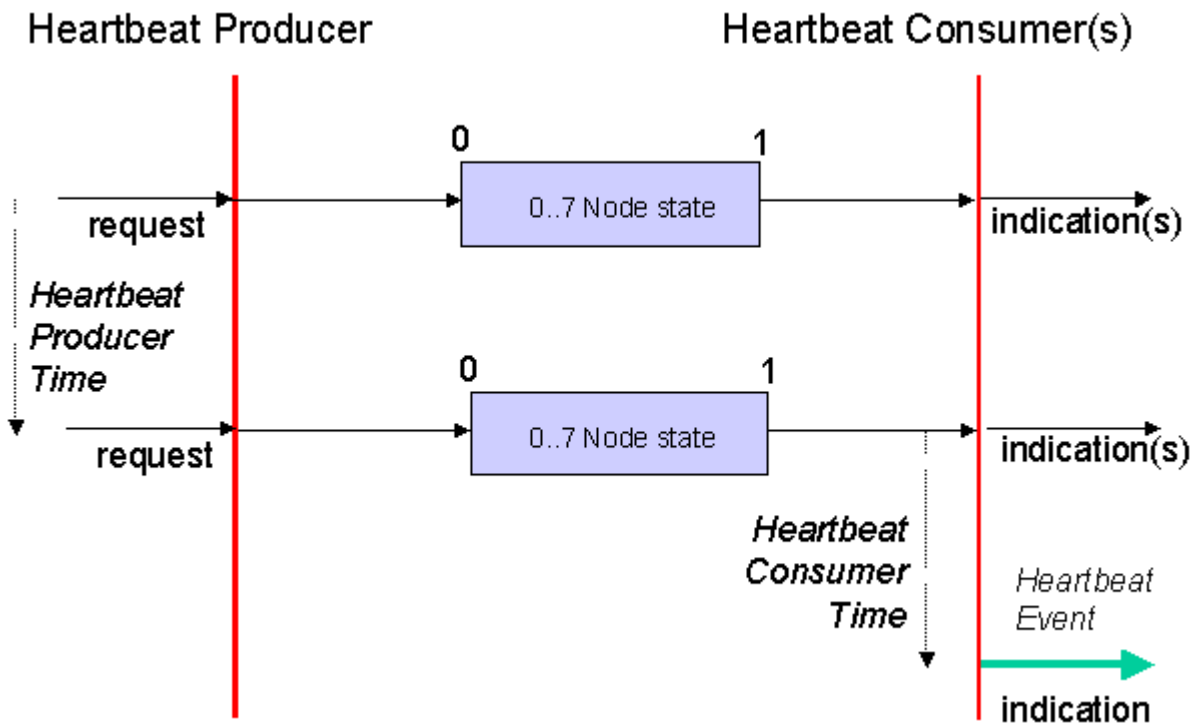

Fig. 130: Schematic diagram: "Heartbeat procedure"

Protocol

The toggle bit is not used in the heart beat procedure. The nodes send their status cyclically (s). See [Guarding \[137 \]](#).

6.2.2 Process Data Objects (PDO)

Introduction

In many fieldbus systems the entire process image is continuously transferred - usually in a more or less cyclic manner. CANopen is not limited to this communication principle, since the multi-master bus access protocol allows CAN to offer other methods. Under CANopen the process data is not transferred in a master/slave procedure, but follows instead the producer-consumer model. In this model, a bus node transmits its data, as a producer, on its own accord. This might, for example, be triggered by an event. All the other nodes listen, and use the identifier to decide whether they are interested in this telegram, and handle it accordingly. These are the consumers.

The process data in CANopen is divided into segments with a maximum of 8 bytes. These segments are known as process data objects (PDOs). The PDOs each correspond to a CAN telegram, whose specific CAN identifier is used to allocate them and to determine their priority. Receive PDOs (RxPDOs) and transmit PDOs (TxPDOs) are distinguished, the name being chosen from the point of view of the device: an input/output module sends its input data with TxPDOs and receives its output data in the RxPDOs. **This naming convention is retained in the TwinCAT System Manager.**

Communication parameters

The PDOs can be given different communication parameters according to the requirements of the application. Like all the CANopen parameters, these are also available in the device's object directory, and can be accessed by means of the service data objects. The parameters for the receive PDOs are at index 0x1400 (RxPDO1) onwards. There can be up to 512 RxPDOs (ranging up to index 0x15FF). In the same way, the entries for the transmit PDOs are located from index 0x1800 (TxPDO1) to 0x19FF (TxPDO512).

The Beckhoff Bus Couplers or Fieldbus Coupler Box modules make 16 RxPDO and TxPDOs available for the exchange of process data (although the figure for Economy and LowCost BK5110 and LC5100 Couplers and the Fieldbus Boxes is 5 PDOs each, since these devices manage a lower quantity of process data). The FC510x CANopen master card supports up to 192 transmit and 192 receive PDOs for each channel - although this is restricted by the size of the DPRAM. The EL6751 CANopen terminal dynamically organizes the process image; i.e. the process data are written in succession, enabling a higher data transmission rate. Up to 32 TxPDOs and 32 RxPDOs can be handled in slave mode.

For each existing process data object there is an associated communication parameter object. The TwinCAT System Manager automatically assigns the set parameters to the relevant object directory entries. These entries and their significance for the communication of process data are explained below.

PDO Identifier

The most important communication parameter in a PDO is the CAN identifier (also known as the communication object identifier, or COB-ID). It is used to identify the data, and determines their priority for bus access. For each CAN data telegram there may only be one sender node (producer), although all messages sent in the CAN broadcast procedure can be received, as described, by any number of nodes (consumers). Thus a node can make its input information available to a number of bus devices at the same time - even without transferring them through a logical bus master. The identifier is located in sub-index 1 of the communication parameter set. It is coded as a 32-bit value in which the least significant 11 bits (bits 0...10) contain the identifier itself. The data width of the object of 32 bits also allows 29-bit identifiers in accordance with CAN 2.0B to be entered, although the default identifiers always refer to the more usual 11-bit versions. Generally speaking, CANopen is economical in its use of the available identifiers, so that the use of the 29-bit versions remains limited to unusual applications. It is therefore also not supported by a Beckhoff's CANopen devices. The highest bit (bit 31) can be used to activate the process data object or to turn it off.

A complete [identifier list \[► 190\]](#) is provided in the appendix.

PDO linking

In the system of default identifiers, all the nodes (here: slaves) communicate with one central station (the master), since slave nodes do not listen by default to the transmit identifier of any other slave node.

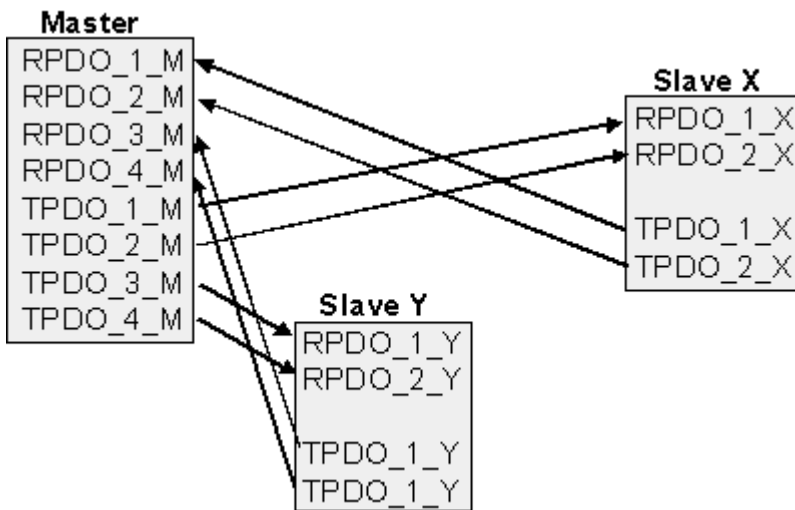

Fig. 131: Default identifier allocation: Master/Slave

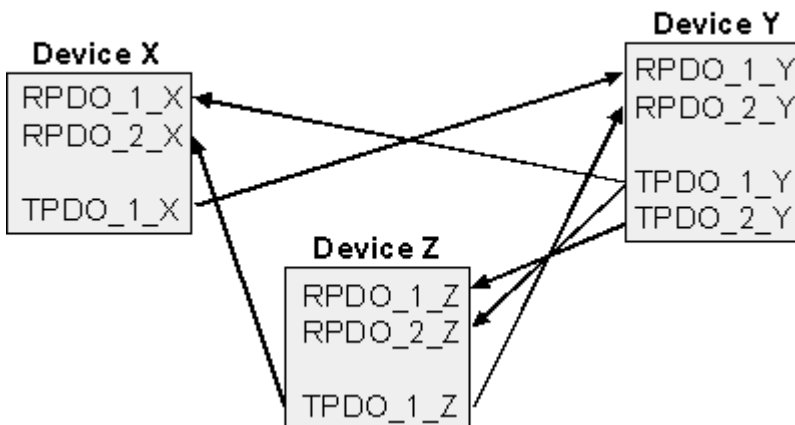

Fig. 132: PDO linking: Peer to Peer

If the consumer-producer model of CANopen PDOs is to be used for direct data exchange between nodes (without a master), the identifier allocation must be appropriately adapted, so that the TxPDO identifier of the producer agrees with the RxPDO identifier of the consumer: This procedure is known as PDO linking. It permits, for sample, easy construction of electronic drives in which several slave axes simultaneously listen to the actual value in the master axis TxPDO.

PDO Communication Types: Overview

CANopen offers a number of possible ways to transmit process data (see also: [Notes on PDO Parameterization](#) [► 146]).

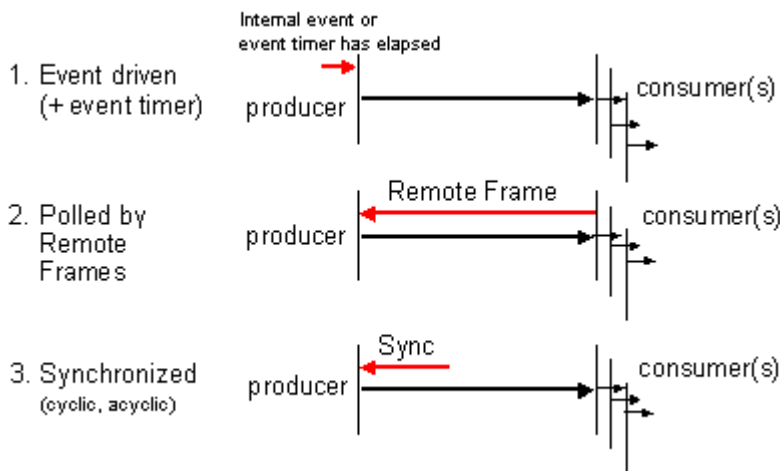

Fig. 133: Diagram: CAN process data transmission

Event driven

The "event" is the alteration of an input value, the data being transmitted immediately after this change. The event-driven flow can make optimal use of the bus bandwidth, since instead of the whole process image it is only the changes in it that are transmitted. A short reaction time is achieved at the same time, since when an input value changes it is not necessary to wait for the next interrogation from a master.

As from CANopen Version 4 it is possible to combine the event driven type of communication with a cyclic update. Even if an event has not just occurred, event driven TxPDOs are sent after the event timer has elapsed. If an event does occur, the event timer is reset. For RxPDOs the event timer is used as a watchdog in order to monitor the arrival of event driven PDOs . If a PDO does not arrive within a set period of time, the bus node adopts the error state.

Polled

The PDOs can also be polled by data request telegrams (remote frames). In this way it is possible to get the input process image of event-driven inputs onto the bus, even when they do not change, for instance through a monitoring or diagnostic device brought into the network while it is running. The time behavior of remote frame and response telegrams depends on what CAN controller is in use. Components with full integrated message filtering ("FullCAN") usually answer a data request telegram immediately, transmitting data that is waiting in the appropriate transmit buffer - it is the responsibility of the application to see that the data there is continuously updated. CAN controllers with simple message filtering (BasicCAN) on the other hand pass the request on to the application which can now compose the telegram with the latest data. This does take longer, but does mean that the data is up-to-date. Beckhoff use CAN controllers following the principle of Basic CAN.

Since this device behavior is usually not transparent to the user, and because there are CAN controllers still in use that do not support remote frames at all, polled communication can only with reservation be recommended for operative running.

Synchronized

It is not only for drive applications that it is worthwhile to synchronize the determination of the input information and the setting the outputs. For this purpose CANopen provides the SYNC object, a CAN telegram of high priority but containing no user data, whose reception is used by the synchronized nodes as a trigger for reading the inputs or for setting the outputs.

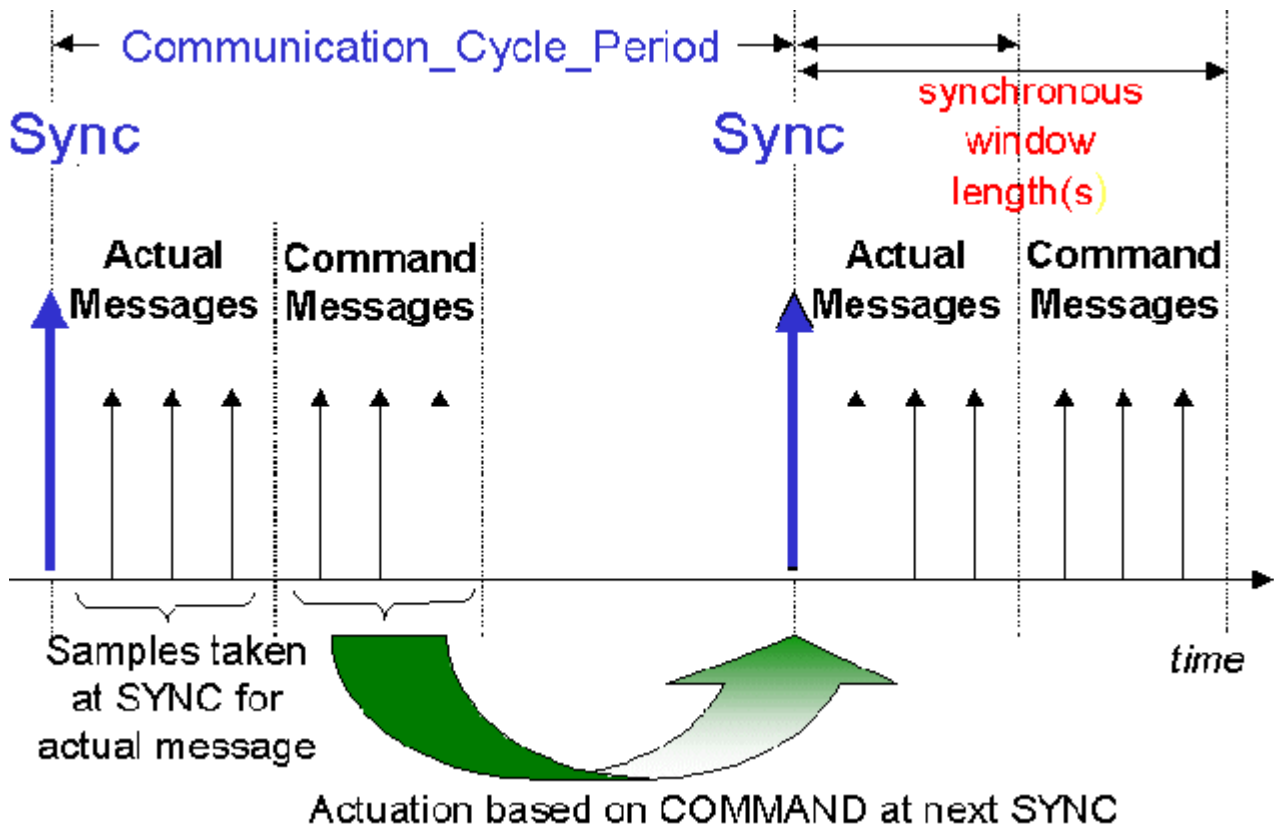

Fig. 134: Diagram: CAN "SYNC" telegram

PDO transmission types: Parameterization

The PDO transmission type parameter specifies how the transmission of the PDO is triggered, or how received PDOs are handled.

Transmission type	Cyclical	Acyclical	Synchronous	Asynchronous	Only RTR
0		X	X		
1-240	X		X		
241-251	- reserved -				
252			X		X
253				X	X
254, 255				X	

The type of transmission is parameterized for RxPDOs in the objects at 0x1400ff, sub-index 2, and for TxPDOs in the objects at 0x1800ff, sub-index 2.

Acyclic Synchronous

PDOs of transmission type 0 function synchronously, but not cyclically. An RxPDO is only evaluated after the next SYNC telegram has been received. In this way, for instance, axis groups can be given new target positions one after another, but these positions only become valid at the next SYNC - without the need to be constantly outputting reference points. A device whose TxPDO is configured for transmission type 0 acquires its input data when it receives the SYNC (synchronous process image) and then transmits it if the data correspond to an event (such as a change in input) having occurred. Transmission type 0 thus combines transmission for reasons that are event driven with a time for transmission (and, as far as possible, sampling) and processing given by the reception of "SYNC".

Cyclic Synchronous

In transmission types 1-240 the PDO is transmitted cyclically: after every "nth" SYNC (n = 1...240). Since transmission types can be combined on a device as well as in the network, it is possible, for example, for a fast cycle to be agreed for digital inputs (n = 1), whereas the data for analog inputs is transmitted in a slower

cycle (e.g. $n = 10$). RxPDOs do not generally distinguish between transmission types 0...240: a PDO that has been received is set to valid when the next SYNC is received. The cycle time (SYNC rate) can be monitored (object 0x1006), so that if the SYNC fails the device reacts in accordance with the definition in the device profile, and switches, for sample, its outputs into the error state.

The FC510x card / EL6751 terminal fully support the synchronous communication method: transmitting the SYNC telegram is coupled to the linked task, so that new input data is available every time the task begins. If a synchronous PDO does not arrive, this is detected and reported to the application.

Only RTR

Transmission types 252 and 253 apply to process data objects that are transmitted exclusively on request by a remote frame. 252 is synchronous: when the SYNC is received the process data is acquired. It is only transmitted on request. 253 is asynchronous. The data here is acquired continuously, and transmitted on request. This type of transmission is not generally recommended, because fetching input data from some CAN controllers is only partially supported. Because, furthermore, the CAN controllers sometimes answer remote frames automatically (without first requesting up-to-date input data), there are circumstances in which it is questionable whether the polled data is up-to-date. Transmission types 252 and 253 are for this reason not supported by the Beckhoff PC cards / terminals.

Asynchronous

The transmission types 254 + 255 are asynchronous, but may also be event-driven. In transmission type 254, the event is specific to the manufacturer, whereas for type 255 it is defined in the device profile. In the simplest case, the event is the change of an input value - this means that every change in the value is transmitted. The asynchronous transmission type can be coupled with the event timer, thus also providing input data when no event has just occurred.

Inhibit time

The "inhibit time" parameter can be used to implement a "transmit filter" that does not increase the reaction time for relatively new input alterations, but is active for changes that follow immediately afterwards. The inhibit time (transmit delay time) specifies the minimum length of time that must be allowed to elapse between the transmission of two of the same telegrams. If the inhibit time is used, the maximum bus loading can be determined, so that the worst case latency can then be found.

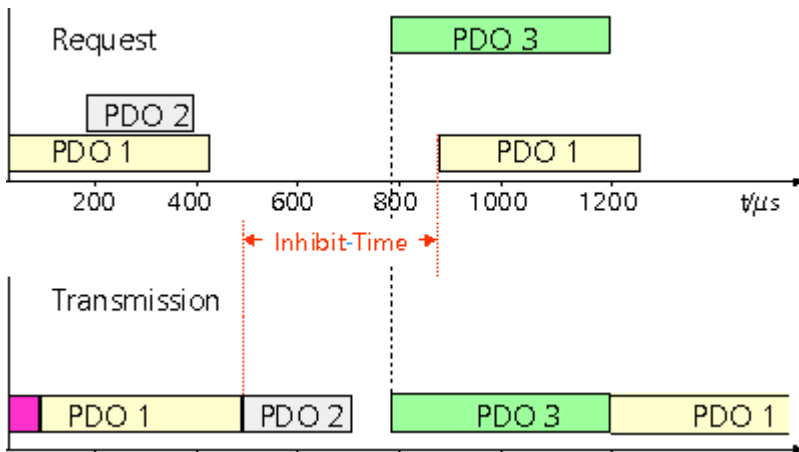

Fig. 135: Timing diagram: "Inhibit time"

Although the Beckhoff FC510x PC cards / EL6751 terminal can parameterize the inhibit time on slave devices, they do not themselves support it. The transmitted PDOs become automatically spread out (transmit delay) as a result of the selected PLC cycle time - and there is little value in having the PLC run faster than the bus bandwidth permits. The bus loading, furthermore, can be significantly affected by the synchronous communication.

Event Timer

An event timer for transmit PDOs can be specified by sub-index 5 in the communication parameters. Expiry of this timer is treated as an additional event for the corresponding PDO, so that the PDO will then be transmitted. If the application event occurs during a timer period, it will also be transmitted, and the timer is reset.

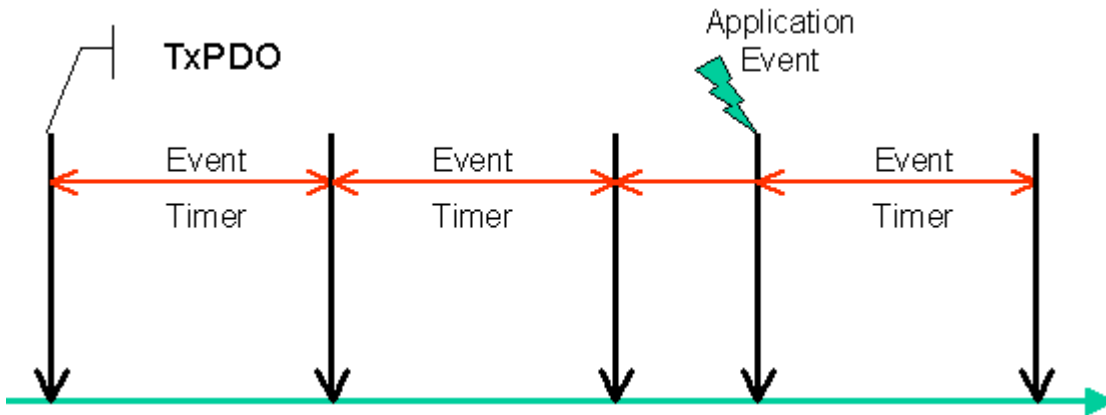

Fig. 136: Time representation of the event timer

In the case of receive PDOs, the timer is used to set a watchdog interval for the PDO: the application is informed if no corresponding PDO has been received within the set period. The FC510x / EL6751 can in this way monitor each individual PDO.

[Notes on PDO Parameterization \[► 146\]](#)

PDO Mapping

PDO mapping refers to mapping of the application objects (real time data) from the object directory to the process data objects. The CANopen device profile provide a default mapping for every device type, and this is appropriate for most applications. Thus the default mapping for digital I/O simply represents the inputs and outputs in their physical sequence in the transmit and receive process data objects.

The default PDOs for drives contain 2 bytes each of a control and status word and a set or actual value for the relevant axis.

The current mapping can be read by means of corresponding entries in the object directory. These are known as the mapping tables. The first location in the mapping table (sub-index 0) contains the number of mapped objects that are listed after it. The tables are located in the object directory at index 0x1600ff for the RxPDOs and at 0x1A00ff for the TxPDOs.

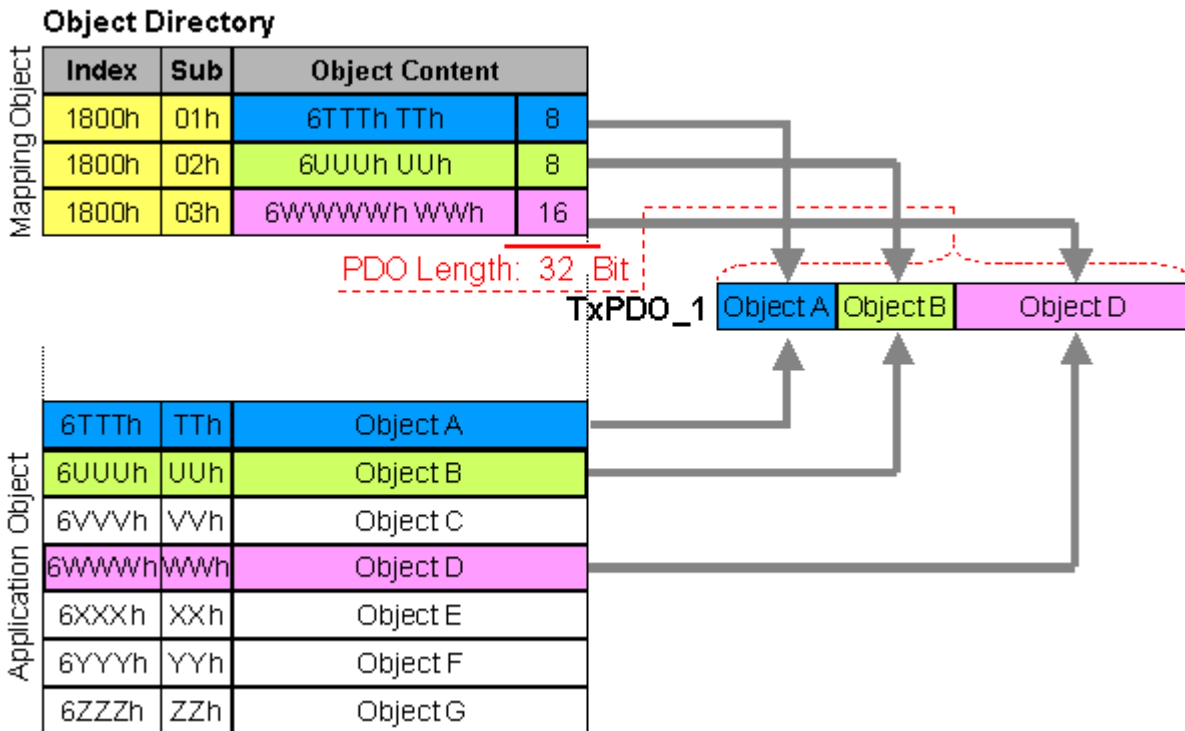

Fig. 137: Mapping representation

Digital and analog input/output modules: Read out the I/O number

The current number of digital and analog inputs and outputs can be determined or verified by reading out the corresponding application objects in the object directory:

Parameter	Object directory address
Number of digital input bytes	Index 0x6000, sub-index 0
Number of digital output bytes	Index 0x6200, sub-index 0
Number of analog inputs	Index 0x6401, sub-index 0
Number of analog outputs	Index 0x6411, sub-index 0

Variable mapping

As a rule, the default mapping of the process data objects already satisfies the requirements. For special types of application the mapping can nevertheless be altered: the Beckhoff CANopen Bus Couplers, for instance, thus support variable mapping, in which the application objects (input and output data) can be freely allocated to the PDOs. The mapping tables must be configured for this: as from Version 4 of CANopen, only the following procedure is permitted, and must be followed precisely:

1. First delete the PDO (set 0x1400ff, or 0x1800ff, sub-index 1, bit 31 to "1")
2. Set sub-index 0 in the mapping parameters (0x1600ff or 0x1A00ff) to "0"
3. Change mapping entries (0x1600ff or 0x1A00ff, SI 1..8)
4. Set sub-index 0 in the mapping parameters to the valid value. The device then checks the entries for consistency.
5. Create PDO by entering the identifier (0x1400ff or 0x1800ff, sub-index 1).

Dummy Mapping

A further feature of CANopen is the mapping of placeholders, or dummy entries. The data type entries stored in the object directory, which do not themselves have data, are used as placeholders. If such entries are contained in the mapping table, the corresponding data from the device is not evaluated. In this way, for instance, a number of drives can be supplied with new set values using a single CAN telegram, or outputs on a number of nodes can be set simultaneously, even in event-driven mode.

6.2.3 PDO Parameterization

Even though the majority of CANopen networks operate satisfactorily with the default settings, i.e. with the minimum of configuration effort, it is wise at least to check whether the existing bus loading is reasonable: 80% bus loading may be acceptable for a network operating purely in cyclic synchronous modes, but for a network with event-driven traffic this value would generally be too high, as there is hardly any bandwidth available for additional events.

Consider the Requirements of the Application

The communication of the process data must be optimized in the light of application requirements which are likely to be to some extent in conflict. These include

- Little work on parameterization - useable default values are optimal
- Guaranteed reaction time for specific events
- Cycle time for regulation processes over the bus
- Safety reserves for bus malfunctions (enough bandwidth for the repetition of messages)
- Maximum baud rate - depends on the maximum bus length
- Desired communication paths - who is speaking with whom

The determining factor often turns out to be the available bus bandwidth (bus load).

Baud rate

We generally begin by choosing the highest baud rate that the bus will permit. It should be borne in mind that serial bus systems are fundamentally more sensitive to interference as the baud rate is increased. The following rule therefore applies: just as fast as necessary. 1000 kbit/s are not usually necessary, and only to be unreservedly recommended on networks within a control cabinet where there is no electrical isolation between the bus nodes. Experience also tends to show that estimates of the length of bus cable laid are often over-optimistic - the length actually laid tends to be longer.

Determine the Communication Type

Once the baud rate has been chosen it is appropriate to specify the PDO communication type(s). These have different advantages and disadvantages:

- Cyclic synchronous communication provides an accurately predictable bus loading, and therefore a defined time behavior - you could say that the standard case is the worst case. It is easy to configure: The SYNC rate parameter sets the bus loading globally. The process images are synchronized: Inputs are read at the same time, output data is set valid simultaneously, although the quality of the synchronization depends on the implementation. The BECKHOFF FC510x PC cards / EL6751 CANopen terminal are capable of synchronizing the CANopen bus system with the cycles of the application program (PLC or NC).

The guaranteed reaction time under cyclic synchronous communication is always at least as long as the cycle time, and the bus bandwidth is not exploited optimally, since old data, i.e. data that has not changed, is continuously transmitted. It is however possible to optimize the network through the selection of different SYNC multiples (transmission types 1...240), so that data that changes slowly is transmitted less often than, for instance, time-critical inputs. It must, however, be borne in mind that input states that last for a time that is shorter than the cycle time will not necessarily be communicated. If it is necessary for such conditions to be registered, the associated PDOs for asynchronous communication should be provided.

- Event-driven asynchronous communication is optimal from the point of view of reaction time and the exploitation of bus bandwidth - it can be described as "pure CAN". Your choice must, however, also take account of the fact that it is not impossible for a large number of events to occur simultaneously, leading to corresponding delays before a PDO with a relatively low priority can be sent. Proper network planning therefore necessitates a worst-case analysis. Through the use of, for instance, [inhibit time](#) [▶ 139], it is also necessary to prevent a constantly changing input with a high PDO priority from blocking the bus (technically known as a "babbling idiot"). It is for this reason that event driving is switched off by default in the device profile of analog inputs, and must be turned on specifically. Time

windows for the transmit PDOs can be set using progress timers: the telegram is not sent again before the [inhibit time \[► 139\]](#) has elapsed, and not later than the time required for the progress timer to complete.

- The communication type is parameterized by means of the [transmission type \[► 139\]](#).

It is also possible to combine the two PDO principles. It can, for instance, be helpful to exchange the set and actual values of an axis controller synchronously, while limit switches, or motor temperatures with limit values are monitored with event-driven PDOs. This combines the advantages of the two principles: synchronicity for the axis communication and short reaction times for limit switches. In spite of being event-driven, the distributed limit value monitoring avoids a constant addition to the bus load from the analog temperature value.

In this sample it can also be of value to deliberately manipulate the identifier allocation, in order to optimize bus access by means of priority allocation: the highest priority is given to the PDO with the limit switch data, and the lowest to that with the temperature values.

Optimization of bus access latency time through modification of the identifier allocation is not, however, normally required. On the other hand the identifiers must be altered if masterless communication is to be made possible ([PDO linking \[► 139\]](#)). In this sample it would be possible for one RxPDO for each axis to be allocated the same identifier as the limit switch TxPDO, so that alterations of the input value can be received without delay.

Determining the Bus Loading

It is always worth determining the bus loading. But what bus loading values are permitted, or indeed sensible? It is first necessary to distinguish a short burst of telegrams in which a number of CAN messages follow one another immediately - a temporary 100% bus loading. This is only a problem if the sequence of receive interrupts that it caused at the CAN nodes cannot be handled. This would constitute a data overflow (or CAN queue overrun). This can occur at very high baud rates (> 500 kbit/s) at nodes with software telegram filtering and relatively slow or heavily loaded microcontrollers if, for instance, a series of remote frames (which do not contain data bytes, and are therefore very short) follow each other closely on the bus (at 1 Mbit/s this can generate an interrupt every 40 µs; for example, an NMT master might transmit all its guarding requests in an unbroken sequence). This can be avoided through skilled implementation, and the user should be able to assume that the device suppliers have taken the necessary trouble. A burst condition is entirely normal immediately after the SYNC telegram, for instance: triggered by the SYNC, all the nodes that are operating synchronously try to send their data at almost the same time. A large number of arbitration processes take place, and the telegrams are sorted in order of priority for transmission on the bus. This is not usually critical, since these telegrams do contain some data bytes, and the telegrams trigger a sequence of receive interrupts at the CAN nodes which is indeed rapid, but is nevertheless manageable.

Bus loading most often refers to the value averaged over several primary cycles, that is the mean value over 100-500 ms. CAN, and therefore CANopen, is indeed capable of managing a bus loading of close to 100% over long periods, but this implies that no bandwidth is available for any repetitions that may be necessitated by interference, for asynchronous error messages, parameterization and so on. Clearly, the dominant type of communication will have a large influence on the appropriate level of bus loading: a network with entirely cyclic synchronous operation is always in any case near to the worst case state, and can therefore be operated with values in the 70-80% range. The figure is very hard to state for an entirely event-driven network: an estimate must be made of how many events additional to the current state of the system might occur, and of how long the resulting burst might last - in other words, for how long the lowest priority message will be delayed. If this value is acceptable to the application, then the current bus loading is acceptable. As a rule of thumb it can usually be assumed that an event-driven network running with a base loading of 30-40% has enough reserve for worst-case scenarios, but this assumption does not obviate the need for a careful analysis if delays could have critical results for the plant.

The BECKHOFF FC510x CANopen master cards / EL6751 CANopen master terminal display the bus load via the System Manager. This variable can also be processed in the PLC, or can be displayed in the visualization system.

The amount data in the process data objects is of course as relevant as the communication parameters: the [PDO mapping. \[► 144\]](#)

6.2.4 Service Data Objects (SDO)

The parameters listed in the object directory are read and written by means of service data objects. These SDOs are *Multiplexed Domains*, i.e. data structures of any size that have a multiplexer (address). The multiplexer consists of a 16-bit index and an 8-bit sub-index that address the corresponding entries in the object directory.

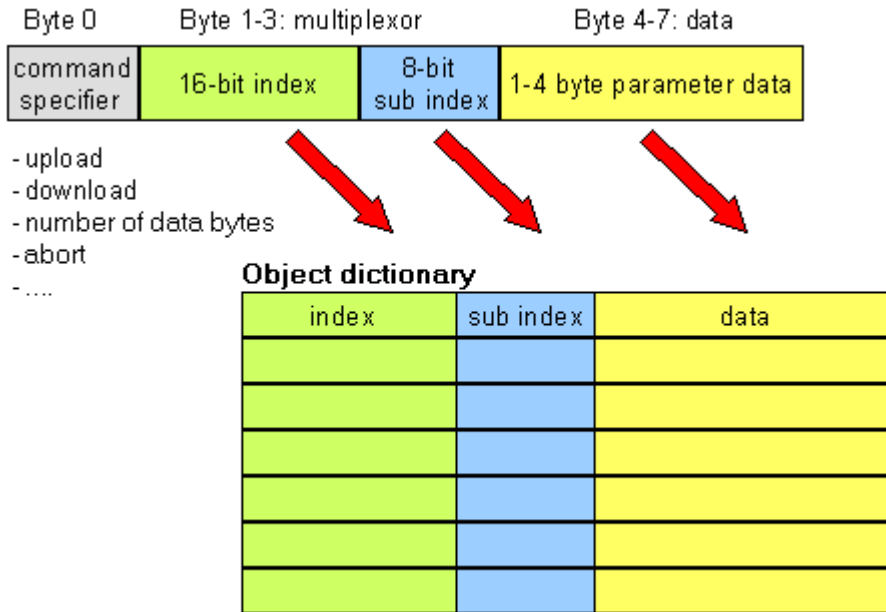

Fig. 138: SDO protocol: access to the object directory

The CANopen Bus Couplers are servers for the SDO, which means that at the request of a client (e.g. of the IPC or the PLC) they make data available (upload), or they receive data from the client (download). This involves a handshake between the client and the server.

When the size of the parameter to be transferred is not more than 4 bytes, a single handshake is sufficient (one telegram pair): For a download, the client sends the data together with its index and sub-index, and the server confirms reception. For an upload, the client requests the data by transmitting the index and sub-index of the desired parameter, and the server sends the parameter (including index and sub-index) in its answer telegram.

The same pair of identifiers is used for both upload and download. The telegrams, which are always 8 bytes long, encode the various services in the first data byte. All parameters with the exception of objects 1008h, 1009h and 100Ah (device name, hardware and software versions) are only at most 4 bytes long, so this description is restricted to transmission in expedited transfer.

Protocol

The structure of the SDO telegrams is described below.

Client -> Server, Upload Request

11 bit identifier	8 byte user data							
0x600 (=1536dec) + node ID	0x40	Index0	Index1	SubIdx	0x00	0x00	0x00	0x00

Parameter	Explanation
Index0	Index low byte (Unsigned16, LSB)
Index1	Index high byte (Unsigned16, MSB)
SubIdx	Sub-index (Unsigned8)

Client -> Server, Upload Response

11 bit identifier	8 byte user data							
0x580 (=1408dec) + node ID	0x4x	Index0	Index1	SubIdx	Data0	Data1	Data2	Data3

Parameter	Explanation
Index0	Index low byte (Unsigned16, LSB)
Index1	Index high byte (Unsigned16, MSB)
SubIdx	Sub-index (Unsigned8)
Data0	Data low low byte (LLSB)
Data3	Data high high byte (MMSB)

Parameters whose data type is Unsigned8 are transmitted in byte D0, parameters whose type is Unsigned16 use D0 and D1.

The number of valid data bytes is coded as follows in the first CAN data byte (0x4x):

Number of parameter bytes	1	2	3	4
First CAN data byte	0x4F	0x4B	0x47	0x43

Client -> Server, Download Request

11 bit identifier	8 byte user data							
0x600 (=1536dec) + node ID	0x22	Index0	Index1	SubIdx	Data0	Data1	Data2	Data3

Parameter	Explanation
Index0	Index low byte (Unsigned16, LSB)
Index1	Index high byte (Unsigned16, MSB)
SubIdx	Sub-index (Unsigned8)
Data0	Data low low byte (LLSB)
Data3	Data high high byte (MMSB)

It is optionally possible to give the number of valid parameter data bytes in the first CAN data byte

Number of parameter bytes	1	2	3	4
First CAN data byte	0x2F	0x2B	0x27	0x23

This is, however, not generally necessary, since only the less significant data bytes up to the length of the object directory entry that is to be written are evaluated. A download of data up to 4 bytes in length can therefore always be achieved in BECKHOFF bus nodes with 22 h in the first CAN data byte.

Client -> Server, Download Response

11 bit identifier	8 byte user data							
0x580 (=1408dec) + node ID	0x60	Index0	Index1	SubIdx	0x00	0x00	0x00	0x00

Parameter	Explanation
Index0	Index low byte (Unsigned16, LSB)
Index1	Index high byte (Unsigned16, MSB)
SubIdx	Sub-index (Unsigned8)

Breakdown of Parameter Communication

Parameter communication is interrupted if it is faulty. The client or server send an SDO telegram with the following structure for this purpose:

11 bit identifier	8 byte user data							
0x580 (client) or 0x600(server) + node ID	0x80	Index0	Index1	SubIdx	Error0	Error1	Error2	Error3

Parameter	Explanation
Index0	Index low byte (Unsigned16, LSB)
Index1	Index high byte (Unsigned16, MSB)
SubIdx	Sub-index (Unsigned8)
Error0	SDO error code low low byte (LLSB)
Error3	SDO error code high high byte (MMSB)

List of SDO error codes (reason for abortion of the SDO transfer):

SDO error code	Explanation
0x05 03 00 00	Toggle bit not changed
0x05 04 00 01	SDO command specifier invalid or unknown
0x06 01 00 00	Access to this object is not supported
0x06 01 00 02	Attempt to write to a Read_Only parameter
0x06 02 00 00	The object is not found in the object directory
0x06 04 00 41	The object cannot be mapped into the PDO
0x06 04 00 42	The number and/or length of mapped objects would exceed the PDO length
0x06 04 00 43	General parameter incompatibility
0x06 04 00 47	General internal error in device
0x06 06 00 00	Access interrupted due to hardware error
0x06 07 00 10	Data type or parameter length do not agree or are unknown
0x06 07 00 12	Data type does not agree, parameter length too great
0x06 07 00 13	Data type does not agree, parameter length too short
0x06 09 00 11	Sub-index not present
0x06 09 00 30	General value range error
0x06 09 00 31	Value range error: parameter value too great
0x06 09 00 32	Value range error: parameter value too small
0x06 0A 00 23	Resource not available
0x08 00 00 21	Access not possible due to local application
0x08 00 00 22	Access not possible due to current device status

Further, manufacturer-specific error codes have been introduced for register communication (index 0x4500, 0x4501):

SDO error code	Explanation
0x06 02 00 11	Invalid table: Table or channel not present
0x06 02 00 10	Invalid register: table not present
0x06 01 00 22	Write protection still set
0x06 07 00 43	Incorrect number of function arguments
0x06 01 00 21	Function still active, try again later
0x05 04 00 40	General routing error
0x06 06 00 21	Error accessing BC table
0x06 09 00 10	General error communicating with terminal
0x05 04 00 47	Time-out communicating with terminal

6.2.5 Identifier Allocation

Default Identifier

CANopen provides default identifiers for the most important communication objects, and these are derived from the 7-bit node address (the node ID) and a 4-bit function code in accordance with the following scheme:

11 Bit Identifier

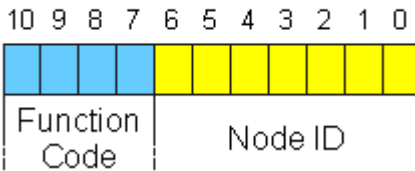

Fig. 139: Default Identifier

For broadcast objects the node ID is set to 0. This gives rise to the following default identifiers:

Broadcast objects

Object	Function	Function Code	resulting COB ID		Object for Comm. Parameter / Mapping
			hex	dec	
NMT	Boot-Up	0	0x00	0	- / -
SYNC	Synchronization	1	0x80	128	0x1005 [▶ 157]+0x1006 [▶ 157] / -

Peer-to-peer objects

Object	Function	Function Code	resulting COB ID		Object for Comm. Parameter / Mapping
			hex	dec	
Emergency	Status / error	1	0x81 - 0xFF	129 - 255	- / -
PDO1 (tx)	dig. inputs	11	0x181 - 0x1FF	385 - 511	0x1800 [▶ 164] / 0x1A00 [▶ 165]
PDO1 (rx)	digital outputs	100	0x201 - 0x27F	513 - 639	0x1400 [▶ 161] / 0x1600 [▶ 162]
PDO2 (tx)	analog inputs	101	0x281 - 0x2FF	641 - 767	0x1801 [▶ 164] / 0x1A01 [▶ 166]
PDO2 (rx)	analog outputs	110	0x301 - 0x37F	769 - 895	0x1401 [▶ 161] / 0x1601 [▶ 163]
PDO3 (tx)	analog inputs*	111	0x381 - 0x3FF	897 - 1023	0x1802 [▶ 164] / 0x1A02 [▶ 166]
PDO3 (rx)	analog outputs*	1000	0x401 - 0x47F	1025 - 1151	0x1402 [▶ 161] / 0x1602 [▶ 163]
PDO4 (tx)	analog inputs*	1001	0x481 - 0x4FF	1153 - 1279	0x1803 [▶ 165] / 0x1A03 [▶ 166]
PDO4 (rx)	analog outputs*	1010	0x501 - 0x57F	1281 - 1407	0x1403 [▶ 162] / 0x1603 [▶ 163]
SDO (tx)	Parameter	1011	0x581 - 0x5FF	1409 - 1535	- / -
SDO (rx)	Parameter	1100	0x601 - 0x67F	1537 - 1663	- / -
Guarding	Life and node guarding, heartbeat, boot-up message	1110	0x701 - 0x77F	1793 - 1919	(0x100C [▶ 158], 0x100D [▶ 158], 0x100E [▶ 158], 0x1016 [▶ 159], 0x1017 [▶ 160])

*) The Beckhoff Default Mapping applies to PDO3 and PDO4. In most configurations, PDOs 3+4 contain data related to analog inputs and outputs, but there can also be "excess" data from digital I/Os, or data from special terminals. Details may be found in the section covering [PDO Mapping \[▶ 139\]](#).

Up until version 3 of the CANopen specification, default identifiers were assigned to 2 PDOs at a time. The BECKHOFF Bus Couplers up to firmware version BA correspond to this issue of the specification. After firmware version C0 (CANopen version 4), default identifiers are provided for up to 4 PDOs.

Manufacture-Specific Default Identifiers for Additional PDOs

Default identifier for additional PDOs

Identifiers are not assigned to the additional PDOs that are filled by the Beckhoff Bus Couplers in accordance with the standard scheme. The user must enter an identifier for these PDOs in the object directory. It is easier to activate the occupied PDOs by means of object [0x5500](#) [[▶ 174](#)].

This entry in the object directory extends the default identifier allocation up to 11 PDOs. This creates the following identifiers:

Object	Function Code	Resulting COB ID (hex)	Resulting COB ID (dec)
PDO5 (tx)	1101	0x681 - 0x6BF	1665 - 1727
PDO5 (rx)	1111	0x781 - 0x7BF	1921 - 1983
PDO6 (tx)	111	0x1C1 - 0x1FF	449 - 511
PDO6 (rx)	1001	0x241 - 0x27F	577 - 639
PDO7 (tx)	1011	0x2C1 - 0x2FF	705 - 767
PDO7 (rx)	1101	0x341 - 0x37F	833 - 895
PDO8 (tx)	1111	0x3C1 - 0x3FF	961 - 1023
PDO8 (rx)	10001	0x441 - 0x47F	1089 - 1151
PDO9 (tx)	10011	0x4C1 - 0x4FF	1217 - 1279
PDO9 (rx)	10101	0x541 - 0x57F	1345 - 1407
PDO10 (tx)	10111	0x5C1 - 0x5FF	1473 - 1535
PDO10 (rx)	11001	0x641 - 0x67F	1601 - 1663
PDO11 (tx)	11011	0x6C1 - 0x6FF	1729 - 1791
PDO11 (rx)	11101	0x741 - 0x77F	1857 - 1919

NOTE

Index 0x5500

Index 0x5500 must not be used if Bus Couplers with more than 5 PDOs are present in networks with node numbers greater than 64, otherwise identifier overlaps can occur.

6.3 Object directory

6.3.1 Object directory structure

All the CANopen objects relevant for the Bus Coupler are entered into the CANopen object directory. The object directory is divided into three different regions:

1. communication-specific profile region (index 0x1000 – 0x1FFF).
This contains the description of all the parameters specific to communication.
2. manufacturer-specific profile region (index 0x2000 – 0x5FFF).
Contains the description of the manufacturer-specific entries.
3. standardized device profile region (0x6000 – 0x9FFF).
Contains the objects for a device profile according to DS-401.

Every entry in the object directory is identified by a 16 bit index. If an object consists of several components (e.g. object type array or record), the components are identified by an 8-bit subindex. The object name describes the function of an object, while the data type attribute specifies the data type of the entry. The access attribute specifies whether an entry may only be read, only written, or may be both read and written.

Communication-specific region

All the parameters and objects necessary for the CANopen Bus Coupler's communication are in this region of the object directory. The region from 0x1000 to 0x1018 contains various general communication-specific parameters (e.g. the device name).

The communication parameters (e.g. identifiers) for the receive PDOs are located in the region from 0x1400 to 0x140F (plus subindex). The mapping parameters of the receive PDOs are in the region from 0x1600 to 0x160F (plus subindex). The mapping parameters contain the cross-references to the application objects that are mapped into the PDOs and the data width of the corresponding object (see also the section dealing with PDO Mapping).

The communication and mapping parameters for the transmit PDOs are located in the regions from 0x1800 to 0x180F and from 0x1A00 to 0x1A0F.

Manufacturer-specific region

This region contains entries that are specific to BECKHOFF, e.g.:

- data objects for special terminals
- objects for register communication providing access to all the Bus Couplers' and Bus Terminals' internal registers
- objects for simplified configuration of the PDOs

Standardized device profile region

The standardized device profile region supports the device profile of CANopen DS-401, Version 1. Functions are available for analog inputs that can adapt communication in the event-driven operating mode to the requirements of the application and to minimize the loading of the bus:

- Limit value monitoring
- Delta function
- activation/deactivation of event-driven mode

6.3.2 Object list

● Reachability of the objects and registers



The objects in the object directory can be reached by SDO access, but not generally through the KS2000 configuration software. On the other hand, all the registers that can be configured with KS2000 can also be reached using SDO access to the object directory (objects 0x4500 and 0x4501) - even though this does not offer the same convenience as the KS2000 software.

Parameter	Index	BK5120/BK515x	BK5110	LC5100	BX5100/BC5150	CX8051/B510
Device type [▶ 156]	0x1000	x	x	x		x
Error register [▶ 156]	0x1001	x	x	x	x	x *
Error memory [▶ 156]	0x1003	x	x	x		x *
Sync Identifier [▶ 157]	0x1005	x	x	x	x	x
Sync Interval [▶ 157]	0x1006	x	x	x	x	x
Device name [▶ 157]	0x1008	x	x	x	x	x *
Hardware version [▶ 157]	0x1009	x	x	x		x *
Software version [▶ 158]	0x100A	x	x	x	x	x *
Node number [▶ 158]	0x100B	x	x	x		
Guard Time [▶ 158]	0x100C	x	x	x	x	x
Life Time Factor [▶ 158]	0x100D	x	x	x	x	x
Guarding Identifier [▶ 158]	0x100E	x	x	x		
Save parameters [▶ 158]	0x1010	x	x	x		
Load default values [▶ 159]	0x1011	x	x	x		
Emergency Identifier [▶ 159]	0x1014	x	x	x		
Consumer Heartbeat Time [▶ 159]	0x1016	x	x	x	x	x
Producer Heartbeat Time [▶ 160]	0x1017	x	x	x	x	x
Device identifier (identity object) [▶ 160]	0x1018	x	x	x	x	x *
Server SDO parameters [▶ 160]	0x1200	x	x	x		
Communication parameters for the 1st - 5th RxPDOs [▶ 161]	0x1400 - 0x1404	x	x	x	x	x
Communication parameters for the 6th - 16th RxPDOs [▶ 162]	0x1405 - 0x140F	x			x	x
Communication parameters for the 17th - 32nd RxPDOs [▶ 162]	0x1410 - 0x141F				x only BX5100	x
Mapping 1st - 5th RxPDO [▶ 162]	0x1600 - 0x1604	x	x	x	x	x
Mapping 6th - 16th RxPDO [▶ 163]	0x1605 - 0x160F	x			x	x
Mapping 17th - 32nd RxPDO [▶ 163]	0x1610 - 0x161F				x only BX5100	x
Communication parameters for the 1st - 5th TxPDOs [▶ 164]	0x1800 - 0x1804	x	x	x	x	x
Communication parameters for the 6th - 16th TxPDOs [▶ 165]	0x1805 - 0x180F	x			x	x
Communication parameters for the 17th - 32nd TxPDOs [▶ 165]	0x1810 - 0x181F				x only BX5100	x
Mapping 1st - 5th TxPDO [▶ 165]	0x1A00 - 0x1A04	x	x	x	x	x
Mapping 6th - 16th TxPDO [▶ 166]	0x1A05 - 0x1A0F	x			x	x
Mapping 17th - 32nd TxPDO [▶ 166]	0x1A10 - 0x1A1F				x only BX5100	x

Parameter	Index	BK5120/BK515x	BK5110	LC5100	BX5100/BC5150	CX8051/B510
Flag area %MB0-511	0x2F00				x	
Flag area %MB511-1023	0x2F01				x	
Flag area %MB1024-1535	0x2F02				x	
Flag area %MB1536-2047	0x2F03				x	
Flag area %MB2048-2559	0x2F04				x	
Flag area %MB2560-3071	0x2F05				x	
Flag area %MB3072-3584	0x2F06				x	
Flag area %MB3585-4095	0x2F07				x	
3-byte special terminals, input data [▶ 167]	0x2600	x				
3-byte special terminals, output data [▶ 167]	0x2700	x				
4-byte special terminals, input data [▶ 167]	0x2800	x				
4-byte special terminals, output data [▶ 167]	0x2900	x				
5-byte special terminals, input data [▶ 168]	0x2A00	x				
5-byte special terminals, output data [▶ 168]	0x2B00	x				
6-byte special terminals, input data [▶ 168]	0x2C00	x				
6-byte special terminals, output data [▶ 168]	0x2D00	x				
8-byte special terminals, input data [▶ 169]	0x3000	x				
8-byte special terminals, output data [▶ 169]	0x3100	x				
Bus node register communication [▶ 169]	0x4500	x	x	x		
Bus Terminal / Extension Box register communication [▶ 173]	0x4501	x	x	x		
Activate PDOs [▶ 174]	0x5500	x	x	x		
NetId [▶ 179]	0x5FFE				x	
Digital inputs [▶ 176]	0x6000	x	x	x		
Interrupt mask [▶ 176]	0x6126	x	x	x		
Digital outputs [▶ 177]	0x6200	x	x	x		
Analog inputs [▶ 177]	0x6401	x				
Analog outputs [▶ 178]	0x6411	x				
Event control analog inputs [▶ 178]	0x6423	x				
Upper limit value analog inputs [▶ 178]	0x6424	x				
Lower limit value analog inputs [▶ 178]	0x6425	x				
Delta function for analog inputs [▶ 179]	0x6426	x				

*) When an ADS server is registered, these objects are relayed to the PLC via ADS notification and have to be answered there.

6.3.3 Objects and Data

Device type

Index	Subindex	Name	Type	Attribute	Mapping	Default value	Meaning
0x1000	0	Device Type	Unsigned32	ro	N	0x00000000	Statement of device type

The 32-bit value is divided into two 16-bit fields:

MSB	LSB
Additional Information	Device profile number
0000 0000 0000 wxyz	0x191 (401 _{dec})

The *additional information* section contains information about the signal types of the I/O device:

z=1 means digital inputs,
y=1 signifies digital outputs,
x=1 signifies analog inputs,
w=1 signifies analog outputs.

A BK5120 with digital and analog inputs, but with no outputs, thus returns 0x00 05 01 91.

Special terminals (such as serial interfaces, PWM outputs, incremental encoder inputs) are not considered. A Coupler that, e.g. only has KL6001 serial interface terminals plugged in, thus returns 0x00 00 01 91.

The device type supplies only a rough classification of the device. The terminal identifier register of the Bus Coupler can be read for detailed identification of the Bus Couplers and the attached terminals (for details see Register communication index 0x4500).

Error register

Index	Subindex	Name	Type	Attribute	Mapping	Default value	Meaning
0x1001	0	Error Register	Unsigned8	ro	N	0x00	Error register

The 8-bit value is coded as follows:

Bit 7	Bit 6	Bit 5	Bit 4	Bit 3	Bit 2	Bit 1	Bit 0
ManSpec.	reserved	reserved	Comm.	reserved	reserved	reserved	Generic

ManSpec.: Manufacturer-specific error, specified more precisely in object 1003.

Comm.: Communication error (CAN overrun)

Generic: An error that is not more precisely specified has occurred (the flag is set at every error message)

Error memory

Index	Subindex	Name	Type	Attribute	Mapping	Default value	Meaning
0x1003	0x00	Predefined error field (error memory)	Unsigned8	rw	N	0x00	Object 1003h contains a description of the error that has occurred in the device - subindex 0 has the number of error states stored.
	1	Actual error	Unsigned32	ro	N	none	Last error state to have occurred
	--
	10	Standard error field	Unsigned32	ro	N	none	A maximum of 10 error states are stored.

The 32 bit value in the error memory is divided into two 16 bit fields:

MSB	LSB
Additional Code	Error Code

The additional code contains the error trigger (see emergency object) and thereby a detailed error description.

New errors are always saved at subindex 1, all the other subindices being appropriately incremented. The whole error memory is cleared by writing a 0 to subindex 0.

If there has not been an error since power up, then object 0x1003 only consists of subindex 0 with a 0 entered into it. The error memory is cleared by a reset or a power cycle.

As is usual in CANopen, the LSB is transferred first, followed by the MSB.

Sync Identifier

Index	Subindex	Name	Type	Attribute	Mapping	Default value	Meaning
0x1005	0	COB-ID Sync Message	Unsigned32	rw	N	0x80000080	Identifier of the SYNC message

The bottom 11 bits of the 32-bit value contain the identifier (0x80=128dec). Bit 30 indicates whether the device sends the SYNC telegram (1) or not (0). The CANopen I/O devices receive the SYNC telegram, and accordingly bit 30=0. For reasons of backwards compatibility, bit 31 has no significance.

Sync Interval

Index	Subindex	Name	Type	Attribute	Mapping	Default value	Meaning
0x1006	0	Communication cycle period	Unsigned32	rw	N	0x00000000	Length of the SYNC interval in µs.

If a value other than zero is entered here, the bus node will go into the error state if, during synchronous PDO operation, no SYNC telegram is received within the watchdog time. The watchdog time corresponds here to 1,5 times the communication cycle period that has been set - the planned SYNC interval can therefore be entered.

The I/O update for Beckhoff CANopen bus nodes is carried out directly after a SYNC telegram was received, if the following conditions are met:

- Firmware version from C0 (from CANopen version 4.01).
- all PDOs that have data are set to synchronous communication (0...240).
- Sync interval has been entered in object 0x1006 and (sync interval x lowest PDO transmission type) is less than 90ms.

The modules are then synchronized throughout.

Device name

Index	Subindex	Name	Type	Attribute	Mapping	Default value	Meaning
0x1008	0	Manufacturer Device Name	Visible String	ro	N	BK51x0, LC5100, IPxxxx-B510 or ILxxxx-B510	Device name of the bus node

Since the returned value is longer than 4 bytes, the segmented SDO protocol is used for transmission.

Hardware version

Index	Subindex	Name	Type	Attribute	Mapping	Default value	Meaning
0x1009	0	Manufacturer hardware-version	Visible String	ro	N	-	Hardware version number of the bus node

Since the returned value is longer than 4 bytes, the segmented SDO protocol is used for transmission.

Software version

Index	Subindex	Name	Type	Attribute	Mapping	Default value	Meaning
0x100A	0	Manufacturer software-version	Visible String	ro	N	-	Software version number of the bus node

Since the returned value is longer than 4 bytes, the segmented SDO protocol is used for transmission.

Node number

Index	Subindex	Name	Type	Attribute	Mapping	Default value	Meaning
0x100B	0	Node-ID	Unsigned32	ro	N	none	Set node number

The node number is supported for reasons of compatibility.

Guard Time

Index	Subindex	Name	Type	Attribute	Mapping	Default value	Meaning
0x100C	0	Guard Time [ms]	Unsigned16	rw	N	0	Interval between two guard telegrams. Is set by the NMT master or configuration tool.

Life Time Factor

Index	Subindex	Name	Type	Attribute	Mapping	Default value	Meaning
0x100D	0	Life Time Factor	Unsigned8	rw	N	0	Life time factor x guard time = life time (watchdog for life guarding)

If a guarding telegram is not received within the life time, the node enters the error state. If the life time factor and/or guard time = 0, the node does not carry out any life guarding, but can itself be monitored by the master (node guarding).

Guarding Identifier

Index	Subindex	Name	Type	Attribute	Mapping	Default value	Meaning
0x100E	0	COB-ID guarding protocol	Unsigned32	ro	N	0x000007xy, xy = NodeID	Identifier of the guarding protocol

The guarding identifier is supported for reasons of compatibility. Changing the guarding identifier has no longer been permitted since version 4 of CANopen.

Save parameters

Index	Subindex	Name	Type	Attribute	Mapping	Default value	Meaning
0x1010	0	Store Parameter	Unsigned8	ro	N	1	Number of store options
	1	store all parameters	Unsigned32	rw	N	1	Stores all (storable) parameters

By writing the string `save` in ASCII code (hexadecimal 0x657666173) to subindex 1, the current parameters are placed into non-volatile storage. (The byte sequence on the bus including the SDO protocol: 0x23 0x10 0x10 0x01 0x73 0x61 0x76 0x65).

The saving operation takes around three seconds. If successful, an acknowledgement is issued via the corresponding TxSDO (0x60 in the first byte). Since the Bus Coupler is unable to send or receive any CAN telegrams during the storage process, saving is only possible when the node is in the pre-operational state. It is recommended that the entire network is placed into the pre-operational state before such storage. This avoids a buffer overflow.

Data saved includes:

- The terminals currently inserted (the number of each terminal category)
- All PDO parameters (identifier, transmission type, inhibit time, mapping).

Valid identifiers

I The stored identifiers apply afterwards, not the default identifiers derived from the node addresses. Any changes in the DIP switch settings then no longer affect the PDOs.

- All SYNC parameters
- All guarding parameters
- Limit values, delta values and interrupt enables for analog inputs

Parameters directly stored in the terminals by way of register communication are immediately stored there in non-volatile form.

Load default values

Index	Subindex	Name	Type	Attribute	Mapping	Default value	Meaning
0x1011	0	Restore Parameter	Unsigned8	ro	N	4	Number of reset options
	1	Restore all parameters	Unsigned32	rw	N	1	Resets all parameters to their default values
	4	Set manufacturer Defaults	Unsigned32	rw	N	1	Resets all coupler parameters to manufacturer's settings (including registers)

Writing the string *load* in ASCII code (hexadecimal 0x64616663) into subindex 1 resets all parameters to default values (as initially supplied) **at the next boot (reset)**.

(The byte sequence on the bus including the SDO protocol: 0x23 0x11 0x10 0x01 0x6C 0x6F 0x61 0x64).

This makes the default identifiers for the PDOs active again.

Emergency Identifier

Index	Subindex	Name	Type	Attribute	Mapping	Default value	Meaning
0x1014	0	COB-ID Emergency	Unsigned32	rw	N	0x00000080, + NodeID	Identifier of the emergency telegram

The bottom 11 bits of the 32-bit value contain the identifier (0x80=128dec). The MSBit can be used to set whether the device sends (1) the emergency telegram or not (0).

Alternatively, the bus node's diagnostic function can also be switched off using the *Device diagnostics* bit in the K-bus configuration (see object 0x4500).

Consumer Heartbeat Time

Index	Subindex	Name	Type	Attribute	Mapping	Default value	Meaning
0x1016	0	Number of elements	Unsigned8	ro	N	2	The consumer heartbeat time describes the expected heartbeat cycle time and the node ID of the monitored node
	1	Consumer Heartbeat Time	Unsigned32	rw	N	0	Watchdog time in ms and node ID of the monitored node

The 32-bit value is used as follows:

MSB		LSB
Bit 31...24	Bit 23...16	Bit 15...0
Reserved (0)	Node-ID (Unsigned8)	heartbeat time in ms (Unsigned16)

The monitored identifier is derived from the node ID through the default identifier distribution: Guard ID = 0x700 + node ID.

As is usual in CANopen, the LSB is transferred first, followed by the MSB.

Producer Heartbeat Time

Index	Subindex	Name	Type	Attribute	Mapping	Default value	Meaning
0x1017	0	Producer Heartbeat Time	Unsigned16	rw	N	0	Interval in ms between two transmitted heartbeat telegrams

Device identifier (identity object)

Index	Subindex	Name	Type	Attribute	Mapping	Default value	Meaning
0x1018	0	Identity Object: Number of elements	Unsigned8	ro	N	4	The identity object contains general information about the type and version of the device.
	1	Vendor ID	Unsigned32	ro	N	0x00000002	Manufacturer identifier. Beckhoff has vendor ID 2
	2	Product Code	Unsigned32	ro	N	Depends on the product	Device identifier
	3	Revision Number	Unsigned32	ro	N	-	Version number
	4	Serial Number	Unsigned32	ro	N	-	Date of manufacture Low word, high byte: calendar week (dec), low word, low byte: calendar year

Product	Product Code
BK5120	0x11400
BK5110	0x113F6
LC5100	0x113EC
IPwxyz-B510	0x2wxyz
IL2301-B510	0x2008FD

Server SDO parameters

Index	Subindex	Name	Type	Attribute	Mapping	Default value	Meaning
0x1200	0	Number of elements	Unsigned8	ro	N	2	Communication parameters of the server SDO. Subindex 0: Number of following parameters
	1	COB-ID Client ->Server	Unsigned32	ro	N	0x000006xy, xy=Node-ID	COB-ID RxSDO (Client -> Server)
	2	COB-ID Server ->Client	Unsigned32	ro	N	0x00000580 + Node-ID	COB-ID TxSDO (Client -> Server)

This is contained in the object directory for reasons of backwards compatibility.

Communication parameter 1 RxPDO

Index	Subindex	Name	Type	Attribute	Mapping	Default value	Meaning
0x1400	0	Number of elements	Unsigned8	ro	N	5	Communication parameters for the first receive PDO. Subindex 0: Number of following parameters
	1	COB-ID	Unsigned32	rw	N	0x000002xy, xy=Node-ID	COB-ID (Communication Object Identifier) RxPDO1
	2	Transmission Type	Unsigned8	rw	N	255	Transmission type of the PDO
	3	Inhibit Time	Unsigned16	rw	N	0	Present for reasons of backwards compatibility, but not used in the RxPDO.
	4	CMS Priority Group	Unsigned8	rw	N	-	Present for reasons of backwards compatibility, but not used.
	5	Event Timer	Unsigned16	rw	N	0	Event-Timer. Watchdog time defined for monitoring reception of the PDO.

Subindex 1 (COB-ID): The bottom 11 bits of the 32 bit value (bits 0-10) contain the CAN identifier. The MSB (bit 31) indicates whether the PDO exists currently (0) or not (1). Bit 30 indicates whether an RTR access to this PDO is permissible (0) or not (1). Changing the identifier (bits 0-10) is not allowed while the object exists (bit 31=0). Subindex 2 contains the transmission type (see introduction to PDOs).

Communication parameters for the 2nd RxPDO

Index	Subindex	Name	Type	Attribute	Mapping	Default value	Meaning
0x1401	0	Number of elements	Unsigned8	ro	N	5	Communication parameter for the second receive PDO.
	1	COB-ID	Unsigned32	rw	N	0x000003xy, xy=Node-ID	COB-ID (Communication Object Identifier) RxPDO2
	2	Transmission Type	Unsigned8	rw	N	255	Transmission type of the PDO
	3	Inhibit Time	Unsigned16	rw	N	0	Present for reasons of backwards compatibility, but not used in the RxPDO.
	4	CMS Priority Group	Unsigned8	rw	N	-	Present for reasons of backwards compatibility, but not used.
	5	Event Timer	Unsigned16	rw	N	0	Event-Timer. Watchdog time defined for monitoring reception of the PDO.

Communication parameters for the 3rd RxPDO

Index	Subindex	Name	Type	Attribute	Mapping	Default value	Meaning
0x1402	0	Number of elements	Unsigned8	ro	N	5	Communication parameter for the third receive PDO.
	1	COB-ID	Unsigned32	rw	N	0x000004xy, xy=Node-ID	COB-ID (Communication Object Identifier) RxPDO3
	2	Transmission Type	Unsigned8	rw	N	255	Transmission type of the PDO
	3	Inhibit Time	Unsigned16	rw	N	0	Present for reasons of backwards compatibility, but not used in the RxPDO.
	4	CMS Priority Group	Unsigned8	rw	N	-	Present for reasons of backwards compatibility, but not used.
	5	Event Timer	Unsigned16	rw	N	0	Event-Timer. Watchdog time defined for monitoring reception of the PDO.

Communication parameters for the 4th RxPDO

Index	Subindex	Name	Type	Attribute	Mapping	Default value	Meaning
0x1403	0	Number of elements	Unsigned8	ro	N	5	Communication parameters for the fourth receive PDO.
	1	COB-ID	Unsigned32	rw	N	0x000005xy, xy=Node-ID	COB-ID (Communication Object Identifier) RxPDO4
	2	Transmission Type	Unsigned8	rw	N	255	Transmission type of the PDO
	3	Inhibit Time	Unsigned16	rw	N	0	Present for reasons of backwards compatibility, but not used in the RxPDO.
	4	CMS Priority Group	Unsigned8	rw	N	-	Present for reasons of backwards compatibility, but not used.
	5	Event Timer	Unsigned16	rw	N	0	Event-Timer. Watchdog time defined for monitoring reception of the PDO.

Communication parameters 5th - 16th RxPDO

Index	Subindex	Name	Type	Attribute	Mapping	Default value	Meaning
0x1404 - 0x140F (depending on the device type)	0	Number of elements	Unsigned8	ro	N	5	Communication parameter for the 5 th to 16 th receive PDOs.
	1	COB-ID	Unsigned32	rw	N	0x80000000	COB-ID (Communication Object Identifier) RxPDO5...16
	2	Transmission Type	Unsigned8	rw	N	255	Transmission type of the PDO
	3	Inhibit Time	Unsigned16	rw	N	0	Present for reasons of backwards compatibility, but not used in the RxPDO.
	4	CMS Priority Group	Unsigned8	rw	N	-	Present for reasons of backwards compatibility, but not used.
	5	Event Timer	Unsigned16	rw	N	0	Event-Timer. Watchdog time defined for monitoring reception of the PDO.

The number of RxPDOs for each bus node type can be found in the technical data.

Mapping parameter 1st RxPDO

Index	Subindex	Name	Type	Attribute	Mapping	Default value	Meaning
0x1600	0	Number of elements	Unsigned8	rw	N	Depending on type and fittings	Mapping parameter of the first receive PDO; subindex 0: Number of mapped objects.
	1	1 st mapped object	Unsigned32	rw	N	0x62000108	1 st mapped application object (2 bytes index, 1 byte subindex, 1 byte bit width)
	2	2 nd mapped object	Unsigned32	rw	N	0x62000208	2 nd mapped application object (2 bytes index, 1 byte subindex, 1 byte bit width)

	8	8 th mapped object	Unsigned32	rw	N	0x62000808	8 th mapped application object (2 bytes index, 1 byte subindex, 1 byte bit width)

The first receive PDO (RxPDO1) is provided by default for digital output data. Depending on the number of outputs inserted, the necessary length of the PDO is automatically determined, and the corresponding objects are mapped. Since the digital outputs are organized in bytes, the length of the PDO in bytes can be found directly at subindex 0.

Changes to the mapping

The following sequence must be observed in order to change the mapping (specified as from CANopen, version 4):

1. Delete PDO (set bit 31 in the identifier entry (subindex 1) of the communication parameters to 1)
2. Deactivate mapping (set subindex 0 of the mapping entry to 0)

3. Change mapping entries (subindices 1..8)
4. Activate mapping (set subindex 0 of the mapping entry to the correct number of mapped objects)
5. Create PDO (set bit 31 in the identifier entry (subindex 1) of the communication parameters to 0)

Mapping parameter 2nd RxPDO

Index	Subindex	Name	Type	At-tribut e	Map-ping	Default value	Meaning
0x1601	0	Number of elements	Unsigned8	rw	N	Depending on type and fittings	Mapping parameter of the second receive PDO; subindex 0: Number of mapped objects.
	1	1 st mapped object	Unsigned32	rw	N	0x64110110	1 st mapped application object (2 bytes index, 1 byte subindex, 1 byte bit width)
	2	2 nd mapped object	Unsigned32	rw	N	0x64110210	2 nd mapped application object (2 bytes index, 1 byte subindex, 1 byte bit width)

	8	8 th mapped object	Unsigned32	rw	N	0x00000000	8 th mapped application object (2 bytes index, 1 byte subindex, 1 byte bit width)

The second receive PDO (RxPDO2) is provided by default for analog outputs. Depending on the number of outputs inserted, the necessary length of the PDO is automatically determined, and the corresponding objects are mapped. Since the analog outputs are organized in words, the length of the PDO in bytes can be found directly at subindex 0.

A specific sequence must be observed in order to change the mapping (see object index 0x1600).

Mapping-parameters 3rd - 16th RxPDO

Index	Subindex	Name	Type	At-tribut e	Map-ping	Default value	Meaning
0x1602-0x160F (depending on the device type)	0	Number of elements	Unsigned8	rw	N	Depending on type and fittings	Mapping parameters of 3 rd - 16 th receive PDOs; subindex 3: Number of mapped objects.
	1	1 st mapped object	Unsigned32	rw	N	0x00000000 (see text)	1 st mapped application object (2 bytes index, 1 byte subindex, 1 byte bit width)
	2	2 nd mapped object	Unsigned32	rw	N	0x00000000 (see text)	2 nd mapped application object (2 bytes index, 1 byte subindex, 1 byte bit width)

	8	8 th mapped object	Unsigned32	rw	N	0x00000000 (see text)	8 th mapped application object (2 bytes index, 1 byte subindex, 1 byte bit width)

The 3rd to 16th receive PDOs (RxPDO3ff) are automatically given a default mapping by the bus node depending on the attached terminals (or depending on the extension modules). The procedure is described in the section on PDO Mapping.

A specific sequence must be observed in order to change the mapping (see object index 0x1600).

● Beckhoff Default Mapping

I DS401 V2 specifies analog input and/or output data as the default mapping for PDOs 3 and 4. This corresponds to Beckhoff's default mapping when less than 65 digital inputs or outputs are present. In order to ensure backwards compatibility, the Beckhoff default mapping is retained - the mapping behavior of the devices therefore corresponds to DS401 V1, where in all other respects they accord with DS401 V2.

Communication parameter 1st RxPDO

Index	Subindex	Name	Type	Attribute	Mapping	Default value	Meaning
0x1800	0	Number of elements	Unsigned8	ro	N	5	Communication parameters for the first transmit PDO. Subindex 0: Number of following parameters
	1	COB-ID	Unsigned32	rw	N	0x00000180 + Node-ID	COB-ID (Communication Object Identifier) Tx-PDO1
	2	Transmission Type	Unsigned8	rw	N	255	Transmission type of the PDO
	3	Inhibit Time	Unsigned16	rw	N	0	Repetition delay [value x 100 µs]
	4	CMS Priority Group	Unsigned8	rw	N	-	Present for reasons of backwards compatibility, but not used.
5	Event Timer	Unsigned16	rw	N	0	Event-Timer	

Subindex 1 (COB-ID): The bottom 11 bits of the 32-bit value (bits 0-10) contain the CAN identifier. The MSB (bit 31) indicates whether the PDO exists currently (0) or not (1). Bit 30 indicates whether an RTR access to this PDO is permissible (0) or not (1). Changing the identifier (bits 0-10) is not allowed while the object exists (bit 31=0). Subindex 2 contains the transmission type, subindex 3 the repetition delay between two PDOs of the same type, while subindex 5 contains the event timer. Subindex 4 is retained for reasons of compatibility, but is not used. (See also Introduction to PDOs.)

Communication parameters for the 2nd RxPDO

Index	Subindex	Name	Type	Attribute	Mapping	Default value	Meaning
0x1801	0	Number of elements	Unsigned8	ro	N	5	Communication parameters for the second transmit PDO. Subindex 0: Number of following parameters
	1	COB-ID	Unsigned32	rw	N	0x00000280 + Node-ID	COB-ID (Communication Object Identifier) Tx-PDO1
	2	Transmission Type	Unsigned8	rw	N	255	Transmission type of the PDO
	3	Inhibit Time	Unsigned16	rw	N	0	Repetition delay [value x 100 µs]
	4	CMS Priority Group	Unsigned8	rw	N	-	Present for reasons of backwards compatibility, but not used.
5	Event Timer	Unsigned16	rw	N	0	Event-Timer	

The second transmit PDO is provided by default for analog inputs, and is configured for event-driven transmission (transmission type 255). Event-driven mode must first be activated (see object 0x6423), otherwise the inputs can only be interrogated (polled) by Remote Transmission Request (RTR).

Communication parameters for the 3rd RxPDO

Index	Subindex	Name	Type	Attribute	Mapping	Default value	Meaning
0x1802	0	Number of elements	Unsigned8	ro	N	5	Communication parameters for the third transmit PDO. Subindex 0: Number of following parameters
	1	COB-ID	Unsigned32	rw	N	0x00000380 + Node-ID	COB-ID (Communication Object Identifier) Tx-PDO1
	2	Transmission Type	Unsigned8	rw	N	255	Transmission type of the PDO
	3	Inhibit Time	Unsigned16	rw	N	0	Repetition delay [value x 100 µs]
	4	CMS Priority Group	Unsigned8	rw	N	-	Present for reasons of backwards compatibility, but not used.
5	Event Timer	Unsigned16	rw	N	0	Event-Timer	

The third transmit PDO contains analog input data as a rule (see Mapping). It is configured for event-driven transmission (transmission type 255). Event-driven mode must first be activated (see object 0x6423), otherwise the inputs can only be interrogated (polled) by Remote Transmission Request (RTR).

Communication parameters for the 4th RxPDO

Index	Subindex	Name	Type	Attribute	Mapping	Default value	Meaning
0x1803	0	Number of elements	Unsigned8	ro	N	5	Communication parameters for the fourth transmit PDO. Subindex 0: Number of following parameters
	1	COB-ID	Unsigned32	rw	N	0x00000480 + Node-ID	COB-ID (Communication Object Identifier) Tx-PDO1
	2	Transmission Type	Unsigned8	rw	N	255	Transmission type of the PDO
	3	Inhibit Time	Unsigned16	rw	N	0	Repetition delay [value x 100 µs]
	4	CMS Priority Group	Unsigned8	rw	N	-	Present for reasons of backwards compatibility, but not used.
	5	Event Timer	Unsigned16	rw	N	0	Event-Timer

The fourth transmit PDO contains analog input data as a rule (see Mapping). It is configured for event-driven transmission (transmission type 255). Event-driven mode must first be activated (see object 0x6423), otherwise the inputs can only be interrogated (polled) by Remote Transmission Request (RTR).

Communication parameters 5th - 16th RxPDO

Index	Subindex	Name	Type	Attribute	Mapping	Default value	Meaning
0x1804-0x180F (depending on the device type)	0	Number of elements	Unsigned8	ro	N	5	Communication parameters for the 5 th - 16 th transmit PDOs. Subindex 0: Number of following parameters
	1	COB-ID	Unsigned32	rw	N	0x00000000	COB-ID (Communication Object Identifier) Tx-PDO1
	2	Transmission Type	Unsigned8	rw	N	255	Transmission type of the PDO
	3	Inhibit Time	Unsigned16	rw	N	0	Repetition delay [value x 100 µs]
	4	CMS Priority Group	Unsigned8	rw	N	-	Present for reasons of backwards compatibility, but not used.
	5	Event Timer	Unsigned16	rw	N	0	Event-Timer

Mapping 1st TxPDO

Index	Subindex	Name	Type	Attribute	Mapping	Default value	Meaning
0x1A00	0	Number of elements	Unsigned8	rw	N	Depending on type and fittings	Mapping parameter of the first transmit PDO; subindex 0: Number of mapped objects.
	1	1 st mapped object	Unsigned32	rw	N	0x60000108	1 st mapped application object (2 bytes index, 1 byte subindex, 1 byte bit width)
	2	2 nd mapped object	Unsigned32	rw	N	0x60000208	2 nd mapped application object (2 bytes index, 1 byte subindex, 1 byte bit width)

	8	8 th mapped object	Unsigned32	rw	N	0x60000808	8 th mapped application object (2 bytes index, 1 byte subindex, 1 byte bit width)

The first transmit PDO (TxPDO1) is provided by default for digital input data. Depending on the number of inputs inserted, the necessary length of the PDO is automatically determined, and the corresponding objects are mapped. Since the digital inputs are organized in bytes, the length of the PDO in bytes can be found directly at subindex 0.

A specific sequence must be observed in order to change the mapping (see object index 0x1600).

Mapping 2nd TxPDO

Index	Subindex	Name	Type	Attribute	Mapping	Default value	Meaning
0x1A01	0	Number of elements	Unsigned8	rw	N	Depending on type and fittings	Mapping parameter of the second transmit PDO; subindex 0: Number of mapped objects.
	1	1 st mapped object	Unsigned32	rw	N	0x64010110	1 st mapped application object (2 bytes index, 1 byte subindex, 1 byte bit width)
	2	2 nd mapped object	Unsigned32	rw	N	0x64010210	2 nd mapped application object (2 bytes index, 1 byte subindex, 1 byte bit width)

	8	8 th mapped object	Unsigned32	rw	N		8 th mapped application object (2 bytes index, 1 byte subindex, 1 byte bit width)

The second transmit PDO (TxPDO2) is provided by default for analog input data. Depending on the number of inputs inserted, the necessary length of the PDO is automatically determined, and the corresponding objects are mapped. Since the analog inputs are organized in words, the length of the PDO in bytes can be found directly at subindex 0.

A specific sequence must be observed in order to change the mapping (see object index 0x1600).

Mapping 3rd - 16th TxPDO

Index	Subindex	Name	Type	Attribute	Mapping	Default value	Meaning
0x1A02-0x1A0F (depending on the device type)	0	Number of elements	Unsigned8	rw	N	Depending on type and fittings	Mapping parameters of 3 rd - 16 th transmit PDOs; subindex 3: Number of mapped objects.
	1	1 st mapped object	Unsigned32	rw	N	0x00000000 (see text)	1 st mapped application object (2 bytes index, 1 byte subindex, 1 byte bit width)
	2	2 nd mapped object	Unsigned32	rw	N	0x00000000 (see text)	2 nd mapped application object (2 bytes index, 1 byte subindex, 1 byte bit width)

	8	8 th mapped object	Unsigned32	rw	N	0x00000000 (see text)	8 th mapped application object (2 bytes index, 1 byte subindex, 1 byte bit width)

The 3rd to 16th transmit PDOs (TxPDO3ff) are automatically given a default mapping by the bus node depending on the attached terminals (or depending on the extension modules). The procedure is described in the section on PDO Mapping.

A specific sequence must be observed in order to change the mapping (see object index 0x1600).

● Beckhoff Default Mapping

I DS401 V2 specifies analog input and/or output data as the default mapping for PDOs 3+4. This corresponds to Beckhoff's default mapping when less than 65 digital inputs or outputs are present. In order to ensure backwards compatibility, the Beckhoff default mapping is retained - the mapping behavior of the devices therefore corresponds to DS401 V1, where in all other respects they accord with DS401 V2.

For the sake of completeness, the following object entries are also contained in the object directory (and therefore also in the eds files):

Index	Meaning
0x2000	Digital inputs (function identical to object 0x6000)
0x2100	Digital outputs (function identical with object 0x6100)
0x2200	1-byte special terminals, inputs (at present no terminals corresponding to this type are included in the product range)
0x2300	1-byte special terminals, outputs (at present no terminals corresponding to this type are included in the product range)
0x2400	2-byte special terminals, inputs (at present no terminals corresponding to this type are included in the product range)
0x2500	2-byte special terminals, outputs (at present no terminals corresponding to this type are included in the product range)
0x2E00	7-byte special terminals, inputs (at present no terminals corresponding to this type are included in the product range)
0x2F00	7-byte special terminals, outputs (at present no terminals corresponding to this type are included in the product range)

3-byte special terminals, input data

Index	Subindex	Name	Type	Attribute	Mapping	Default value	Meaning
0x2600	0	Number of elements	Unsigned8	ro	N	Depending on type and fittings	Number of available 3-byte special channels, inputs
	1	1st input block	Unsigned24	ro	Y	0x000000	1 st input channel

	0X80	128 th input block	Unsigned24	ro	Y	0x000000	128 th input channel

Example for special terminals with 3 bytes of input data as default setting: KL2502 (PWM outputs, 2 x 3 bytes)

3-byte special terminals, output data

Index	Subindex	Name	Type	Attribute	Mapping	Default value	Meaning
0x2700	0	Number of elements	Unsigned8	ro	N	Depending on type and fittings	Number of available 3-byte special channels, outputs
	1	1st output block	Unsigned24	rww	Y	0x000000	1 st output channel

	0X80	128 th output block	Unsigned24	rww	Y	0x000000	128 th output channel

Example for special terminals with 3 bytes of output data as default setting: KL2502 (PWM outputs, 2 x 3 bytes)

4-byte special terminals, input data

Index	Subindex	Name	Type	Attribute	Mapping	Default value	Meaning
0x2800	0	Number of elements	Unsigned8	ro	N	Depending on type and fittings	Number of available 4-byte special channels, inputs
	1	1st input block	Unsigned32	ro	Y	0x00000000	1 st input channel

	0X80	128 th input block	Unsigned32	ro	Y	0x00000000	128 th input channel

Examples for special terminals with 4 bytes of input data as default setting: KL5001, KL6001, KL6021, KL6051

4-byte special terminals, output data

Index	Subindex	Name	Type	Attribute	Mapping	Default value	Meaning
0x2900	0	Number of elements	Unsigned8	ro	N	Depending on type and fittings	Number of available 4-byte special channels, outputs
	1	1st output block	Unsigned32	rww	Y	0x00000000	1 st output channel

	0X80	128 th output block	Unsigned32	rww	Y	0x00000000	128 th output channel

Examples for special terminals with 4 bytes of output data as default setting: KL5001, KL6001, KL6021, KL6051

5-byte special terminals, input data

Index	Subindex	Name	Type	Attribute	Mapping	Default value	Meaning
0x2A00	0	Number of elements	Unsigned8	ro	N	Depending on type and fittings	Number of available 5-byte special channels, inputs
	1	1st input block	Unsigned40	ro	Y	0x000000000000	1 st input channel

	0X40	64 th input block	Unsigned40	ro	Y	0x000000000000	64 th input channel

Example for special terminals with 5 bytes of input data as default setting: KL1501

5-byte special terminals, output data

Index	Subindex	Name	Type	Attribute	Mapping	Default value	Meaning
0x2B00	0	Number of elements	Unsigned8	ro	N	Depending on type and fittings	Number of available 5-byte special channels, outputs
	1	1st output block	Unsigned40	rww	Y	0x000000000000	1 st output channel

	0X40	64 th output block	Unsigned40	rww	Y	0x000000000000	64 th output channel

Example for special terminals with 5 bytes of output data as default setting: KL1501

6-byte special terminals, input data

Index	Subindex	Name	Type	Attribute	Mapping	Default value	Meaning
0x2C00	0	Number of elements	Unsigned8	ro	N	Depending on type and fittings	Number of available 6-byte special channels, inputs
	1	1st input block	Unsigned48	ro	Y	0x000000000000	1 st input channel

	0X40	64 th input block	Unsigned48	ro	Y	0x000000000000	64 th input channel

Example for special terminals with 6 bytes of input data as default setting: KL5051, KL5101, KL5111

6-byte special terminals, output data

Index	Subindex	Name	Type	Attribute	Mapping	Default value	Meaning
0x2D00	0	Number of elements	Unsigned8	ro	N	Depending on type and fittings	Number of available 6-byte special channels, outputs
	1	1st output block	Unsigned48	rww	Y	0x000000000000	1 st output channel

	0X40	64 th output block	Unsigned48	rww	Y	0x000000000000	64 th output channel

Example for special terminals with 6 bytes of output data as default setting: KL5051, KL5101, KL5111

8-byte special terminals, input data

Index	Subindex	Name	Type	Attribute	Mapping	Default value	Meaning
0x3000	0	Number of elements	Unsigned8	ro	N	Depending on type and fittings	Number of available 6-byte special channels, inputs
	1	1st input block	Unsigned64	ro	Y	0x0000000000	1 st input channel

	0x40	64 th input block	Unsigned64	ro	Y	0x0000000000	64 th input channel

Example for special terminals with 8 bytes of input data: KL5101 (with word alignment, not in the default setting)

8-byte special terminals, output data

Index	Subindex	Name	Type	Attribute	Mapping	Default value	Meaning
0x3100	0	Number of elements	Unsigned8	ro	N	Depending on type and fittings	Number of available 6-byte special channels, outputs
	1	1st output block	Unsigned64	rww	Y	0x0000000000	1 st output channel

	0x40	64 th output block	Unsigned64	rww	Y	0x0000000000	64 th output channel

Example for special terminals with 8 bytes of output data: KL5101 (with word alignment, not in the default setting)

Bus node register communication

Index	Subindex	Name	Type	Attribute	Mapping	Default value	Meaning
0x4500	0	Register Access	Unsigned32	rw	N	none	Access to internal bus node registers

The 32 bit value is composed as follows:

MSB			LSB
Access (bit 7) + table number (bit 6...0)	Register number	High byte register value	Low byte register value
[0..1] + [0...0x7F]	[0...0xFF]	[0...0xFF]	[0...0xFF]

As is usual in CANopen, the LSB is transferred first, followed by the MSB.

Accessing index 0x4500 allows any registers in the bus station to be written or read. The channel number and the register are addressed here with a 32 bit data word.

Reading the register value

The coupler must first be informed of which register is to be read. To this end an SDO write access to the corresponding index/subindex combination is required with:

- table number (access bit=0) in byte 3
- register address in byte 2 of the data value 32 bit.

Bytes 1 and 0 are not evaluated if the access bit (MSB of byte 3) equals 0. The register value can then be read with the same combination of index and subindex.

After the writing of the register address to be read, the coupler sets the access bit to 1 until the correct value is available. Thus an SDO read access must check that the table number lies in the range from 0...0x7F.

An access error during register communication is indicated by the corresponding return value in the SDO protocol (see the SDO section, Breakdown of parameter communication).

An example of reading register values

It is necessary to determine which baud rate index has been assigned to switch setting 1,1 (DIP 7,8). (See the section covering *Network addresses and baud rates*). To do this, the value in table 100, register 3, must be read. This means that the following SDO telegrams must be sent:

Write access (download request) to index 4500, subindex 0 with data value 32 bit 0x64 03 00 00.

Id=0x600+Node-ID DLC=8; Data=23 00 45 00 00 00 03 64

Then a read access (upload request) to the same index/subindex. The data value sent here is irrelevant (00 is used here).

Id=0x600+Node-ID DLC=8; Data=40 00 45 00 00 00 00 00

The coupler responds with the upload response telegram:

Id=0x580+Node-ID DLC=8; Data=43 00 45 00 04 00 03 64

This tells us that the value contained in this register is 4, and this baud rate index corresponds to 125 kbit/s (the default value).

Writing register values

SDO write access to the corresponding combination of index and subindex with:

- table number + 0x80 (access bit = 1) in byte 3
- register address in byte 2
- high byte register value in byte 1
- low byte register value in byte 0 of the 32-bit data value.

Remove coupler write protection

Before the registers of the Bus Coupler can be written, the write protection must first be removed. In order to do this, the following values must be written in the given sequence to the corresponding registers:

Step	Table	Register	Value	Corresponding SDO download value (0x4500/0)
1.	99	2	45054 (0xAFFE)	0xE3 02 AF FE (0xE3=0x63(=99)+0x80)
2.	99	1	1 (0x0001)	0xE3 01 00 01
3.	99	0	257 (0x0101)	0xE3 00 01 01

Remove coupler write protection (CAN representation)

In order to remove the coupler write protection, the following SDO telegrams (download requests) must thus be sent to the coupler:

Id=0x600+Node-ID DLC=8; Data=23 00 45 00 FE AF 02 E3

Id=0x600+Node-ID DLC=8; Data=23 00 45 00 01 00 01 E3

Id=0x600+Node-ID DLC=8; Data=23 00 45 00 01 01 00 E3

An example of writing register values

After the write protection has been removed, the baud rate index for DIP switch setting 1,1 is to be set to the value 7. This will assign a baud rate of 20 kbaud to this switch setting.

This requires the value 7 to be written into table 100, register 3. This is done with an SDO write access (download request) to index 0x4500, subindex 0 with the 32 bit value E4 03 00 07 (0xE4 = 0x64+0x80):

Id=0x600+Node-ID DLC=8; Data=23 00 45 00 07 00 03 E4

Identify terminals

The identifier of the coupler (or of the bus station) and of the attached Bus Terminals can be read from the Bus Coupler's table 9. Register 0 then contains the identifier of the Bus Coupler itself, register 1 the identifier of the first terminal and register n the identification of the nth terminal:

Table number	Register number	Description	Value range
9	0	Bus station identifier	0 - 65535
9	1-255	Identifier of the extension module/bus terminal	0 - 65535

The Bus Coupler description in register number 0 contains 5120 = 0x1400 for the BK5120, 5110 = 0x13F6 for the BK5110 and 5100 = 0x13EC for the LC5100. For the Fieldbus Box modules, register 0 contains the ID 510dec = 0x1FE or 518dec = 0x206.

In the case of analog and special terminals, the terminal identifier (dec) is contained in the extension module identifier or the terminal description.

Example: If a KL3042 is connected as the third terminal, register 3 is assigned the value 3042_{dec} (0x0BE2).

The following bit identifier is used for digital terminals:

MSB								LSB							
1	s6	s5	s4	s3	s2	s1	s0	0	0	0	0	0	0	a	e

s6...s1: Data width in bits; a=1: Output terminal; e=1: Input terminal

This ID leads to the following terminal descriptions:

Identifier terminals	Meaning
0x8201	2 bit digital input terminal, e.g. KL1002, KL1052, KI9110, KL9260
0x8202	2 bit digital output terminal, e.g. KL2034, KL2612, KL2702
0x8401	4 bit digital input terminal, e.g. KL1104, KL1124, KL1194
0x8402	4 bit digital output terminal, e.g. KL2124, KL2134, KL2184
0x8403	4 bit digital in/output terminal, e.g. KL2212

and the following ID for extension box modules:

ID of extension box modules	Meaning
0x000A	4 bit input and 4 bit output module
0x0011	8 bit input and 8 bit output module
0x0014	8 bit digital input module
0x0015	8 bit digital output module

General coupler configuration (table 0)

Table 0 of the Bus Coupler contains the data for the general coupler configuration. It is not, as a general rule, necessary to change this; however, for special applications it is possible to change the settings using the KS2000 configuration software, or through direct access via register communication. The write protection must first be removed in order to do this (see above).

The relevant register entries are described below:

K-bus configuration

Table 0, register 2 contains the K-bus configuration and is coded as follows (default value: 0x0006):

MSB								LSB								
0	0	0	0	0	0	0	0	0	0	0	0	0	0	D	G	A

A: Auto-reset

If there is a K-bus error, attempts are made cyclically to start the K-bus up again through a reset. If emergency telegrams and guarding are not evaluated, activation of auto-reset can lead to output and input information being lost without that loss being noticed.

0: No auto-reset (default)

1: Auto-reset active

G: Device diagnostics

Message (via emergency), e.g. that
 - open circuit at current inputs (with diagnostics)
 - 10 V exceeded at 1-10V input terminal

0: Device diagnostics switched off
 1: Device diagnostics active (default)

D: Diagnostic data

Show digital terminals into the process image (e.g. KL2212). This flag is only evaluated when device diagnostics is active (see above).

0: Do not show
 1: Show (default)

Process image description

Table 0, register 3 contains the process image description and is coded as follows (default value: 0x0903):

MSB								LSB							
0	0	0	0	k1	k0	f1	f0	0	0	a	0	d	k	1	1

k0...k1: Response to K-bus error

0,2: Inputs remain unchanged (default = 2);
 1: Set inputs to 0 (TxPDO with zeros is sent)

f0...f1: Response to fieldbus error

0: Stop the K-bus cycles, watchdog in the terminals triggers, fault output values become active. The old output values are initially set during a restart.
 1: Set outputs to 0, then stop the K-bus cycles (default). 2: Outputs remain unchanged.

a: Word alignment of analog and special terminals

0: no alignment (default)
 1: Map data to word boundaries (process data always starts on an even address in the PDO)

d: Data format for complex terminals (analog and special terminals)

0: Intel format (default)
 1: Motorola format

k: Evaluation of complex terminals (analog and special terminals)

0: only user data (default)
 1: Full evaluation (note: analog channels then, for example, need 3 input and 3 output bytes instead of 2 input bytes; instead of 4 channels per PDO, 2 channels require a RxPDO and a TxPDO)

Bus Terminal / Extension Box register communication

Index	Subindex	Name	Type	Attribute	Mapping	Default value	Meaning
0x4501	0	Access Terminal Register	Unsigned8	ro	N	none	Index 0x4501 allows access to all the registers in the bus terminal or extension module. Subindex 0 contains the number of attached bus terminals.
	1	Access Reg. Terminal 1	Unsigned32	rw	N	none	Access to bus terminal or extension module register 1

	0XFE	Access Reg. Terminal 254	Unsigned32	rw	N	none	Access to bus terminal or extension module register 254

The 32 bit value is composed as follows:

MSB			LSB
Access (bit 7) + channel number (bit 6..0)	Register number	High byte register value	Low byte register value
[0..1] + [0...0x7F]	[0...0xFF]	[0...0xFF]	[0...0xFF]

As is usual in CANopen, the LSB is transferred first, followed by the MSB.

Accessing index 0x4501 allows the user registers in the bus terminal or extension module to be written or read. The modules have a set of registers for each input or output channel. The modules are addressed by means of the subindex; the channel number and register are addressed in the 32-bit data value. Channel number 0 corresponds here to the first channel, 1 to the second channel, and so forth.

Reading the register value

The coupler must first be informed of which register is to be read. This requires an SDO write access to the appropriate index/subindex combination, with:

channel number (access bit = 0) in byte 3

register address in byte 2 of the 32-bit data value.

Bytes 1 and 0 are not evaluated if the access bit (MSB of byte 3) equals 0. The register value can then be read with the same combination of index and subindex.

After the writing of the register address to be read, the coupler sets the access bit to 1 until the correct value is available. Thus an SDO read access must check that the table number lies in the range from 0...0x7F.

An access error during register communication is indicated by the corresponding return value in the SDO protocol (see the SDO section, Breakdown of parameter communication).

An example of reading register values

The thermocouple type to which the second input channel of a KL3202 Thermocouple Input Terminal has been set is to be determined. This requires feature register 32 to be read. The terminal is located in the fifth slot, next to the Bus Coupler. This means that the following SDO telegrams must be sent:

Write access (download request) to index 0x4501, subindex 5 with 32 bit data value 01 20 00 00 (0x01 = 2nd channel, 00x20 = register 32)

Id=0x600+Node-ID DLC=8; Data=23 01 45 05 00 00 20 01

Then a read access (upload request) to the same index/subindex. The data value sent here is irrelevant (0x00 is used here).

Id=0x600+Node-ID DLC=8; Data=40 01 45 05 00 00 00 00

The coupler responds with the upload response telegram:

ID=0x580+node ID DLC=8; data=43 01 45 05 06 31 20 01

This means that the feature register contains the value 31 06. The upper 4 bits indicate the thermocouple type. Their value here is 3, which means that PT500 is the type that has been set for this channel (see the KL3202 documentation).

Writing register values

SDO write access to the corresponding index/subindex combination with:

- channel number + 0x80 (access bit=1) in byte 3
- register address in byte 2
- high byte register value in byte 1
- low byte register value in byte 0 of the 32-bit data value.

NOTE

Check the value that was written

If the write protection is not removed (as a result, for instance, of a faulty codeword), then although a write access to the terminal register will be confirmed (SDO download response), the value is not in fact entered into the register. It is therefore recommended that the value is read back after writing and compared.

Remove terminal write protection

Before the user registers in the Bus Terminal (register 32-xx, depending on terminal type or extension module) can be written to, it is first necessary for write protection to be removed. The following codeword is written for this purpose into register 31 of the channel concerned:

Write protection	Channel	Register	Value	corresponding SDO download value (0x4500/0)
	1,2, 3 or 4	31 (0x1F)	4661 (0x1235)	8y 1F 12 35 (y = channel number)

Remove terminal write protection (CAN representation)

In order to remove the terminal's write protection, the following SDO telegram must thus be sent to the coupler:

Id=600 + Node-ID DLC=8; Data=23 01 45 xx 35 12 1F 8y

where xx is the terminal's slot, and y indicates the channel.

An example of removing write protection

Suppose that a KL3202 Thermocouple Input Terminal is inserted into slot 5 of a BK5120 that has node address 3, then the write protection for the first channel can be removed as follows:

Id=0x603 DLC=8; Data=23 01 45 05 35 12 1F 80

The following telegram is sent for the second channel:

Id=0x603 DLC=8; Data=23 01 45 05 35 12 1F 81

An example of writing register values

The type of thermocouple attached to the second channel of the KL3202 Terminal in slot 5 is now to be changed to PT1000. For this purpose, the value 2 must be written into the upper 4 bits (the upper nibble) of the feature register. It is assumed that the default values are to be supplied for all the other bits in the feature register. Once the write protection has been removed, use SDO write access (download request) to write the following 32-bit value to index 0x4501, subindex 05: 81 20 21 06 (0x81=01+0x80; 0x20=32;0x2106 = register value).

The corresponding telegram on the bus looks like this:

Id=0x600+Node-ID DLC=8; Data=23 01 45 05 06 21 20 81

Activate PDOs

Index	Subindex	Name	Type	At-tribut e	Map-ping	Default value	Meaning
0x5500	0	Activate PDO De-faults	Unsigned32	rw	N	0x00000000	sets PDO communication parameters for PDOs 2...11

CANopen defines default identifiers for 4 transmit (Tx) and receive (Rx) PDOs, all other PDOs being initially deactivated after the nodes have started up. Index 0x5500 can activate all the PDOs that, in accordance with the terminals inserted, are filled with process data (manufacturer-specific default mapping). A manufacturer-specific default identifier allocation is carried out here for PDO5...11, while the transmission type and a uniform inhibit time is set for PDO 2...11. PDOs that do not have process data (and which are thus superfluous in the present configuration) are not activated.

● Pre-operational required

i This object can only be written in the pre-operational state!

The 32-bit value is used as follows:

MSB		LSB	
Transmission Type RxPDOs	Transmission Type TxPDOs	High byte inhibit time	Low byte inhibit time

As is usual in CANopen, the LSB is transferred first, followed by the MSB.

Example

Activate PDOs for bus node number 1, set inhibit time to 10ms (=100 x 100µs), set transmission type for TxPDOs to 255, and set transmission type for RxPDOs to 1. The following telegram should be sent:
 ID=0x601 DLC=8; data=23 00 55 00 64 00 FF 01

The node responds with the following telegram:
 ID=0x601 DLC=8; data=60 00 55 00 00 00 00 00

Identifiers used

The default identifier allocation for the additional PDOs leaves the pre-defined regions for guarding, SDOs etc. free, assumes a maximum of 64 nodes in the network with PDO6 as the next node, and proceeds according to the following scheme:

Object	Function Code	Resulting COB ID (hex)	Resulting COB ID (dec)
TxPDO5	1101	0x681 - 0x6BF	1665 - 1727
RxPDO5	1111	0x781 - 0x7BF	1921 - 1983
TxPDO6	00111	0x1C1 - 0x1FF	449 - 511
RxPDO6	01001	0x241 - 0x27F	577 - 639
TxDPO7	01011	0x2C1 - 0x2FF	705 - 767
RxPDO7	01101	0x341 - 0x37F	833 - 895
TxPDO8	01111	0x3C1 - 0x3FF	961 - 1023
RxPDO8	10001	0x441 - 0x47F	1089 - 1151
TxPDO9	10011	0x4C1 - 0x4FF	1217 - 1279
RxPDO9	10101	0x541 - 0x57F	1345 - 1407
TxDPO10	10111	0x5C1 - 0x5FF	1473 - 1535
RxPDO10	11001	0x641 - 0x67F	1601 - 1663
TxPDO11	11011	0x6C1 - 0x6FF	1729 - 1791
RxPDO11	11101	0x741 - 0x77F	1857 - 1919

NOTE

Index 0x5500

Ensure that index 0x5500 is not used if Bus Couplers with more than 5 PDOs are present in networks with node addresses > 64, otherwise identification overlaps can occur. In that case, the PDO identifiers must be set individually.

For the sake of clarity, the default identifiers defined according to CANopen are also listed here:

Object	Function Code	Resulting COB ID (hex)	Resulting COB ID (dec)
Emergency	0001	0x81 - 0xBF [0xFF]	129 - 191 [255]
TxPDO1	0011	0x181 - 0x1BF [0x1FF]	385 - 447 [511]
RxPDO1	0100	0x201 - 0x23F [0x27F]	513 - 575 [639]
TxPDO2	0101	0x281 - 0x2BF [0x2FF]	641 - 676 [767]
RxPDO2	0110	0x301 - 0x33F [0x37F]	769 - 831 [895]
TxDPO3	0111	0x381 - 0x3BF [0x3FF]	897 - 959 [1023]
RxPDO3	1000	0x401 - 0x43F [0x47F]	1025 - 1087 [1151]
TxPDO4	1001	0x481 - 0x4BF [0x4FF]	1153 - 1215 [1279]
RxPDO4	1010	0x501 - 0x53F [0x57F]	1281 - 1343 [1407]
SDO (Tx)	1011	0x581 - 0x5BF [0x5FF]	1409 - 1471 [1535]
SDO (Rx)	1100	0x601 - 0x63F [0x67F]	1537 - 1599 [1663]
Guarding / Heartbeat/ Bootup	1110	0x701 - 0x73F [0x77F]	1793 - 1855 [1919]

The identifiers that result from the DIP switch settings on the coupler are given, as are the identifier regions for the node addresses 64...127 (not settable in Bus Couplers BK5110, BK5120 and LC5100) in square brackets. Addresses 1...99 can be set for the Fieldbus Box modules and the BK515x Bus Couplers.

The appendix contains a tabular summary of all the identifiers.

Digital inputs

Index	Subindex	Name	Type	Attribute	Mapping	Default value	Meaning
0x6000	0	Number of elements	Unsigned8	ro	N	Depending on type and fittings	Number of available digital 8-bit input data blocks
	1	1st input block	Unsigned8	ro	Y	0x00	1 st input channel

	0xFE	254 th input block	Unsigned8	ro	Y	0x00	254 th input channel

Interrupt mask

Index	Subindex	Name	Type	Attribute	Mapping	Default value	Meaning
0x6126	0	Number of elements	Unsigned8	ro	N	Depending on type	The number of 32-bit interrupt masks = 2 x the number of TxPDOs
	1	IR-Mask0 Tx-PDO1	Unsigned32	rw	N	0xFFFFFFFF	IR-Mask Bytes 0...3 TxPDO1
	2	IR-Mask1 Tx-PDO1	Unsigned32	rw	N	0xFFFFFFFF	IR-Mask Bytes 4...7 TxPDO1
	3	IR-Mask0 Tx-PDO2	Unsigned32	rw	N	0xFFFFFFFF	IR-Mask Bytes 0...3 TxPDO2

	0x20	IR-Mask1 Tx-PDO16	Unsigned32	rw	N	0xFFFFFFFF	IR-Mask Bytes 4...7 TxPDO16

By default, every change in the value in an event-driven PDO causes a telegram to be sent. The interrupt mask makes it possible to determine which data changes are evaluated for this purpose. By clearing the appropriate ranges within the PDOs they are masked out for event-driving purposes (interrupt control). The interrupt mask does not just govern all the PDOs with digital inputs, but all the TxPDOs that are present. If the TxPDOs are shorter than 8 bytes, then the superfluous part of the IR mask is not evaluated.

The interrupt mask only has an effect on TxPDOs with transmission types 254 and 255. It is not stored in the device (not even through object 0x1010). Changes to the mask at runtime (when the status is operational) are possible, and are evaluated starting from the next change of input data.

The interrupt mask for TxPDOs with analog input data is not evaluated if either limit values (0x6424, 0x6425) or the delta function (0x6426) have been activated for the inputs.

This entry has been implemented in firmware C3 and above.

Example for data assignment

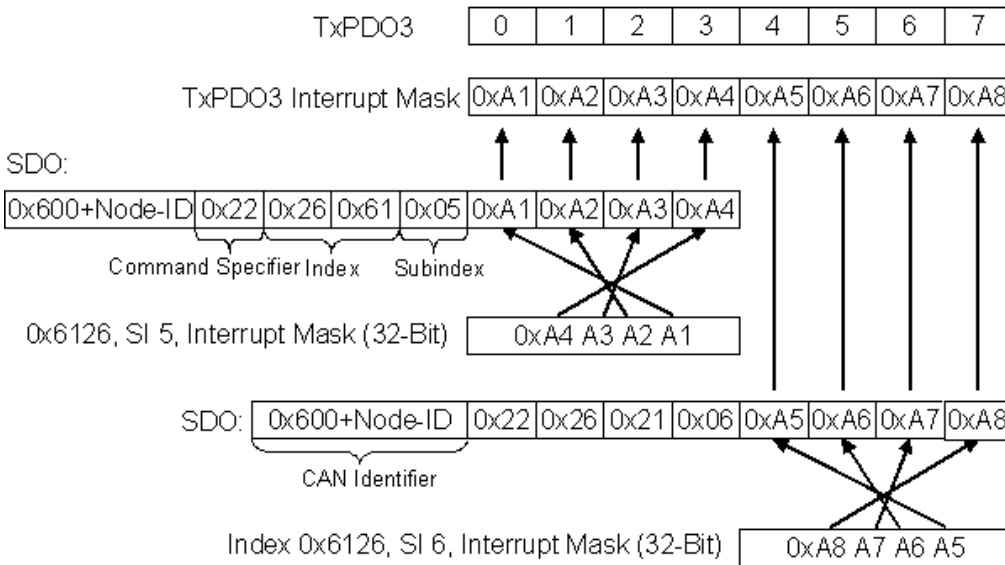

Fig. 140: Example for data assignment

Application example

The value contained in a fast counter input is only to be transmitted when bits in the status word (the latch input, for instance) have changed. This requires the 32 bit counter value to be masked out (zeroed) in the interrupt mask. The status is located in byte 0, while the counter value is, by default, contained in bytes 1..4 of the corresponding PDOs (TxPDO3 in this example, because < 65 digital and < 5 analog inputs are present).

This means that index 0x6126, subindex5 must receive the value 0x0000 00FF and that subindex6 must have 0xFFFF FF00 written into it.

The corresponding SDOs therefore appear as follows:

11 bit identifier	8 byte of user data							
0x600+ Node-ID	0x22	0x26	0x61	0x05	0xFF	0x00	0x00	0x00

11 bit identifier	8 byte of user data							
0x600+ Node-ID	0x22	0x26	0x61	0x06	0x00	0xFF	0xFF	0xFF

Digital outputs

Index	Subindex	Name	Type	Attribute	Mapping	Default value	Meaning
0x6200	0	Number of elements	Unsigned8	ro	N	Depending on type and fittings	Number of available digital 8-bit output data blocks
	1	1st input block	Unsigned8	rw	Y	0x00	1 st output channel

	0xFE	254 th input block	Unsigned8	rw	Y	0x00	254 th output channel

Analog inputs

Index	Subindex	Name	Type	Attribute	Mapping	Default value	Meaning
0x6401	0	Number of elements	Unsigned8	ro	N	Depending on type and fittings	Number of analog input channels available
	1	1st input	Unsigned16	ro	Y	0x0000	1 st input channel

	0xFE	254 th input	Unsigned16	ro	Y	0x0000	254 th input channel

The analog signals are displayed left aligned. The representation in the process image is therefore independent of the actual resolution. Detailed information on the data format can be found at the relevant signal type.

Analog outputs

Index	Subindex	Name	Type	Attribute	Mapping	Default value	Meaning
0x6411	0	Number of elements	Unsigned8	ro	N	Depending on type and fittings	Number of analog output channels available
	1	1st input block	Unsigned16	rw	Y	0x0000	1 st output channel

	0XFE	254 th input block	Unsigned16	rw	Y	0x0000	254 th output channel

The analog signals are displayed left aligned. The representation in the process image is therefore independent of the actual resolution. Detailed information on the data format can be found at the relevant signal type.

Event driven analog inputs

Index	Subindex	Name	Type	Attribute	Mapping	Default value	Meaning
0x6423	0	Global Interrupt Enable	Boolean	rw	N	FALSE (0)	Activates the event-driven transmission of PDOs with analog inputs.

Although, in accordance with CANopen, the analog inputs in TxPDO2..4 are by default set to transmission type 255 (event driven), the event (the alteration of an input value) is suppressed by the event control in object 0x6423, in order to prevent the bus from being swamped with analog signals. It is recommended that the flow of data associated with the analog PDOs is controlled either through synchronous communication or through using the event timer. In event-driven operation, the transmission behavior of the analog PDOs can be parameterized before activation by setting the inhibit time (object 0x1800ff, subindex 3) and/or limit value monitoring (objects 0x6424 + 0x6425) and/or delta function (object 0x6426).

Upper limit value analog inputs

Index	Subindex	Name	Type	Attribute	Mapping	Default value	Meaning
0x6424	0	Number of elements	Unsigned8	ro	N	Depending on type and fittings	Number of analog input channels available
	1	upper limit 1st input	Unsigned16	rw	Y	0x0000	Upper limit value for 1 st input channel

	0XFE	upper limit 254 th input	Unsigned16	rw	Y	0x0000	Upper limit value for 254 th input channel

Values different from 0 activate the upper limit value for this channel. A PDO is then transmitted if this limit value is exceeded. In addition, the event driven mode must be activated (object 0x6423). The data format corresponds to that of the analog inputs.

Lower limit value analog inputs

Index	Subindex	Name	Type	Attribute	Mapping	Default value	Meaning
0x6425	0	Number of elements	Unsigned8	ro	N	Depending on type and fittings	Number of analog input channels available
	1	lower limit 1st input	Unsigned16	rw	Y	0x0000	Lower limit value for 1 st input channel

	0XFE	lower limit 254 th input	Unsigned16	rw	Y	0x0000	Lower limit value for 254 th input channel

Values different from 0 activate the lower limit value for this channel. A PDO is then transmitted if the value falls below this limit value. In addition, the event driven mode must be activated (object 0x6423). The data format corresponds to that of the analog inputs.

Delta function for analog inputs

Index	Subindex	Name	Type	Attribute	Mapping	Default value	Meaning
0x6426	0	Number of elements	Unsigned8	ro	N	Depending on type and fittings	Number of analog input channels available
	1	delta value 1st input	Unsigned16	rw	Y	0x0000	Delta value for the 1 st input channel

	0XFE	delta value 254 th input	Unsigned16	rw	Y	0x0000	Delta value for the 254 th input channel

Values different from 0 activate the delta function for this channel. A PDO is then transmitted if the value has changed by more than the delta value since the last transmission. In addition, the event driven mode must be activated (object 0x6423). The data format corresponds to that of the analog inputs (delta value: can only have positive values).

6.3.4 Objects and data of BX5100/BC5150

Access to allocated flags

Index	Subindex	Name	Type	Attribute	Mapping	Default value	Meaning
0x2F00	0	Number of the subindex	Unsigned8	ro	N	128	Number of the subindex
	1	Flags	Unsigned32	rw	N	none	Flag %MB0..3
	2	Flags	Unsigned32	rw	N	none	Flag %MB4..7

	128	Flags	Unsigned32	rw	N	None	Flag %MB508..511

Index	Subindex	Name	Type	Attribute	Mapping	Default value	Meaning
0x2F01-0x2F07	0	Number of the subindex	Unsigned8	ro	N	128	Number of the subindex
	1	Flags	Unsigned32	rw	N	none	Flag %MBx..x+4
	2	Flags	Unsigned32	rw	N	none	Flag %MBy..y+4

	128	Flags	Unsigned32	rw	N	None	Flag %MBz...z+14

AMS NetId

Index	Subindex	Name	Type	Attribute	Mapping	Default value	Meaning
0x5FFE	0	NetId	String	rw	N	1.1.1.1.1	AMS Net Id

6.4 ADS-Communication

6.4.1 ADS services

See programming [▶ 99]

7 Error handling and diagnosis

7.1 Diagnostics

CANopen state

In many cases it is important to know whether the communication with the higher-level master is still OK. To this end, link the *NodeState* variable with your PLC program. A TwinCAT configuration is required for this purpose.

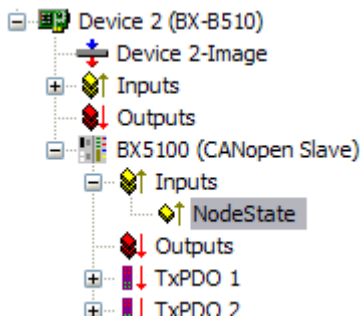

Fig. 141: CANopen diagnostic byte in the System Manager

Error number	Description	Remedy
0	No error	-
2	Guarding error	Check the connection
20	Too few PDOs (only TwinCAT configuration)	Check the configuration
22	Sync error	Check the connection
129	Node is pre-operational	Switch the node to operational
130	Node is stopped	Start the node

Example

If the CANopen is interrupted, e.g. if the cable is pulled or the PLC is switched off, the Bus Terminal Controller indicates this by reporting ??? in the node state.

Reading fieldbus state by ADS

You can read the fieldbus state via ADSREAD in the default configuration or in the TwinCAT configuration.

Parameter ADSREAD function block	Description
NetID	local – empty string
Port	1
IndexGroup	16#0006
IndexOffset	16#000C_AE00
LEN	1

State of the K-bus

An internal K-bus or Bus Terminal error is indicated in the K-bus state. A more precise fault description can be obtained via a function block (in preparation). To this end, link the *K-bus state* variable with your PLC program.

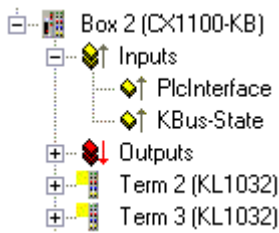

Fig. 142: State of the K-bus

Error bit	Description	Error type
0	No error	No error
Bit 0	K-bus error	Error
Bit 2	K-bus is re-triggered	Note

Reading K-bus state by ADS

You can read the fieldbus state via ADSREAD in the default configuration or in the TwinCAT configuration.

Parameter ADSREAD function block	Description
NetID	local – empty string
Port	1
IndexGroup	16#0006
IndexOffset	16#000C_9000
LEN	1

7.2 Diagnostic LEDs

A BX Controller has two groups of LEDs for status display:

- On the top right of the BX controller there are two green power LEDs. These are provided for diagnostics of the power supply of the BX Controller and of the power contacts.
- The DIAG LEDs are located above the navigation switch on the left. They indicate the state of the fieldbus, the PLC and the K-bus.

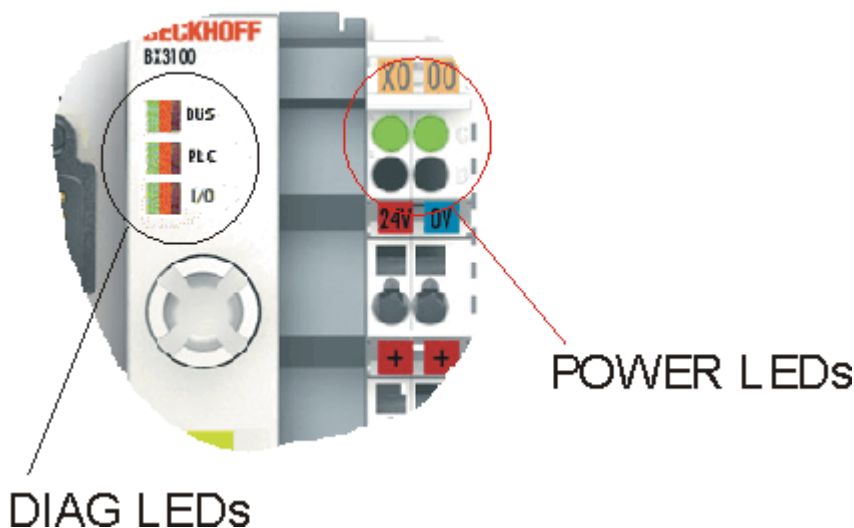

Fig. 143: Diagnostic LEDs for the fieldbus, the PLC, the K-bus and the power supply units

POWER LEDs for diagnostics of power supply

Power LEDs	Meaning
Left LED off	BX Controller has no power supply
Right LED off	Power contacts has no power supply

DIAG LEDs

The DIAG LEDs are sub-divided as follows:

- bus: fieldbus diagnostics
- PLC: PLC diagnostics
- I/O: K-bus diagnostics

The LEDs can be off, green, orange or red.



Fig. 144: Diagnostic LEDs for the fieldbus, the PLC and the K-bus

After switching on, the BX Controller immediately checks the connected configuration. The I/O LED goes out if the start-up was successful. A red I/O LED indicates a Bus Terminal error. The error type is shown in the display. This permits rapid rectification of the error.

LEDs for fieldbus diagnostics

LED Bus	Meaning
off	- no fieldbus connected - baud rate search enabled: BX Controller searches for the baud rate
red illuminated	Baud rate found and CAN controller at warning limit (e.g. plug connector pulled)
flashes red	Baud rate found and CAN error in bus off
orange illuminated	BX in pre-operational or stopped state (no error)
flashes orange	BX in pre-operational state with error Rapid flashing followed by 1 x slow flashing - guarding timeout 2 x slow flashing - sync timeout 3 x slow flashing - event timeout
green illuminated	Bus communication OK, BX Controller is exchanging data

LED for PLC diagnostics

LED PLC	Meaning
off	PLC in stop or no program available
flashes red	The set task time is sometimes exceeded (see also Chapter Deactivating the LED for cycle time exceeding).
red illuminated	The set task time is always exceeded.
orange illuminated	PLC runs without boot project (only lights up during the cycle), when the boot project is generated, the LED flashes orange
green illuminated	Boot project - PLC is running (only lights up during cycle)

LED for K-bus diagnostics

LED I/O	Meaning
off	No data are exchanged via the K-bus
red illuminated	error flashing - error type - display
orange illuminated	Register or KS2000 online access
green illuminated	K-bus OK and running

Error code for K-bus diagnostics

Error code	Error argument	Description	Remedy
0	-	EMC problems	<ul style="list-style-type: none"> • Check power supply for undervoltage or overvoltage peaks • Implement EMC measures • If a K-bus error is present, it can be localized by a restart of the coupler (by switching it off and then on again)
1	0	EEPROM checksum error	Enter factory settings with the KS2000 configuration software
	1	Code buffer overflow	Insert fewer Bus Terminals. The programmed configuration has too many entries in the table
	2	Unknown data type	Software update required for the BX Controller
2	-	reserved	-
3	0	K-bus command error	<ul style="list-style-type: none"> • No Bus Terminal inserted • One of the Bus Terminals is defective; halve the number of Bus Terminals attached and check whether the error is still present with the remaining Bus Terminals. Repeat until the defective Bus Terminal is located.
	n	Break behind Bus Terminal n	Check whether the KL9010 Bus End Terminal is connected.
4	0	K-bus data error, break behind the BX Controller	Check whether the n+1 Bus Terminal is correctly connected; replace if necessary.
	n	Break behind Bus Terminal n	Check whether the KL9010 Bus End Terminal is connected.
5	n	K-bus error in register communication with Bus Terminal n	Exchange the n th Bus Terminal
6	0	Error at initialization	Replace BX Controller
	1	Internal data error	Perform a hardware reset on the BX Controller (switch off and on again)
	2	DIP switch changed after a software reset	Perform a hardware reset on the BX Controller (switch off and on again)
7	0	Note: cycle time was exceeded	Warning: the set cycle time was exceeded. This indication (flashing LEDs) can only be cleared by booting the BX Controller again. Remedy: increase the cycle time
9	0	Checksum error in Flash program	Transmit program to the BX again
	1	Incorrect or faulty library implemented	Remove the faulty library
10	n	Bus Terminal n is not consistent with the configuration that existed when the boot project was created	Check the n th Bus Terminal. The boot project must be deleted if the insertion of an n th Bus Terminal is intentional.
14	n	n th Bus Terminal has the wrong format	Start the BX Controller again, and if the error occurs again then exchange the Bus Terminal.
15	n	Number of Bus Terminals is no longer correct	Start the BX Controller again. If the error occurs again, restore the manufacturers setting using the KS2000 configuration software
16	n	Length of the K-bus data is no longer correct	Start the BX Controller again. If the error occurs again, restore the manufacturers setting using the KS2000 configuration software

7.3 Diagnostics display

During start-up, the display shows the current firmware version for approx. three seconds.

If an error occurs during start-up, this will be indicated via a flash sequence of the associated LED.

Configuration errors are shown in the display via TC-Config and an error number. In this case, please use the System Manager to check your hardware configuration or contact support.

Display	Meaning
TC-Config 0xE02E	A complex Bus Terminal is assigned a bit address. Check the TwinCAT configuration.
TC-Config 0xF0nn	Bus Terminal no. nn does not correspond to the configuration. Compare the bus structure of Bus Terminal no. nn with the configuration.
TC-Config 0xC0nn	Bus Terminal no. nn does not correspond to the configuration. Compare the bus structure of Bus Terminal no. nn with the configuration.

Firmware errors are shown in the display via FW-Error and an error number. Please contact support.

Display	Meaning
FW-Error 0xnxxx	Please contact support

8 Appendix

8.1 Quick Start for Experienced Users

Target group

This brief introduction is intended for users who are already familiar with CAN. It clarifies the CAN messages that are required in order to work with Beckhoff CANopen input/output groups in the initial configuration (default settings).

It remains necessary to read and use the full documentation.

Hardware configuration

The DIP switches must be used to set a consistent data transfer rate and differing node addresses (node ID) on the Bus Couplers. The switch assignments are printed on the modules. It should be noted that CANopen uses address "0" to address all modules (broadcast), so that this cannot be set as the address of a particular module.

Starting the modules

CANopen allows the modules to be started with a single [network management \[► 134\]](#) telegram:

11 bit identifier	2-byte user data								
0x00	0x01	0x00							

The first data byte here contains the start command (Start_Remote_Node), while the second data byte contains the node address (here: 0, which addresses all nodes).

The inputs and outputs are enabled after the modules have been started. In the default setting the modules communicate in event-driven mode, so that changes at the digital inputs are immediately transmitted and outputs are immediately set in accordance with received telegrams containing output data.

CAN identifier

The CAN identifiers for the input and output data are derived from the node address (1-63):

Data type	Default CAN identifier
digital inputs 1...64	0x180 (=384 _{dec}) + node address
digital outputs 1...64	0x200 (=512 _{dec}) + node address
analog inputs 1...4	0x280 (=640 _{dec}) + node address
analog outputs 1...4	0x300 (=768 _{dec}) + node address
analog inputs 5...8*	0x380 (=896 _{dec}) + node address
analog outputs 5...8*	0x400 (=1024 _{dec}) + node address
analog inputs 9...12*	0x480 (=1152 _{dec}) + node address
analog outputs 9...12*	0x500 (=1280 _{dec}) + node address

* If more than 64 digital inputs or outputs are present, the range is offset accordingly (see section Default mapping).

Digital inputs

The CAN messages with digital input data are composed as follows:

11 bit identifier	1-8 bytes of user data (depending on the number of input terminals or extension modules)							
0x180(=384 _{dec}) + node ID	I0	I1	I2	I3	I4	I5	I6	I7

E0: Input bytes on input terminals (or Fieldbus Box modules), from left to right.

Digital outputs

The CAN messages with digital output data have the following structure:

11 bit identifier	1-8 bytes of user data (depending on the number of output terminals or extension modules)							
0x200(=512 _{dec}) + node ID	O0	O1	O2	O3	O4	O5	O6	O7

A0: Output bytes on output terminals (or Fieldbus Box modules), from left to right.

Analog inputs

CAN messages with analog input data look like this:

11 bit identifier	4-8 bytes of user data (depending on the number of analog inputs)							
0x280(640 _{dec}) + node ID	I0.0	I0.1	I1.0	I1.1	I2.0	I2.1	I3.0	I3.1

E x.0...E x.1: analog input x. A more detailed description of the data format can be found in the object directory under object [0x6401](#) [[▶ 163](#)].

The transmission behavior of analog inputs

To avoid "swamping" the bus with constantly changing analog input values, the analog CANopen input modules do not generate any data telegrams in the default state. The analog data can be read out by means of a remote access (Remote Transmit Request, a CAN message with no data and with the RTR bit set) to the analog input telegrams. Alternatively, of course, the module can be re-configured in such a way that an alteration of the input value does trigger the sending of a telegram. For this purpose a value > 0 is written into index [0x6423](#) [[▶ 163](#)] of the object directory. The corresponding SDO telegram looks like this:

11 bit identifier	8-byte user data							
0x600(=768 _{dec}) + node ID	0x22	0x23	0x64	0x00	0x01	0x00	0x00	0x00

It is recommended that event control (where every change in the LSB is considered an event, resulting in the corresponding telegram being transmitted) is not used for the transmission of input data, but that either cyclic, synchronous transmission or the event timer is used to send the data. If event control is indeed used, then the quantity of data should be reduced by setting a delta value (object directory index [0x6426](#) [[▶ 163](#)]), limit values ([0x6424](#) [[▶ 163](#)]+[0x6425](#) [[▶ 163](#)]) or an inhibit time (no new data transmission until the inhibit time has elapsed, 0x1801ff). Details of parameter communication are found in the section on [Service data: SDO](#) [[▶ 148](#)].

Analog outputs

CAN messages with analog output data look like this:

11 bit identifier	4-8 bytes of user data (depending on the number of analog outputs)							
0x300(=768 _{dec}) + node ID	O0.0	O0.1	O1.0	O1.1	O2.0	O2.1	O3.0	O3.1

A x.0...A x.1: analog output x. A more detailed description of the data format can be found in the object directory under object [0x6411](#) [[▶ 156](#)].

Default Identifier

The appendix contains a tabular summary of all the default identifiers. The CAN messages displayed on a CAN monitor can quickly and easily be identified with the help of that overview.

Stopping the modules

If necessary, the process data communication from the modules can be stopped with the following telegram:

11 bit identifier	2-byte user data								
0x00	0x80	0xYZ							

0xXX: node address; 0xYZ=0x00 addresses all modules

Guarding

The telegrams described above are themselves adequate for many applications. Since, however, the modules operate in event-driven mode by default (no cyclical data exchange), the failure of a module is not necessarily detected. A remedy for this is provided here through monitoring the modules by cyclically polling their status, a process known as node guarding.

For this purpose a status telegram is requested cyclically by means of remote transmit request (RTR):

11 bit identifier	No user data in the request telegram (RTR)
0x700(=1792 _{dec}) + node ID	(RTR bit set in the header)

The modules answer with a telegram that includes a status byte.

11 bit identifier	1-byte user data								
0x700(=1792 _{dec}) + node ID	0xYZ								

0xYZ: Status byte:

bits 6...0 contain the node status (0x7F=127: pre-operational, 0x05=operational; 0x04= stopped or prepared).

Bit 7 = toggle bit (inverts with every transmission).

So that the Bus Coupler can detect failure of the network master (watchdog function), the guard time [▶ 158] (object 0x100C) and the life time factor [▶ 158] (object 0x100D) must be set to have value different from 0. (response time in the event of a fault: Guard Time X Life Time Factor).

Heartbeat

As an alternative to guarding, the module can also be monitored by means of what is called the heartbeat. This involves a status telegram (the heartbeat) being issued cyclically by the node. Data request telegrams (remote frames) are not required.

In order to activate the heartbeat telegram, the producer heartbeat [▶ 160] time must be set. This is done with the following SDO [▶ 148] telegram:

11 bit identifier	8-byte user data							
0x600(=768 _{dec}) + node ID	0x22	0x17	0x10	0x00	0xcd	0xab	0x00	0x00

where 0xabcd is the desired heartbeat cycle time, expressed in milliseconds.

With the telegrams that have now been described you are in a position to start and stop the modules, read inputs, write outputs and to monitor the modules. Do not neglect to read the manual with attention. Only by doing so can you properly use the many features of the BECKHOFF CANopen Bus Coupler.

8.2 CAN Identifier List

The list provided here should assist in identifying and assigning CANopen messages. All the identifiers allocated by the CANopen default identifier allocation are listed, as well as the manufacturer-specific default identifiers issued by BECKHOFF via object [0x5500](#) [[174](#)] (only to be used in networks with node addresses less than 64).

The following values can be used as search aids and "entry points" in the extensive identifier table in the *chm edition of the documentation:

Decimal: [400](#) [[191](#)], [500](#) [[198](#)], [600](#) [[198](#)], [700](#) [[193](#)], [800](#) [[194](#)], [900](#) [[195](#)], [1000](#) [[200](#)], [1100](#) [[200](#)], [1200](#) [[196](#)], [1300](#) [[196](#)], [1400](#) [[201](#)], [1500](#) [[202](#)], [1600](#) [[202](#)], [1700](#) [[197](#)], [1800](#) [[205](#)], [1900](#) [[197](#)]

Hexadecimal: [0x181](#) [[191](#)], [0x1C1](#) [[198](#)], [0x201](#) [[192](#)], [0x301](#) [[194](#)], [0x401](#) [[195](#)], [0x501](#) [[196](#)], [0x601](#) [[204](#)], [0x701](#) [[205](#)]

The identifier distribution via object [0x5500](#) [[174](#)] follows this pattern:

Object	Resulting COB ID (dec)	Resulting COB ID (hex)
Emergency [191]	129 to 191 [255]	0x81 to 0xBF [0xFF]
TxPDO1 [191]	385 to 447 [511]	0x181 to 0x1BF [0x1FF]
RxPDO1 [192]	513 to 575 [639]	0x201 to 0x23F [0x27F]
TxPDO2 [193]	641 to 676 [767]	0x281 to 0x2BF [0x2FF]
RxPDO2 [194]	769 to 831 [895]	0x301 to 0x33F [0x37F]
TxPDO3 [195]	897 to 959 [1023]	0x381 to 0x3BF [0x3FF]
RxPDO3 [195]	1025 to 1087 [1151]	0x401 to 0x43F [0x47F]
TxPDO4 [196]	1153 to 1215 [1279]	0x481 to 0x4BF [0x4FF]
RxPDO4 [196]	1281 to 1343 [1407]	0x501 to 0x53F [0x57F]
TxPDO5 [197]	1665 to 1727	0x681 to 0x6BF
RxPDO5 [197]	1921 to 1983	0x781 to 0x7BF
TxPDO6 [198]	449 to 511	0x1C1 to 0x1FF
RxPDO6 [198]	577 to 639	0x241 to 0x27F
TxPDO7 [199]	705 to 767	0x2C1 to 0x2FF
RxPDO7 [199]	833 to 895	0x341 to 0x37F
TxPDO8 [200]	961 to 1023	0x3C1 to 0x3FF
RxPDO8 [200]	1089 to 1151	0x441 to 0x47F
TxPDO9 [201]	1217 to 1279	0x4C1 to 0x4FF
RxPDO9 [201]	1345 to 1407	0x541 to 0x57F
TxPDO10 [202]	1473 to 1535	0x5C1 to 0x5FF
RxPDO10 [202]	1601 to 1663	0x641 to 0x67F
TxPDO11 [203]	1729 to 1791	0x6C1 to 0x6FF
RxPDO11 [203]	1857 to 1919	0x741 to 0x77F
SDO (Tx) [204]	1409 to 1471 [1535]	0x581 to 0x5BF [0x5FF]
SDO (Rx) [204]	1537 to 1599 [1663]	0x601 to 0x63F [0x67F]
Guarding / Heartbeat/ Bootup [205]	1793 to 1855 [1919]	0x701 to 0x73F [0x77F]

Identifier List

Identifiers marked with * are given manufacturer-specific assignments on the Bus Couplers after writing index 0x5500

dec	hex	Telegram type	dec	hex	Telegram type	dec	hex	Telegram type
0	0x00	NMT	149	0x95	EMCY Nd.21	171	0xAB	EMCY Nd.43
128	0x80	SYNC	150	0x96	EMCY Nd.22	172	0xAC	EMCY Nd.44
129	0x81	EMCY Nd.1	151	0x97	EMCY Nd.23	173	0xAD	EMCY Nd.45
130	0x82	EMCY Nd.2	152	0x98	EMCY Nd.24	174	0xAE	EMCY Nd.46
131	0x83	EMCY Nd.3	153	0x99	EMCY Nd.25	175	0xAF	EMCY Nd.47
132	0x84	EMCY Nd.4	154	0x9A	EMCY Nd.26	176	0xB0	EMCY Nd.48
133	0x85	EMCY Nd.5	155	0x9B	EMCY Nd.27	177	0xB1	EMCY Nd.49
134	0x86	EMCY Nd.6	156	0x9C	EMCY Nd.28	178	0xB2	EMCY Nd.50
135	0x87	EMCY Nd.7	157	0x9D	EMCY Nd.29	179	0xB3	EMCY Nd.51
136	0x88	EMCY Nd.8	158	0x9E	EMCY Nd.30	180	0xB4	EMCY Nd.52
137	0x89	EMCY Nd.9	159	0x9F	EMCY Nd.31	181	0xB5	EMCY Nd.53
138	0x8A	EMCY Nd.10	160	0xA0	EMCY Nd.32	182	0xB6	EMCY Nd.54
139	0x8B	EMCY Nd.11	161	0xA1	EMCY Nd.33	183	0xB7	EMCY Nd.55
140	0x8C	EMCY Nd.12	162	0xA2	EMCY Nd.34	184	0xB8	EMCY Nd.56
141	0x8D	EMCY Nd.13	163	0xA3	EMCY Nd.35	185	0xB9	EMCY Nd.57
142	0x8E	EMCY Nd.14	164	0xA4	EMCY Nd.36	186	0xBA	EMCY Nd.58
143	0x8F	EMCY Nd.15	165	0xA5	EMCY Nd.37	187	0xBB	EMCY Nd.59
144	0x90	EMCY Nd.16	166	0xA6	EMCY Nd.38	188	0xBC	EMCY Nd.60
145	0x91	EMCY Nd.17	167	0xA7	EMCY Nd.39	189	0xBD	EMCY Nd.61
146	0x92	EMCY Nd.18	168	0xA8	EMCY Nd.40	190	0xBE	EMCY Nd.62
147	0x93	EMCY Nd.19	169	0xA9	EMCY Nd.41	191	0xBF	EMCY Nd.63
148	0x94	EMCY Nd.20	170	0xAA	EMCY Nd.42			

dec	hex	Telegram type	dec	hex	Telegram type	dec	hex	Telegram type
385	0x181	TxPDO1, DI, Nd.1	406	0x196	TxPDO1, DI, Nd.22	427	0x1AB	TxPDO1, DI, Nd.43
386	0x182	TxPDO1, DI, Nd.2	407	0x197	TxPDO1, DI, Nd.23	428	0x1AC	TxPDO1, DI, Nd.44
387	0x183	TxPDO1, DI, Nd.3	408	0x198	TxPDO1, DI, Nd.24	429	0x1AD	TxPDO1, DI, Nd.45
388	0x184	TxPDO1, DI, Nd.4	409	0x199	TxPDO1, DI, Nd.25	430	0x1AE	TxPDO1, DI, Nd.46
389	0x185	TxPDO1, DI, Nd.5	410	0x19A	TxPDO1, DI, Nd.26	431	0x1AF	TxPDO1, DI, Nd.47
390	0x186	TxPDO1, DI, Nd.6	411	0x19B	TxPDO1, DI, Nd.27	432	0x1B0	TxPDO1, DI, Nd.48
391	0x187	TxPDO1, DI, Nd.7	412	0x19C	TxPDO1, DI, Nd.28	433	0x1B1	TxPDO1, DI, Nd.49
392	0x188	TxPDO1, DI, Nd.8	413	0x19D	TxPDO1, DI, Nd.29	434	0x1B2	TxPDO1, DI, Nd.50
393	0x189	TxPDO1, DI, Nd.9	414	0x19E	TxPDO1, DI, Nd.30	435	0x1B3	TxPDO1, DI, Nd.51
394	0x18A	TxPDO1, DI, Nd.10	415	0x19F	TxPDO1, DI, Nd.31	436	0x1B4	TxPDO1, DI, Nd.52
395	0x18B	TxPDO1, DI, Nd.11	416	0x1A0	TxPDO1, DI, Nd.32	437	0x1B5	TxPDO1, DI, Nd.53
396	0x18C	TxPDO1, DI, Nd.12	417	0x1A1	TxPDO1, DI, Nd.33	438	0x1B6	TxPDO1, DI, Nd.54
397	0x18D	TxPDO1, DI, Nd.13	418	0x1A2	TxPDO1, DI, Nd.34	439	0x1B7	TxPDO1, DI, Nd.55
398	0x18E	TxPDO1, DI, Nd.14	419	0x1A3	TxPDO1, DI, Nd.35	440	0x1B8	TxPDO1, DI, Nd.56
399	0x18F	TxPDO1, DI, Nd.15	420	0x1A4	TxPDO1, DI, Nd.36	441	0x1B9	TxPDO1, DI, Nd.57
400	0x190	TxPDO1, DI, Nd.16	421	0x1A5	TxPDO1, DI, Nd.37	442	0x1BA	TxPDO1, DI, Nd.58
401	0x191	TxPDO1, DI, Nd.17	422	0x1A6	TxPDO1, DI, Nd.38	443	0x1BB	TxPDO1, DI, Nd.59
402	0x192	TxPDO1, DI, Nd.18	423	0x1A7	TxPDO1, DI, Nd.39	444	0x1BC	TxPDO1, DI, Nd.60
403	0x193	TxPDO1, DI, Nd.19	424	0x1A8	TxPDO1, DI, Nd.40	445	0x1BD	TxPDO1, DI, Nd.61
404	0x194	TxPDO1, DI, Nd.20	425	0x1A9	TxPDO1, DI, Nd.41	446	0x1BE	TxPDO1, DI, Nd.62
405	0x195	TxPDO1, DI, Nd.21	426	0x1AA	TxPDO1, DI, Nd.42	447	0x1BF	TxPDO1, DI, Nd.63

dec	hex	Telegram type	dec	hex	Telegram type	dec	hex	Telegram type
513	0x201	RxPDO1, DO, Nd.1	534	0x216	RxPDO1, DO, Nd.22	555	0x22B	RxPDO1, DO, Nd.43
514	0x202	RxPDO1, DO, Nd.2	535	0x217	RxPDO1, DO, Nd.23	556	0x22C	RxPDO1, DO, Nd.44
515	0x203	RxPDO1, DO, Nd.3	536	0x218	RxPDO1, DO, Nd.24	557	0x22D	RxPDO1, DO, Nd.45
516	0x204	RxPDO1, DO, Nd.4	537	0x219	RxPDO1, DO, Nd.25	558	0x22E	RxPDO1, DO, Nd.46
517	0x205	RxPDO1, DO, Nd.5	538	0x21A	RxPDO1, DO, Nd.26	559	0x22F	RxPDO1, DO, Nd.47
518	0x206	RxPDO1, DO, Nd.6	539	0x21B	RxPDO1, DO, Nd.27	560	0x230	RxPDO1, DO, Nd.48
519	0x207	RxPDO1, DO, Nd.7	540	0x21C	RxPDO1, DO, Nd.28	561	0x231	RxPDO1, DO, Nd.49
520	0x208	RxPDO1, DO, Nd.8	541	0x21D	RxPDO1, DO, Nd.29	562	0x232	RxPDO1, DO, Nd.50
521	0x209	RxPDO1, DO, Nd.9	542	0x21E	RxPDO1, DO, Nd.30	563	0x233	RxPDO1, DO, Nd.51
522	0x20A	RxPDO1, DO, Nd.10	543	0x21F	RxPDO1, DO, Nd.31	564	0x234	RxPDO1, DO, Nd.52
523	0x20B	RxPDO1, DO, Nd.11	544	0x220	RxPDO1, DO, Nd.32	565	0x235	RxPDO1, DO, Nd.53
524	0x20C	RxPDO1, DO, Nd.12	545	0x221	RxPDO1, DO, Nd.33	566	0x236	RxPDO1, DO, Nd.54
525	0x20D	RxPDO1, DO, Nd.13	546	0x222	RxPDO1, DO, Nd.34	567	0x237	RxPDO1, DO, Nd.55
526	0x20E	RxPDO1, DO, Nd.14	547	0x223	RxPDO1, DO, Nd.35	568	0x238	RxPDO1, DO, Nd.56
527	0x20F	RxPDO1, DO, Nd.15	548	0x224	RxPDO1, DO, Nd.36	569	0x239	RxPDO1, DO, Nd.57
528	0x210	RxPDO1, DO, Nd.16	549	0x225	RxPDO1, DO, Nd.37	570	0x23A	RxPDO1, DO, Nd.58
529	0x211	RxPDO1, DO, Nd.17	550	0x226	RxPDO1, DO, Nd.38	571	0x23B	RxPDO1, DO, Nd.59
530	0x212	RxPDO1, DO, Nd.18	551	0x227	RxPDO1, DO, Nd.39	572	0x23C	RxPDO1, DO, Nd.60
531	0x213	RxPDO1, DO, Nd.19	552	0x228	RxPDO1, DO, Nd.40	573	0x23D	RxPDO1, DO, Nd.61
532	0x214	RxPDO1, DO, Nd.20	553	0x229	RxPDO1, DO, Nd.41	574	0x23E	RxPDO1, DO, Nd.62
533	0x215	RxPDO1, DO, Nd.21	554	0x22A	RxPDO1, DO, Nd.42	575	0x23F	RxPDO1, DO, Nd.63

dec	hex	Telegram type	dec	hex	Telegram type	dec	hex	Telegram type
641	0x281	TxPDO2, AI, Nd.1	662	0x296	TxPDO2, AI, Nd.22	683	0x2AB	TxPDO2, AI, Nd.43
642	0x282	TxPDO2, AI, Nd.2	663	0x297	TxPDO2, AI, Nd.23	684	0x2AC	TxPDO2, AI, Nd.44
643	0x283	TxPDO2, AI, Nd.3	664	0x298	TxPDO2, AI, Nd.24	685	0x2AD	TxPDO2, AI, Nd.45
644	0x284	TxPDO2, AI, Nd.4	665	0x299	TxPDO2, AI, Nd.25	686	0x2AE	TxPDO2, AI, Nd.46
645	0x285	TxPDO2, AI, Nd.5	666	0x29A	TxPDO2, AI, Nd.26	687	0x2AF	TxPDO2, AI, Nd.47
646	0x286	TxPDO2, AI, Nd.6	667	0x29B	TxPDO2, AI, Nd.27	688	0x2B0	TxPDO2, AI, Nd.48
647	0x287	TxPDO2, AI, Nd.7	668	0x29C	TxPDO2, AI, Nd.28	689	0x2B1	TxPDO2, AI, Nd.49
648	0x288	TxPDO2, AI, Nd.8	669	0x29D	TxPDO2, AI, Nd.29	690	0x2B2	TxPDO2, AI, Nd.50
649	0x289	TxPDO2, AI, Nd.9	670	0x29E	TxPDO2, AI, Nd.30	691	0x2B3	TxPDO2, AI, Nd.51
650	0x28A	TxPDO2, AI, Nd.10	671	0x29F	TxPDO2, AI, Nd.31	692	0x2B4	TxPDO2, AI, Nd.52
651	0x28B	TxPDO2, AI, Nd.11	672	0x2A0	TxPDO2, AI, Nd.32	693	0x2B5	TxPDO2, AI, Nd.53
652	0x28C	TxPDO2, AI, Nd.12	673	0x2A1	TxPDO2, AI, Nd.33	694	0x2B6	TxPDO2, AI, Nd.54
653	0x28D	TxPDO2, AI, Nd.13	674	0x2A2	TxPDO2, AI, Nd.34	695	0x2B7	TxPDO2, AI, Nd.55
654	0x28E	TxPDO2, AI, Nd.14	675	0x2A3	TxPDO2, AI, Nd.35	696	0x2B8	TxPDO2, AI, Nd.56
655	0x28F	TxPDO2, AI, Nd.15	676	0x2A4	TxPDO2, AI, Nd.36	697	0x2B9	TxPDO2, AI, Nd.57
656	0x290	TxPDO2, AI, Nd.16	677	0x2A5	TxPDO2, AI, Nd.37	698	0x2BA	TxPDO2, AI, Nd.58
657	0x291	TxPDO2, AI, Nd.17	678	0x2A6	TxPDO2, AI, Nd.38	699	0x2BB	TxPDO2, AI, Nd.59
658	0x292	TxPDO2, AI, Nd.18	679	0x2A7	TxPDO2, AI, Nd.39	700	0x2BC	TxPDO2, AI, Nd.60
659	0x293	TxPDO2, AI, Nd.19	680	0x2A8	TxPDO2, AI, Nd.40	701	0x2BD	TxPDO2, AI, Nd.61
660	0x294	TxPDO2, AI, Nd.20	681	0x2A9	TxPDO2, AI, Nd.41	702	0x2BE	TxPDO2, AI, Nd.62
661	0x295	TxPDO2, AI, Nd.21	682	0x2AA	TxPDO2, AI, Nd.42	703	0x2BF	TxPDO2, AI, Nd.63

dec	hex	Telegram type	dec	hex	Telegram type	dec	hex	Telegram type
769	0x301	RxPDO2, AO, Nd.1	790	0x316	RxPDO2, AO, Nd.22	811	0x32B	RxPDO2, AO, Nd.43
770	0x302	RxPDO2, AO, Nd.2	791	0x317	RxPDO2, AO, Nd.23	812	0x32C	RxPDO2, AO, Nd.44
771	0x303	RxPDO2, AO, Nd.3	792	0x318	RxPDO2, AO, Nd.24	813	0x32D	RxPDO2, AO, Nd.45
772	0x304	RxPDO2, AO, Nd.4	793	0x319	RxPDO2, AO, Nd.25	814	0x32E	RxPDO2, AO, Nd.46
773	0x305	RxPDO2, AO, Nd.5	794	0x31A	RxPDO2, AO, Nd.26	815	0x32F	RxPDO2, AO, Nd.47
774	0x306	RxPDO2, AO, Nd.6	795	0x31B	RxPDO2, AO, Nd.27	816	0x330	RxPDO2, AO, Nd.48
775	0x307	RxPDO2, AO, Nd.7	796	0x31C	RxPDO2, AO, Nd.28	817	0x331	RxPDO2, AO, Nd.49
776	0x308	RxPDO2, AO, Nd.8	797	0x31D	RxPDO2, AO, Nd.29	818	0x332	RxPDO2, AO, Nd.50
777	0x309	RxPDO2, AO, Nd.9	798	0x31E	RxPDO2, AO, Nd.30	819	0x333	RxPDO2, AO, Nd.51
778	0x30A	RxPDO2, AO, Nd.10	799	0x31F	RxPDO2, AO, Nd.31	820	0x334	RxPDO2, AO, Nd.52
779	0x30B	RxPDO2, AO, Nd.11	800	0x320	RxPDO2, AO, Nd.32	821	0x335	RxPDO2, AO, Nd.53
780	0x30C	RxPDO2, AO, Nd.12	801	0x321	RxPDO2, AO, Nd.33	822	0x336	RxPDO2, AO, Nd.54
781	0x30D	RxPDO2, AO, Nd.13	802	0x322	RxPDO2, AO, Nd.34	823	0x337	RxPDO2, AO, Nd.55
782	0x30E	RxPDO2, AO, Nd.14	803	0x323	RxPDO2, AO, Nd.35	824	0x338	RxPDO2, AO, Nd.56
783	0x30F	RxPDO2, AO, Nd.15	804	0x324	RxPDO2, AO, Nd.36	825	0x339	RxPDO2, AO, Nd.57
784	0x310	RxPDO2, AO, Nd.16	805	0x325	RxPDO2, AO, Nd.37	826	0x33A	RxPDO2, AO, Nd.58
785	0x311	RxPDO2, AO, Nd.17	806	0x326	RxPDO2, AO, Nd.38	827	0x33B	RxPDO2, AO, Nd.59
786	0x312	RxPDO2, AO, Nd.18	807	0x327	RxPDO2, AO, Nd.39	828	0x33C	RxPDO2, AO, Nd.60
787	0x313	RxPDO2, AO, Nd.19	808	0x328	RxPDO2, AO, Nd.40	829	0x33D	RxPDO2, AO, Nd.61
788	0x314	RxPDO2, AO, Nd.20	809	0x329	RxPDO2, AO, Nd.41	830	0x33E	RxPDO2, AO, Nd.62
789	0x315	RxPDO2, AO, Nd.21	810	0x32A	RxPDO2, AO, Nd.42	831	0x33F	RxPDO2, AO, Nd.63

dec	hex	Telegram type	dec	hex	Telegram type	dec	hex	Telegram type
897	0x381	TxPDO3*, Nd.1	918	0x396	TxPDO3*, Nd.22	939	0x3AB	TxPDO3*, Nd.43
898	0x382	TxPDO3*, Nd.2	919	0x397	TxPDO3*, Nd.23	940	0x3AC	TxPDO3*, Nd.44
899	0x383	TxPDO3*, Nd.3	920	0x398	TxPDO3*, Nd.24	941	0x3AD	TxPDO3*, Nd.45
900	0x384	TxPDO3*, Nd.4	921	0x399	TxPDO3*, Nd.25	942	0x3AE	TxPDO3*, Nd.46
901	0x385	TxPDO3*, Nd.5	922	0x39A	TxPDO3*, Nd.26	943	0x3AF	TxPDO3*, Nd.47
902	0x386	TxPDO3*, Nd.6	923	0x39B	TxPDO3*, Nd.27	944	0x3B0	TxPDO3*, Nd.48
903	0x387	TxPDO3*, Nd.7	924	0x39C	TxPDO3*, Nd.28	945	0x3B1	TxPDO3*, Nd.49
904	0x388	TxPDO3*, Nd.8	925	0x39D	TxPDO3*, Nd.29	946	0x3B2	TxPDO3*, Nd.50
905	0x389	TxPDO3*, Nd.9	926	0x39E	TxPDO3*, Nd.30	947	0x3B3	TxPDO3*, Nd.51
906	0x38A	TxPDO3*, Nd.10	927	0x39F	TxPDO3*, Nd.31	948	0x3B4	TxPDO3*, Nd.52
907	0x38B	TxPDO3*, Nd.11	928	0x3A0	TxPDO3*, Nd.32	949	0x3B5	TxPDO3*, Nd.53
908	0x38C	TxPDO3*, Nd.12	929	0x3A1	TxPDO3*, Nd.33	950	0x3B6	TxPDO3*, Nd.54
909	0x38D	TxPDO3*, Nd.13	930	0x3A2	TxPDO3*, Nd.34	951	0x3B7	TxPDO3*, Nd.55
910	0x38E	TxPDO3*, Nd.14	931	0x3A3	TxPDO3*, Nd.35	952	0x3B8	TxPDO3*, Nd.56
911	0x38F	TxPDO3*, Nd.15	932	0x3A4	TxPDO3*, Nd.36	953	0x3B9	TxPDO3*, Nd.57
912	0x390	TxPDO3*, Nd.16	933	0x3A5	TxPDO3*, Nd.37	954	0x3BA	TxPDO3*, Nd.58
913	0x391	TxPDO3*, Nd.17	934	0x3A6	TxPDO3*, Nd.38	955	0x3BB	TxPDO3*, Nd.59
914	0x392	TxPDO3*, Nd.18	935	0x3A7	TxPDO3*, Nd.39	956	0x3BC	TxPDO3*, Nd.60
915	0x393	TxPDO3*, Nd.19	936	0x3A8	TxPDO3*, Nd.40	957	0x3BD	TxPDO3*, Nd.61
916	0x394	TxPDO3*, Nd.20	937	0x3A9	TxPDO3*, Nd.41	958	0x3BE	TxPDO3*, Nd.62
917	0x395	TxPDO3*, Nd.21	938	0x3AA	TxPDO3*, Nd.42	959	0x3BF	TxPDO3*, Nd.63

dec	hex	Telegram type	dec	hex	Telegram type	dec	hex	Telegram type
1025	0x401	RxPDO3*, Nd.1	1046	0x416	RxPDO3*, Nd.22	1067	0x42B	RxPDO3*, Nd.43
1026	0x402	RxPDO3*, Nd.2	1047	0x417	RxPDO3*, Nd.23	1068	0x42C	RxPDO3*, Nd.44
1027	0x403	RxPDO3*, Nd.3	1048	0x418	RxPDO3*, Nd.24	1069	0x42D	RxPDO3*, Nd.45
1028	0x404	RxPDO3*, Nd.4	1049	0x419	RxPDO3*, Nd.25	1070	0x42E	RxPDO3*, Nd.46
1029	0x405	RxPDO3*, Nd.5	1050	0x41A	RxPDO3*, Nd.26	1071	0x42F	RxPDO3*, Nd.47
1030	0x406	RxPDO3*, Nd.6	1051	0x41B	RxPDO3*, Nd.27	1072	0x430	RxPDO3*, Nd.48
1031	0x407	RxPDO3*, Nd.7	1052	0x41C	RxPDO3*, Nd.28	1073	0x431	RxPDO3*, Nd.49
1032	0x408	RxPDO3*, Nd.8	1053	0x41D	RxPDO3*, Nd.29	1074	0x432	RxPDO3*, Nd.50
1033	0x409	RxPDO3*, Nd.9	1054	0x41E	RxPDO3*, Nd.30	1075	0x433	RxPDO3*, Nd.51
1034	0x40A	RxPDO3*, Nd.10	1055	0x41F	RxPDO3*, Nd.31	1076	0x434	RxPDO3*, Nd.52
1035	0x40B	RxPDO3*, Nd.11	1056	0x420	RxPDO3*, Nd.32	1077	0x435	RxPDO3*, Nd.53
1036	0x40C	RxPDO3*, Nd.12	1057	0x421	RxPDO3*, Nd.33	1078	0x436	RxPDO3*, Nd.54
1037	0x40D	RxPDO3*, Nd.13	1058	0x422	RxPDO3*, Nd.34	1079	0x437	RxPDO3*, Nd.55
1038	0x40E	RxPDO3*, Nd.14	1059	0x423	RxPDO3*, Nd.35	1080	0x438	RxPDO3*, Nd.56
1039	0x40F	RxPDO3*, Nd.15	1060	0x424	RxPDO3*, Nd.36	1081	0x439	RxPDO3*, Nd.57
1040	0x410	RxPDO3*, Nd.16	1061	0x425	RxPDO3*, Nd.37	1082	0x43A	RxPDO3*, Nd.58
1041	0x411	RxPDO3*, Nd.17	1062	0x426	RxPDO3*, Nd.38	1083	0x43B	RxPDO3*, Nd.59
1042	0x412	RxPDO3*, Nd.18	1063	0x427	RxPDO3*, Nd.39	1084	0x43C	RxPDO3*, Nd.60
1043	0x413	RxPDO3*, Nd.19	1064	0x428	RxPDO3*, Nd.40	1085	0x43D	RxPDO3*, Nd.61
1044	0x414	RxPDO3*, Nd.20	1065	0x429	RxPDO3*, Nd.41	1086	0x43E	RxPDO3*, Nd.62
1045	0x415	RxPDO3*, Nd.21	1066	0x42A	RxPDO3*, Nd.42	1087	0x43F	RxPDO3*, Nd.63

dec	hex	Telegram type	dec	hex	Telegram type	dec	hex	Telegram type
1153	0x481	TxPDO4*, Nd.1	1174	0x496	TxPDO4*, Nd.22	1195	0x4AB	TxPDO4*, Nd.43
1154	0x482	TxPDO4*, Nd.2	1175	0x497	TxPDO4*, Nd.23	1196	0x4AC	TxPDO4*, Nd.44
1155	0x483	TxPDO4*, Nd.3	1176	0x498	TxPDO4*, Nd.24	1197	0x4AD	TxPDO4*, Nd.45
1156	0x484	TxPDO4*, Nd.4	1177	0x499	TxPDO4*, Nd.25	1198	0x4AE	TxPDO4*, Nd.46
1157	0x485	TxPDO4*, Nd.5	1178	0x49A	TxPDO4*, Nd.26	1199	0x4AF	TxPDO4*, Nd.47
1158	0x486	TxPDO4*, Nd.6	1179	0x49B	TxPDO4*, Nd.27	1200	0x4B0	TxPDO4*, Nd.48
1159	0x487	TxPDO4*, Nd.7	1180	0x49C	TxPDO4*, Nd.28	1201	0x4B1	TxPDO4*, Nd.49
1160	0x488	TxPDO4*, Nd.8	1181	0x49D	TxPDO4*, Nd.29	1202	0x4B2	TxPDO4*, Nd.50
1161	0x489	TxPDO4*, Nd.9	1182	0x49E	TxPDO4*, Nd.30	1203	0x4B3	TxPDO4*, Nd.51
1162	0x48A	TxPDO4*, Nd.10	1183	0x49F	TxPDO4*, Nd.31	1204	0x4B4	TxPDO4*, Nd.52
1163	0x48B	TxPDO4*, Nd.11	1184	0x4A0	TxPDO4*, Nd.32	1205	0x4B5	TxPDO4*, Nd.53
1164	0x48C	TxPDO4*, Nd.12	1185	0x4A1	TxPDO4*, Nd.33	1206	0x4B6	TxPDO4*, Nd.54
1165	0x48D	TxPDO4*, Nd.13	1186	0x4A2	TxPDO4*, Nd.34	1207	0x4B7	TxPDO4*, Nd.55
1166	0x48E	TxPDO4*, Nd.14	1187	0x4A3	TxPDO4*, Nd.35	1208	0x4B8	TxPDO4*, Nd.56
1167	0x48F	TxPDO4*, Nd.15	1188	0x4A4	TxPDO4*, Nd.36	1209	0x4B9	TxPDO4*, Nd.57
1168	0x490	TxPDO4*, Nd.16	1189	0x4A5	TxPDO4*, Nd.37	1210	0x4BA	TxPDO4*, Nd.58
1169	0x491	TxPDO4*, Nd.17	1190	0x4A6	TxPDO4*, Nd.48	1211	0x4BB	TxPDO4*, Nd.59
1170	0x492	TxPDO4*, Nd.18	1191	0x4A7	TxPDO4*, Nd.49	1212	0x4BC	TxPDO4*, Nd.60
1171	0x493	TxPDO4*, Nd.19	1192	0x4A8	TxPDO4*, Nd.40	1213	0x4BD	TxPDO4*, Nd.61
1172	0x494	TxPDO4*, Nd.20	1193	0x4A9	TxPDO4*, Nd.41	1214	0x4BE	TxPDO4*, Nd.62
1173	0x495	TxPDO4*, Nd.21	1194	0x4AA	TxPDO4*, Nd.42	1215	0x4BF	TxPDO4*, Nd.63

dec	hex	Telegram type	dec	hex	Telegram type	dec	hex	Telegram type
1281	0x501	RxPDO4*, Nd.1	1302	0x516	RxPDO4*, Nd.22	1323	0x52B	RxPDO4*, Nd.43
1282	0x502	RxPDO4*, Nd.2	1303	0x517	RxPDO4*, Nd.23	1324	0x52C	RxPDO4*, Nd.44
1283	0x503	RxPDO4*, Nd.3	1304	0x518	RxPDO4*, Nd.24	1325	0x52D	RxPDO4*, Nd.45
1284	0x504	RxPDO4*, Nd.4	1305	0x519	RxPDO4*, Nd.25	1326	0x52E	RxPDO4*, Nd.46
1285	0x505	RxPDO4*, Nd.5	1306	0x51A	RxPDO4*, Nd.26	1327	0x52F	RxPDO4*, Nd.47
1286	0x506	RxPDO4*, Nd.6	1307	0x51B	RxPDO4*, Nd.27	1328	0x530	RxPDO4*, Nd.48
1287	0x507	RxPDO4*, Nd.7	1308	0x51C	RxPDO4*, Nd.28	1329	0x531	RxPDO4*, Nd.49
1288	0x508	RxPDO4*, Nd.8	1309	0x51D	RxPDO4*, Nd.29	1330	0x532	RxPDO4*, Nd.50
1289	0x509	RxPDO4*, Nd.9	1310	0x51E	RxPDO4*, Nd.30	1331	0x533	RxPDO4*, Nd.51
1290	0x50A	RxPDO4*, Nd.10	1311	0x51F	RxPDO4*, Nd.31	1332	0x534	RxPDO4*, Nd.52
1291	0x50B	RxPDO4*, Nd.11	1312	0x520	RxPDO4*, Nd.32	1333	0x535	RxPDO4*, Nd.53
1292	0x50C	RxPDO4*, Nd.12	1313	0x521	RxPDO4*, Nd.33	1334	0x536	RxPDO4*, Nd.54
1293	0x50D	RxPDO4*, Nd.13	1314	0x522	RxPDO4*, Nd.34	1335	0x537	RxPDO4*, Nd.55
1294	0x50E	RxPDO4*, Nd.14	1315	0x523	RxPDO4*, Nd.35	1336	0x538	RxPDO4*, Nd.56
1295	0x50F	RxPDO4*, Nd.15	1316	0x524	RxPDO4*, Nd.36	1337	0x539	RxPDO4*, Nd.57
1296	0x510	RxPDO4*, Nd.16	1317	0x525	RxPDO4*, Nd.37	1338	0x53A	RxPDO4*, Nd.58
1297	0x511	RxPDO4*, Nd.17	1318	0x526	RxPDO4*, Nd.38	1339	0x53B	RxPDO4*, Nd.59
1298	0x512	RxPDO4*, Nd.18	1319	0x527	RxPDO4*, Nd.39	1340	0x53C	RxPDO4*, Nd.60
1299	0x513	RxPDO4*, Nd.19	1320	0x528	RxPDO4*, Nd.40	1341	0x53D	RxPDO4*, Nd.61
1300	0x514	RxPDO4*, Nd.20	1321	0x529	RxPDO4*, Nd.41	1342	0x53E	RxPDO4*, Nd.62
1301	0x515	RxPDO4*, Nd.21	1322	0x52A	RxPDO4*, Nd.42	1343	0x53F	RxPDO4*, Nd.63

dec	hex	Telegram type	dec	hex	Telegram type	dec	hex	Telegram type
1665	0x681	TxPDO5*, Nd.1	1686	0x696	TxPDO5*, Nd.22	1707	0x6AB	TxPDO5*, Nd.43
1666	0x682	TxPDO5*, Nd.2	1687	0x697	TxPDO5*, Nd.23	1708	0x6AC	TxPDO5*, Nd.44
1667	0x683	TxPDO5*, Nd.3	1688	0x698	TxPDO5*, Nd.24	1709	0x6AD	TxPDO5*, Nd.45
1668	0x684	TxPDO5*, Nd.4	1689	0x699	TxPDO5*, Nd.25	1710	0x6AE	TxPDO5*, Nd.46
1669	0x685	TxPDO5*, Nd.5	1690	0x69A	TxPDO5*, Nd.26	1711	0x6AF	TxPDO5*, Nd.47
1670	0x686	TxPDO5*, Nd.6	1691	0x69B	TxPDO5*, Nd.27	1712	0x6B0	TxPDO5*, Nd.48
1671	0x687	TxPDO5*, Nd.7	1692	0x69C	TxPDO5*, Nd.28	1713	0x6B1	TxPDO5*, Nd.49
1672	0x688	TxPDO5*, Nd.8	1693	0x69D	TxPDO5*, Nd.29	1714	0x6B2	TxPDO5*, Nd.50
1673	0x689	TxPDO5*, Nd.9	1694	0x69E	TxPDO5*, Nd.30	1715	0x6B3	TxPDO5*, Nd.51
1674	0x68A	TxPDO5*, Nd.10	1695	0x69F	TxPDO5*, Nd.31	1716	0x6B4	TxPDO5*, Nd.52
1675	0x68B	TxPDO5*, Nd.11	1696	0x6A0	TxPDO5*, Nd.32	1717	0x6B5	TxPDO5*, Nd.53
1676	0x68C	TxPDO5*, Nd.12	1697	0x6A1	TxPDO5*, Nd.33	1718	0x6B6	TxPDO5*, Nd.54
1677	0x68D	TxPDO5*, Nd.13	1698	0x6A2	TxPDO5*, Nd.34	1719	0x6B7	TxPDO5*, Nd.55
1678	0x68E	TxPDO5*, Nd.14	1699	0x6A3	TxPDO5*, Nd.35	1720	0x6B8	TxPDO5*, Nd.56
1679	0x68F	TxPDO5*, Nd.15	1700	0x6A4	TxPDO5*, Nd.36	1721	0x6B9	TxPDO5*, Nd.57
1680	0x690	TxPDO5*, Nd.16	1701	0x6A5	TxPDO5*, Nd.37	1722	0x6BA	TxPDO5*, Nd.58
1681	0x691	TxPDO5*, Nd.17	1702	0x6A6	TxPDO5*, Nd.38	1723	0x6BB	TxPDO5*, Nd.59
1682	0x692	TxPDO5*, Nd.18	1703	0x6A7	TxPDO5*, Nd.39	1724	0x6BC	TxPDO5*, Nd.60
1683	0x693	TxPDO5*, Nd.19	1704	0x6A8	TxPDO5*, Nd.40	1725	0x6BD	TxPDO5*, Nd.61
1684	0x694	TxPDO5*, Nd.20	1705	0x6A9	TxPDO5*, Nd.41	1726	0x6BE	TxPDO5*, Nd.62
1685	0x695	TxPDO5*, Nd.21	1706	0x6AA	TxPDO5*, Nd.42	1727	0x6BF	TxPDO5*, Nd.63

dec	hex	Telegram type	dec	hex	Telegram type	dec	hex	Telegram type
1921	0x781	RxPDO5*, Nd.1	1942	0x796	RxPDO5*, Nd.22	1963	0x7AB	RxPDO5*, Nd.43
1922	0x782	RxPDO5*, Nd.2	1943	0x797	RxPDO5*, Nd.23	1964	0x7AC	RxPDO5*, Nd.44
1923	0x783	RxPDO5*, Nd.3	1944	0x798	RxPDO5*, Nd.24	1965	0x7AD	RxPDO5*, Nd.45
1924	0x784	RxPDO5*, Nd.4	1945	0x799	RxPDO5*, Nd.25	1966	0x7AE	RxPDO5*, Nd.46
1925	0x785	RxPDO5*, Nd.5	1946	0x79A	RxPDO5*, Nd.26	1967	0x7AF	RxPDO5*, Nd.47
1926	0x786	RxPDO5*, Nd.6	1947	0x79B	RxPDO5*, Nd.27	1968	0x7B0	RxPDO5*, Nd.48
1927	0x787	RxPDO5*, Nd.7	1948	0x79C	RxPDO5*, Nd.28	1969	0x7B1	RxPDO5*, Nd.49
1928	0x788	RxPDO5*, Nd.8	1949	0x79D	RxPDO5*, Nd.29	1970	0x7B2	RxPDO5*, Nd.50
1929	0x789	RxPDO5*, Nd.9	1950	0x79E	RxPDO5*, Nd.30	1971	0x7B3	RxPDO5*, Nd.51
1930	0x78A	RxPDO5*, Nd.10	1951	0x79F	RxPDO5*, Nd.31	1972	0x7B4	RxPDO5*, Nd.52
1931	0x78B	RxPDO5*, Nd.11	1952	0x7A0	RxPDO5*, Nd.32	1973	0x7B5	RxPDO5*, Nd.53
1932	0x78C	RxPDO5*, Nd.12	1953	0x7A1	RxPDO5*, Nd.33	1974	0x7B6	RxPDO5*, Nd.54
1933	0x78D	RxPDO5*, Nd.13	1954	0x7A2	RxPDO5*, Nd.34	1975	0x7B7	RxPDO5*, Nd.55
1934	0x78E	RxPDO5*, Nd.14	1955	0x7A3	RxPDO5*, Nd.35	1976	0x7B8	RxPDO5*, Nd.56
1935	0x78F	RxPDO5*, Nd.15	1956	0x7A4	RxPDO5*, Nd.36	1977	0x7B9	RxPDO5*, Nd.57
1936	0x790	RxPDO5*, Nd.16	1957	0x7A5	RxPDO5*, Nd.37	1978	0x7BA	RxPDO5*, Nd.58
1937	0x791	RxPDO5*, Nd.17	1958	0x7A6	RxPDO5*, Nd.38	1979	0x7BB	RxPDO5*, Nd.59
1938	0x792	RxPDO5*, Nd.18	1959	0x7A7	RxPDO5*, Nd.39	1980	0x7BC	RxPDO5*, Nd.60
1939	0x793	RxPDO5*, Nd.19	1960	0x7A8	RxPDO5*, Nd.40	1981	0x7BD	RxPDO5*, Nd.61
1940	0x794	RxPDO5*, Nd.20	1961	0x7A9	RxPDO5*, Nd.41	1982	0x7BE	RxPDO5*, Nd.62
1941	0x795	RxPDO5*, Nd.21	1962	0x7AA	RxPDO5*, Nd.42	1983	0x7BF	RxPDO5*, Nd.63

dec	hex	Telegram type	dec	hex	Telegram type	dec	hex	Telegram type
449	0x1C1	TxPDO6*, Nd.1	470	0x1D6	TxPDO6*, Nd.22	491	0x1EB	TxPDO6*, Nd.43
450	0x1C2	TxPDO6*, Nd.2	471	0x1D7	TxPDO6*, Nd.23	492	0x1EC	TxPDO6*, Nd.44
451	0x1C3	TxPDO6*, Nd.3	472	0x1D8	TxPDO6*, Nd.24	493	0x1ED	TxPDO6*, Nd.45
452	0x1C4	TxPDO6*, Nd.4	473	0x1D9	TxPDO6*, Nd.25	494	0x1EE	TxPDO6*, Nd.46
453	0x1C5	TxPDO6*, Nd.5	474	0x1DA	TxPDO6*, Nd.26	495	0x1EF	TxPDO6*, Nd.47
454	0x1C6	TxPDO6*, Nd.6	475	0x1DB	TxPDO6*, Nd.27	496	0x1F0	TxPDO6*, Nd.48
455	0x1C7	TxPDO6*, Nd.7	476	0x1DC	TxPDO6*, Nd.28	497	0x1F1	TxPDO6*, Nd.49
456	0x1C8	TxPDO6*, Nd.8	477	0x1DD	TxPDO6*, Nd.29	498	0x1F2	TxPDO6*, Nd.50
457	0x1C9	TxPDO6*, Nd.9	478	0x1DE	TxPDO6*, Nd.30	499	0x1F3	TxPDO6*, Nd.51
458	0x1CA	TxPDO6*, Nd.10	479	0x1DF	TxPDO6*, Nd.31	500	0x1F4	TxPDO6*, Nd.52
459	0x1CB	TxPDO6*, Nd.11	480	0x1E0	TxPDO6*, Nd.32	501	0x1F5	TxPDO6*, Nd.53
460	0x1CC	TxPDO6*, Nd.12	481	0x1E1	TxPDO6*, Nd.33	502	0x1F6	TxPDO6*, Nd.54
461	0x1CD	TxPDO6*, Nd.13	482	0x1E2	TxPDO6*, Nd.34	503	0x1F7	TxPDO6*, Nd.55
462	0x1CE	TxPDO6*, Nd.14	483	0x1E3	TxPDO6*, Nd.35	504	0x1F8	TxPDO6*, Nd.56
463	0x1CF	TxPDO6*, Nd.15	484	0x1E4	TxPDO6*, Nd.36	505	0x1F9	TxPDO6*, Nd.57
464	0x1D0	TxPDO6*, Nd.16	485	0x1E5	TxPDO6*, Nd.37	506	0x1FA	TxPDO6*, Nd.58
465	0x1D1	TxPDO6*, Nd.17	486	0x1E6	TxPDO6*, Nd.38	507	0x1FB	TxPDO6*, Nd.59
466	0x1D2	TxPDO6*, Nd.18	487	0x1E7	TxPDO6*, Nd.39	508	0x1FC	TxPDO6*, Nd.60
467	0x1D3	TxPDO6*, Nd.19	488	0x1E8	TxPDO6*, Nd.40	509	0x1FD	TxPDO6*, Nd.61
468	0x1D4	TxPDO6*, Nd.20	489	0x1E9	TxPDO6*, Nd.41	510	0x1FE	TxPDO6*, Nd.62
469	0x1D5	TxPDO6*, Nd.21	490	0x1EA	TxPDO6*, Nd.42	511	0x1FF	TxPDO6*, Nd.63

dec	hex	Telegram type	dec	hex	Telegram type	dec	hex	Telegram type
577	0x241	RxPDO6*, Nd.1	598	0x256	RxPDO6*, Nd.22	619	0x26B	RxPDO6*, Nd.43
578	0x242	RxPDO6*, Nd.2	599	0x257	RxPDO6*, Nd.23	620	0x26C	RxPDO6*, Nd.44
579	0x243	RxPDO6*, Nd.3	600	0x258	RxPDO6*, Nd.24	621	0x26D	RxPDO6*, Nd.45
580	0x244	RxPDO6*, Nd.4	601	0x259	RxPDO6*, Nd.25	622	0x26E	RxPDO6*, Nd.46
581	0x245	RxPDO6*, Nd.5	602	0x25A	RxPDO6*, Nd.26	623	0x26F	RxPDO6*, Nd.47
582	0x246	RxPDO6*, Nd.6	603	0x25B	RxPDO6*, Nd.27	624	0x270	RxPDO6*, Nd.48
583	0x247	RxPDO6*, Nd.7	604	0x25C	RxPDO6*, Nd.28	625	0x271	RxPDO6*, Nd.49
584	0x248	RxPDO6*, Nd.8	605	0x25D	RxPDO6*, Nd.29	626	0x272	RxPDO6*, Nd.50
585	0x249	RxPDO6*, Nd.9	606	0x25E	RxPDO6*, Nd.30	627	0x273	RxPDO6*, Nd.51
586	0x24A	RxPDO6*, Nd.10	607	0x25F	RxPDO6*, Nd.31	628	0x274	RxPDO6*, Nd.52
587	0x24B	RxPDO6*, Nd.11	608	0x260	RxPDO6*, Nd.32	629	0x275	RxPDO6*, Nd.53
588	0x24C	RxPDO6*, Nd.12	609	0x261	RxPDO6*, Nd.33	630	0x276	RxPDO6*, Nd.54
589	0x24D	RxPDO6*, Nd.13	610	0x262	RxPDO6*, Nd.34	631	0x277	RxPDO6*, Nd.55
590	0x24E	RxPDO6*, Nd.14	611	0x263	RxPDO6*, Nd.35	632	0x278	RxPDO6*, Nd.56
591	0x24F	RxPDO6*, Nd.15	612	0x264	RxPDO6*, Nd.36	633	0x279	RxPDO6*, Nd.57
592	0x250	RxPDO6*, Nd.16	613	0x265	RxPDO6*, Nd.3	634	0x27A	RxPDO6*, Nd.58
593	0x251	RxPDO6*, Nd.17	614	0x266	RxPDO6*, Nd.8	635	0x27B	RxPDO6*, Nd.59
594	0x252	RxPDO6*, Nd.18	615	0x267	RxPDO6*, Nd.39	636	0x27C	RxPDO6*, Nd.60
595	0x253	RxPDO6*, Nd.19	616	0x268	RxPDO6*, N.40	637	0x27D	RxPDO6*, Nd.61
596	0x254	RxPDO6*, Nd.20	617	0x269	RxPDO6*, d.41	638	0x27E	RxPDO6*, Nd.62
597	0x255	RxPDO6*, Nd.21	618	0x26A	RxPDO6*,Nd.42	639	0x27F	RxPDO6*, Nd.63

dec	hex	Telegram type	dec	hex	Telegram type	dec	hex	Telegram type
705	0x2C1	TxPDO7*, Nd.1	726	0x2D6	TxPDO7*, Nd.22	747	0x2EB	TxPDO7*, Nd.43
706	0x2C2	TxPDO7*, Nd.2	727	0x2D7	TxPDO7*, Nd.23	748	0x2EC	TxPDO7*, Nd.44
707	0x2C3	TxPDO7*, Nd.3	728	0x2D8	TxPDO7*, Nd.24	749	0x2ED	TxPDO7*, Nd.45
708	0x2C4	TxPDO7*, Nd.4	729	0x2D9	TxPDO7*, Nd.25	750	0x2EE	TxPDO7*, Nd.46
709	0x2C5	TxPDO7*, Nd.5	730	0x2DA	TxPDO7*, Nd.26	751	0x2EF	TxPDO7*, Nd.47
710	0x2C6	TxPDO7*, Nd.6	731	0x2DB	TxPDO7*, Nd.27	752	0x2F0	TxPDO7*, Nd.48
711	0x2C7	TxPDO7*, Nd.7	732	0x2DC	TxPDO7*, Nd.28	753	0x2F1	TxPDO7*, Nd.49
712	0x2C8	TxPDO7*, Nd.8	733	0x2DD	TxPDO7*, Nd.29	754	0x2F2	TxPDO7*, Nd.50
713	0x2C9	TxPDO7*, Nd.9	734	0x2DE	TxPDO7*, Nd.30	755	0x2F3	TxPDO7*, Nd.51
714	0x2CA	TxPDO7*, Nd.10	735	0x2DF	TxPDO7*, Nd.31	756	0x2F4	TxPDO7*, Nd.52
715	0x2CB	TxPDO7*, Nd.11	736	0x2E0	TxPDO7*, Nd.32	757	0x2F5	TxPDO7*, Nd.53
716	0x2CC	TxPDO7*, Nd.12	737	0x2E1	TxPDO7*, Nd.33	758	0x2F6	TxPDO7*, Nd.54
717	0x2CD	TxPDO7*, Nd.13	738	0x2E2	TxPDO7*, Nd.34	759	0x2F7	TxPDO7*, Nd.55
718	0x2CE	TxPDO7*, Nd.14	739	0x2E3	TxPDO7*, Nd.35	760	0x2F8	TxPDO7*, Nd.56
719	0x2CF	TxPDO7*, Nd.15	740	0x2E4	TxPDO7*, Nd.36	761	0x2F9	TxPDO7*, Nd.57
720	0x2D0	TxPDO7*, Nd.16	741	0x2E5	TxPDO7*, Nd.37	762	0x2FA	TxPDO7*, Nd.58
721	0x2D1	TxPDO7*, Nd.17	742	0x2E6	TxPDO7*, Nd.38	763	0x2FB	TxPDO7*, Nd.59
722	0x2D2	TxPDO7*, Nd.18	743	0x2E7	TxPDO7*, Nd.39	764	0x2FC	TxPDO7*, Nd.60
723	0x2D3	TxPDO7*, Nd.19	744	0x2E8	TxPDO7*, Nd.40	765	0x2FD	TxPDO7*, Nd.61
724	0x2D4	TxPDO7*, Nd.20	745	0x2E9	TxPDO7*, Nd.41	766	0x2FE	TxPDO7*, Nd.62
725	0x2D5	TxPDO7*, Nd.21	746	0x2EA	TxPDO7*, Nd.42	767	0x2FF	TxPDO7*, Nd.63

dec	hex	Telegram type	dec	hex	Telegram type	dec	hex	Telegram type
833	0x341	RxPDO7*, Nd.1	854	0x356	RxPDO7*, Nd.22	875	0x36B	RxPDO7*, Nd.43
834	0x342	RxPDO7*, Nd.2	855	0x357	RxPDO7*, Nd.23	876	0x36C	RxPDO7*, Nd.44
835	0x343	RxPDO7*, Nd.3	856	0x358	RxPDO7*, Nd.24	877	0x36D	RxPDO7*, Nd.45
836	0x344	RxPDO7*, Nd.4	857	0x359	RxPDO7*, Nd.25	878	0x36E	RxPDO7*, Nd.46
837	0x345	RxPDO7*, Nd.5	858	0x35A	RxPDO7*, Nd.26	879	0x36F	RxPDO7*, Nd.47
838	0x346	RxPDO7*, Nd.6	859	0x35B	RxPDO7*, Nd.27	880	0x370	RxPDO7*, Nd.48
839	0x347	RxPDO7*, Nd.7	860	0x35C	RxPDO7*, Nd.28	881	0x371	RxPDO7*, Nd.49
840	0x348	RxPDO7*, Nd.8	861	0x35D	RxPDO7*, Nd.29	882	0x372	RxPDO7*, Nd.50
841	0x349	RxPDO7*, Nd.9	862	0x35E	RxPDO7*, Nd.30	883	0x373	RxPDO7*, Nd.51
842	0x34A	RxPDO7*, Nd.10	863	0x35F	RxPDO7*, Nd.31	884	0x374	RxPDO7*, Nd.52
843	0x34B	RxPDO7*, Nd.11	864	0x360	RxPDO7*, Nd.32	885	0x375	RxPDO7*, Nd.53
844	0x34C	RxPDO7*, Nd.12	865	0x361	RxPDO7*, Nd.33	886	0x376	RxPDO7*, Nd.54
845	0x34D	RxPDO7*, Nd.13	866	0x362	RxPDO7*, Nd.34	887	0x377	RxPDO7*, Nd.55
846	0x34E	RxPDO7*, Nd.14	867	0x363	RxPDO7*, Nd.35	888	0x378	RxPDO7*, Nd.56
847	0x34F	RxPDO7*, Nd.15	868	0x364	RxPDO7*, Nd.36	889	0x379	RxPDO7*, Nd.57
848	0x350	RxPDO7*, Nd.16	869	0x365	RxPDO7*, Nd.37	890	0x37A	RxPDO7*, Nd.58
849	0x351	RxPDO7*, Nd.17	870	0x366	RxPDO7*, Nd.38	891	0x37B	RxPDO7*, Nd.59
850	0x352	RxPDO7*, Nd.18	871	0x367	RxPDO7*, Nd.39	892	0x37C	RxPDO7*, Nd.60
851	0x353	RxPDO7*, Nd.19	872	0x368	RxPDO7*, Nd.40	893	0x37D	RxPDO7*, Nd.61
852	0x354	RxPDO7*, Nd.20	873	0x369	RxPDO7*, Nd.41	894	0x37E	RxPDO7*, Nd.62
853	0x355	RxPDO7*, Nd.21	874	0x36A	RxPDO7*, Nd.42	895	0x37F	RxPDO7*, Nd.63

dec	hex	Telegram type	dec	hex	Telegram type	dec	hex	Telegram type
961	0x3C1	TxPDO8*, Nd.1	982	0x3D6	TxPDO8*, Nd.22	1003	0x3EB	TxPDO8*, Nd.43
962	0x3C2	TxPDO8*, Nd.2	983	0x3D7	TxPDO8*, Nd.23	1004	0x3EC	TxPDO8*, Nd.44
963	0x3C3	TxPDO8*, Nd.3	984	0x3D8	TxPDO8*, Nd.24	1005	0x3ED	TxPDO8*, Nd.45
964	0x3C4	TxPDO8*, Nd.4	985	0x3D9	TxPDO8*, Nd.25	1006	0x3EE	TxPDO8*, Nd.46
965	0x3C5	TxPDO8*, Nd.5	986	0x3DA	TxPDO8*, Nd.26	1007	0x3EF	TxPDO8*, Nd.47
966	0x3C6	TxPDO8*, Nd.6	987	0x3DB	TxPDO8*, Nd.27	1008	0x3F0	TxPDO8*, Nd.48
967	0x3C7	TxPDO8*, Nd.7	988	0x3DC	TxPDO8*, Nd.28	1009	0x3F1	TxPDO8*, Nd.49
968	0x3C8	TxPDO8*, Nd.8	989	0x3DD	TxPDO8*, Nd.29	1010	0x3F2	TxPDO8*, Nd.50
969	0x3C9	TxPDO8*, Nd.9	990	0x3DE	TxPDO8*, Nd.30	1011	0x3F3	TxPDO8*, Nd.51
970	0x3CA	TxPDO8*, Nd.10	991	0x3DF	TxPDO8*, Nd.31	1012	0x3F4	TxPDO8*, Nd.52
971	0x3CB	TxPDO8*, Nd.11	992	0x3E0	TxPDO8*, Nd.32	1013	0x3F5	TxPDO8*, Nd.53
972	0x3CC	TxPDO8*, Nd.12	993	0x3E1	TxPDO8*, Nd.33	1014	0x3F6	TxPDO8*, Nd.54
973	0x3CD	TxPDO8*, Nd.13	994	0x3E2	TxPDO8*, Nd.34	1015	0x3F7	TxPDO8*, Nd.55
974	0x3CE	TxPDO8*, Nd.14	995	0x3E3	TxPDO8*, Nd.35	1016	0x3F8	TxPDO8*, Nd.56
975	0x3CF	TxPDO8*, Nd.15	996	0x3E4	TxPDO8*, Nd.36	1017	0x3F9	TxPDO8*, Nd.57
976	0x3D0	TxPDO8*, Nd.16	997	0x3E5	TxPDO8*, Nd.37	1018	0x3FA	TxPDO8*, Nd.58
977	0x3D1	TxPDO8*, Nd.17	998	0x3E6	TxPDO8*, Nd.38	1019	0x3FB	TxPDO8*, Nd.59
978	0x3D2	TxPDO8*, Nd.18	999	0x3E7	TxPDO8*, Nd.39	1020	0x3FC	TxPDO8*, Nd.60
979	0x3D3	TxPDO8*, Nd.19	1000	0x3E8	TxPDO8*, Nd.40	1021	0x3FD	TxPDO8*, Nd.61
980	0x3D4	TxPDO8*, Nd.20	1001	0x3E9	TxPDO8*, Nd.41	1022	0x3FE	TxPDO8*, Nd.62
981	0x3D5	TxPDO8*, Nd.21	1002	0x3EA	TxPDO8*, Nd.42	1023	0x3FF	TxPDO8*, Nd.63

dec	hex	Telegram type	dec	hex	Telegram type	dec	hex	Telegram type
1089	0x441	RxPDO8*, Nd.1	1110	0x456	RxPDO8*, Nd.22	1131	0x46B	RxPDO8*, Nd.43
1090	0x442	RxPDO8*, Nd.2	1111	0x457	RxPDO8*, Nd.23	1132	0x46C	RxPDO8*, Nd.44
1091	0x443	RxPDO8*, Nd.3	1112	0x458	RxPDO8*, Nd.24	1133	0x46D	RxPDO8*, Nd.45
1092	0x444	RxPDO8*, Nd.4	1113	0x459	RxPDO8*, Nd.25	1134	0x46E	RxPDO8*, Nd.46
1093	0x445	RxPDO8*, Nd.5	1114	0x45A	RxPDO8*, Nd.26	1135	0x46F	RxPDO8*, Nd.47
1094	0x446	RxPDO8*, Nd.6	1115	0x45B	RxPDO8*, Nd.27	1136	0x470	RxPDO8*, Nd.48
1095	0x447	RxPDO8*, Nd.7	1116	0x45C	RxPDO8*, Nd.28	1137	0x471	RxPDO8*, Nd.49
1096	0x448	RxPDO8*, Nd.8	1117	0x45D	RxPDO8*, Nd.29	1138	0x472	RxPDO8*, Nd.50
1097	0x449	RxPDO8*, Nd.9	1118	0x45E	RxPDO8*, Nd.30	1139	0x473	RxPDO8*, Nd.51
1098	0x44A	RxPDO8*, Nd.10	1119	0x45F	RxPDO8*, Nd.31	1140	0x474	RxPDO8*, Nd.52
1099	0x44B	RxPDO8*, Nd.11	1120	0x460	RxPDO8*, Nd.32	1141	0x475	RxPDO8*, Nd.53
1100	0x44C	RxPDO8*, Nd.12	1121	0x461	RxPDO8*, Nd.33	1142	0x476	RxPDO8*, Nd.54
1101	0x44D	RxPDO8*, Nd.13	1122	0x462	RxPDO8*, Nd.34	1143	0x477	RxPDO8*, Nd.55
1102	0x44E	RxPDO8*, Nd.14	1123	0x463	RxPDO8*, Nd.35	1144	0x478	RxPDO8*, Nd.56
1103	0x44F	RxPDO8*, Nd.15	1124	0x464	RxPDO8*, Nd.36	1145	0x479	RxPDO8*, Nd.57
1104	0x450	RxPDO8*, Nd.16	1125	0x465	RxPDO8*, Nd.37	1146	0x47A	RxPDO8*, Nd.58
1105	0x451	RxPDO8*, Nd.17	1126	0x466	RxPDO8*, Nd.38	1147	0x47B	RxPDO8*, Nd.59
1106	0x452	RxPDO8*, Nd.18	1127	0x467	RxPDO8*, Nd.39	1148	0x47C	RxPDO8*, Nd.60
1107	0x453	RxPDO8*, Nd.19	1128	0x468	RxPDO8*, Nd.40	1149	0x47D	RxPDO8*, Nd.61
1108	0x454	RxPDO8*, Nd.20	1129	0x469	RxPDO8*, Nd.41	1150	0x47E	RxPDO8*, Nd.62
1109	0x455	RxPDO8*, Nd.21	1130	0x46A	RxPDO8*, Nd.42	1151	0x47F	RxPDO8*, Nd.63

dec	hex	Telegram type	dec	hex	Telegram type	dec	hex	Telegram type
1217	0x4C1	TxPDO9*, Nd.1	1238	0x4D6	TxPDO9*, Nd.22	1259	0x4EB	TxPDO9*, Nd.43
1218	0x4C2	TxPDO9*, Nd.2	1239	0x4D7	TxPDO9*, Nd.23	1260	0x4EC	TxPDO9*, Nd.44
1219	0x4C3	TxPDO9*, Nd.3	1240	0x4D8	TxPDO9*, Nd.24	1261	0x4ED	TxPDO9*, Nd.45
1220	0x4C4	TxPDO9*, Nd.4	1241	0x4D9	TxPDO9*, Nd.25	1262	0x4EE	TxPDO9*, Nd.46
1221	0x4C5	TxPDO9*, Nd.5	1242	0x4DA	TxPDO9*, Nd.26	1263	0x4EF	TxPDO9*, Nd.47
1222	0x4C6	TxPDO9*, Nd.6	1243	0x4DB	TxPDO9*, Nd.27	1264	0x4F0	TxPDO9*, Nd.48
1223	0x4C7	TxPDO9*, Nd.7	1244	0x4DC	TxPDO9*, Nd.28	1265	0x4F1	TxPDO9*, Nd.49
1224	0x4C8	TxPDO9*, Nd.8	1245	0x4DD	TxPDO9*, Nd.29	1266	0x4F2	TxPDO9*, Nd.50
1225	0x4C9	TxPDO9*, Nd.9	1246	0x4DE	TxPDO9*, Nd.30	1267	0x4F3	TxPDO9*, Nd.51
1226	0x4CA	TxPDO9*, Nd.10	1247	0x4DF	TxPDO9*, Nd.31	1268	0x4F4	TxPDO9*, Nd.52
1227	0x4CB	TxPDO9*, Nd.11	1248	0x4E0	TxPDO9*, Nd.32	1269	0x4F5	TxPDO9*, Nd.53
1228	0x4CC	TxPDO9*, Nd.12	1249	0x4E1	TxPDO9*, Nd.33	1270	0x4F6	TxPDO9*, Nd.54
1229	0x4CD	TxPDO9*, Nd.13	1250	0x4E2	TxPDO9*, Nd.34	1271	0x4F7	TxPDO9*, Nd.55
1230	0x4CE	TxPDO9*, Nd.14	1251	0x4E3	TxPDO9*, Nd.35	1272	0x4F8	TxPDO9*, Nd.56
1231	0x4CF	TxPDO9*, Nd.15	1252	0x4E4	TxPDO9*, Nd.36	1273	0x4F9	TxPDO9*, Nd.57
1232	0x4D0	TxPDO9*, Nd.16	1253	0x4E5	TxPDO9*, Nd.37	1274	0x4FA	TxPDO9*, Nd.58
1233	0x4D1	TxPDO9*, Nd.17	1254	0x4E6	TxPDO9*, Nd.38	1275	0x4FB	TxPDO9*, Nd.59
1234	0x4D2	TxPDO9*, Nd.18	1255	0x4E7	TxPDO9*, Nd.39	1276	0x4FC	TxPDO9*, Nd.60
1235	0x4D3	TxPDO9*, Nd.19	1256	0x4E8	TxPDO9*, Nd.40	1277	0x4FD	TxPDO9*, Nd.61
1236	0x4D4	TxPDO9*, Nd.20	1257	0x4E9	TxPDO9*, Nd.41	1278	0x4FE	TxPDO9*, Nd.62
1237	0x4D5	TxPDO9*, Nd.21	1258	0x4EA	TxPDO9*, Nd.42	1279	0x4FF	TxPDO9*, Nd.63

dec	hex	Telegram type	dec	hex	Telegram type	dec	hex	Telegram type
1345	0x541	RxPDO9*, Nd.1	1366	0x556	RxPDO9*, Nd.22	1387	0x56B	RxPDO9*, Nd.43
1346	0x542	RxPDO9*, Nd.2	1367	0x557	RxPDO9*, Nd.23	1388	0x56C	RxPDO9*, Nd.44
1347	0x543	RxPDO9*, Nd.3	1368	0x558	RxPDO9*, Nd.24	1389	0x56D	RxPDO9*, Nd.45
1348	0x544	RxPDO9*, Nd.4	1369	0x559	RxPDO9*, Nd.25	1390	0x56E	RxPDO9*, Nd.46
1349	0x545	RxPDO9*, Nd.5	1370	0x55A	RxPDO9*, Nd.26	1391	0x56F	RxPDO9*, Nd.47
1350	0x546	RxPDO9*, Nd.6	1371	0x55B	RxPDO9*, Nd.27	1392	0x570	RxPDO9*, Nd.48
1351	0x547	RxPDO9*, Nd.7	1372	0x55C	RxPDO9*, Nd.28	1393	0x571	RxPDO9*, Nd.49
1352	0x548	RxPDO9*, Nd.8	1373	0x55D	RxPDO9*, Nd.29	1394	0x572	RxPDO9*, Nd.50
1353	0x549	RxPDO9*, Nd.9	1374	0x55E	RxPDO9*, Nd.30	1395	0x573	RxPDO9*, Nd.51
1354	0x54A	RxPDO9*, Nd.10	1375	0x55F	RxPDO9*, Nd.31	1396	0x574	RxPDO9*, Nd.52
1355	0x54B	RxPDO9*, Nd.11	1376	0x560	RxPDO9*, Nd.32	1397	0x575	RxPDO9*, Nd.53
1356	0x54C	RxPDO9*, Nd.12	1377	0x561	RxPDO9*, Nd.33	1398	0x576	RxPDO9*, Nd.54
1357	0x54D	RxPDO9*, Nd.13	1378	0x562	RxPDO9*, Nd.34	1399	0x577	RxPDO9*, Nd.55
1358	0x54E	RxPDO9*, Nd.14	1379	0x563	RxPDO9*, Nd.35	1400	0x578	RxPDO9*, Nd.56
1359	0x54F	RxPDO9*, Nd.15	1380	0x564	RxPDO9*, Nd.36	1401	0x579	RxPDO9*, Nd.57
1360	0x550	RxPDO9*, Nd.16	1381	0x565	RxPDO9*, Nd.37	1402	0x57A	RxPDO9*, Nd.58
1361	0x551	RxPDO9*, Nd.17	1382	0x566	RxPDO9*, Nd.38	1403	0x57B	RxPDO9*, Nd.59
1362	0x552	RxPDO9*, Nd.18	1383	0x567	RxPDO9*, Nd.39	1404	0x57C	RxPDO9*, Nd.60
1363	0x553	RxPDO9*, Nd.19	1384	0x568	RxPDO9*, Nd.40	1405	0x57D	RxPDO9*, Nd.61
1364	0x554	RxPDO9*, Nd.20	1385	0x569	RxPDO9*, Nd.41	1406	0x57E	RxPDO9*, Nd.62
1365	0x555	RxPDO9*, Nd.21	1386	0x56A	RxPDO9*, Nd.42	1407	0x57F	RxPDO9*, Nd.63

dec	hex	Telegram type	dec	hex	Telegram type	dec	hex	Telegram type
1473	0x5C1	TxPDO10*, Nd.1	1494	0x5D6	TxPDO10*, Nd.22	1515	0x5EB	TxPDO10*, Nd.43
1474	0x5C2	TxPDO10*, Nd.2	1495	0x5D7	TxPDO10*, Nd.23	1516	0x5EC	TxPDO10*, Nd.44
1475	0x5C3	TxPDO10*, Nd.3	1496	0x5D8	TxPDO10*, Nd.24	1517	0x5ED	TxPDO10*, Nd.45
1476	0x5C4	TxPDO10*, Nd.4	1497	0x5D9	TxPDO10*, Nd.25	1518	0x5EE	TxPDO10*, Nd.46
1477	0x5C5	TxPDO10*, Nd.5	1498	0x5DA	TxPDO10*, Nd.26	1519	0x5EF	TxPDO10*, Nd.47
1478	0x5C6	TxPDO10*, Nd.6	1499	0x5DB	TxPDO10*, Nd.27	1520	0x5F0	TxPDO10*, Nd.48
1479	0x5C7	TxPDO10*, Nd.7	1500	0x5DC	TxPDO10*, Nd.28	1521	0x5F1	TxPDO10*, Nd.49
1480	0x5C8	TxPDO10*, Nd.8	1501	0x5DE	TxPDO10*, Nd.29	1522	0x5F2	TxPDO10*, Nd.50
1481	0x5C9	TxPDO10*, Nd.9	1502	0x5DE	TxPDO10*, Nd.30	1523	0x5F3	TxPDO10*, Nd.51
1482	0x5CA	TxPDO10*, Nd.10	1503	0x5DF	TxPDO10*, Nd.31	1524	0x5F4	TxPDO10*, Nd.52
1483	0x5CB	TxPDO10*, Nd.11	1504	0x5E0	TxPDO10*, Nd.32	1525	0x5F5	TxPDO10*, Nd.53
1484	0x5CC	TxPDO10*, Nd.12	1505	0x5E1	TxPDO10*, Nd.33	1526	0x5F6	TxPDO10*, Nd.54
1485	0x5CD	TxPDO10*, Nd.13	1506	0x5E2	TxPDO10*, Nd.34	1527	0x5F7	TxPDO10*, Nd.55
1486	0x5CE	TxPDO10*, Nd.14	1507	0x5E3	TxPDO10*, Nd.35	1528	0x5F8	TxPDO10*, Nd.56
1487	0x5CF	TxPDO10*, Nd.15	1508	0x5E4	TxPDO10*, Nd.36	1529	0x5F9	TxPDO10*, Nd.57
1488	0x5D0	TxPDO10*, Nd.16	1509	0x5E5	TxPDO10*, Nd.37	1530	0x5FA	TxPDO10*, Nd.58
1489	0x5D1	TxPDO10*, Nd.17	1510	0x5E6	TxPDO10*, Nd.38	1531	0x5FB	TxPDO10*, Nd.59
1490	0x5D2	TxPDO10*, Nd.18	1511	0x5E7	TxPDO10*, Nd.39	1532	0x5FC	TxPDO10*, Nd.60
1491	0x5D3	TxPDO10*, Nd.19	1512	0x5E8	TxPDO10*, Nd.40	1533	0x5FD	TxPDO10*, Nd.61
1492	0x5D4	TxPDO10*, Nd.20	1513	0x5E9	TxPDO10*, Nd.41	1534	0x5FE	TxPDO10*, Nd.62
1493	0x5D5	TxPDO10*, Nd.21	1514	0x5EA	TxPDO10*, Nd.42	1535	0x5FF	TxPDO10*, Nd.63

dec	hex	Telegram type	dec	hex	Telegram type	dec	hex	Telegram type
1601	0x641	RxPDO10*, Nd.1	1622	0x656	RxPDO10*, Nd.22	1643	0x66B	RxPDO10*, Nd.43
1602	0x642	RxPDO10*, Nd.2	1623	0x657	RxPDO10*, Nd.23	1644	0x66C	RxPDO10*, Nd.44
1603	0x643	RxPDO10*, Nd.3	1624	0x658	RxPDO10*, Nd.24	1645	0x66D	RxPDO10*, Nd.45
1604	0x644	RxPDO10*, Nd.4	1625	0x659	RxPDO10*, Nd.25	1646	0x66E	RxPDO10*, Nd.46
1605	0x645	RxPDO10*, Nd.5	1626	0x65A	RxPDO10*, Nd.26	1647	0x66F	RxPDO10*, Nd.47
1606	0x646	RxPDO10*, Nd.6	1627	0x65B	RxPDO10*, Nd.27	1648	0x670	RxPDO10*, Nd.48
1607	0x647	RxPDO10*, Nd.7	1628	0x65C	RxPDO10*, Nd.28	1649	0x671	RxPDO10*, Nd.49
1608	0x648	RxPDO10*, Nd.8	1629	0x65D	RxPDO10*, Nd.29	1650	0x672	RxPDO10*, Nd.50
1609	0x649	RxPDO10*, Nd.9	1630	0x65E	RxPDO10*, Nd.30	1651	0x673	RxPDO10*, Nd.51
1610	0x64A	RxPDO10*, Nd.10	1631	0x65F	RxPDO10*, Nd.31	1652	0x674	RxPDO10*, Nd.52
1611	0x64B	RxPDO10*, Nd.11	1632	0x660	RxPDO10*, Nd.32	1653	0x675	RxPDO10*, Nd.53
1612	0x64C	RxPDO10*, Nd.12	1633	0x661	RxPDO10*, Nd.33	1654	0x676	RxPDO10*, Nd.54
1613	0x64D	RxPDO10*, Nd.13	1634	0x662	RxPDO10*, Nd.34	1655	0x677	RxPDO10*, Nd.55
1614	0x64E	RxPDO10*, Nd.14	1635	0x663	RxPDO10*, Nd.35	1656	0x678	RxPDO10*, Nd.56
1615	0x64F	RxPDO10*, Nd.15	1636	0x664	RxPDO10*, Nd.36	1657	0x679	RxPDO10*, Nd.57
1616	0x650	RxPDO10*, Nd.16	1637	0x665	RxPDO10*, Nd.37	1658	0x67A	RxPDO10*, Nd.58
1617	0x651	RxPDO10*, Nd.17	1638	0x666	RxPDO10*, Nd.38	1659	0x67B	RxPDO10*, Nd.59
1618	0x652	RxPDO10*, Nd.18	1639	0x667	RxPDO10*, Nd.39	1660	0x67C	RxPDO10*, Nd.60
1619	0x653	RxPDO10*, Nd.19	1640	0x668	RxPDO10*, Nd.40	1661	0x67D	RxPDO10*, Nd.61
1620	0x654	RxPDO10*, Nd.20	1641	0x669	RxPDO10*, Nd.41	1662	0x67E	RxPDO10*, Nd.62
1621	0x655	RxPDO10*, Nd.21	1642	0x66A	RxPDO10*, Nd.42	1663	0x67F	RxPDO10*, Nd.63

dec	hex	Telegram type	dec	hex	Telegram type	dec	hex	Telegram type
1729	0x6C1	TxPDO11*, Nd.1	1750	0x6D6	TxPDO11*, Nd.22	1771	0x6EB	TxPDO11*, Nd.43
1730	0x6C2	TxPDO11*, Nd.2	1751	0x6D7	TxPDO11*, Nd.23	1772	0x6EC	TxPDO11*, Nd.44
1731	0x6C3	TxPDO11*, Nd.3	1752	0x6D8	TxPDO11*, Nd.24	1773	0x6ED	TxPDO11*, Nd.45
1732	0x6C4	TxPDO11*, Nd.4	1753	0x6D9	TxPDO11*, Nd.25	1774	0x6EE	TxPDO11*, Nd.46
1733	0x6C5	TxPDO11*, Nd.5	1754	0x6DA	TxPDO11*, Nd.26	1775	0x6EF	TxPDO11*, Nd.47
1734	0x6C6	TxPDO11*, Nd.6	1755	0x6DB	TxPDO11*, Nd.27	1776	0x6F0	TxPDO11*, Nd.48
1735	0x6C7	TxPDO11*, Nd.7	1756	0x6DC	TxPDO11*, Nd.28	1777	0x6F1	TxPDO11*, Nd.49
1736	0x6C8	TxPDO11*, Nd.8	1757	0x6DD	TxPDO11*, Nd.29	1778	0x6F2	TxPDO11*, Nd.50
1737	0x6C9	TxPDO11*, Nd.9	1758	0x6DE	TxPDO11*, Nd.30	1779	0x6F3	TxPDO11*, Nd.51
1738	0x6CA	TxPDO11*, Nd.10	1759	0x6DF	TxPDO11*, Nd.31	1780	0x6F4	TxPDO11*, Nd.52
1739	0x6CB	TxPDO11*, Nd.11	1760	0x6E0	TxPDO11*, Nd.32	1781	0x6F5	TxPDO11*, Nd.53
1740	0x6CC	TxPDO11*, Nd.12	1761	0x6E1	TxPDO11*, Nd.33	1782	0x6F6	TxPDO11*, Nd.54
1741	0x6CD	TxPDO11*, Nd.13	1762	0x6E2	TxPDO11*, Nd.34	1783	0x6F7	TxPDO11*, Nd.55
1742	0x6CE	TxPDO11*, Nd.14	1763	0x6E3	TxPDO11*, Nd.35	1784	0x6F8	TxPDO11*, Nd.56
1743	0x6CF	TxPDO11*, Nd.15	1764	0x6E4	TxPDO11*, Nd.36	1785	0x6F9	TxPDO11*, Nd.57
1744	0x6D0	TxPDO11*, Nd.16	1765	0x6E5	TxPDO11*, Nd.37	1786	0x6FA	TxPDO11*, Nd.58
1745	0x6D1	TxPDO11*, Nd.17	1766	0x6E6	TxPDO11*, Nd.38	1787	0x6FB	TxPDO11*, Nd.59
1746	0x6D2	TxPDO11*, Nd.18	1767	0x6E7	TxPDO11*, Nd.39	1788	0x6FC	TxPDO11*, Nd.60
1747	0x6D3	TxPDO11*, Nd.19	1768	0x6E8	TxPDO11*, Nd.40	1789	0x6FD	TxPDO11*, Nd.61
1748	0x6D4	TxPDO11*, Nd.20	1769	0x6E9	TxPDO11*, Nd.41	1790	0x6FE	TxPDO11*, Nd.62
1749	0x6D5	TxPDO11*, Nd.21	1770	0x6EA	TxPDO11*, Nd.42	1791	0x6FF	TxPDO11*, Nd.63

dec	hex	Telegram type	dec	hex	Telegram type	dec	hex	Telegram type
1857	0x741	RxPDO11*, Nd.1	1878	0x756	RxPDO11*, Nd.22	1899	0x76B	RxPDO11*, Nd.43
1858	0x742	RxPDO11*, Nd.2	1879	0x757	RxPDO11*, Nd.23	1900	0x76C	RxPDO11*, Nd.44
1859	0x743	RxPDO11*, Nd.3	1880	0x758	RxPDO11*, Nd.24	1901	0x76D	RxPDO11*, Nd.45
1860	0x744	RxPDO11*, Nd.4	1881	0x759	RxPDO11*, Nd.25	1902	0x76E	RxPDO11*, Nd.46
1861	0x745	RxPDO11*, Nd.5	1882	0x75A	RxPDO11*, Nd.26	1903	0x76F	RxPDO11*, Nd.47
1862	0x746	RxPDO11*, Nd.6	1883	0x75B	RxPDO11*, Nd.27	1904	0x770	RxPDO11*, Nd.48
1863	0x747	RxPDO11*, Nd.7	1884	0x75C	RxPDO11*, Nd.28	1905	0x771	RxPDO11*, Nd.49
1864	0x748	RxPDO11*, Nd.8	1885	0x75D	RxPDO11*, Nd.29	1906	0x772	RxPDO11*, Nd.50
1865	0x749	RxPDO11*, Nd.9	1886	0x75E	RxPDO11*, Nd.30	1907	0x773	RxPDO11*, Nd.51
1866	0x74A	RxPDO11*, Nd.10	1887	0x75F	RxPDO11*, Nd.31	1908	0x774	RxPDO11*, Nd.52
1867	0x74B	RxPDO11*, Nd.11	1888	0x760	RxPDO11*, Nd.32	1909	0x775	RxPDO11*, Nd.53
1868	0x74C	RxPDO11*, Nd.12	1889	0x761	RxPDO11*, Nd.33	1910	0x776	RxPDO11*, Nd.54
1869	0x74D	RxPDO11*, Nd.13	1890	0x762	RxPDO11*, Nd.34	1911	0x777	RxPDO11*, Nd.55
1870	0x74E	RxPDO11*, Nd.14	1891	0x763	RxPDO11*, Nd.35	1912	0x778	RxPDO11*, Nd.56
1871	0x74F	RxPDO11*, Nd.15	1892	0x764	RxPDO11*, Nd.36	1913	0x779	RxPDO11*, Nd.57
1872	0x750	RxPDO11*, Nd.16	1893	0x765	RxPDO11*, Nd.37	1914	0x77A	RxPDO11*, Nd.58
1873	0x751	RxPDO11*, Nd.17	1894	0x766	RxPDO11*, Nd.38	1915	0x77B	RxPDO11*, Nd.59
1874	0x752	RxPDO11*, Nd.18	1895	0x767	RxPDO11*, Nd.39	1916	0x77C	RxPDO11*, Nd.60
1875	0x753	RxPDO11*, Nd.19	1896	0x768	RxPDO11*, Nd.40	1917	0x77D	RxPDO11*, Nd.61
1876	0x754	RxPDO11*, Nd.20	1897	0x769	RxPDO11*, Nd.41	1918	0x77E	RxPDO11*, Nd.62
1877	0x755	RxPDO11*, Nd.21	1898	0x76A	RxPDO11*, Nd.42	1919	0x77F	RxPDO11*, Nd.63

dec	hex	Telegram type	dec	hex	Telegram type	dec	hex	Telegram type
1409	0x581	SDO Tx Nd.1	1430	0x596	SDO Tx Nd.22	1451	0x5AB	SDO Tx Nd.43
1410	0x582	SDO Tx Nd.2	1431	0x597	SDO Tx Nd.23	1452	0x5AC	SDO Tx Nd.44
1411	0x583	SDO Tx Nd.3	1432	0x598	SDO Tx Nd.24	1453	0x5AD	SDO Tx Nd.45
1412	0x584	SDO Tx Nd.4	1433	0x599	SDO Tx Nd.25	1454	0x5AE	SDO Tx Nd.46
1413	0x585	SDO Tx Nd.5	1434	0x59A	SDO Tx Nd.26	1455	0x5AF	SDO Tx Nd.47
1414	0x586	SDO Tx Nd.6	1435	0x59B	SDO Tx Nd.27	1456	0x5B0	SDO Tx Nd.48
1415	0x587	SDO Tx Nd.7	1436	0x59C	SDO Tx Nd.28	1457	0x5B1	SDO Tx Nd.49
1416	0x588	SDO Tx Nd.8	1437	0x59D	SDO Tx Nd.29	1458	0x5B2	SDO Tx Nd.50
1417	0x589	SDO Tx Nd.9	1438	0x59E	SDO Tx Nd.30	1459	0x5B3	SDO Tx Nd.51
1418	0x58A	SDO Tx Nd.10	1439	0x59F	SDO Tx Nd.31	1460	0x5B4	SDO Tx Nd.52
1419	0x58B	SDO Tx Nd.11	1440	0x5A0	SDO Tx Nd.32	1461	0x5B5	SDO Tx Nd.53
1420	0x58C	SDO Tx Nd.12	1441	0x5A1	SDO Tx Nd.33	1462	0x5B6	SDO Tx Nd.54
1421	0x58D	SDO Tx Nd.13	1442	0x5A2	SDO Tx Nd.34	1463	0x5B7	SDO Tx Nd.55
1422	0x58E	SDO Tx Nd.14	1443	0x5A3	SDO Tx Nd.35	1464	0x5B8	SDO Tx Nd.56
1423	0x58F	SDO Tx Nd.15	1444	0x5A4	SDO Tx Nd.36	1465	0x5B9	SDO Tx Nd.57
1424	0x590	SDO Tx Nd.16	1445	0x5A5	SDO Tx Nd.37	1466	0x5BA	SDO Tx Nd.58
1425	0x591	SDO Tx Nd.17	1446	0x5A6	SDO Tx Nd.38	1467	0x5BB	SDO Tx Nd.59
1426	0x592	SDO Tx Nd.18	1447	0x5A7	SDO Tx Nd.39	1468	0x5BC	SDO Tx Nd.60
1427	0x593	SDO Tx Nd.19	1448	0x5A8	SDO Tx Nd.40	1469	0x5BD	SDO Tx Nd.61
1428	0x594	SDO Tx Nd.20	1449	0x5A9	SDO Tx Nd.41	1470	0x5BE	SDO Tx Nd.62
1429	0x595	SDO Tx Nd.21	1450	0x5AA	SDO Tx Nd.42	1471	0x5BF	SDO Tx Nd.63

dec	hex	Telegram type	dec	hex	Telegram type	dec	hex	Telegram type
1537	0x601	SDO Rx Nd.1	1558	0x616	SDO Rx Nd.22	1579	0x62B	SDO Rx Nd.43
1538	0x602	SDO Rx Nd.2	1559	0x617	SDO Rx Nd.23	1580	0x62C	SDO Rx Nd.44
1539	0x603	SDO Rx Nd.3	1560	0x618	SDO Rx Nd.24	1581	0x62D	SDO Rx Nd.45
1540	0x604	SDO Rx Nd.4	1561	0x619	SDO Rx Nd.25	1582	0x62E	SDO Rx Nd.46
1541	0x605	SDO Rx Nd.5	1562	0x61A	SDO Rx Nd.26	1583	0x62F	SDO Rx Nd.47
1542	0x606	SDO Rx Nd.6	1563	0x61B	SDO Rx Nd.27	1584	0x630	SDO Rx Nd.48
1543	0x607	SDO Rx Nd.7	1564	0x61C	SDO Rx Nd.28	1585	0x631	SDO Rx Nd.49
1544	0x608	SDO Rx Nd.8	1565	0x61D	SDO Rx Nd.29	1586	0x632	SDO Rx Nd.50
1545	0x609	SDO Rx Nd.9	1566	0x61E	SDO Rx Nd.30	1587	0x633	SDO Rx Nd.51
1546	0x60A	SDO Rx Nd.10	1567	0x61F	SDO Rx Nd.31	1588	0x634	SDO Rx Nd.52
1547	0x60B	SDO Rx Nd.11	1568	0x620	SDO Rx Nd.32	1589	0x635	SDO Rx Nd.53
1548	0x60C	SDO Rx Nd.12	1569	0x621	SDO Rx Nd.33	1590	0x636	SDO Rx Nd.54
1549	0x60D	SDO Rx Nd.13	1570	0x622	SDO Rx Nd.34	1591	0x637	SDO Rx Nd.55
1550	0x60E	SDO Rx Nd.14	1571	0x623	SDO Rx Nd.35	1592	0x638	SDO Rx Nd.56
1551	0x60F	SDO Rx Nd.15	1572	0x624	SDO Rx Nd.36	1593	0x639	SDO Rx Nd.57
1552	0x610	SDO Rx Nd.16	1573	0x625	SDO Rx Nd.37	1594	0x63A	SDO Rx Nd.58
1553	0x611	SDO Rx Nd.17	1574	0x626	SDO Rx Nd.38	1595	0x63B	SDO Rx Nd.59
1554	0x612	SDO Rx Nd.18	1575	0x627	SDO Rx Nd.39	1596	0x63C	SDO Rx Nd.60
1555	0x613	SDO Rx Nd.19	1576	0x628	SDO Rx Nd.40	1597	0x63D	SDO Rx Nd.61
1556	0x614	SDO Rx Nd.20	1577	0x629	SDO Rx Nd.41	1598	0x63E	SDO Rx Nd.62
1557	0x615	SDO Rx Nd.21	1578	0x62A	SDO Rx Nd.42	1599	0x63F	SDO Rx Nd.63

dec	hex	Telegram type	dec	hex	Telegram type	dec	hex	Telegram type
1793	0x701	Guarding Nd.1	1814	0x716	Guarding Nd.22	1835	0x72B	Guarding Nd.43
1794	0x702	Guarding Nd.2	1815	0x717	Guarding Nd.23	1836	0x72C	Guarding Nd.44
1795	0x703	Guarding Nd.3	1816	0x718	Guarding Nd.24	1837	0x72D	Guarding Nd.45
1796	0x704	Guarding Nd.4	1817	0x719	Guarding Nd.25	1838	0x72E	Guarding Nd.46
1797	0x705	Guarding Nd.5	1818	0x71A	Guarding Nd.26	1839	0x72F	Guarding Nd.47
1798	0x706	Guarding Nd.6	1819	0x71B	Guarding Nd.27	1840	0x730	Guarding Nd.48
1799	0x707	Guarding Nd.7	1820	0x71C	Guarding Nd.28	1841	0x731	Guarding Nd.49
1800	0x708	Guarding Nd.8	1821	0x71D	Guarding Nd.29	1842	0x732	Guarding Nd.50
1801	0x709	Guarding Nd.9	1822	0x71E	Guarding Nd.30	1843	0x733	Guarding Nd.51
1802	0x70A	Guarding Nd.10	1823	0x71F	Guarding Nd.31	1844	0x734	Guarding Nd.52
1803	0x70B	Guarding Nd.11	1824	0x720	Guarding Nd.32	1845	0x735	Guarding Nd.53
1804	0x70C	Guarding Nd.12	1825	0x721	Guarding Nd.33	1846	0x736	Guarding Nd.54
1805	0x70D	Guarding Nd.13	1826	0x722	Guarding Nd.34	1847	0x737	Guarding Nd.55
1806	0x70E	Guarding Nd.14	1827	0x723	Guarding Nd.35	1848	0x738	Guarding Nd.56
1807	0x70F	Guarding Nd.15	1828	0x724	Guarding Nd.36	1849	0x739	Guarding Nd.57
1808	0x710	Guarding Nd.16	1829	0x725	Guarding Nd.37	1850	0x73A	Guarding Nd.58
1809	0x711	Guarding Nd.17	1830	0x726	Guarding Nd.38	1851	0x73B	Guarding Nd.59
1810	0x712	Guarding Nd.18	1831	0x727	Guarding Nd.39	1852	0x73C	Guarding Nd.60
1811	0x713	Guarding Nd.19	1832	0x728	Guarding Nd.40	1853	0x73D	Guarding Nd.61
1812	0x714	Guarding Nd.20	1833	0x729	Guarding Nd.41	1854	0x73E	Guarding Nd.62
1813	0x715	Guarding Nd.21	1834	0x72A	Guarding Nd.42	1855	0x73F	Guarding Nd.63

8.3 Firmware Update

Firmware update program

The firmware update program is required for loading a new firmware to the Bus Coupler. The program is transferred via the serial interface.

Note for BX3100:

Updates are not available with BX3100 firmware 0.64 (or lower). If these devices need updating, send the BX3100 to the manufacturer with a corresponding note.

Beckhoff Automation GmbH & Co. KG
Service Department
Stahlstr. 31
33415 Verl, Germany

 Firmware update program 241 (<https://infosys.beckhoff.com/content/1033/bx5100/Resources/zip/3238791819.zip>) 71 kbytes (for Windows NT4.0 SP6, 2000, XP).

The program *FirmwareUpdate.exe* and the file *TcRouterHelper.dll* have to be in the same directory. Open the program by double-clicking on *FirmwareUpdate.exe*.

Update for Bus Terminal Controllers

BX series

Select the appropriate device of - in this example "Serial interface (BX)".

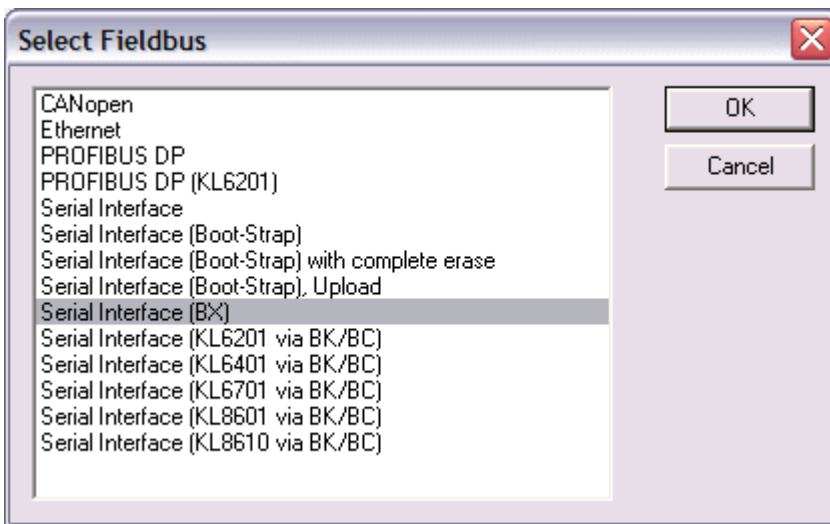

Fig. 145: Selecting a BX series Bus Terminal Controller

BCxx50 series

Select the corresponding device, in this case "Serial Interface".

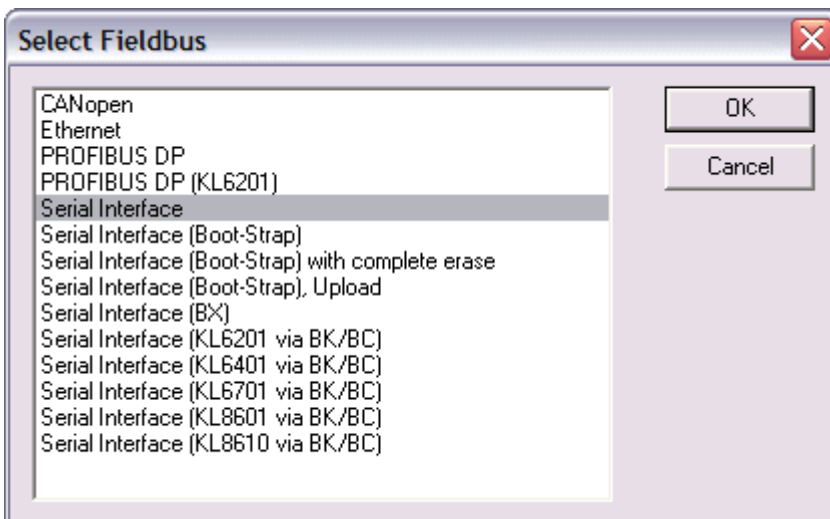

Fig. 146: Selecting a BC series Bus Terminal Controller

BX and BCxx50 series

Then select the COM port.

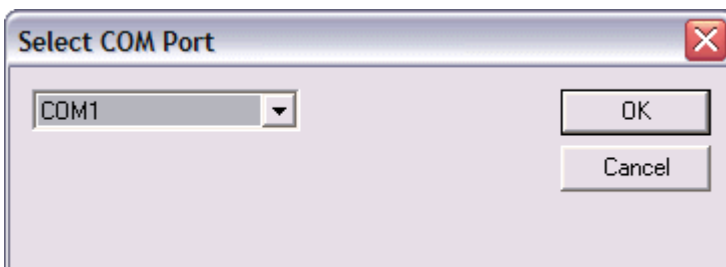

Fig. 147: Select the COM port

Open the file you wish to download.

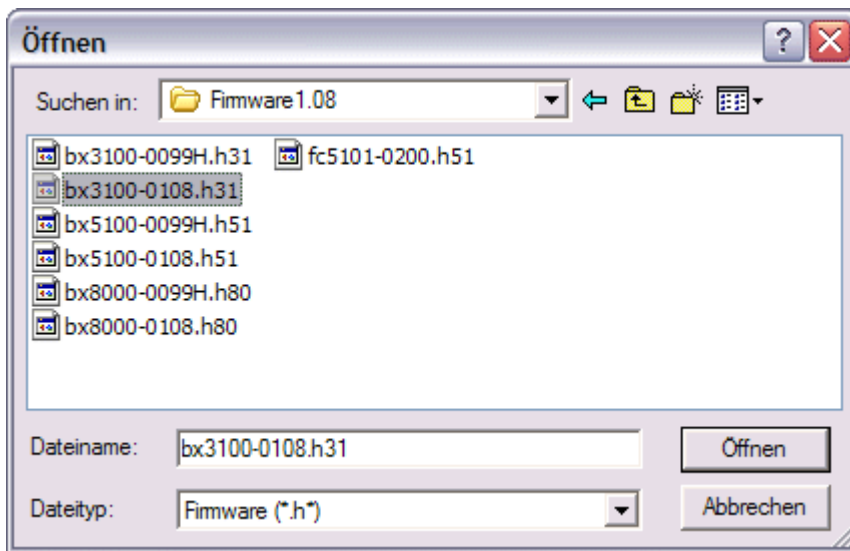

Fig. 148: Open the firmware file

Start the download via the green 'traffic light'. The download begins after about a minute, and is then also shown on the BX's display. After successful download (approx. 2 to 3 minutes) the Bus Terminal Controller reboots automatically.

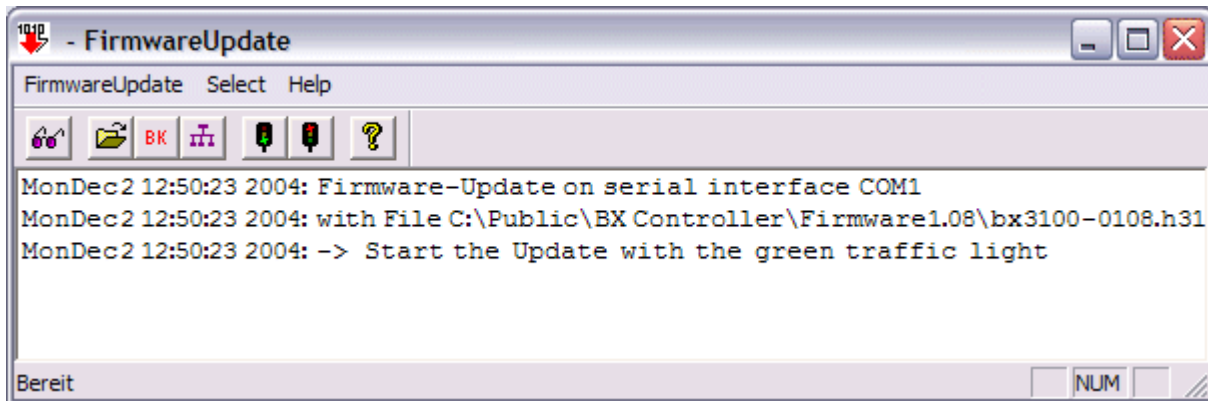



Fig. 149: Status messages relating to the firmware update

8.4 CFC-Client*

With the CFC client, the BX device offers the option of copying the complete memory content of a BX Controller. The data from the memory are saved in a BIN file and can be loaded into an identical controller.

The CFC client runs on Windows 9x, NT, 2000 and XP and is completely independent of TwinCAT.

 CFC client (<https://infosys.beckhoff.com/content/1033/bx5100/Resources/zip/3238793995.zip>) (Note: The DLLs have to be registered manually via regsvr32)

When the CFC client is started, the COM parameters have to be set first.

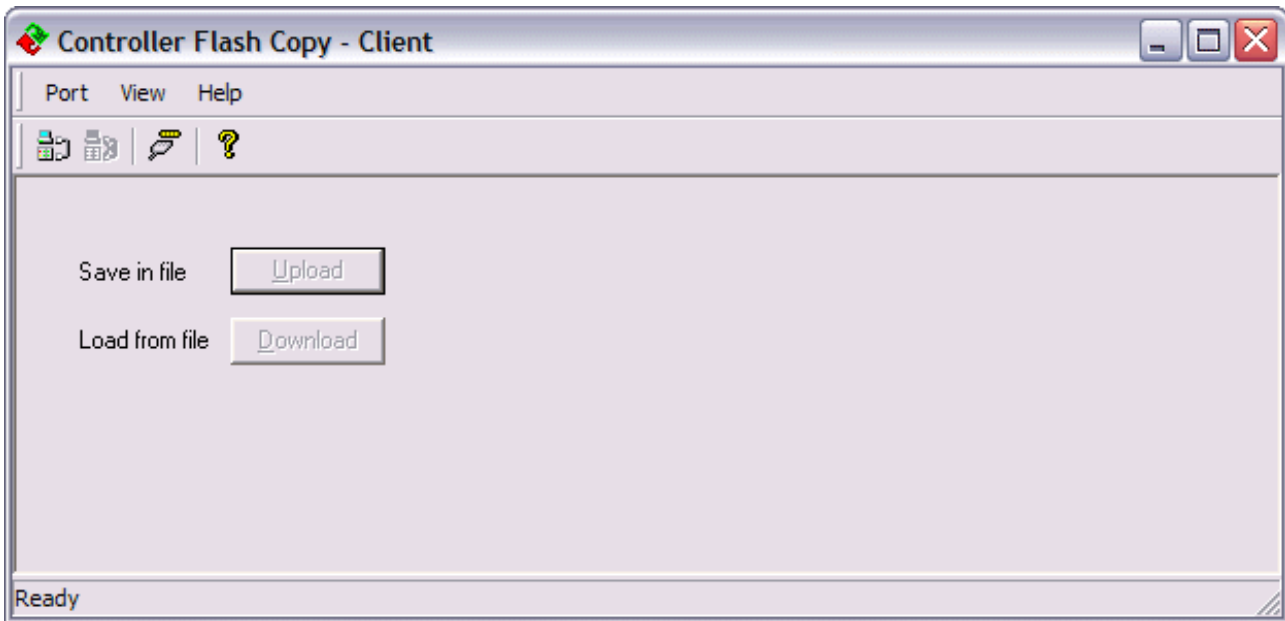

Fig. 150: CFC client

Port/Port Setup...

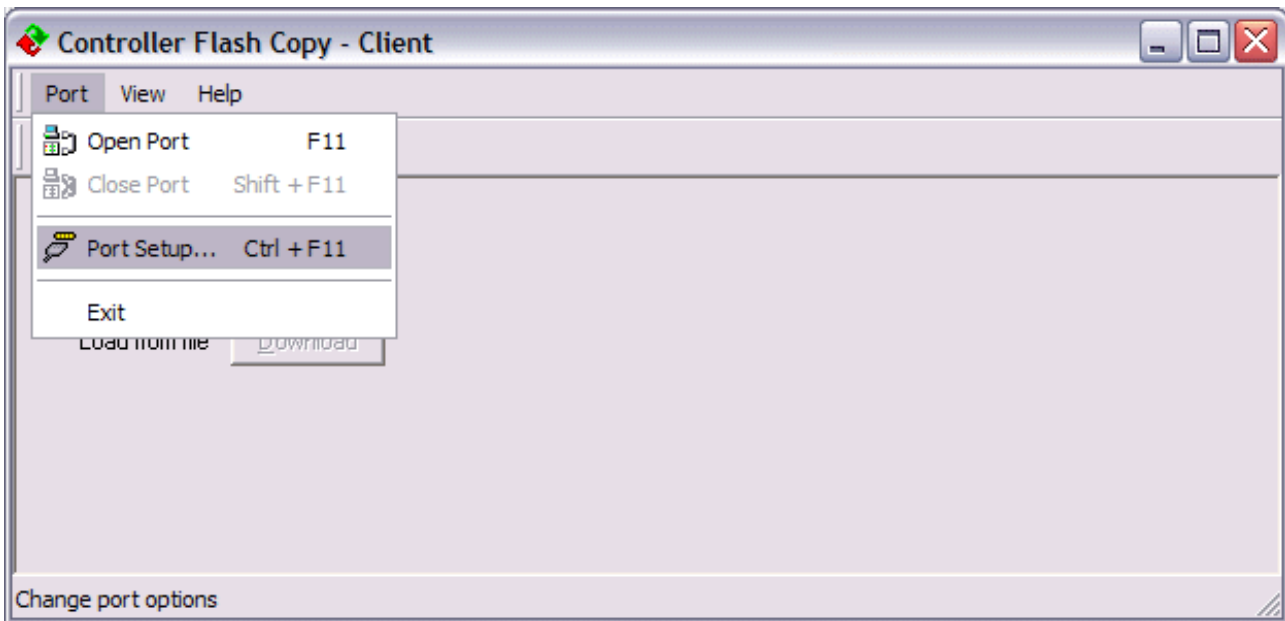

Fig. 151: Call the port setup

Select the required setting.

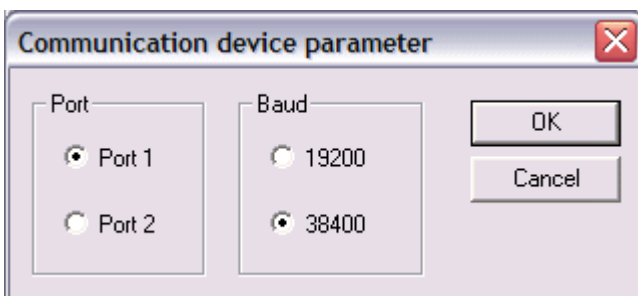

Fig. 152: Set the COM parameters

Before opening the COM port, a physical connection to the BX Controller has to be established. Then open the COM port.

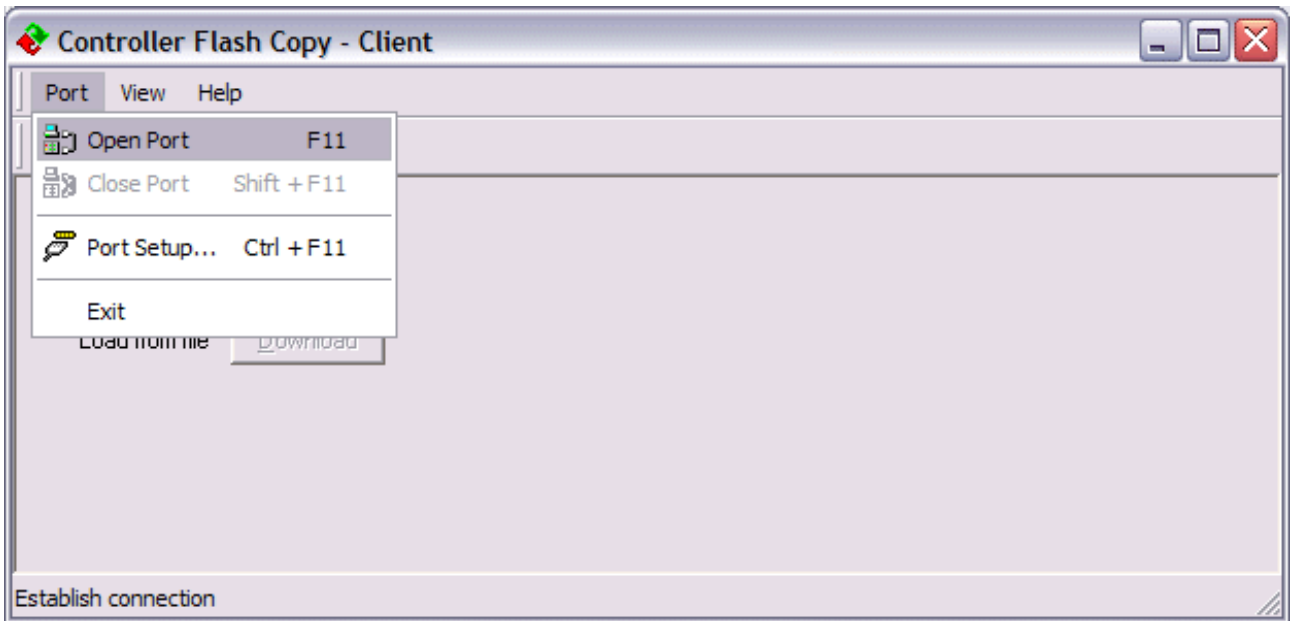

Fig. 153: Open the COM port

Use upload to create a copy of the BX memory and save it as a BIN file.

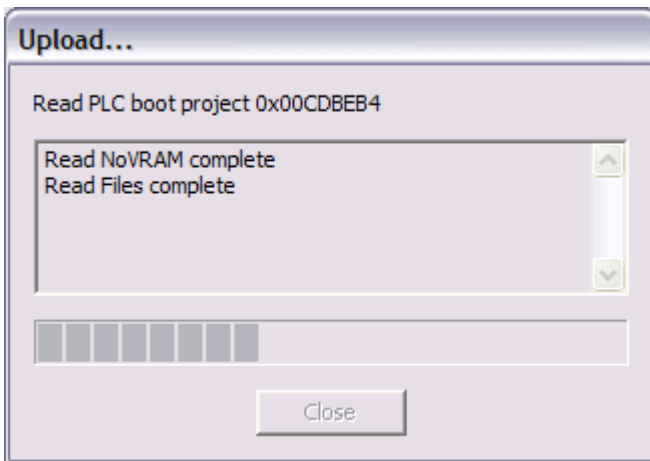

Fig. 154: Upload the BX memory content to a BIN file

Use download to load the BIN file onto the BX controller. The controller starts automatically after a successful download.

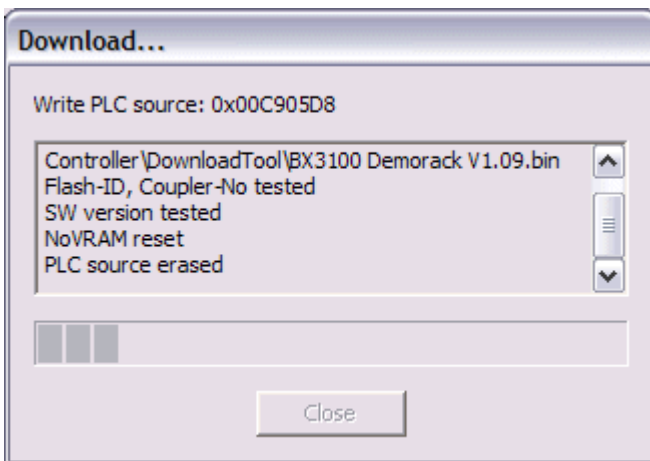

Fig. 155: Downloading a BIN file to the BX controller

* The CFC server is available on the BX Controller range from firmware version 1.09.

8.5 Sample programs - overview

Denomination	Description
Display [▶ 108]	Example for controlling the display
Navigation switch [▶ 107]	Reading of the navigation switch from the PLC
Menu [▶ 80]	Example for own menu with navigation switch and display
RTC [▶ 74]	Example for reading the real-time clock (RTC) via function blocks
COM port - BK/BC8x00 master interface [▶ 113]	COM1 or COM2 interface as master with the BK8x00 protocol
COM port - BK8x00 slave interface [▶ 114]	COM1 or COM2 interface as slave with the BK8x00 protocol
COM port - Cimrex 12 [▶ 120]	Example for controlling a Cimrex 12 display via ModbusRTU
COM port - ModbusRTU slave [▶ 117]	Link of ModbusRTU Lib with the COM 1 or COM 2 interface of the BX
COM port - ModbusRTU master [▶ 118]	Link of ModbusRTU Lib with the COM 1 or COM 2 interface of the BX
COM port - RK512 protocol [▶ 121]	RK512 protocol via COM 1 or COM 2
COM port - text message via COM port [▶ 122]	Connecting a Siemens S35 mobile phone to the COM interface for sending text messages
COM port - COMlibV2 [▶ 119]	Sending and receiving strings with COMlibV2
SSB - Display [▶ 64]	Cimrex panel at SSB
SSB - AX2000 [▶ 62]	AX2000 at SSB
SSB - BK51x0 [▶ 60]	BK5120 at SSB
SSB - BX / BX communication [▶ 61]	Communication between BXs (via SSB)
SSB - IclA Drive [▶ 65]	IclA drive at SSB
SSB - Lenze Drive [▶ 71]	Lenze frequency converter at SSB

8.6 General operating conditions

The following conditions must be met in order to ensure flawless operation of the fieldbus components.

Environmental conditions

Operation

The components may not be used without additional protection in the following locations:

- in difficult environments, such as where there are corrosive vapors or gases, or high dust levels
- in the presence of high levels of ionizing radiation

Condition	Permissible range
Permissible ambient temperature during operation	See technical data
Permissible ambient temperature during operation	-25°C ... +85 °C
Installation position	variable
Vibration resistance	conforms to EN 60068-2-6
Shock resistance	conforms to EN 60068-2-27, EN 60068-2-29
EMC immunity	conforms to EN 61000-6-2
Emission	conforms to EN 61000-6-4

Transport and storage

Condition	Permissible range
Permissible ambient temperature during storage	-25°C... +85 °C
Relative humidity	95 %, no condensation
Free fall	up to 1 m in the original packaging

Protection classes and types

Condition	Permissible range
Protection class in accordance with IEC 536 (VDE 0106, Part 1)	A protective conductor connection to the profile rail is necessary!
Protection class conforms to IEC 529	IP20 (protection against contact with a standard test finger)
Protection against foreign objects	Less than 12 mm in diameter
Protection against water	no protection

Component identification

Every supplied component includes an adhesive label providing information about the product's approvals.



Fig. 156: Name plate of a BX controller

The following information is printed on the label:

Printed item	Meaning for this label
Precise product identification	BX model
Supply voltage U_s	24 V _{DC} (Use a 4 A fuse or a Class 2 power supply to meet UL requirements!)
Manufacturer	Beckhoff Automation GmbH
CE mark	Conformity mark
UL mark 	Mark for UL approval. UL stands for the Underwriters Laboratories Inc., the leading certification organization for North America, based in the USA. C = Canada, US = USA, UL file number: E172151
Production identification	Serial No.: Serial number HW: hardware version Date: Date of manufacture optional for BX9000 MAC-ID only

8.7 Approvals

Conformity mark

CE

Protection class

IP20 conforms to EN60529

8.8 Test standards for device testing

EMC**EMC immunity**

EN 61000-6-2

Electromagnetic emission

EN 61000-6-4

Vibration / shock resistance**Vibration resistance**

EN 60068-2-6

Shock resistance

EN 60068-2-27

8.9 Bibliography

German books

- Holger Zeltwanger (ed.):
CANopen,
VDE Verlag, 2001, 197 pages,
ISBN 3-800-72448-0

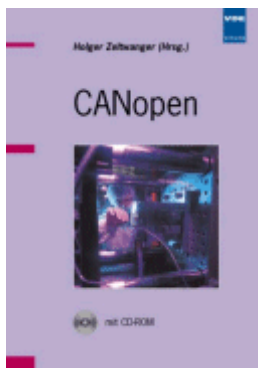

Fig. 157: CANopen

- Konrad Etschberger:
Controller Area Network, Grundlagen, Protokolle, Bausteine, Anwendungen (**Controller Area Network**, principles, protocols, devices, applications), in German.
Hanser Verlag, 2000. 431 pages.
ISBN 3-446-19431-2

General fieldbus technology

- Gerhard Gruhler (ed.):
Feldbusse und Geräte-Kommunikationssysteme, Praktisches Know-How mit
Vergleichsmöglichkeiten, (**Fieldbuses and device communication systems**, practical knowledge,

with comparison options), in German.
Franzis Verlag 2001. 244 pages.
ISBN 3-7723-5745-8

English books

- Konrad Etschberger:
Controller Area Network,
Ixxat Press, 2001. 440 pages.
ISBN 3-00-007376-0
- M. Farsi, M. Barbosa:
CANopen Implementation,
RSP 2000. 210 pages.
ISBN 0-86380-247-8

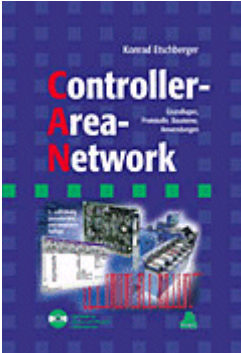

Fig. 158: CAN - Controller Area Network

Standards

- ISO 11898:
Road Vehicles - Interchange of digital information - Controller Area Network (CAN) for high speed communication.
- CiA DS 301:
CANopen Application Layer and Communication Profile.
Available from the [CAN in Automation](#) Association.
- CiA DS 401:
CANopen Device Profile for Generic E/A Modules.
Available from the [CAN in Automation](#) Association.

8.10 List of Abbreviations

CAN

Controller Area Network. Serial bus system standardized in ISO 11898 that is used as the basic technology for CANopen

CiA

CAN in Automation e.V.. An international association of manufacturers and users based in Erlangen, Germany.

COB

Communication Object. A CAN telegram with up to 8 data bytes.

COB-ID

Communication Object Identifier. Telegram address (not to be confused with the node address). CANopen uses the 11-bit identifier according to CAN 2.0A.

NMT

Network Management. One of the service primitives of the CANopen specification. Network management is used to initialize the network and to monitor nodes.

PDO

Process Data Object. A CAN telegram for the transfer of process data (e.g. I/O data).

RxPDO

Receive PDO. PDOs are always identified from the point of view of the device under consideration. Thus a TxPDO with input data from an I/O module becomes an RxPDO from the controller's point of view.

SDO

Service Data Object. A CAN telegram with a protocol for communication with data in the object directory (typically parameter data).

TxPDO

Transmit PDO (named from the point of view of the CAN node).

8.11 Support and Service

Beckhoff and their partners around the world offer comprehensive support and service, making available fast and competent assistance with all questions related to Beckhoff products and system solutions.

Beckhoff's branch offices and representatives

Please contact your Beckhoff branch office or representative for local support and service on Beckhoff products!

The addresses of Beckhoff's branch offices and representatives round the world can be found on her internet pages:

<http://www.beckhoff.com>

You will also find further documentation for Beckhoff components there.

Beckhoff Headquarters

Beckhoff Automation GmbH & Co. KG

Huelshorstweg 20
33415 Verl
Germany

Phone:	+49(0)5246/963-0
Fax:	+49(0)5246/963-198
e-mail:	info@beckhoff.com

Beckhoff Support

Support offers you comprehensive technical assistance, helping you not only with the application of individual Beckhoff products, but also with other, wide-ranging services:

- support
- design, programming and commissioning of complex automation systems
- and extensive training program for Beckhoff system components

Hotline:	+49(0)5246/963-157
Fax:	+49(0)5246/963-9157
e-mail:	support@beckhoff.com

Beckhoff Service

The Beckhoff Service Center supports you in all matters of after-sales service:

- on-site service
- repair service
- spare parts service
- hotline service

Hotline:	+49(0)5246/963-460
Fax:	+49(0)5246/963-479
e-mail:	service@beckhoff.com

List of illustrations

Fig. 1	Bus Terminal Controllers of the BX series	11
Fig. 2	BX5100	14
Fig. 3	BX3100, BX5100, BX5200, BX9000	18
Fig. 4	BX8000	19
Fig. 5	Released BX controller	19
Fig. 6	Latched BX controller	20
Fig. 7	Disassembly	20
Fig. 8	Potential groups of a Bus Terminal block	21
Fig. 9	Power contact on the left	22
Fig. 10	Terminal points for the Bus Terminal Controller supply	23
Fig. 11	UL identification	23
Fig. 12	Programming cable ZK1000-0030 - COM 1 and COM 2	24
Fig. 13	Programming cable ZK1000-0030 - plug connector dimensions	25
Fig. 14	Programming cable ZK1000-0030 - Pinning	25
Fig. 15	SSB interface	26
Fig. 16	COM1 (RS 232) and COM2 (RS 232/485) interface	26
Fig. 17	Termination of the bus with a 120 Ohm termination resistor	27
Fig. 18	Insensitivity to incoming interference	27
Fig. 19	Sample topology of drop lines	28
Fig. 20	Structure of CAN cable ZB5100	29
Fig. 21	Structure of CAN/DeviceNet cable ZB5200	29
Fig. 22	BK5151, EL6751 pin assignment	31
Fig. 23	FC51x2	31
Fig. 24	BK51x0/BX5100 socket assignment	32
Fig. 25	LC5100	33
Fig. 26	Pin assignment: M12 plug, fieldbus box	33
Fig. 27	Start-up behavior of the Bus Terminal Controller	34
Fig. 28	Creating a TwinCAT configuration	36
Fig. 29	Selecting the Bus Terminal Controller	37
Fig. 30	Downloading a TwinCAT configuration	38
Fig. 31	Selecting the Bus Terminal Controller	38
Fig. 32	State of the Bus Terminal Controller	38
Fig. 33	Activating the TwinCAT configuration	38
Fig. 34	Choose Target System	39
Fig. 35	Selecting the Bus Terminal Controller	40
Fig. 36	State of the Bus Terminal Controller	40
Fig. 37	Uploading the TwinCAT configuration	40
Fig. 38	Memory for code mapping	41
Fig. 39	Data memory mapping	41
Fig. 40	Code and data memory	42
Fig. 41	Other memory	42
Fig. 42	Properties of the remote connection	43
Fig. 43	Send delay time (inhibit time)	46
Fig. 44	Event timer	46

Fig. 45	Setting the node ID	47
Fig. 46	BX Settings tab	48
Fig. 47	BX Diag tab.....	49
Fig. 48	Selecting the PLC project	50
Fig. 49	Connecting PLC variable and hardware	51
Fig. 50	Target system display	51
Fig. 51	Setting the task time	52
Fig. 52	Displaying the PLC cycle time	53
Fig. 53	Adding a further device.....	54
Fig. 54	Selecting the CANopen master SSB	54
Fig. 55	Adding a CANopen device.....	55
Fig. 56	Selecting a CANopen node	55
Fig. 57	Adding/editing object directory entries.....	56
Fig. 58	NodeState, DiagFlag and EmergencyCounter	57
Fig. 59	Communication between BX controllers (via SSB).....	61
Fig. 60	AX2000	62
Fig. 61	CANopen Interface (X6)	64
Fig. 62	Cimrex panel at the SSB of the BX controller	64
Fig. 63	IclA drive at SSB.....	65
Fig. 64	IclA drive connections.....	66
Fig. 65	Signal interface	67
Fig. 66	Fieldbus connection.....	67
Fig. 67	Reference ranges	69
Fig. 68	Listing of the referencing values	70
Fig. 69	Frequency converter from Lenze.....	71
Fig. 70	External power supply - internal power supply(State at Delivery)	72
Fig. 71	DIP switch.....	72
Fig. 72	Enabling the communication module.....	73
Fig. 73	Setting the real-time clock (RTC).....	74
Fig. 74	Navigation switches of the BX controller	76
Fig. 75	Switch assignment.....	76
Fig. 76	Maximum number of POU's exceeded.....	82
Fig. 77	Menu path Projects / Options / Controller Settings.....	82
Fig. 78	Controller settings.....	83
Fig. 79	Global memory insufficient	83
Fig. 80	Menu path Projects / Options / Build	83
Fig. 81	Build.....	84
Fig. 82	Changing variable links.....	90
Fig. 83	Linking a variable with an input.....	90
Fig. 84	Opening the options menu.....	92
Fig. 85	Selecting Source Download.....	92
Fig. 86	Downloading the program code.....	93
Fig. 87	Download progress	93
Fig. 88	Uploading a program	94
Fig. 89	Selecting the data transfer route.....	94
Fig. 90	Selecting the device.....	94

Fig. 91	Function block F_COMPORTRREAD	102
Fig. 92	Function block F_COMPORTRWRITE	102
Fig. 93	Function block FB_COMPORTROPEN	103
Fig. 94	Function block FB_COMPORTRCLOSE	104
Fig. 95	Function block F_STARTDEBUGTRTIMER.....	107
Fig. 96	Function block F_READDEBUGTRTIMER	107
Fig. 97	Function block F_GETNAVTRSWTRCH	107
Fig. 98	Function block FB_DISPTRWRITE	108
Fig. 99	Function block RTC	110
Fig. 100	Function block fb_ReadWriteFile.....	111
Fig. 101	Function block FB_BX_BK8X00_master.....	113
Fig. 102	Function block FB_BX_BK8X00_SLAVE	114
Fig. 103	Communication features.....	116
Fig. 104	Function block FB_BX_COM_5.....	116
Fig. 105	Function block FB_BX_COM_64.....	117
Fig. 106	Function block FB_BX_COM_64EX.....	118
Fig. 107	Cimrex panel at the COM port of the BX controller	120
Fig. 108	Mobile phone at the COM port of the BX controller.....	122
Fig. 109	Function block F_GETTRVERSIONTRCTWRINSATRFE	123
Fig. 110	Function block FB_TRWRINSATRFE_KLX904_INPUT.....	123
Fig. 111	Function block FB_TRWRINSATRFE_KLX904_input.....	124
Fig. 112	Linking the input data.....	125
Fig. 113	Selecting the SafetyIn variable	125
Fig. 114	Function block FB_TRWRINSATRFE_KLX904_output.....	126
Fig. 115	Call of function block FB_TRWRINSATRFE_KLX904_OUTPUT	127
Fig. 116	Call of function block FB_TRWRINSATRFE_KLX904_OUTPUT	127
Fig. 117	Linking the input data.....	128
Fig. 118	Selecting the corresponding SafetyQBx variable	128
Fig. 119	Selecting the data transfer route - serial interface	129
Fig. 120	Parameterization of the serial interface	129
Fig. 121	Selecting the data transfer route - AMS.....	130
Fig. 122	Selecting the device.....	130
Fig. 123	Display of the BX5100 in the TwinCAT System Manager	131
Fig. 124	Choose Target System.....	132
Fig. 125	Selecting the target system - box 2, runtime 1 of the Bus Terminal Controller.....	132
Fig. 126	CANopenLogo	133
Fig. 127	CANopen Device Model	133
Fig. 128	CANopen bootup state diagram	135
Fig. 129	Schematic diagram: "Guarding procedure"	137
Fig. 130	Schematic diagram: "Heartbeat procedure"	138
Fig. 131	Default identifier allocation: Master/Slave.....	140
Fig. 132	PDO linking: Peer to Peer.....	140
Fig. 133	Diagram: CAN process data transmission.....	141
Fig. 134	Diagram: CAN "SYNC" telegram	142
Fig. 135	Timing diagram: "Inhibit time"	143
Fig. 136	Time representation of the event timer	144

Fig. 137 Mapping representation	145
Fig. 138 SDO protocol: access to the object directory.....	148
Fig. 139 Default Identifier.....	151
Fig. 140 Example for data assignment	177
Fig. 141 CANopen diagnostic byte in the System Manager	181
Fig. 142 State of the K-bus	182
Fig. 143 Diagnostic LEDs for the fieldbus, the PLC, the K-bus and the power supply units	182
Fig. 144 Diagnostic LEDs for the fieldbus, the PLC and the K-bus	183
Fig. 145 Selecting a BX series Bus Terminal Controller.....	206
Fig. 146 Selecting a BC series Bus Terminal Controller.....	206
Fig. 147 Select the COM port	206
Fig. 148 Open the firmware file.....	207
Fig. 149 Status messages relating to the firmware update.....	207
Fig. 150 CFC client.....	208
Fig. 151 Call the port setup.....	208
Fig. 152 Set the COM parameters.....	208
Fig. 153 Open the COM port	209
Fig. 154 Upload the BX memory content to a BIN file	209
Fig. 155 Downloading a BIN file to the BX controller.....	209
Fig. 156 Name plate of a BX controller.....	211
Fig. 157 CANopen	212
Fig. 158 CAN - Controller Area Network	213