

Installation and operating instructions

CPX29xx-0000

Multi-touch Control Panel with DVI/USB Extended interface for use in hazardous locations, zone 2/22

Version: 0.1
Date: 2017-09-15

BECKHOFF

Table of Contents

1	Notes on the documentation	5
1.1	Explanation of symbols	6
1.2	Documentation issue status	7
2	For your safety	8
2.1	Intended use	8
2.2	Notes about operation in potentially explosive areas	9
2.2.1	Special conditions (ATEX)	9
2.2.2	Special conditions (IECEX)	9
2.2.3	Marking	10
2.3	Safety instructions	11
2.4	Staff qualification	12
2.5	Operator's responsibility	12
3	Transport and storage	13
4	Product overview	14
4.1	Access to the interfaces	15
4.2	Name plate	16
4.3	Description of the interfaces	17
4.3.1	Power supply (X101)	17
4.3.2	USB out (X102, X103)	17
4.3.3	USB In (X104)	18
4.3.4	USB-E In (X105)	18
4.3.5	DVI-D In (X106)	18
4.3.6	Ground	19
5	Mounting and wiring	20
5.1	Mounting	20
5.1.1	Preparation of the control cabinet	20
5.1.2	Mounting of the Control Panel	22
5.2	Wiring	23
5.2.1	Preperation and protective earthing	23
5.2.2	Fitting the power supply cable	24
5.2.3	Using the mounting bracket	25
6	Operation	26
6.1	Switching the Control Panel on and off	26
6.2	Touch screen	26
6.3	Servicing and maintenance	27
6.4	Emergency procedures	27
6.5	Shutting down	27
7	Troubleshooting	28
8	Assembly dimensions	29
9	Technical Data	32
10	Appendix	33
10.1	Standards reference for explosive atmospheres	33
10.2	Connection Kits/ Connection Cables/Accessories	34
10.3	Approvals for USA and Canada	35

10.4 Support and Service 36

1 Notes on the documentation

This description is only intended for the use of trained specialists in control and automation engineering who are familiar with the applicable national standards.

It is essential that the documentation and the following notes and explanations are followed when installing and commissioning the components.

It is the duty of the technical personnel to use the documentation published at the respective time of each installation and commissioning.

The responsible staff must ensure that the application or use of the products described satisfy all the requirements for safety, including all the relevant laws, regulations, guidelines and standards.

Disclaimer

The documentation has been prepared with care. The products described are, however, constantly under development.

We reserve the right to revise and change the documentation at any time and without prior announcement.

No claims for the modification of products that have already been supplied may be made on the basis of the data, diagrams and descriptions in this documentation.

Trademarks

Beckhoff®, TwinCAT®, EtherCAT®, Safety over EtherCAT®, TwinSAFE®, XFC® and XTS® are registered trademarks of and licensed by Beckhoff Automation GmbH.

Other designations used in this publication may be trademarks whose use by third parties for their own purposes could violate the rights of the owners.

Patent Pending

The EtherCAT Technology is covered, including but not limited to the following patent applications and patents:

EP1590927, EP1789857, DE102004044764, DE102007017835

with corresponding applications or registrations in various other countries.

The TwinCAT Technology is covered, including but not limited to the following patent applications and patents:

EP0851348, US6167425 with corresponding applications or registrations in various other countries.



EtherCAT® is registered trademark and patented technology, licensed by Beckhoff Automation GmbH, Germany

Copyright

© Beckhoff Automation GmbH & Co. KG, Germany.



The reproduction, distribution and utilization of this document as well as the communication of its contents to others without express authorization are prohibited.

Offenders will be held liable for the payment of damages. All rights reserved in the event of the grant of a patent, utility model or design.

1.1 Explanation of symbols

The following symbols with corresponding warnings or explanatory text are used in the documentation. Read and follow the warnings.

Symbols that warn of personal injury:

 DANGER	Serious risk of injury Note this warning. Hazard with high risk of death or serious injury.
 WARNING	Risk of injury Note this warning. Hazard with medium risk of death or serious injury.
 CAUTION	Personal injuries Note this warning. Hazard with a low degree of risk, which could lead to minor or moderate injury.

Symbols that warn of damage to property or equipment:

 Attention	Damage to the devices or environment Note this warning. Risk of damage to the environment and equipment.
---	--

Symbols indicating further information or tips:

 Note	Tip or pointer This symbol indicates information that contributes to better understanding.
--	--

1.2 Documentation issue status

Version	Comment
0.1	Preliminary Version

2 For your safety

Read the chapter on safety and follow the instructions in order to protect from personal injury and damage to equipment.

Limitation of liability

All the components are supplied in particular hardware and software configurations appropriate for the application. Unauthorized modifications and changes to the hardware or software configuration, which go beyond the documented options, are prohibited and nullify the liability of Beckhoff Automation GmbH & Co. KG.

In addition, the following actions are excluded from the liability of Beckhoff Automation GmbH & Co. KG:

- Failure to comply with this documentation.
- Improper use.
- Untrained personnel.
- Use of unauthorized replacement parts.

2.1 Intended use

The built-in Control Panel CPX29xx is designed for industrial application in machine and plant engineering. The Control Panel is installed in the front of control cabinet and used to operate an Industrial PC.

The DVI/USB extension technology integrated in the CPX29xx-0000 Control Panel also enables remote Panel operation at a distance of up to 50 m from the PC via a standard cable.

The Control Panel has no sparking components and is designed for a working environment that meets the requirements of protection class IP 20 at the rear side and IP65 at the front side.

The specified limits for electrical and technical data must be adhered to.

Potentially explosive atmospheres

The Control Panel is only suitable for the following potentially explosive atmospheres:

1. For Zone 2 areas in which gas is present as a combustible material. Zone 2 means that an explosive atmosphere does usually not occur during normal operation, or only for a short time.
2. For Zone 22 areas in which dust is present as a combustible material. Zone 22 means that an explosive atmosphere in the form of a cloud does usually not occur during normal operation, or only for a short time.

The back side of the Control Panel must be installed in a suitable housing:

1. The Control Panel must be installed in a housing, which ensures protection class IP 54 for gas according to EN 60079-7 or IEC 60079-7.
2. A housing with protection class IP 54 is required for fibers and flyings, and for non-conductive dust. IP 6X is required for conductive dust according to EN 60079-31 or IEC 60079-31.

Improper use

The Control Panel is not suitable for operation in the following areas:

- The Control Panel must not be used in other zones except for 2/22 and not without a suitable housing.
- Areas with an aggressive environment, e.g. aggressive gases or chemicals.
- Living areas. In living areas, the relevant standards and guidelines for interference emissions must be adhered to, and the devices must be installed in housings or control cabinets with suitable shielding.

2.2 Notes about operation in potentially explosive areas

2.2.1 Special conditions (ATEX)

 WARNING	<p>Danger of explosion</p> <p>Gases or dusts can be ignited in potentially explosive areas. Read and follow the safety instructions to prevent deflagration or explosions.</p>
---	---

The Control Panel must be installed in a housing, which ensures protection class IP54 for gas according to EN 60079-7.

A housing with protection class IP54 is required for fibers and flyings, and for non-conductive dust. IP6X is required for conductive dust according to EN 60079-31.

Provisions shall be made to prevent the rated voltage from being exceeded by transient disturbances of more than 119 V.

If the temperatures during rated operation are higher than 70 °C at the feed-in points of cables, lines or pipes, or higher than 80°C at the wire branching points, then cables must be selected whose temperature data correspond to the actual measured temperature values.

Observe the permissible ambient temperature during operation in potentially explosive areas. The permissible ambient temperature range during operation is 0 °C to +55 °C.

The connections of the Control Panel may only be connected or disconnected if the supply voltage has been switched off or if a non-explosive atmosphere is ensured.

Fix the USB cables with cable straps to the mounting bracket. Check tensile strength of the cables regularly and retightened the cable straps if necessary.

The Control Panel may only be mounted horizontally (see: [Mounting \[▶ 20\]](#)).

2.2.2 Special conditions (IECEx)

 WARNING	<p>Danger of explosion</p> <p>Gases or dusts can be ignited in potentially explosive areas. Read and follow the safety instructions to prevent deflagration or explosions.</p>
---	---

The Control Panel must be installed in a housing, which ensures protection class IP54 for gas according to IEC 60079-7. A housing with protection class IP54 is required for fibers and flyings, and for non-conductive dust. IP6X is required for conductive dust according to IEC 60079-31.

Provisions shall be made to prevent the rated voltage from being exceeded by transient disturbances of more than 119 V.

If the temperatures during rated operation are higher than 70 °C at the feed-in points of cables, lines or pipes, or higher than 80°C at the wire branching points, then cables must be selected whose temperature data correspond to the actual measured temperature values.

Observe the permissible ambient temperature during operation in potentially explosive areas. The permissible ambient temperature range during operation is 0 °C to +55 °C.

The connections of the Control Panel may only be connected or disconnected if the supply voltage has been switched off and if a non-explosive atmosphere is ensured.

Fix the USB cables with cable straps to the mounting bracket. Check tensile strength of the cables regularly and retightened the cable straps if necessary.

The Control Panel may only be mounted horizontally (see: [Mounting \[▶ 20\]](#)).

2.2.3 Marking

The Control Panel CPX29xx-0000 bears a continuous serial number, markings and a production date on the name plate.

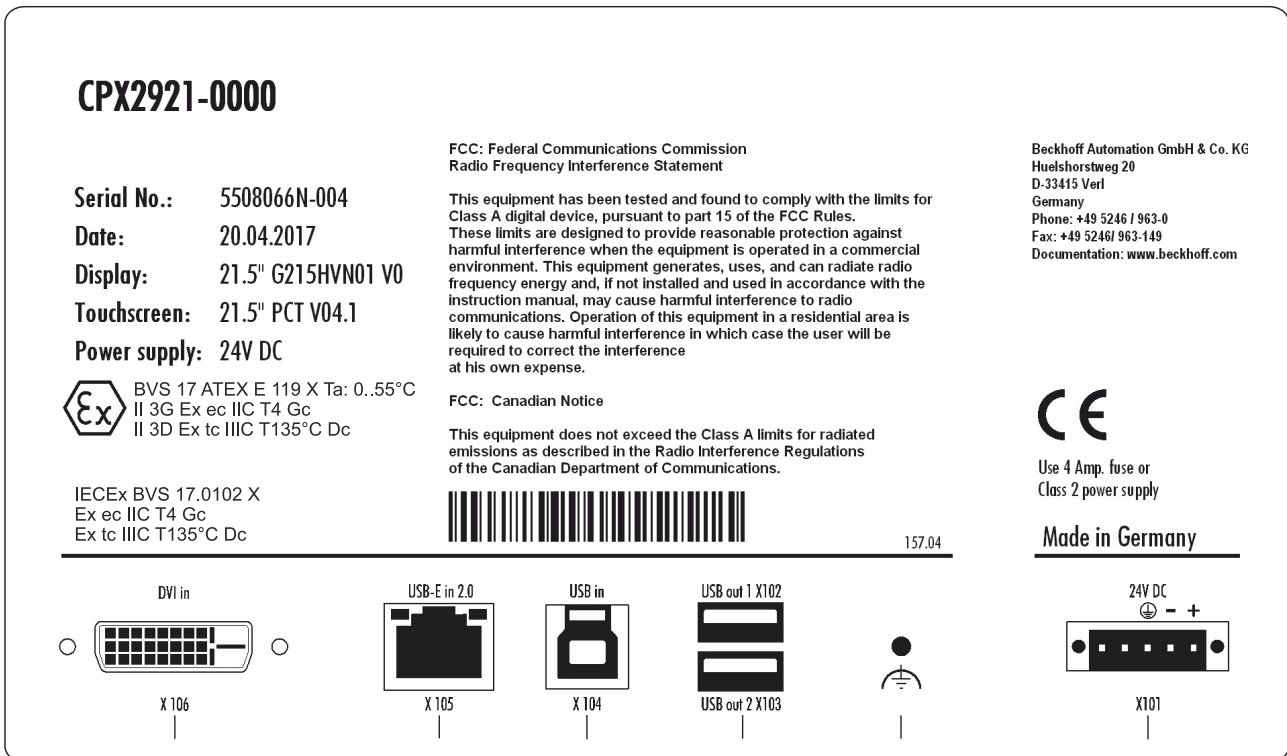

Fig. 1: Name plate on the back side of the Control Panel CPX29xx-0000.

The Control Panel CPX29xx-0000 is certified for potentially explosive areas and bears the following markings:

ATEX:

Ex BVS 17 ATEX E 119 X Ta: 0..55°C
II 3G Ex ec IIC T4 Gc
II 3D Ex tc IIIC T135°C Dc

IECEx:

IECEx BVS 17.0102 X
Ex ec IIC T4 Gc
Ex tc IIIC T135°C Dc

2.3 Safety instructions

The following safety instructions must be followed during installation and working with networks and the software.

Mounting

- Never work on live equipment. Always switch off the power supply for the device before installation, troubleshooting or maintenance. Protect the device against unintentional switching on.
- Observe the relevant accident prevention regulations for your machine (e.g. the BGV A 3, electrical systems and equipment).
- Ensure standard-compliant connection and avoid risks to personnel. Ensure that data and supply cables are laid in a standard-compliant manner and ensure correct pin assignment.
- Observe the relevant EMC guidelines for your application.
- Avoid polarity reversal of the data and supply cables, as this may cause damage to the equipment.
- The devices contain electronic components, which may be destroyed by electrostatic discharge when touched. Observe the safety precautions against electrostatic discharge according to DIN EN 61340-5-1/-3.

Working with networks

- Limit physical and electronic access to all devices to an authorized group of persons.
- Change the default passwords to reduce the risk of unauthorized access. Regularly change the passwords.
- Install the devices behind a firewall.
- Apply the IT security precautions according to IEC 62443, in order to limit access to and control of devices and networks.

Working with the software

- Use up-to-date security software. The safe function of the Industrial PC can be compromised by malicious software such as viruses or Trojans.
- The sensitivity of an Industrial PC against malicious software increases with the number of installed and active software.
- Uninstall or disable unnecessary software.

Further information about the safe handling of networks and software can be found in the Beckhoff Information System:

<http://infosys.beckhoff.com>

Document name
Documentation about IPC Security

2.4 Staff qualification

All operations involving Beckhoff software and hardware may only be carried out by qualified personnel with knowledge of control and automation engineering. The qualified personnel must have knowledge of the administration of the Control Panel and the associated network.

All interventions must be carried out with knowledge of control programming, and the qualified personnel must be familiar with the current standards and guidelines for the automation environment.

2.5 Operator's responsibility

The operator must ensure that:

- the product is only used as intended (see chapter: [Intended use \[► 8\]](#)).
- the product is in a sound condition and in working order during operation.
- the product is operated, maintained and repaired only by qualified and authorized personnel.
- the personnel is instructed regularly about relevant safety aspects, and is familiar with the operating manual and in particular the safety instructions contained herein.
- the operation manual is in good condition and complete, and always available for reference at the location of the product.

National regulations

Depending on the type of machine and plant in which the Control Panel is used, national regulations governing the controllers of such machines will apply, and must be observed by the operator. These regulations cover, amongst other things, the intervals between inspections of the controller. The operator must initiate such inspections in good time.

Procedure in the event of a fault

In the event of faults at the Control Panel, the list in the section [Troubleshooting \[► 28\]](#) can be used to determine the measures to be taken.

Operator requirements

Anyone who uses the Control Panel must have read these operating instructions and must be familiar with all the functions of the software installed on the Industrial PC to which he has access.

3 Transport and storage

Transport

 Attention	<p>Short circuit due to moisture</p> <p>Moisture can form during transport in cold weather or in the event of large temperature fluctuations.</p> <p>Avoid moisture formation (condensation) in the Control Panel, and leave it to adjust to room temperature slowly. If condensation has occurred, wait at least 12 hours before switching on the Control Panel.</p>
---	--

Despite the robust design of the unit, the components are sensitive to strong vibrations and impacts. During transport the Control Panel must be protected from:

- excessive mechanical stress
- and the original packaging should be used.

Table 1: Dimensions and weight of the individual Panels.

	CPX2915	CPX2919	CPX2921
Dimensions (W x H x D)	368.2 x 295.3 x 58 mm	438,3 x 369 x 58 mm	543 x 334.7 x 58 mm
Weight	approx. 3.7 kg	approx. 5.4 kg	approx. 5.9 kg

Storage

Store the Control Panel in the original packaging in a dry environment at a temperature between -20°C and 70°C.

Unpacking

Proceed as follows to unpack the unit:

1. Remove packaging.
2. Do not discard the original packaging. Keep it for future relocation.
3. Check the delivery for completeness by comparing it with your order.
4. Please keep the associated paperwork. It contains important information for handling the unit.
5. Check the contents for visible shipping damage.

If you notice any shipping damage or inconsistencies between the contents and your order, you should notify Beckhoff Service.

4 Product overview



Fig. 2: Front and back view of the Control Panel CPX29xx-0000.

No.	Component	Description
1	Multi-touch display.	Display with multi-touch technology. A special touch-sensitive interface for the operation and the input of data with the help of gestures.
2	Connection block. Description of the interfaces [► 17]	With all the interfaces like DVI-D, USB, USB-E and power supply.
3	Name plate [► 16]	Contains information about Serial No., production date and markings for potentially explosive areas.
4	Metal frame and rubber seal.	Resilient seal for potentially explosive areas. The metal frame is mounted on the inside of the control cabinet wall. The metal frame is used to press the Control Panel and the seal evenly against the control cabinet wall.
5	Clamping levers. Mounting [► 20]	The clamping levers are used to mount the Control Panel in a control cabinet wall.

The new Beckhoff panel generation with industry-standard multi-touch display offers a solution for any application. The control panel is also suitable for hazardous locations of Zone 2/22. The wide selection of models offers different display sizes and formats. Even for single-touch users, this new panel generation offers an excellent price- to-performance ratio and represents an economical alternative to other systems.

The multi-touch built-in Control Panel offer the following benefits:

- 3 display sizes with 15, 19 and 21.5 inch.
- multi-touch (PCT): e.g. for 5-finger or 2-hand touch operation.
- high touch-point density for safe operation.
- aluminium housing with glass front, front side IP65, rear side IP20.
- CPX29xx-0000 with integrated DVI/USB extension technology:
 - DVI-E and USB-E 2.0 enable remote panel operation at a distance of up to 50 m from the PC
 - USB-E 2.0 transmits USB 2.0 with 480 Mbit/s
 - DVI-E input is compatible to the standard DVI output of a PC
- 2-port USB socket inside the Control Panel backplane.

4.1 Access to the interfaces

The interfaces of the Control Panel are located at the rear side of the housing.



Fig. 3: Connection block of the Control Panel CPX29xx-0000 with all interfaces.

4.2 Name plate

The Control Panel CPX29xx-0000 bears a continuous serial number, markings and a production date on the name plate.

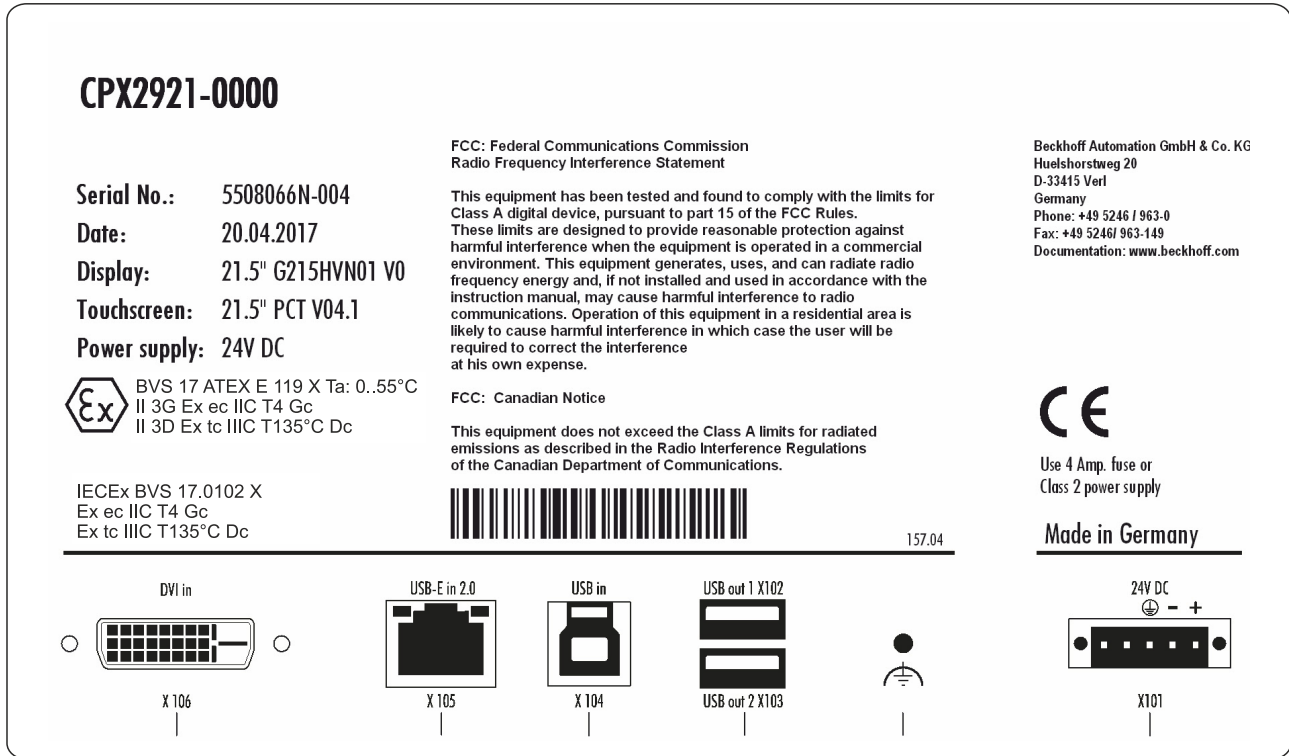

Fig. 4: Name plate on the back side of the Control Panel CPX29xx-0000.

The Control Panel CPX29xx-0000 is certified for potentially explosive areas and bears the following markings:

ATEX:

ATEX

BVS 17 ATEX E 119 X Ta: 0..55°C
 II 3G Ex ec IIC T4 Gc
 II 3D Ex tc IIIC T135°C Dc

IECEx:

IECEx

BVS 17.0102 X
 Ex ec IIC T4 Gc
 Ex tc IIIC T135°C Dc

4.3 Description of the interfaces

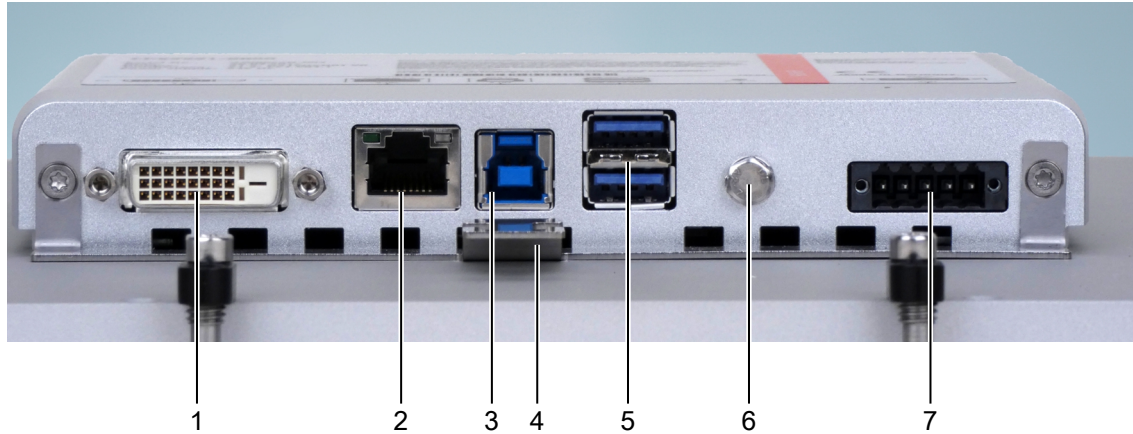

Fig. 5: Interfaces of the Control Panel CPX29xx-0000.

Nr	Interface	Nr	Interface
1	DVI-D In (X106) [▶ 18]	5	USB out (X102, X103) [▶ 17]
2	USB-E In (X105) [▶ 18]	6	Ground [▶ 19]
3	USB In (X104) [▶ 18]	7	Power supply (X101) [▶ 17]
4	Mounting bracket (see: Using the mounting bracket [▶ 25])		

4.3.1 Power supply (X101)



X101

Socket 5-pol RM3.50 Sw Screw Clamp BL3.5/180F (WEIDMÜLLER 1615810000)

The power supply for the Control Panel is established via the socket (**X101**). The power supply connector is included in delivery.

Pin	Signal	Pin	Signal
1	NC	4	GND
2	NC	5	+ 24 VDC
3	⊕		

4.3.2 USB out (X102, X103)



X102, X103

USB Type-A twin circuit board mounting (FCI 72309-0030B USB Double Receptacle A-Type)

The two USB interfaces (**X102, X103**, connector type A) are used for connecting peripheral devices with USB connection. USB3.0 standard is supported in a distance of up to 3 m from the PC, from a distance of 3 m up to 50 m or if using USB-Extended, USB2.0 standard is supported.

Pin	Signal	Pin	Signal
1	5V	3	D+
2	D-	4	GND

4.3.3 USB In (X104)



X104

USB type B, PCB installation (FCI 61729-0010B USB Receptacle B-Type)

The Control Panel is connected with the Industrial PC via the USB port (**X 104**, connector type B). USB3.0 standard is supported.

Pin	Signal	Pin	Signal
1	5V	3	D+
2	D-	4	GND

4.3.4 USB-E In (X105)



X105

Connection via standard-RJ45-cabel, not crossed

The Control Panel is connected with the CU8801 USB to USB extended converter box via the USB-Extended input (**X 105**).

In order to realize a distance of 50 m without hubs, with USB extended the USB signal is converted so that it can be transferred via 50 m CAT5 cables commonly used for Ethernet wiring. In the Control Panel the signal is converted back to USB.

4.3.5 DVI-D In (X106)



X106

DVI-D 3 X 8-pole digital PCB installation (MOLEX 74320-9000 / 74320-9004)

The DVI-D connection (**X 106**) is used for transferring the video signal from the Industrial PC to the Control Panel.

The graphics signal is transferred directly via a DVI cable over a distance of 50 m max. Such a cable length leads to strong distortion of the graphics signal on arrival at the Control Panel. The CPX29xx Control Panel features a signal processor that restores the DVI signal. The PC requires a conventional DVI output.

Pin	Signal	Pin	Signal
1	Rx2-	13	Rx3+
2	Rx2-	14	+ 5V DVI
3	GND	15	GND
4	Rx4-	16	HPD
5	Rx4+	17	Rx0-
6	DDC CLK	18	Rx0+
7	DDC DAT	19	GND
8	AV SYNC	20	Rx5-
9	Rx1-	21	Rx5+
10	Rx1+	22	GND
11	GND	23	RxC+
12	Rx3-	24	RxC-

4.3.6 Ground



Note

Malfunction possible with missing ground connection

A proper ground connection of the device is absolutely necessary for the correct function of the touchscreen.

The Control Panel is grounded via the screw connection (**Ground**).

A wire cross-section of min. 4 mm² is required.

5 Mounting and wiring

5.1 Mounting

The Control Panel CPX29xx is designed for mounting in control cabinets in machine and plant engineering applications. The ambient conditions specified for operation must be observed (see chapter: [Technical Data](#) [▶ 32]).

Permitted mounting position

The Control Panel may only be mounted horizontally.

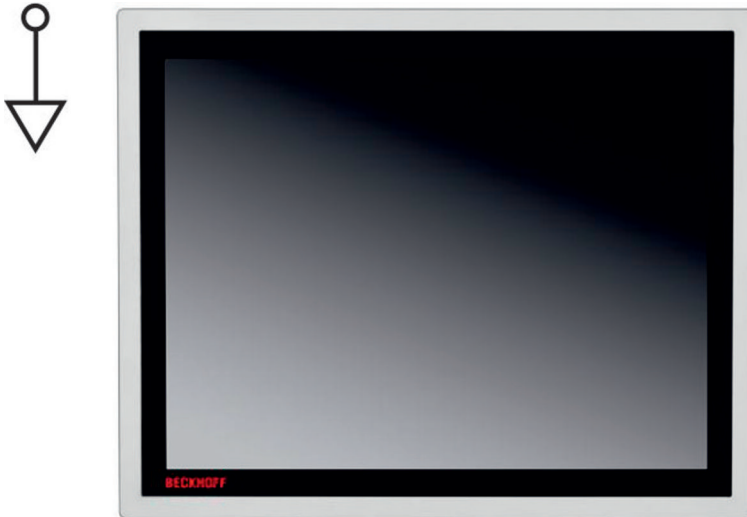

Fig. 6: Permitted mounting position.

5.1.1 Preparation of the control cabinet

The control cabinet wall must be prepared with the required mounting opening according to the Control Panel's dimensions (see chapter [Assembly dimensions](#) [▶ 29]).



Note

Circulation of air

When the unit is installed in an enclosure, adequate space for ventilation must be provided. The clearance above and below the housing must be at least 5 cm in order to ensure adequate ventilation of the Control Panel.

Please note the following points during installation of the Control Panel:

- Position the Control Panel in such a way that reflections on the screen are avoided as far as possible.
- Use the position of the screen as a guide for the correct installation height; it should be optimally visible for the user at all times.
- The Control Panel should not be exposed to direct sunlight.
- When the unit is in its mounting position, the ventilation openings must not be obstructed.



Attention

Avoid extreme environmental conditions

Extreme environmental conditions should be avoided as far as possible. Protect the Control Panel from dust, moisture and heat. The ventilation slots of the Control Panel must not be covered.

Earthing measures

Earthing connections dissipate interference from external power supply cables, signal cables or cables to peripheral equipment. Establish a low-impedance connection from the earthing point on the Control Panel housing to the central earthing point on the control cabinet wall, in which the Panel is being installed.



Note

Malfunction possible with missing ground connection

A proper ground connection of the device is absolutely necessary for the correct function of the touchscreen.

5.1.2 Mounting of the Control Panel

The Control Panel is installed in the cabinet wall with clamping levers. You need to cutout the cabinet wall for the Control Panel. For the cutout dimensions of the Control Panel see chapter: [Assembly dimensions](#) [▶ 29].

The Control Panel may only be mounted horizontally.

Requirements:

- Wall thickness of control cabinet is between 1 mm and 5 mm.
- 3.0 mm hexagon socket wrench.

Proceed as follows:

1. Release the clamping levers, turn the clamping levers to the side and take out the metal frame.

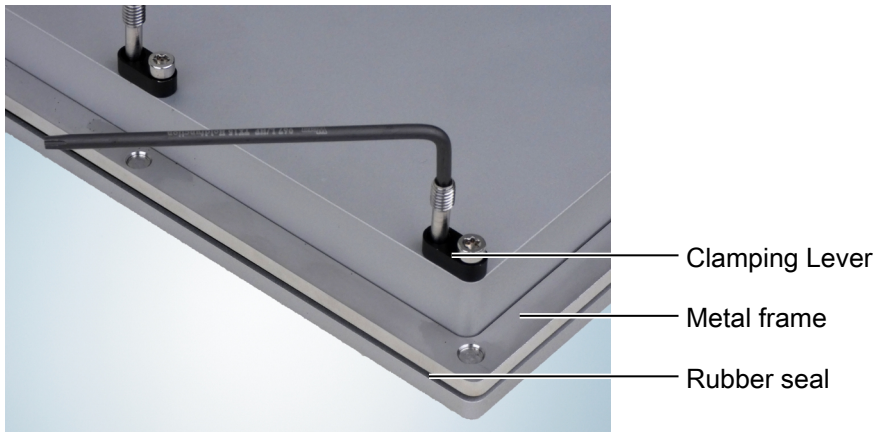

2. Insert the Control Panel into the cutout and protect it from falling out.
3. Mount the metal frame on the back side of the cabinet wall to its previous position. The metal frame is there to push the Control Panel evenly against the cabinet wall

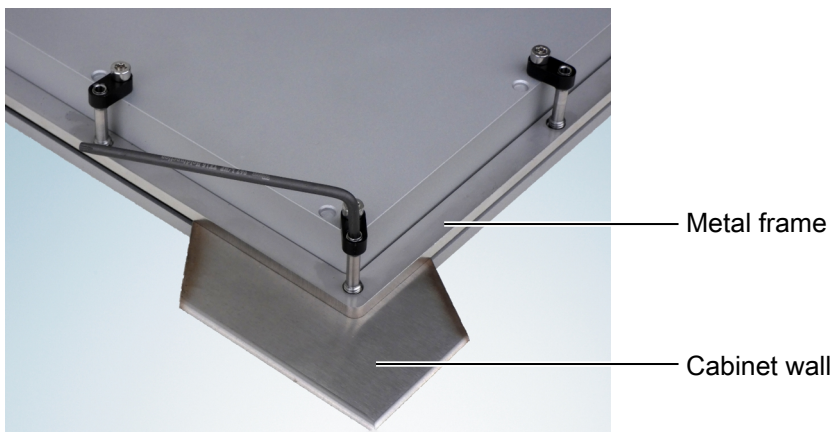

4. Turn the clamping leavers to the side through 90°.
 5. Retighten the screws. Tightening torque of the screw: 1 to 1.2 Nm.
- ⇒ Check tensile strength of the clamping leaves and if the Control Panel is mounted correctly.

5.2 Wiring

5.2.1 Preperation and protective earthing



Attention

The mains plug must be disconnected

Please read the documentation for the external devices prior to connecting them! During thunderstorms, plug connector must neither be inserted nor removed! when disconnecting a plug connector, always handle it at the plug. Do not pull the cable!

Connecting cables

The connections are located at the rear of the Control Panel and are documented in the chapter Interfaces.

When connecting cables to the Control Panel, please adhere to the following order:

- Disconnect the Control Panel from the power supply.
- Connect all cables at the Control Panel and at the devices to be connected.
- Ensure that all screw connections between connectors and sockets are tight!
- Reconnect all devices to the power supply.

Protective Earthing



Note

Malfunction possible with missing ground connection

A proper ground connection of the device is absolutely necessary for the correct function of the touchscreen.



The low resistance protective earthing connection of the Control Panel is established via the screw connection, which is located in the connection area.

A wire cross-section of min. 4 mm² is required.

5.2.2 Fitting the power supply cable



Note

Conductive cross-section

The connector is specified for 10 A and can lift conductive cross-sections until 1.5 mm².

Fit the cables for the power supply of the Control Panel, using the included material for assembling the connectors:

Material for assembling the connector



Plug connector 5-pole

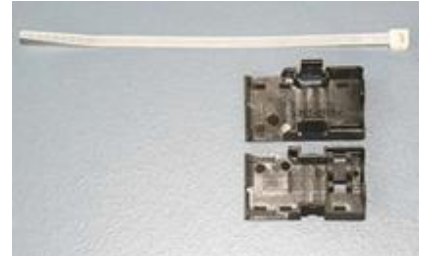

Stain relief housing with lacing cord

So the connector is fitted to the cable

1. Strip insulation from the cable ends (Length of stripped conductor is 8 - 9 mm).
2. Screw together the cable ends in the 5-pole plug connector in accordance with wiring diagram.

Applying the strain relief

Thread the lacing cord into that lower part of the stain relief housing.



Putting in the plug connector

Put the plug connector into that lower part of the stain relief housing.
Tighten the lacing cord and pinch off the plastic strap.



Fixing the upper part of the stain relief housing

Fix the upper part of the stain relief housing by snapping it onto the lower part.



5.2.3 Using the mounting bracket

In potentially explosive areas the USB plugs must not slip out of the interfaces. Fix the USB cables with cable straps to the mounting bracket.

Requirements:

- Cable straps.
- Nipper or a side cutter.

Proceed as follows:

1. Connect the USB plugs to the interfaces X102, X103 and X104.
2. When the USB plugs are placed, fix the USB cables with cable straps to the mounting bracket.



3. Cut off the remains of the cable straps with nippers or a side cutter.

⇒ Check the tensile strength of the cables regularly and retightened the cable straps if necessary.

6 Operation

6.1 Switching the Control Panel on and off

Switching on

The Control Panel does not have its own mains power switch. As soon as the power supply is switched on the Control Panel is activated.

Shutting down and switching off

Control software such as is typically used on Industrial PCs permits various users to be given different rights. A user who may not close software may also not switch the Industrial PC off, since data can be lost from the storage medium by switching off while software is running.



Attention

First shut down, then switch off!

If the Industrial PC is switched off as the software is writing a file to the storage medium, the file will be destroyed. Control software typically writes something to the storage medium every few seconds, so that the probability of causing damage by switching off while the software is running is very high.



Attention

Switch off power supply

When you have shut down the Industrial PC, you have to switch off power supply for at least 10 seconds before rebooting the system. After resetting power supply the Industrial PC will start booting automatically.

6.2 Touch screen

The operation of the Control Panel occurs via the Touch Screen.



Attention

Risk of damaging the Touch Screen

The touch screen may only be actuated by finger tips or with the touch screen pen. The operator may wear gloves but there must be no hard particles such as metal shavings, glass splinters embedded in the glove.



Attention

Properly installation of the system and the multi-touch device

Capacitive Touch Screens use the functional principle of capacitive alternation of the electrical field. Strong electrical fields can influence the functionality of the multi-touch devices. To ensure the correct function of the Touch Screen take care of a standardized installation of all parts of the system and an EMC-environment conforming to standards.

6.3 Servicing and maintenance

Cleaning

 WARNING	Disconnect power supply Switch off the device and all connected devices, and disconnect the device from the power supply.
---	---

The device can be cleaned with a soft, damp cleaning cloth. Do not use any aggressive cleaning materials, thinners, scouring material or hard objects that could cause scratches.

Maintenance

The Control Panel is maintenance-free. Do not open the Control Panel. For hardware problems, please contact the Beckhoff Service

6.4 Emergency procedures

In case of fire, the Control Panel should be extinguished with powder or nitrogen.

6.5 Shutting down

Disposal

 Note	Observe national electronics scrap regulations Observe the national electronics scrap regulations when disposing of the device.
--	---

In order to dispose of the device, it must be removed and fully dismantled:

- Housing components (polycarbonate, polyamide (PA6.6)) are suitable for plastic recycling.
- Metal parts can be sent for metal recycling.
- Electronic parts such as disk drives and circuit boards must be disposed of in accordance with national electronics scrap regulations.

7 Troubleshooting

 Note	<p>Pixel errors</p> <p>Pixel errors in the TFT display are production-caused and represent no complaint- reason!</p>
--	---

 Note	<p>Anomalies of the Touchscreen</p> <p>Anomalies of the touchscreen sensor are production-caused and represent no complaint-reason!</p>
--	--

Fault	Cause	Measures
The Control Panel shows no function	No power supply to the Control Panel/ Industrial PC Cable not connected	Check power supply cable 1. Correctly connect cable 2. Call Beckhoff Service
Computer boots, software starts, but control does not operate correctly	Cause of the fault is either in the software or in parts of the plant outside the Industrial PC	Call the manufacturer of the machine or the software
Malfunction of the touchscreen	Bad or missing ground connection of the device	Establish ground connection
	Bad or missing ground connection of the user	User must stand on the floor with ordinary shoes
USB error while TwinCAT access via USB	Cycle time in TwinCAT is set on 10 ms (standard)	Increase the cycle time up to 50 ms till 80 ms
The Control Panel functions only partially or only part of the time, e.g. no or dark picture	Faulty backlight in the display Defective components in the Control Panel	Call Beckhoff Service Call Beckhoff Service

8 Assembly dimensions

CPX2915-0000

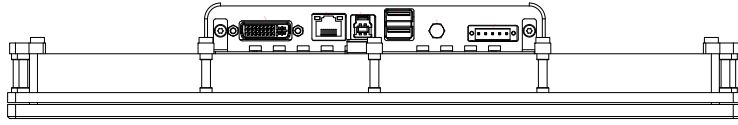

bottom view

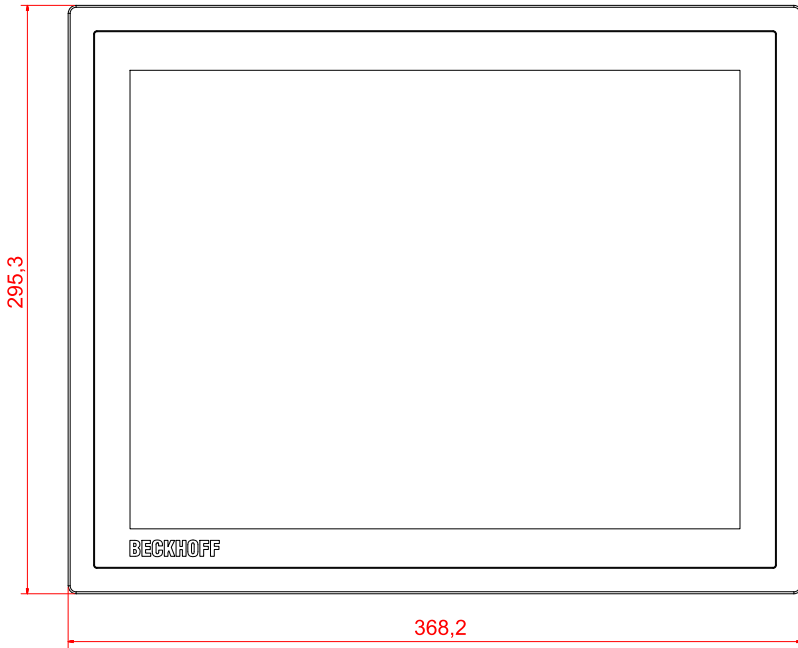

front view

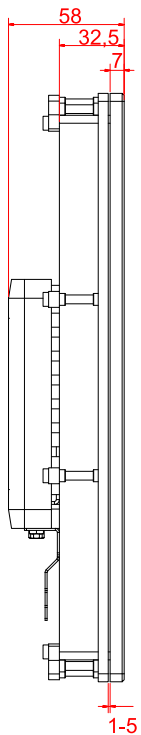

left view

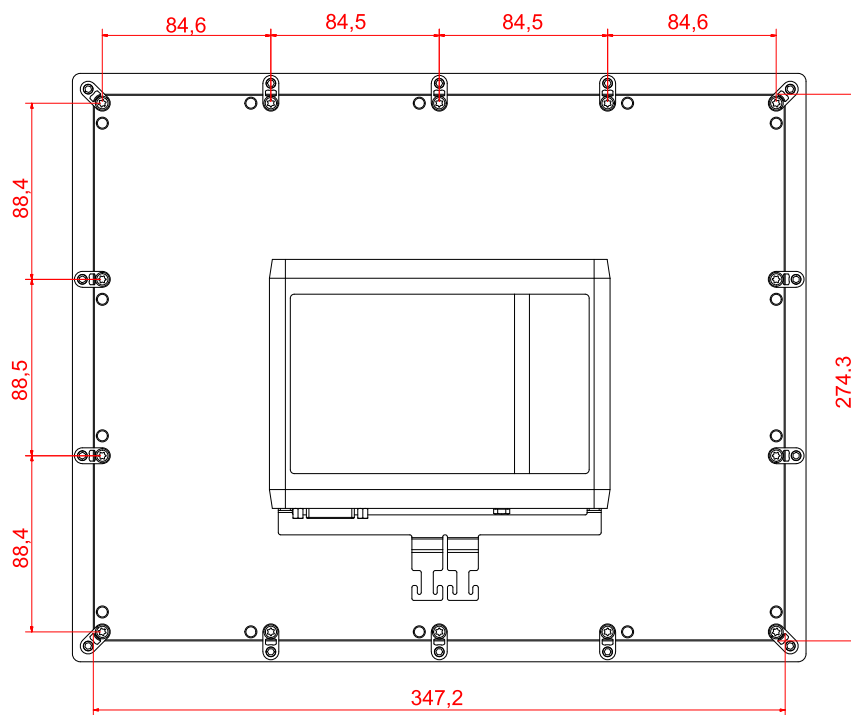

cutout dimensions: 274,3mm x 347,2mm

rear view

CPX2919-0000

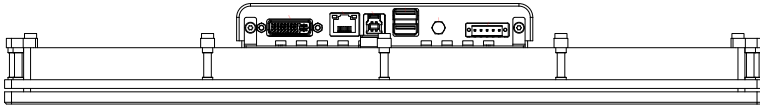

bottom view

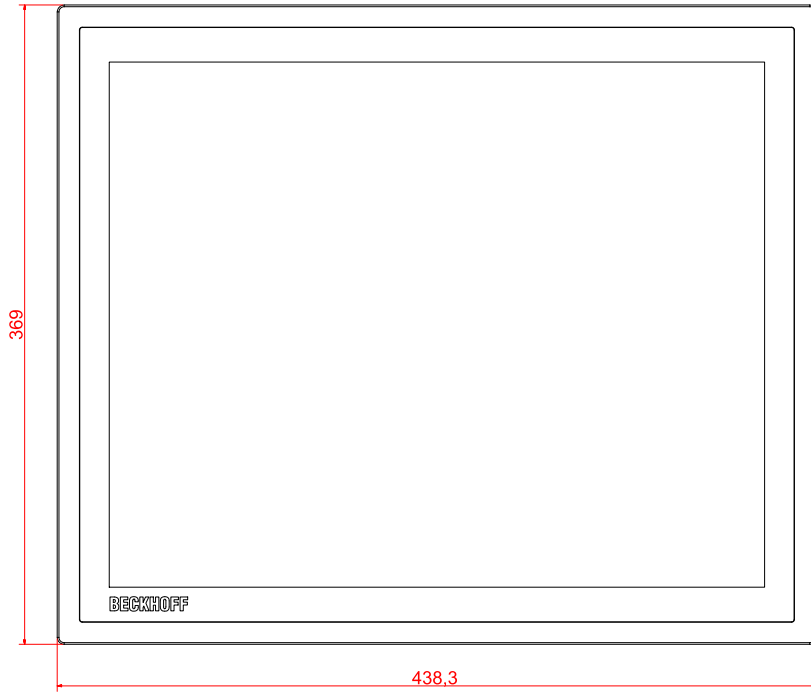

front view

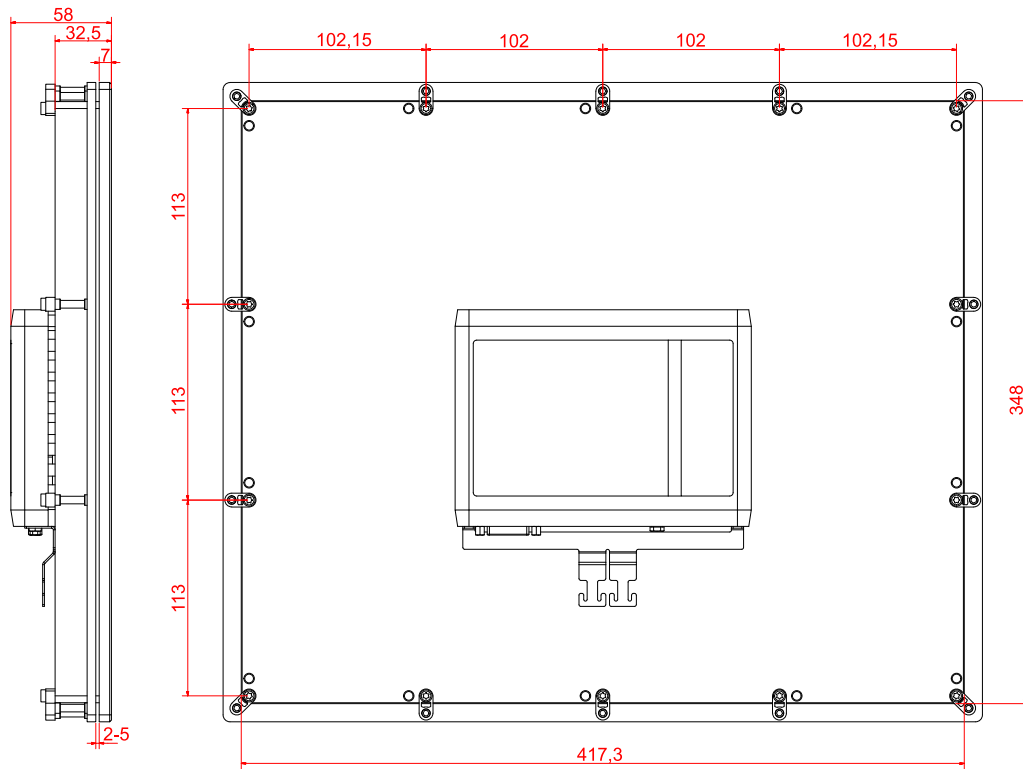

cutout dimensions: 1348mm x 417.3mm

left view

rear view

CPX2921-0000

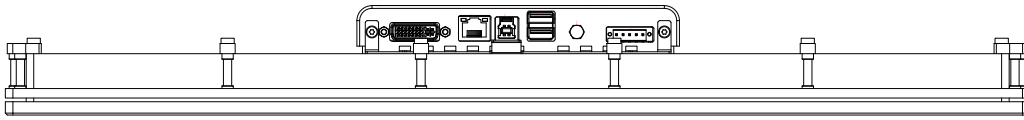

bottom view



front view

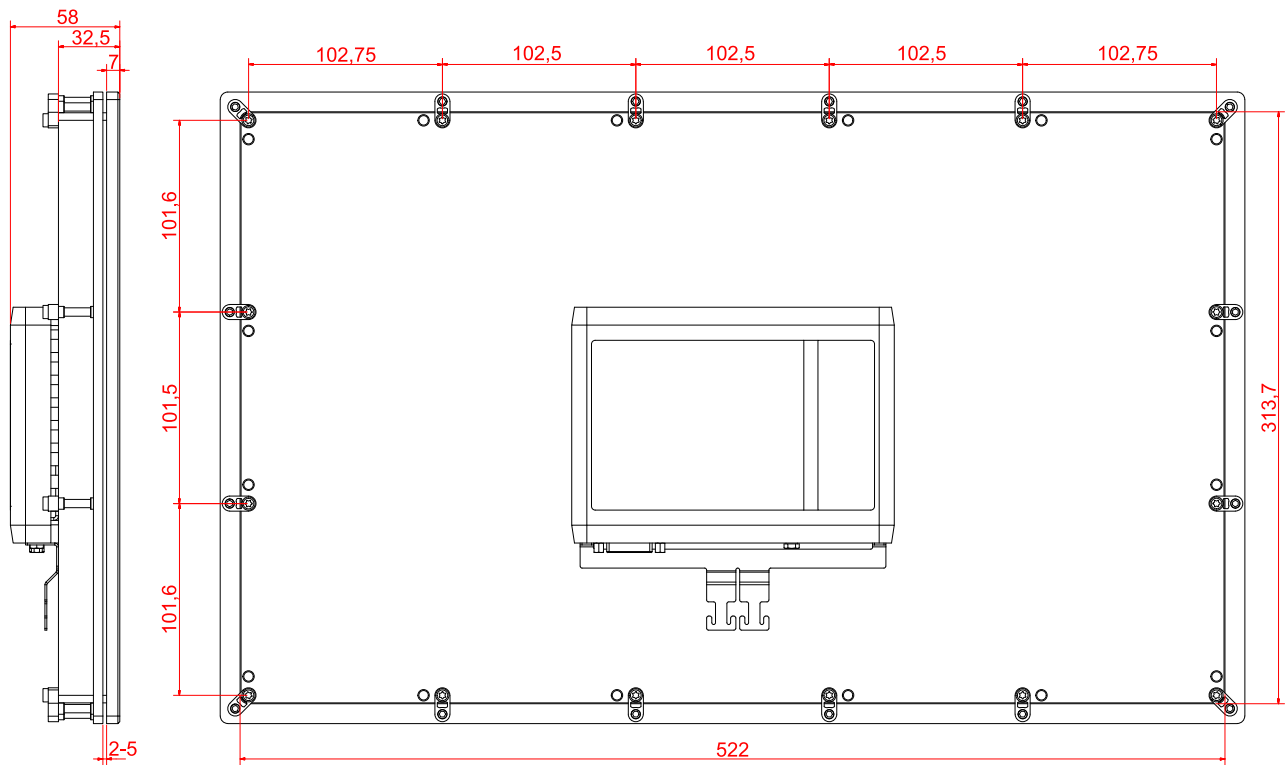

cutout dimensions: 522mm x 313,7mm

left view

rear view

9 Technical Data

Product name	CPX2915-0000	CPX2919-0000	CPX2921-0000
Dimensions (W x H x D)	368.2 x 295.3 x 58 mm	438,3 x 369 x 58 mm	543 x 334.7 x 58 mm
Weight	approx. 3.7 kg	approx. 5.4 kg	approx. 5.9 kg
Clamping Levers: tightening torque of the screws	1 to 1.2 Nm		
Supply voltage	24 V DC (22 – 30 V DC)		
Power consumption	max. 20 W	max. 25 W	max. 35 W
UL-compliance (in progress)	<ul style="list-style-type: none"> Using a power supply class 2 or Fuse protection with 4 A, according to UL 60950.2 chapter 2.5, table 2C 		
CPX29xx-0000: Integrated DVI/USB-extension technology	DVI-E and USB-E 2.0 enable remote panel operation at a distance of up to 50 m from the PC USB-E 2.0 transmits USB 2.0 with 480 Mbit/s DVI-E input is compatible to the standard DVI output of a PC		
Interfaces CPX29xx-0000	2-Port-USB-3.0/ USB 2.0, see: Description of the interfaces [► 17]		
Protection class	Front side IP65, rear side IP20		
Shock resistance (Sinusoidal vibration)	EN 60068-2-6:	10 bis 58 Hz:	0,035 mm
		58 bis 500 Hz	0,5 G (~ 5 m/ s ²)
Shock resistance (Shock)	EN 60068-2-27:	5 G (~ 50 m/ s ²), duration: 30 ms	
EMC compatibility	Resistance to interference conforms to EN 61000-6-2		
EMC compatibility	Emission of interference conforms to EN 61000-6-4		
Permissible ambient temperature	Operation: 0°C to +55°C (CPX29xx-0000) Transport/ storage: -20°C to +70°C		
Pollution degree	2		
Permissible relative humidity	to 95%, no condensation		
Transport and storage	The same values for atmospheric humidity and shock resistance are to be observed during transport and storage as in operation. Suitable packaging of the Panel PC can improve the resistance to impact during transport.		
Certifications	CE		

10 Appendix

10.1 Standards reference for explosive atmospheres

The following standards have been used:

ATEX

Standard	Description
EN 60079-0:2012+A11:2013	Explosive atmospheres - Part 0: Equipment - General requirements
EN 60079-7:2015	Explosive atmospheres - Part 7: Equipment protection by increased safety "e"
EN 60079-31:2014	Explosive atmospheres - Part 31: Equipment dust ignition protection by enclosure "t"

IECEx

Standard	Description
IEC 60079-0:2011	Explosive atmospheres - Part 0: Equipment - General requirements
IEC 60079-7:2015+A1:2017	Explosive atmospheres - Part 7: Equipment protection by increased safety "e"
IEC 60079-31:2013	Explosive atmospheres - Part 31: Equipment dust ignition protection by enclosure "t"

10.2 Connection Kits/ Connection Cables/Accessories

One 5-pole power supply connector is provided with the Control Panel. Optionally prefabricated connection kits for the DVI-D/ USB-E connection are available.

The following connection kits are available:

Table 2: Connection Kits DVI-D/ USB-E connection for CPX29xx-0000, optional

Connecting kit	DVI-E/ USB-E Connection
C9900-K622	Connecting kit 1 m for CPX29xx, containing: 1 m DVI cable, 1 m USB cable
C9900-K623	Connecting kit 3 m for CPX29xx, containing: 3 m DVI cable, 3 m USB cable
C9900-K624	Connecting kit 5 m for CPX29xx, containing: 5 m DVI cable, 5 m USB cable
C9900-K625	Anschlusskit 10 m für CPX29xx bestehend aus: 10 m DVI-Kabel, 10 m CAT-5-Kabel für USB-E-2.0, USB zu USB-E-2.0 Konverter CU8801 zur Hutschienenmontage neben dem PC und 1 m USB-Kabel für den Anschluss des USB-zu-USB-E-2.0-Konverters am PC
C9900-K626	Connecting kit 20 m for CPX29xx, containing: 20 m DVI cable, 20 m CAT 5 cable for USB-E-2.0, USB to USB-E-2.0 converter CU8801 for mounting rail installation close to the PC and 1 m USB cable to connect the USB to USB-E-2.0 converter to the PC
C9900-K627	Connecting kit 30 m for CPX29xx, containing: 30 m DVI cable, 30 m CAT 5 cable for USB-E-2.0, USB to USB-E-2.0 converter CU8801 for mounting rail installation close to the PC and 1 m USB cable to connect the USB to USB-E-2.0 converter to the PC
C9900-K628	Connecting kit 40 m for CPX29xx, containing: 40 m DVI cable, 40 m CAT 5 cable for USB-E-2.0, USB to USB-E-2.0 converter CU8801 for mounting rail installation close to the PC and 1 m USB cable to connect the USB to USB-E-2.0 converter to the PC
C9900-K629	Connecting kit 50 m for CPX29xx, containing: 50 m DVI cable, 50 m CAT 5 cable for USB-E-2.0, USB to USB-E-2.0 converter CU8801 for mounting rail installation close to the PC and 1 m USB cable to connect the USB to USB-E-2.0 converter to the PC

10.3 Approvals for USA and Canada

FCC: Federal Communications Commission Radio Frequency Interference Statement

This equipment has been tested and found to comply with the limits for a Class A digital device, pursuant to Part 15 of the FCC Rules. These limits are designed to provide reasonable protection against harmful interference when the equipment is operated in a commercial environment. This equipment generates, uses, and can radiate radio frequency energy and, if not installed and used in accordance with the instruction manual, may cause harmful interference to radio communications. Operation of this equipment in a residential area is likely to cause harmful interference in which case the user will be required to correct the interference at his own expense.



Note

Technical modifications

Technological changes to the device may cause the loss of the FCC approval.

FCC: Canadian Notice

This equipment does not exceed the Class A limits for radiated emissions as described in the Radio Interference Regulations of the Canadian Department of Communications.

10.4 Support and Service

Beckhoff and their partners around the world offer comprehensive support and service, making available fast and competent assistance with all questions related to Beckhoff products and system solutions.

Beckhoff's branch offices and representatives

Please contact your Beckhoff branch office or representative for local support and service on Beckhoff products!

The addresses of Beckhoff's branch offices and representatives round the world can be found on her internet pages:

<http://www.beckhoff.com>

You will also find further documentation for Beckhoff components there.

Beckhoff Headquarters

Beckhoff Automation GmbH & Co. KG

Huelshorstweg 20
33415 Verl
Germany

Phone:	+49(0)5246/963-0
Fax:	+49(0)5246/963-198
e-mail:	info@beckhoff.com

Beckhoff Support

Support offers you comprehensive technical assistance, helping you not only with the application of individual Beckhoff products, but also with other, wide-ranging services:

- support
- design, programming and commissioning of complex automation systems
- and extensive training program for Beckhoff system components

Hotline:	+49(0)5246/963-157
Fax:	+49(0)5246/963-9157
e-mail:	support@beckhoff.com

Beckhoff Service

The Beckhoff Service Center supports you in all matters of after-sales service:

- on-site service
- repair service
- spare parts service
- hotline service

Hotline:	+49(0)5246/963-460
Fax:	+49(0)5246/963-479
e-mail:	service@beckhoff.com