



Documentation

EL34x3

3-phase power measurement terminal

Version: 4.4
Date: 2019-03-28

BECKHOFF

Table of contents

1 Foreword	7
1.1 Product overview - Power measurement terminals	7
1.2 Notes on the documentation.....	7
1.3 Safety instructions	9
1.4 Documentation issue status	10
1.5 Version identification of EtherCAT devices	11
2 Product overview	16
2.1 EL3413	16
2.1.1 Introduction	16
2.1.2 Technical data	18
2.2 EL3433	19
2.2.1 Introduction	19
2.2.2 Technical data	20
2.3 Basic function principles	21
2.3.1 Measuring principle.....	21
2.3.2 RMS value calculation	21
2.3.3 Effective power measurement	22
2.3.4 Apparent power measurement	22
2.3.5 Sign for power measurement.....	24
2.3.6 Sign of the energy values	25
2.3.7 Frequency measurement.....	25
2.4 Current transformer	25
2.5 Start	26
3 Basics communication	27
3.1 EtherCAT basics.....	27
3.2 EtherCAT cabling – wire-bound.....	27
3.3 General notes for setting the watchdog.....	28
3.4 EtherCAT State Machine	30
3.5 CoE Interface.....	32
3.6 Distributed Clock	37
4 Installation	38
4.1 Instructions for ESD protection	38
4.2 Installation on mounting rails	38
4.3 Connection	41
4.3.1 Connection system	41
4.3.2 Wiring.....	44
4.3.3 Shielding	45
4.4 Installation positions	45
4.5 Positioning of passive Terminals	48
4.6 UL notice	48
4.7 EL34x3 - LEDs and connection	50
4.7.1 EL3413-0000	50
4.7.2 EL3413-0001	53

4.7.3	EL3413-0120	56
4.7.4	EL3433-0000	59
5	Commissioning.....	62
5.1	TwinCAT Quick Start	62
5.1.1	TwinCAT 2	65
5.1.2	TwinCAT 3	75
5.2	TwinCAT Development Environment	87
5.2.1	Installation of the TwinCAT real-time driver	87
5.2.2	Notes regarding ESI device description.....	93
5.2.3	TwinCAT ESI Updater	97
5.2.4	Distinction between Online and Offline.....	97
5.2.5	OFFLINE configuration creation	98
5.2.6	ONLINE configuration creation	103
5.2.7	EtherCAT subscriber configuration.....	111
5.3	General Notes - EtherCAT Slave Application.....	120
5.4	Process data.....	128
5.4.1	Sync Manager (SM).....	128
5.4.2	Operating modes and settings.....	131
5.4.3	Predefined PDO Assignment.....	133
5.5	Start-up and parameter configuration.....	133
5.5.1	Settings.....	133
5.5.2	Measurements.....	135
5.5.3	Scaling factors	139
5.6	Notices on analog specifications	140
5.6.1	Full scale value (FSV).....	141
5.6.2	Measuring error/ measurement deviation	141
5.6.3	Temperature coefficient tK [ppm/K]	142
5.6.4	Single-ended/differential typification	143
5.6.5	Common-mode voltage and reference ground (based on differential inputs).....	148
5.6.6	Dielectric strength	148
5.6.7	Temporal aspects of analog/digital conversion.....	149
5.7	Object description and parameterization	152
5.7.1	Restore object.....	152
5.7.2	Configuration data	153
5.7.3	Command object.....	153
5.7.4	Configuration data (vendor-specific).....	155
5.7.5	Input data	158
5.7.6	Output data	163
5.7.7	Information and diagnostic data.....	163
5.7.8	Standard objects.....	165
6	Diagnostics – basic principles of diag messages	173
7	Appendix	183
7.1	EtherCAT AL Status Codes	183
7.2	Firmware compatibility	183
7.3	Firmware Update EL/ES/EM/ELM/EPxxxx	184

7.3.1	Device description ESI file/XML.....	185
7.3.2	Firmware explanation	188
7.3.3	Updating controller firmware *.efw.....	189
7.3.4	FPGA firmware *.rbf.....	190
7.3.5	Simultaneous updating of several EtherCAT devices.....	194
7.4	Restoring the delivery state	195
7.5	Support and Service	196

1 Foreword

1.1 Product overview - Power measurement terminals

[EL3413 \[▶ 16\]](#)

3-phase power measurement terminal up to 690 V AC

[EL3413-0001 \[▶ 16\]](#)

3-phase power measurement terminal up to 600 V AC, UL approval

[EL3413-0120 \[▶ 16\]](#)

3-phase power measurement terminal up to 210 V AC

[EL3433 \[▶ 19\]](#)

3-phase power measurement terminal up to 500 V AC, 10 A

1.2 Notes on the documentation

Intended audience

This description is only intended for the use of trained specialists in control and automation engineering who are familiar with the applicable national standards.

It is essential that the documentation and the following notes and explanations are followed when installing and commissioning these components.

It is the duty of the technical personnel to use the documentation published at the respective time of each installation and commissioning.

The responsible staff must ensure that the application or use of the products described satisfy all the requirements for safety, including all the relevant laws, regulations, guidelines and standards.

Disclaimer

The documentation has been prepared with care. The products described are, however, constantly under development.

We reserve the right to revise and change the documentation at any time and without prior announcement.

No claims for the modification of products that have already been supplied may be made on the basis of the data, diagrams and descriptions in this documentation.

Trademarks

Beckhoff®, TwinCAT®, EtherCAT®, EtherCAT P®, Safety over EtherCAT®, TwinSAFE®, XFC® and XTS® are registered trademarks of and licensed by Beckhoff Automation GmbH.

Other designations used in this publication may be trademarks whose use by third parties for their own purposes could violate the rights of the owners.

Patent Pending

The EtherCAT Technology is covered, including but not limited to the following patent applications and patents: EP1590927, EP1789857, DE102004044764, DE102007017835 with corresponding applications or registrations in various other countries.

The TwinCAT Technology is covered, including but not limited to the following patent applications and patents: EP0851348, US6167425 with corresponding applications or registrations in various other countries.



EtherCAT® is registered trademark and patented technology, licensed by Beckhoff Automation GmbH, Germany.

Copyright

© Beckhoff Automation GmbH & Co. KG, Germany.

The reproduction, distribution and utilization of this document as well as the communication of its contents to others without express authorization are prohibited.

Offenders will be held liable for the payment of damages. All rights reserved in the event of the grant of a patent, utility model or design.

1.3 Safety instructions

Safety regulations

Please note the following safety instructions and explanations!
Product-specific safety instructions can be found on following pages or in the areas mounting, wiring, commissioning etc.

Exclusion of liability

All the components are supplied in particular hardware and software configurations appropriate for the application. Modifications to hardware or software configurations other than those described in the documentation are not permitted, and nullify the liability of Beckhoff Automation GmbH & Co. KG.

Personnel qualification

This description is only intended for trained specialists in control, automation and drive engineering who are familiar with the applicable national standards.

Description of instructions

In this documentation the following instructions are used.
These instructions must be read carefully and followed without fail!

DANGER

Serious risk of injury!

Failure to follow this safety instruction directly endangers the life and health of persons.

WARNING

Risk of injury!

Failure to follow this safety instruction endangers the life and health of persons.

CAUTION

Personal injuries!

Failure to follow this safety instruction can lead to injuries to persons.

NOTE

Damage to environment/equipment or data loss

Failure to follow this instruction can lead to environmental damage, equipment damage or data loss.



Tip or pointer

This symbol indicates information that contributes to better understanding.

1.4 Documentation issue status

Version	Comment
4.4	<ul style="list-style-type: none"> • Update chapter "LEDs and connection" • Update structure • Update revision status
4.3	<ul style="list-style-type: none"> • Update chapter "Technical data" • Update chapter "Connection system" -> "Connection" • Update structure • Update revision status
4.2	<ul style="list-style-type: none"> • Update revision status • Update structure
4.1	<ul style="list-style-type: none"> • Update chapter "Technical data" • Update structure
4.0	<ul style="list-style-type: none"> • Update chapter "Technical data" • Update chapter "Basic function principles" • Update chapter "Process data" • Update chapter "Start-up and parameter configuration" • Update chapter "Object description and parameterization" • Update revision status • Update structure
3.9	<ul style="list-style-type: none"> • Update chapter "Technical data" • Update structure
3.8	<ul style="list-style-type: none"> • Update chapter "Technical data" • Update chapter "Measurements" • Update structure
3.7	<ul style="list-style-type: none"> • Update chapter "Technical data" • Update chapter "Measurements" • Addenda chapter "Instructions for ESD protection" • Update chapter "Notices on Analog specification" • Update chapter "Diagnostics - basic principles of diag messages" • Update revision status
3.6	<ul style="list-style-type: none"> • Update chapter "Start-up and parameter configuration"
3.5	<ul style="list-style-type: none"> • Update chapter "Notes on the documentation" • Correction of Technical data • Addenda chapter "TwinCAT Quick Start" • Update chapter "Diagnostics – basic principles of diag messages"
3.4	<ul style="list-style-type: none"> • Update chapter "Object description" • Update revision status • Update structure
3.3	<ul style="list-style-type: none"> • Update chapter "Object description" • Update structure
3.2	<ul style="list-style-type: none"> • Update chapter "process data, setting" • Update structure
3.1	<ul style="list-style-type: none"> • Update chapter "scaling factors" • Update structure

Version	Comment
3.0	<ul style="list-style-type: none"> • Migration • Update structure • Update revision status
2.2	<ul style="list-style-type: none"> • Update chapter "Object description and parameterization" • "Technical data" section updated • Update revision status • Update structure
2.1	<ul style="list-style-type: none"> • "Technical data" section updated • Update revision status • Update structure
2.0	<ul style="list-style-type: none"> • Update chapter "Introduction" • Update chapter "Current transformer" • Update structure
1.9	<ul style="list-style-type: none"> • Addenda chapter "LEDs and connection" • Update chapter "Process data" • Update chapter "Measurements" • Update chapter "Object description and parameterization" • Update chapter "Scaling factors" • Update revision status • Update structure
1.8	<ul style="list-style-type: none"> • Addenda chapter "LEDs and connection"
1.7	<ul style="list-style-type: none"> • Update chapter "Scaling factors"
1.6	<ul style="list-style-type: none"> • Update structure • Addendum EL3413-0001, EL3413-0120, EL3433
1.5	<ul style="list-style-type: none"> • Update "Technical data"
1.4	<ul style="list-style-type: none"> • Update "Technical data"
1.3	<ul style="list-style-type: none"> • Update "Object description"
1.2	<ul style="list-style-type: none"> • Update "Object description"
1.1	<ul style="list-style-type: none"> • Update "Technical data"
1.0	<ul style="list-style-type: none"> • Addenda, 1st public issue
0.1	<ul style="list-style-type: none"> • Provisional documentation for EL3413

1.5 Version identification of EtherCAT devices

Designation

A Beckhoff EtherCAT device has a 14-digit designation, made up of

- family key
- type
- version
- revision

Example	Family	Type	Version	Revision
EL3314-0000-0016	EL terminal (12 mm, non-pluggable connection level)	3314 (4-channel thermocouple terminal)	0000 (basic type)	0016
ES3602-0010-0017	ES terminal (12 mm, pluggable connection level)	3602 (2-channel voltage measurement)	0010 (high-precision version)	0017
CU2008-0000-0000	CU device	2008 (8-port fast ethernet switch)	0000 (basic type)	0000

Notes

- The elements mentioned above result in the **technical designation**. EL3314-0000-0016 is used in the example below.
- EL3314-0000 is the order identifier, in the case of “-0000” usually abbreviated to EL3314. “-0016” is the EtherCAT revision.
- The **order identifier** is made up of
 - family key (EL, EP, CU, ES, KL, CX, etc.)
 - type (3314)
 - version (-0000)
- The **revision** -0016 shows the technical progress, such as the extension of features with regard to the EtherCAT communication, and is managed by Beckhoff.
In principle, a device with a higher revision can replace a device with a lower revision, unless specified otherwise, e.g. in the documentation.
Associated and synonymous with each revision there is usually a description (ESI, EtherCAT Slave Information) in the form of an XML file, which is available for download from the Beckhoff web site.
From 2014/01 the revision is shown on the outside of the IP20 terminals, see Fig. “*EL5021 EL terminal, standard IP20 IO device with batch number and revision ID (since 2014/01)*”.
- The type, version and revision are read as decimal numbers, even if they are technically saved in hexadecimal.

Identification number

Beckhoff EtherCAT devices from the different lines have different kinds of identification numbers:

Production lot/batch number/serial number/date code/D number

The serial number for Beckhoff IO devices is usually the 8-digit number printed on the device or on a sticker. The serial number indicates the configuration in delivery state and therefore refers to a whole production batch, without distinguishing the individual modules of a batch.

Structure of the serial number: **KK YY FF HH**

KK - week of production (CW, calendar week)
YY - year of production
FF - firmware version
HH - hardware version

Example with

Ser. no.: 12063A02: 12 - production week 12 06 - production year 2006 3A - firmware version 3A 02 - hardware version 02

Exceptions can occur in the **IP67 area**, where the following syntax can be used (see respective device documentation):

Syntax: D ww yy x y z u

D - prefix designation
ww - calendar week
yy - year
x - firmware version of the bus PCB
y - hardware version of the bus PCB
z - firmware version of the I/O PCB
u - hardware version of the I/O PCB

Example: D.22081501 calendar week 22 of the year 2008 firmware version of bus PCB: 1 hardware version of bus PCB: 5 firmware version of I/O PCB: 0 (no firmware necessary for this PCB) hardware version of I/O PCB: 1

Unique serial number/ID, ID number

In addition, in some series each individual module has its own unique serial number.

See also the further documentation in the area

- IP67: EtherCAT Box
- Safety: TwinSafe
- Terminals with factory calibration certificate and other measuring terminals

Examples of markings



Fig. 1: EL5021 EL terminal, standard IP20 IO device with serial/ batch number and revision ID (since 2014/01)



Fig. 2: EK1100 EtherCAT coupler, standard IP20 IO device with serial/ batch number



Fig. 3: CU2016 switch with serial/ batch number

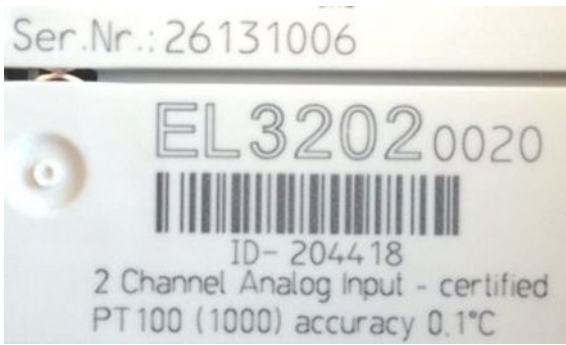

Fig. 4: EL3202-0020 with serial/ batch number 26131006 and unique ID-number 204418

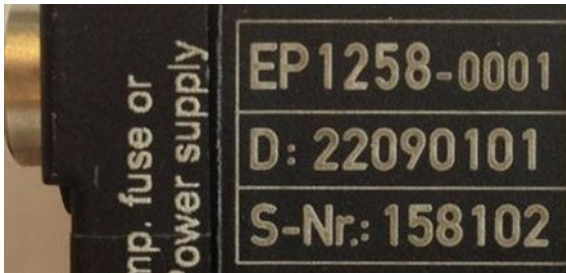

Fig. 5: EP1258-0001 IP67 EtherCAT Box with batch number/ date code 22090101 and unique serial number 158102

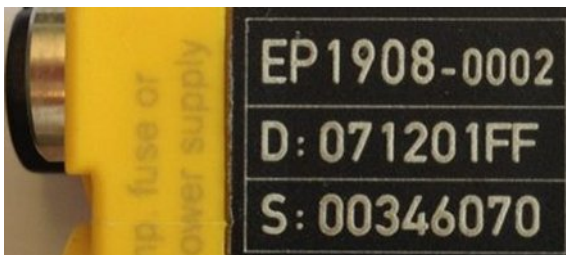

Fig. 6: EP1908-0002 IP67 EtherCAT Safety Box with batch number/ date code 071201FF and unique serial number 00346070



Fig. 7: EL2904 IP20 safety terminal with batch number/ date code 50110302 and unique serial number 00331701



Fig. 8: ELM3604-0002 terminal with unique ID number (QR code) 100001051 and serial/ batch number 44160201

2 Product overview

2.1 EL3413

2.1.1 Introduction

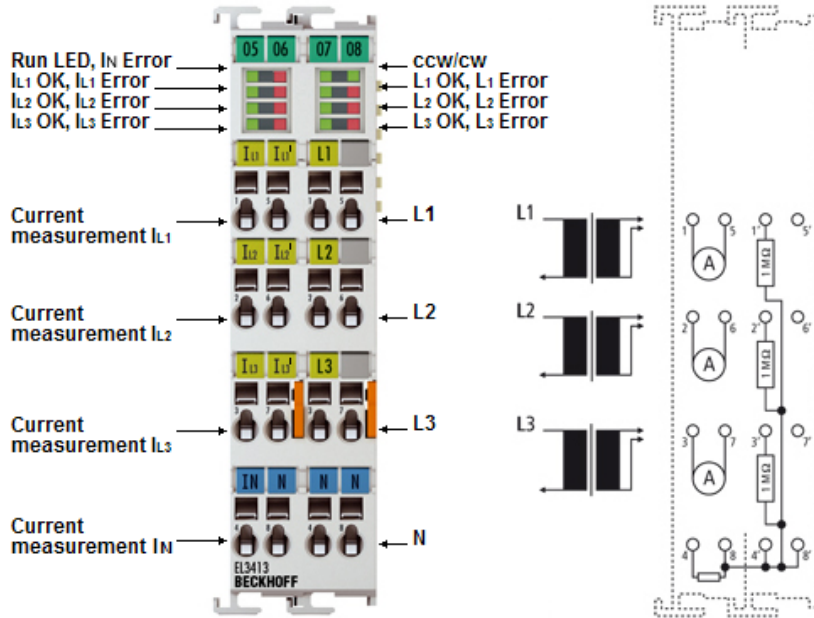

Fig. 9: EL3413

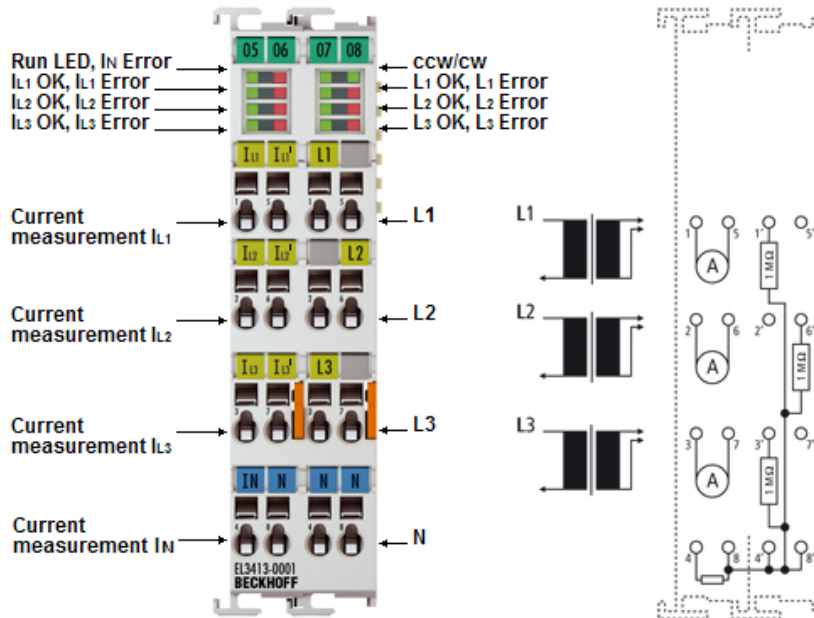

Fig. 10: EL3413-0001

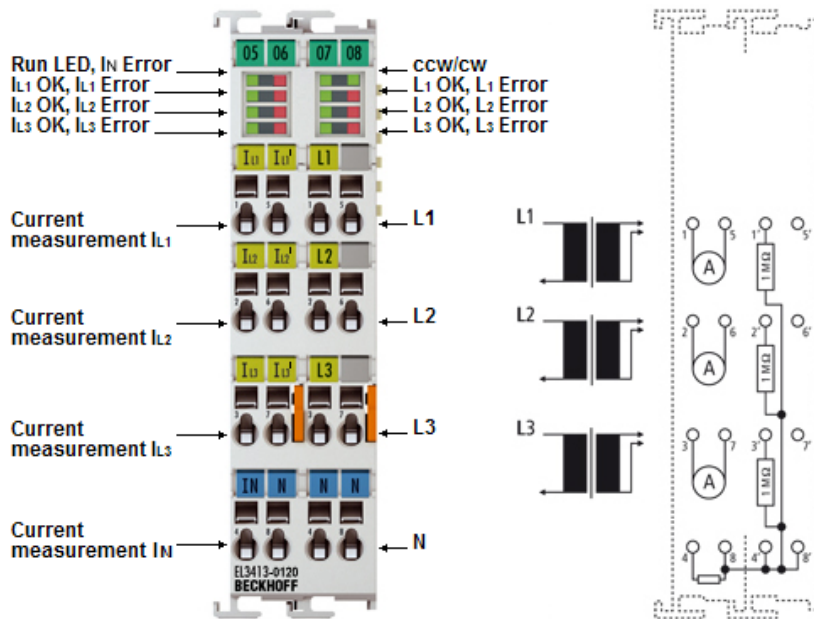

Fig. 11: EL3413-0120

3-Phase Power Measurement Terminal

The EL3413 EtherCAT power measurement terminal is a further development of the EL3403. With up to 690 V AC the voltage inputs are optimized for direct monitoring of high-performance generators, as used in the wind power industry, for sample.

The full scale value for the current can be set to 0.1 A, 1 A or 5 A via the CoE directory.

No upstream voltage transformer is required. The current inputs are electrically isolated so that the terminal can be used in all common grounded current transformer configurations such as 2- or 3-transformer configurations with star or delta connection.

Like all measured terminal data, the harmonic content can be read via the process data.

The EL3413-0001 has a maximum input voltage of 600 V AC and is additionally UL-certified. In the case of the EL3413-0120 the voltage range is limited to 210 V AC.

Quick links

- [EtherCAT basics](#)
- [Basic function principles EL34x3 \[► 21\]](#)
- [CoE object description and parameterization \[► 152\]](#)
- [Process data and operating modes \[► 128\]](#)

2.1.2 Technical data

Technical data	EL3413-0000	EL3413-0001	EL3413-0120
Measured values	Current, voltage, effective power, apparent power, frequency		
Calculated values	Reactive power, energy, power factor ($\cos\phi$), harmonic frequencies, phase angle		
Measuring voltage	max. 690 V AC 3~ (UL _x -N: max. 400 V AC)	max. 600 V AC 3~ (UL _x -N: max. 346 V AC)	max. 210 V AC 3~ (UL _x -N: max. 120 V AC)
	Fed-in voltages must comply with overvoltage category II		
Measuring current	max. 5 A (AC) (configurable), via measuring transformer x A / 5 A		
Input resistance voltage circuit (typ.)	1 MΩ		
Input resistance current circuit (typ.)	< 3 mΩ		
Fuse protection	Voltage circuit: according to the connected conductor size Current circuit: primary side of the current transformer, according to the connected conductor size		
Resolution	0.1 μA, 0.1 mV, 10 mW (0.1 A measuring range) 1 μA, 0.1 mV, 10 mW (1 A measuring range) 5 μA, 0.1 mV, 10 mW (5 A measuring range)	1 μA, 0.1 mV, 10 mW (1 A measuring range) 5 μA, 0.1 mV, 10 mW (5 A measuring range)	0.1 μA, 0.1 mV, 10 mW (0.1 A measuring range) 1 μA, 0.1 mV, 10 mW (1 A measuring range) 5 μA, 0.1 mV, 10 mW (5 A measuring range)
Measuring accuracy	0.5% in relation to the full scale value (U/I), 1% calculated value (P) Notice: For the EL3413, an accuracy of 2% FSV (full scale value) of the largest measuring range of the terminal is valid referring to the neutral conductor current measurement. The neutral conductor current measurement is only possible for this measuring range.		
Frequency range	45 Hz to 65 Hz		
Signal type	any (taking into account the frequency range and the limit frequency)		
Measuring procedure	True RMS calculation with 16,800 (2,800 per channel) samples/s		
Measuring cycle time	200 ms per measured value preset, freely configurable, mains-synchronous		
Electrical isolation	4500 V (connection terminal/E-bus)		
Supply voltage for electronic	via the E-bus		
E-Bus current consumption	typ. 160 mA		
Configuration	via TwinCAT System Manager		
Dimensions (W x H x D)	approx. 27 mm x 100 mm x 70 mm (width aligned: 24 mm)		
Weight	approx. 75 g		
Mounting [► 38]	on 35 mm mounting rail conforms to EN 60715		
Operating temperature	-25°C ... +60°C (extended temperature range)		
Storage temperature	-40°C ... +85°C		
Relative humidity	95 % no condensation		
Vibration/shock resistance	conforms to EN 60068-2-6 / EN 60068-2-27		
EMC immunity/emission	conforms to EN 61000-6-2 / EN 61000-6-4		
Protect. class / installation pos.	IP20/any		
Approvals	CE	CE cULus [► 48]	CE

2.2 EL3433

2.2.1 Introduction

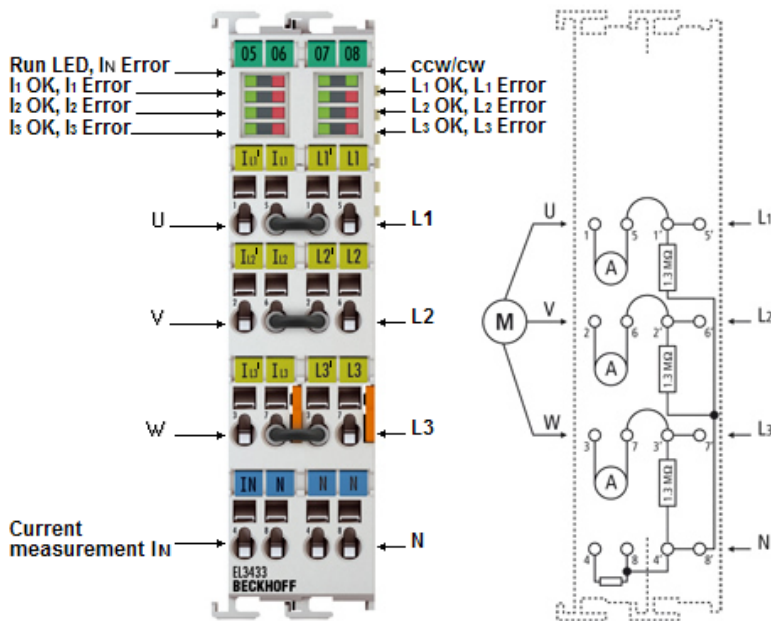

Fig. 12: EL3433

3-phase power measurement terminal, 500 V AC, 10 A

The EL3433 EtherCAT power measurement terminal is a further development of the EL3403.

Currents of up to 10 A can be directly measured with the internal current transformers. Hence, there are no additional costs for external current transformers. The external bridges 5 & 1', 6 & 2' and 7 & 3' are already pre-wired. As a result it is possible to directly connect the supply voltage (5', 6' and 7') and the consumer (1, 2 and 3).

The EL3433 can deal with simple network analysis up to the 21st harmonic analysis. Like all measured terminal data, the harmonic content can be read via the process data.

Quick links

- [EtherCAT basics](#)
- [Basic function principles EL34x3 \[▶ 21\]](#)
- [CoE object description and parameterization \[▶ 152\]](#)
- [Process data and operating modes \[▶ 128\]](#)

2.2.2 Technical data

Technical data	EL3433
Measured values	Current, voltage, effective power, apparent power, frequency
Calculated values	Reactive power, energy, power factor ($\cos\phi$), harmonic frequencies, phase angle
Measuring voltage	max. 500 V AC 3~ (UL _x -N: max. 288 V AC) Fed-in voltages must comply with overvoltage category II
Measuring current	max. 10 A (AC) (configurable)
Input resistance voltage circuit (typ.)	1 M Ω
Input resistance current circuit (typ.)	< 3 m Ω
Fuse protection	Voltage circuit: according to the connected conductor size Current circuit: primary side of the current transformer, according to the connected conductor size
Resolution	1 μ A, 0.1 mV, 10 mW
Measuring accuracy	0.5% in relation to the full scale value (U/I) (at 0°C...55°C) 1% in relation to the full scale value (U/I) (when the extended temperature range is used) 1% calculated value (P) Notice: For the EL3433, an accuracy of 2% FSV (full scale value) of the largest measuring range of the terminal is valid referring to the neutral conductor current measurement. The neutral conductor current measurement is only possible for this measuring range.
Frequency range	45 Hz to 65 Hz
Signal type	any (taking into account the frequency range and the limit frequency)
Measuring procedure	True RMS calculation with 16,800 (2,800 per channel) samples/s
Measuring cycle time	200 ms per measured value preset, freely configurable, mains-synchronous
Electrical isolation	4500 V (connection terminal/E-bus)
Supply voltage for electronic	via the E-bus
E-Bus current consumption	200 mA typ.
Configuration	via TwinCAT System Manager
Dimensions (W x H x D)	approx. 27 mm x 100 mm x 70 mm (width aligned: 24 mm)
Weight	approx. 100 g
Mounting [▶ 38]	on 35 mm mounting rail conforms to EN 60715
Operating temperature	-25 °C ... +60 °C (extended temperature range)
Storage temperature	-40 °C ... +85 °C
Relative humidity	95 % no condensation
Vibration/shock resistance	conforms to EN 60068-2-6 / EN 60068-2-27
EMC immunity/emission	conforms to EN 61000-6-2 / EN 61000-6-4
Protect. class / installation pos.	IP20/any
Approvals	CE cULus [▶ 48]

2.3 Basic function principles

2.3.1 Measuring principle

The EL34x3 terminals operate with 1 analog/digital converter for measuring the current and voltage variables of all three phases.

The measurement and processing of the three phases take place successively (45 µs offset) in exactly the same way. The signal processing for one phase is described below. This description applies correspondingly for all three phases.

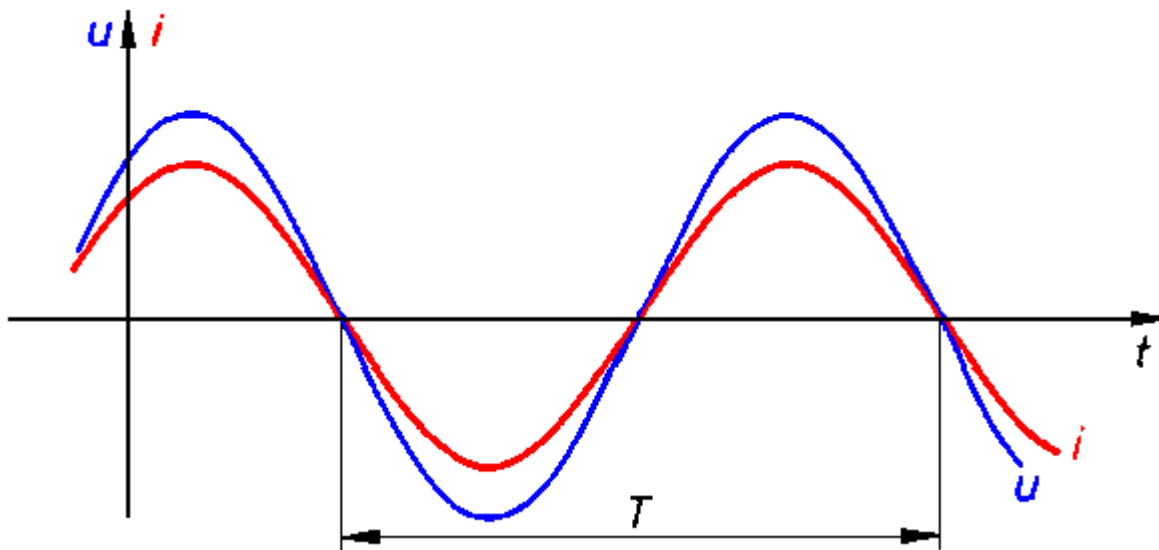

Fig. 13: Voltage u and current i curves

2.3.2 RMS value calculation

The rms value for voltage and current is calculated over a measuring interval, in this case the period T . The following equations are used:

$$U = \sqrt{\frac{1}{n} \sum_{1}^n u_{(t)}^2}$$

$$I = \sqrt{\frac{1}{n} \sum_{1}^n i_{(t)}^2}$$

$u_{(t)}$: instantaneous voltage value

$i_{(t)}$: instantaneous current value

n : number of measured values

Measuring interval

The choice of the right measuring interval is important for the quality of the measurement. The default setting for the measuring interval is 10 periods (10 x 20 ms). Experience shows that this is a good compromise between measuring speed and stability. Deviations from this value are only advisable in the event of particular measurement requirements (e.g. high measuring speed).

2.3.3 Effective power measurement

The EL34x3 measures the effective power P according to the following equation

$$P = \frac{1}{n} \sum_{k=1}^n u_{(t)} \cdot i_{(t)}$$

P : Active power

n : Number of samples

$u_{(t)}$: Instantaneous voltage value

$i_{(t)}$: instantaneous current value

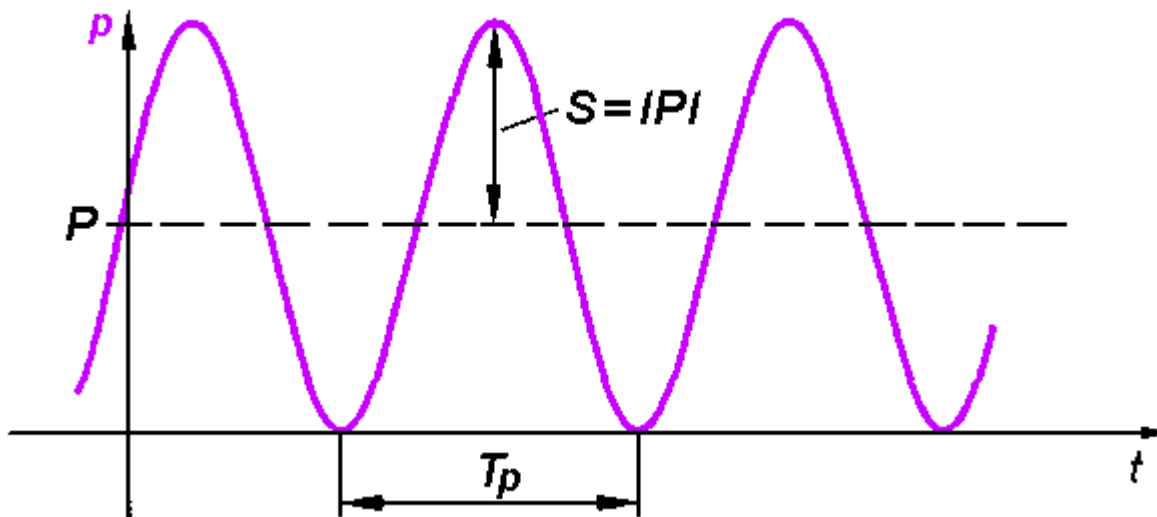

Fig. 14: Power $s_{(t)}$ curve

In the first step, the power $s_{(t)}$ is calculated at each sampling instant:

$$s_{(t)} = u_{(t)} \cdot i_{(t)}$$

The mean value over the measuring interval is calculated. Here too, the correct choice of the intervals is important, as described in section RMS value measurement (the interval can only be changed simultaneously for U , I and P).

The power frequency is twice that of the corresponding voltages and currents.

2.3.4 Apparent power measurement

In real networks, not all consumers are purely ohmic. Phase shifts occur between current and voltage. This does not affect the methodology for determining the rms values of voltage and current as described above.

The situation for the effective power is different: Here, the product of effective voltage and effective current is the apparent power.

$$S = U \cdot I$$

The effective power is smaller than the apparent power.

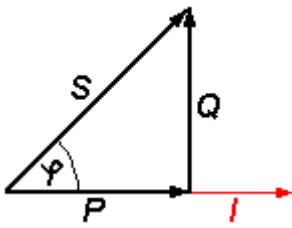

S: Apparent power
 P: Active power
 Q: Reactive power
 φ : Phase shift angle

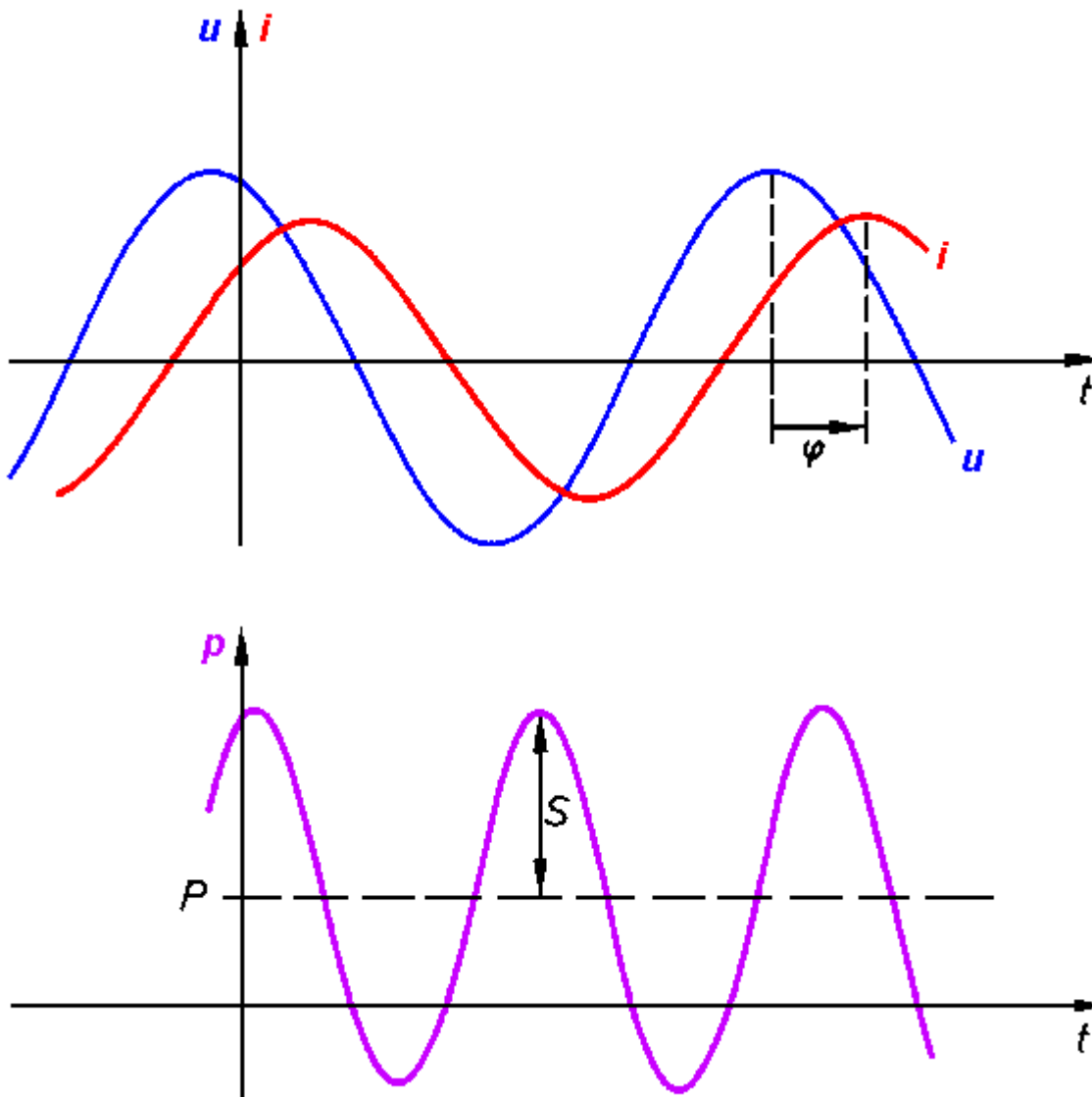

Fig. 15: $u_{(t)}$, $i_{(t)}$, $p_{(t)}$ curves with phase shift angle φ

In this context, further parameters of the mains system and its consumers are significant:

- apparent power S
- reactive power Q
- power factor $\cos \varphi$

The EL34x3 determines the following values:

- effective power P
- effective voltage U
- effective current I
- apparent power S
- reactive power Q
- power factor $\cos \varphi$
- harmonic
- phase shift λ

2.3.5 Sign for power measurement

The sign of the active power P and of the power factor $\cos \varphi$ provide about information the direction of the energy flow. A positive sign indicates the motor mode, a negative sign indicates generator mode.

In addition, the sign of the reactive power Q indicates the direction of the phase shift between current and voltage. Fig. *Four-quadrant representation of active/reactive power in motor and generator mode* illustrates this. In motor mode (quadrant I & IV) a positive reactive power indicates an inductive load, a negative reactive power indicates a capacitive load. In generator mode (quadrant II & III), an inductive acting generator is indicated by a positive reactive power, a capacitive acting generator by a negative reactive power.

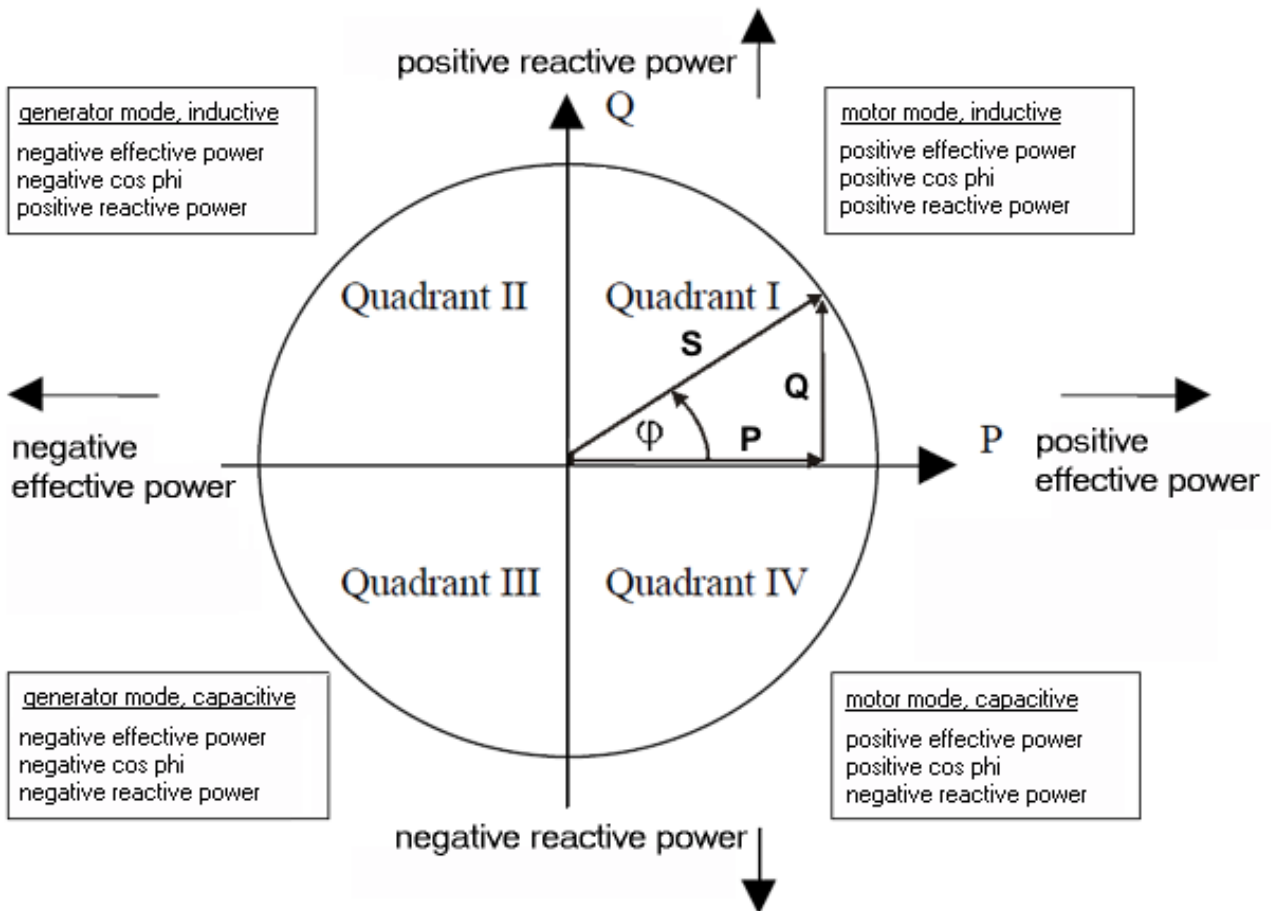

Fig. 16: Four-quadrant representation of active/reactive power in motor and generator mode

2.3.6 Sign of the energy values

Name	Index	Variant Value	AUX channel		CoE	
			Sum (Ch 0)	Channel access (Ch 11/12/13)	0x90n0	0xF801 ^{*)}
Energy difference	2	E+ - E-	$\sum E+ - \sum E- $	E+ - E-	N/A	N/A
Energy negative	5	- E-	$\sum E- $	E-	E-	E-
Energy positive	30	E+	$\sum E+ $	E+	E+	E+
Energy difference (automatically saved)	32	E+ - E-	$\sum E+ - \sum E- $	E+ - E-	N/A	N/A
Energy negative (automatically saved)	35	- E-	$\sum E- $	E-	E-	E-
Positive energy (automatically saved)	31	E+	E+	E+	E+	E+

*) Access only possible from PLC

2.3.7 Frequency measurement

The EL34x3 can measure the frequency of the input signals at a voltage circuit (L1, L2 or L3).

Held frequency

The last frequency is displayed via indexes 46, 47 and 48, "Held Frequency", before one or more channels report an "Undervoltage" or "Missing Zero Crossing" error.

The values may not represent the actual mains frequency (see also last note in chapter "[PM Inputs Channel 1/2/3](#) [[▶ 137](#)]").

2.4 Current transformer

In principle, the choice of current transformer for the EL34x3 is not critical. The internal resistance within the current circuit of the EL34x3 is so small that it is negligible for the calculation of the total resistances of the current loop. The transformers must be able to supply a secondary rated current in accordance with the set measuring range. The primary rated current I_{pn} can be selected arbitrarily. The common permissible overload of $1.2 \times I_{pn}$ is no problem for the EL34x3, but may lead to small measuring inaccuracies.

Accuracy

Please note that the overall accuracy of the set-up consisting of EL34x3 and current transformers to a large degree depends on the accuracy class of the transformers.

● No approval as a billing meter



A set-up with a class 0.5 current transformer cannot be approved or authenticated. The EL34x3 is not an approved billing meter according to the electricity meter standard (DIN 43 856).

Current types

The EL34x3 terminals can measure AC currents with a frequency of 45 Hz to 65 Hz and up to their 21st harmonic. Since such currents are frequently created by inverters and may contain frequencies of less than 50 Hz or even a DC component, electronic transformers should be used for such applications.

Overcurrent limiting factor FS

The overcurrent limiting factor FS of a current transformer indicates at what multiple of the primary rated current the current transformer changes to saturation mode, in order to protect the connected measuring instruments.

NOTE

Attention! Risk of damage to the device!

The EL34x3 terminals may not be continuously loaded with more than 5 A [EL3413-xxxx] or 10 A [EL3433-xxxx] respectively! Additional intermediate transformers must be used in systems in which the overcurrent limiting factors of the transformer allow higher secondary currents!

Protection against dangerous touch voltages

During appropriate operation of the EL34x3 with associated current transformers, no dangerous voltages occur. The secondary voltage is in the range of a few Volts. However, the following faults may lead to excessive voltages:

- Open current circuit of one or several transformers
- Neutral conductor cut on the voltage measurement side of the EL34x3
- General insulation fault

⚠ WARNING

WARNING Risk of electric shock!

The complete wiring of the EL34x3 must be protected against accidental contact and equipped with associated warnings! The insulation should be designed for the maximum conductor voltage of the system to be measured!

The [EL3413-xxxxx \[► 18\]](#) or [EL3433-xxxx \[► 20\]](#) allows the maximum voltage for normal conditions as specified in the technical data. The conductor voltage on the current side must not exceed this value! For higher voltages, an intermediate transformer stage should be used!

An EL34x3 is equipped with a protective impedance of typically 1 MΩ on the voltage measurement side. If the neutral conductor is not connected and only one connection is live on the voltage measurement side, the resulting voltage against earth in a 3-phase system with a specific [line-to-line voltage \[► 18\]](#) is reduced by the factor $\sqrt{3}$. This should also be measured on the side of the current measurement using a multimeter with an internal resistance of 10 MΩ, which does not represent an insulation fault.

Additional measuring instruments in the current circuit

Please note that the addition of additional measuring instruments (e.g. ammeters) in the current circuit can lead to a significant increase in the total apparent power.

2.5 Start

For commissioning:

- mount the EL34x3 as described in the chapter [Mounting and wiring \[► 38\]](#)
- configure the EL34x3 in TwinCAT as described in the chapter [Commissioning \[► 62\]](#).

3 Basics communication

3.1 EtherCAT basics

Please refer to the [EtherCAT System Documentation](#) for the EtherCAT fieldbus basics.

3.2 EtherCAT cabling – wire-bound

The cable length between two EtherCAT devices must not exceed 100 m. This results from the FastEthernet technology, which, above all for reasons of signal attenuation over the length of the cable, allows a maximum link length of 5 + 90 + 5 m if cables with appropriate properties are used. See also the [Design recommendations for the infrastructure for EtherCAT/Ethernet](#).

Cables and connectors

For connecting EtherCAT devices only Ethernet connections (cables + plugs) that meet the requirements of at least category 5 (Cat5) according to EN 50173 or ISO/IEC 11801 should be used. EtherCAT uses 4 wires for signal transfer.

EtherCAT uses RJ45 plug connectors, for example. The pin assignment is compatible with the Ethernet standard (ISO/IEC 8802-3).

Pin	Color of conductor	Signal	Description
1	yellow	TD +	Transmission Data +
2	orange	TD -	Transmission Data -
3	white	RD +	Receiver Data +
6	blue	RD -	Receiver Data -

Due to automatic cable detection (auto-crossing) symmetric (1:1) or cross-over cables can be used between EtherCAT devices from Beckhoff.

● Recommended cables

i Suitable cables for the connection of EtherCAT devices can be found on the [Beckhoff website!](#)

E-Bus supply

A bus coupler can supply the EL terminals added to it with the E-bus system voltage of 5 V; a coupler is thereby loadable up to 2 A as a rule (see details in respective device documentation). Information on how much current each EL terminal requires from the E-bus supply is available online and in the catalogue. If the added terminals require more current than the coupler can supply, then power feed terminals (e.g. [EL9410](#)) must be inserted at appropriate places in the terminal strand.

The pre-calculated theoretical maximum E-Bus current is displayed in the TwinCAT System Manager. A shortfall is marked by a negative total amount and an exclamation mark; a power feed terminal is to be placed before such a position.

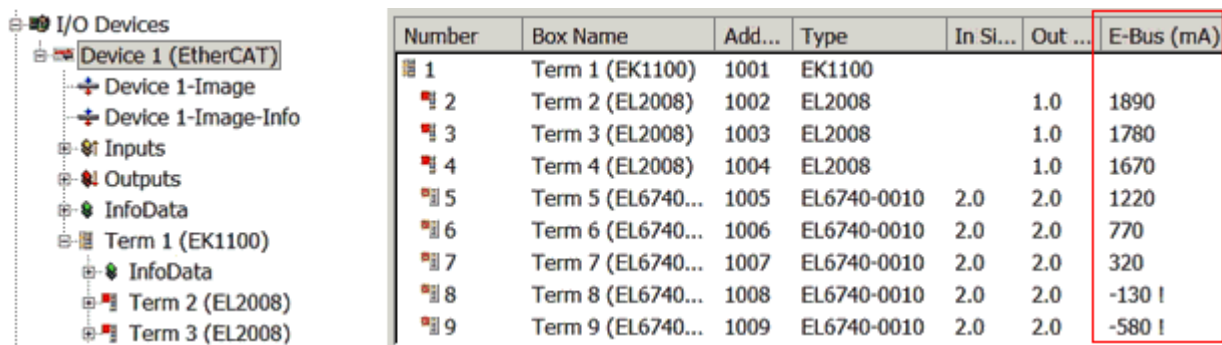

Fig. 17: System manager current calculation

NOTE

Malfunction possible!
 The same ground potential must be used for the E-Bus supply of all EtherCAT terminals in a terminal block!

3.3 General notes for setting the watchdog

ELxxxx terminals are equipped with a safety feature (watchdog) that switches off the outputs after a specifiable time e.g. in the event of an interruption of the process data traffic, depending on the device and settings, e.g. in OFF state.

The EtherCAT slave controller (ESC) in the EL2xxx terminals features 2 watchdogs:

- SM watchdog (default: 100 ms)
- PDI watchdog (default: 100 ms)

SM watchdog (SyncManager Watchdog)

The SyncManager watchdog is reset after each successful EtherCAT process data communication with the terminal. If no EtherCAT process data communication takes place with the terminal for longer than the set and activated SM watchdog time, e.g. in the event of a line interruption, the watchdog is triggered and the outputs are set to FALSE. The OP state of the terminal is unaffected. The watchdog is only reset after a successful EtherCAT process data access. Set the monitoring time as described below.

The SyncManager watchdog monitors correct and timely process data communication with the ESC from the EtherCAT side.

PDI watchdog (Process Data Watchdog)

If no PDI communication with the EtherCAT slave controller (ESC) takes place for longer than the set and activated PDI watchdog time, this watchdog is triggered.

PDI (Process Data Interface) is the internal interface between the ESC and local processors in the EtherCAT slave, for example. The PDI watchdog can be used to monitor this communication for failure.

The PDI watchdog monitors correct and timely process data communication with the ESC from the application side.

The settings of the SM- and PDI-watchdog must be done for each slave separately in the TwinCAT System Manager.

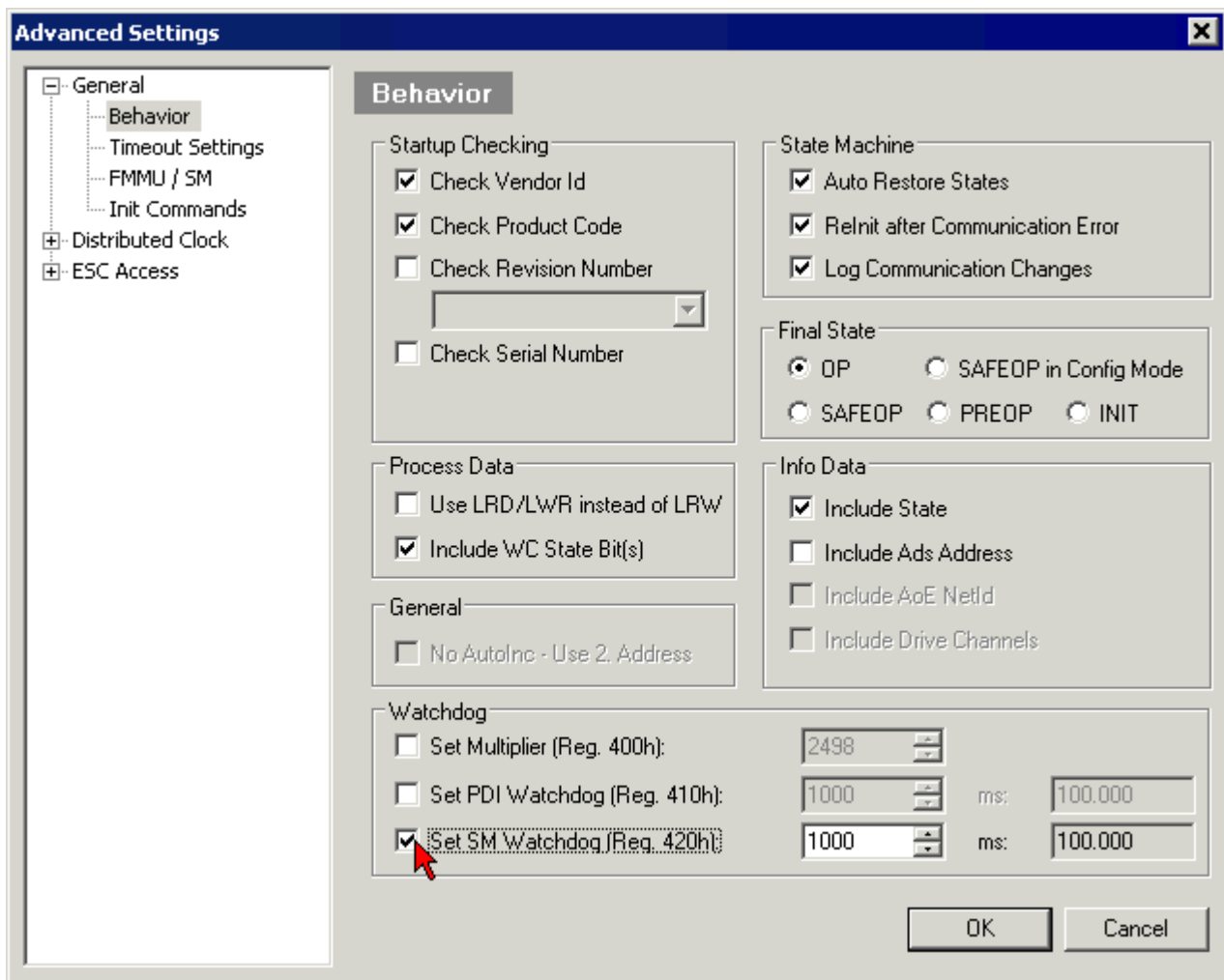

Fig. 18: EtherCAT tab -> Advanced Settings -> Behavior -> Watchdog

Notes:

- the multiplier is valid for both watchdogs.
- each watchdog has its own timer setting, the outcome of this in summary with the multiplier is a resulting time.
- Important: the multiplier/timer setting is only loaded into the slave at the start up, if the checkbox is activated.
If the checkbox is not activated, nothing is downloaded and the ESC settings remain unchanged.

Multiplier

Multiplier

Both watchdogs receive their pulses from the local terminal cycle, divided by the watchdog multiplier:

$$1/25 \text{ MHz} * (\text{watchdog multiplier} + 2) = 100 \mu\text{s} \text{ (for default setting of 2498 for the multiplier)}$$

The standard setting of 1000 for the SM watchdog corresponds to a release time of 100 ms.

The value in multiplier + 2 corresponds to the number of basic 40 ns ticks representing a watchdog tick. The multiplier can be modified in order to adjust the watchdog time over a larger range.

Example "Set SM watchdog"

This checkbox enables manual setting of the watchdog times. If the outputs are set and the EtherCAT communication is interrupted, the SM watchdog is triggered after the set time and the outputs are erased. This setting can be used for adapting a terminal to a slower EtherCAT master or long cycle times. The default SM watchdog setting is 100 ms. The setting range is 0..65535. Together with a multiplier with a range of 1..65535 this covers a watchdog period between 0..~170 seconds.

Calculation

Multiplier = 2498 → watchdog base time = $1 / 25 \text{ MHz} * (2498 + 2) = 0.0001 \text{ seconds} = 100 \mu\text{s}$

SM watchdog = 10000 → $10000 * 100 \mu\text{s} = 1 \text{ second watchdog monitoring time}$

⚠ CAUTION

Undefined state possible!

The function for switching off of the SM watchdog via SM watchdog = 0 is only implemented in terminals from version -0016. In previous versions this operating mode should not be used.

⚠ CAUTION

Damage of devices and undefined state possible!

If the SM watchdog is activated and a value of 0 is entered the watchdog switches off completely. This is the deactivation of the watchdog! Set outputs are NOT set in a safe state, if the communication is interrupted.

3.4 EtherCAT State Machine

The state of the EtherCAT slave is controlled via the EtherCAT State Machine (ESM). Depending upon the state, different functions are accessible or executable in the EtherCAT slave. Specific commands must be sent by the EtherCAT master to the device in each state, particularly during the bootup of the slave.

A distinction is made between the following states:

- Init
- Pre-Operational
- Safe-Operational and
- Operational
- Boot

The regular state of each EtherCAT slave after bootup is the OP state.

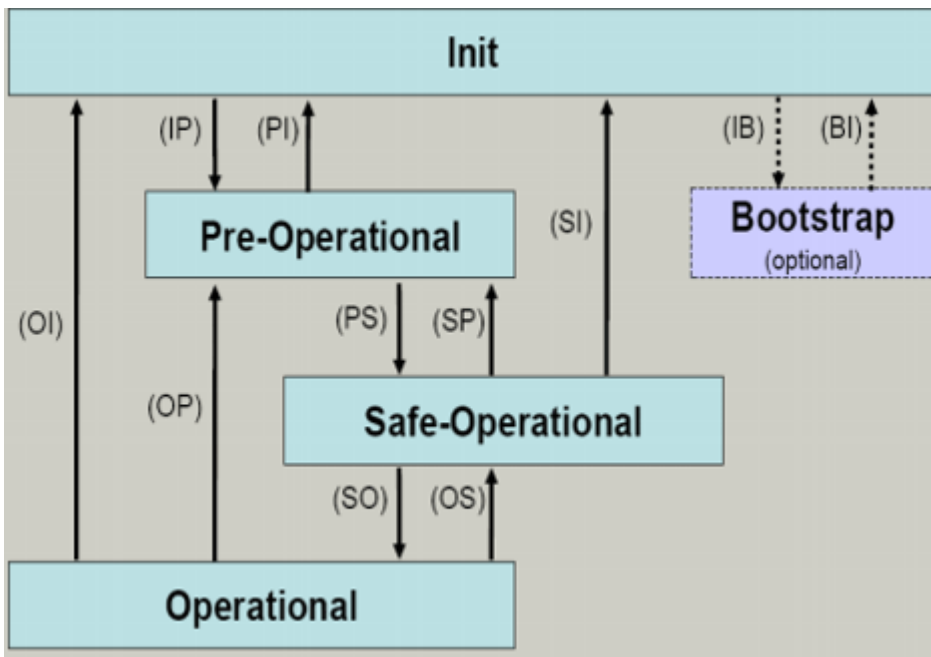

Fig. 19: States of the EtherCAT State Machine

Init

After switch-on the EtherCAT slave in the *Init* state. No mailbox or process data communication is possible. The EtherCAT master initializes sync manager channels 0 and 1 for mailbox communication.

Pre-Operational (Pre-Op)

During the transition between *Init* and *Pre-Op* the EtherCAT slave checks whether the mailbox was initialized correctly.

In *Pre-Op* state mailbox communication is possible, but not process data communication. The EtherCAT master initializes the sync manager channels for process data (from sync manager channel 2), the FMMU channels and, if the slave supports configurable mapping, PDO mapping or the sync manager PDO assignment. In this state the settings for the process data transfer and perhaps terminal-specific parameters that may differ from the default settings are also transferred.

Safe-Operational (Safe-Op)

During transition between *Pre-Op* and *Safe-Op* the EtherCAT slave checks whether the sync manager channels for process data communication and, if required, the distributed clocks settings are correct. Before it acknowledges the change of state, the EtherCAT slave copies current input data into the associated DP-RAM areas of the EtherCAT slave controller (ECSC).

In *Safe-Op* state mailbox and process data communication is possible, although the slave keeps its outputs in a safe state, while the input data are updated cyclically.

● **Outputs in SAFEOP state**

i The default set `watchdog` [▶ 28] monitoring sets the outputs of the module in a safe state - depending on the settings in `SAFEOP` and `OP` - e.g. in `OFF` state. If this is prevented by deactivation of the watchdog monitoring in the module, the outputs can be switched or set also in the `SAFEOP` state.

Operational (Op)

Before the EtherCAT master switches the EtherCAT slave from *Safe-Op* to *Op* it must transfer valid output data.

In the *Op* state the slave copies the output data of the masters to its outputs. Process data and mailbox communication is possible.

Boot

In the *Boot* state the slave firmware can be updated. The *Boot* state can only be reached via the *Init* state.

In the *Boot* state mailbox communication via the *file access over EtherCAT* (FoE) protocol is possible, but no other mailbox communication and no process data communication.

3.5 CoE Interface

General description

The CoE interface (CANopen over EtherCAT) is used for parameter management of EtherCAT devices. EtherCAT slaves or the EtherCAT master manage fixed (read only) or variable parameters which they require for operation, diagnostics or commissioning.

CoE parameters are arranged in a table hierarchy. In principle, the user has read access via the fieldbus. The EtherCAT master (TwinCAT System Manager) can access the local CoE lists of the slaves via EtherCAT in read or write mode, depending on the attributes.

Different CoE parameter types are possible, including string (text), integer numbers, Boolean values or larger byte fields. They can be used to describe a wide range of features. Examples of such parameters include manufacturer ID, serial number, process data settings, device name, calibration values for analog measurement or passwords.

The order is specified in 2 levels via hexadecimal numbering: (main)index, followed by subindex. The value ranges are

- Index: 0x0000 ...0xFFFF (0...65535_{dez})
- SubIndex: 0x00...0xFF (0...255_{dez})

A parameter localized in this way is normally written as 0x8010:07, with preceding "x" to identify the hexadecimal numerical range and a colon between index and subindex.

The relevant ranges for EtherCAT fieldbus users are:

- 0x1000: This is where fixed identity information for the device is stored, including name, manufacturer, serial number etc., plus information about the current and available process data configurations.
- 0x8000: This is where the operational and functional parameters for all channels are stored, such as filter settings or output frequency.

Other important ranges are:

- 0x4000: In some EtherCAT devices the channel parameters are stored here (as an alternative to the 0x8000 range).
- 0x6000: Input PDOs ("input" from the perspective of the EtherCAT master)
- 0x7000: Output PDOs ("output" from the perspective of the EtherCAT master)

● Availability



Not every EtherCAT device must have a CoE list. Simple I/O modules without dedicated processor usually have no variable parameters and therefore no CoE list.

If a device has a CoE list, it is shown in the TwinCAT System Manager as a separate tab with a listing of the elements:

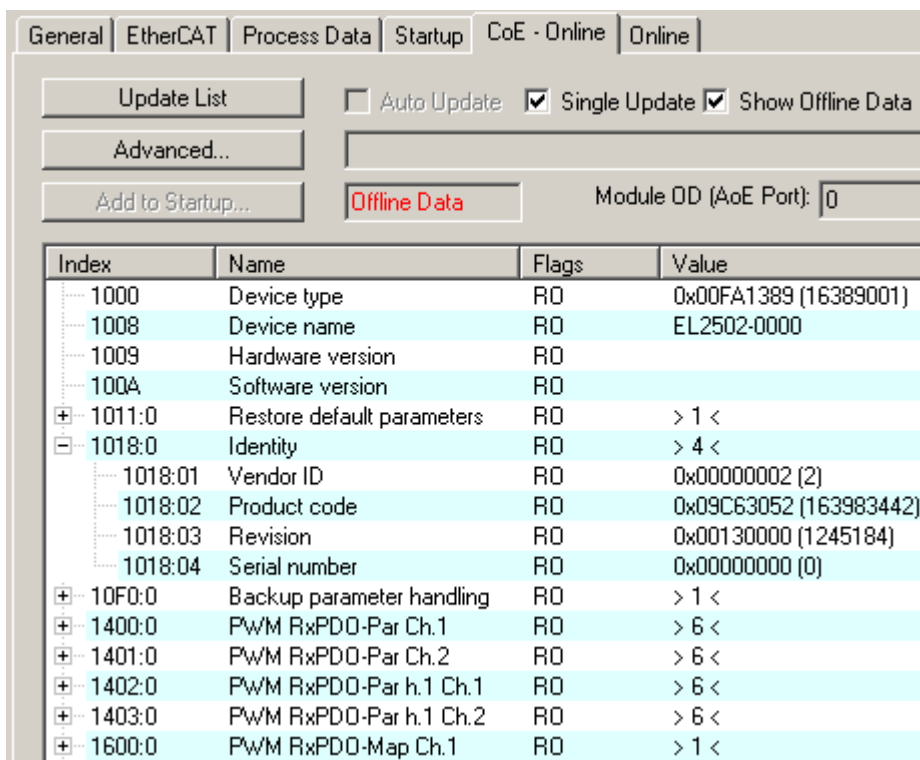

Fig. 20: "CoE Online " tab

The figure above shows the CoE objects available in device "EL2502", ranging from 0x1000 to 0x1600. The subindices for 0x1018 are expanded.

Data management and function "NoCoeStorage"

Some parameters, particularly the setting parameters of the slave, are configurable and writeable. This can be done in write or read mode

- via the System Manager (Fig. "CoE Online " tab) by clicking
This is useful for commissioning of the system/slaves. Click on the row of the index to be parameterised and enter a value in the "SetValue" dialog.
- from the control system/PLC via ADS, e.g. through blocks from the TcEtherCAT.lib library
This is recommended for modifications while the system is running or if no System Manager or operating staff are available.

i Data management

If slave CoE parameters are modified online, Beckhoff devices store any changes in a fail-safe manner in the EEPROM, i.e. the modified CoE parameters are still available after a restart. The situation may be different with other manufacturers.

An EEPROM is subject to a limited lifetime with respect to write operations. From typically 100,000 write operations onwards it can no longer be guaranteed that new (changed) data are reliably saved or are still readable. This is irrelevant for normal commissioning. However, if CoE parameters are continuously changed via ADS at machine runtime, it is quite possible for the lifetime limit to be reached. Support for the NoCoeStorage function, which suppresses the saving of changed CoE values, depends on the firmware version.

Please refer to the technical data in this documentation as to whether this applies to the respective device.

- If the function is supported: the function is activated by entering the code word 0x12345678 once in CoE 0xF008 and remains active as long as the code word is not changed. After switching the device on it is then inactive. Changed CoE values are not saved in the EEPROM and can thus be changed any number of times.
- Function is not supported: continuous changing of CoE values is not permissible in view of the lifetime limit.

i Startup list

Changes in the local CoE list of the terminal are lost if the terminal is replaced. If a terminal is replaced with a new Beckhoff terminal, it will have the default settings. It is therefore advisable to link all changes in the CoE list of an EtherCAT slave with the Startup list of the slave, which is processed whenever the EtherCAT fieldbus is started. In this way a replacement EtherCAT slave can automatically be parameterized with the specifications of the user.

If EtherCAT slaves are used which are unable to store local CoE values permanently, the Startup list must be used.

Recommended approach for manual modification of CoE parameters

- Make the required change in the System Manager
The values are stored locally in the EtherCAT slave
- If the value is to be stored permanently, enter it in the Startup list.
The order of the Startup entries is usually irrelevant.

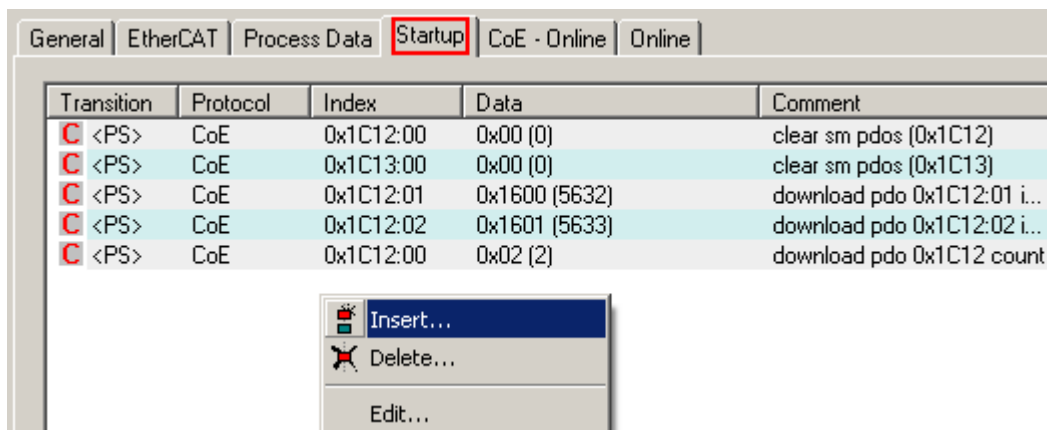

Fig. 21: Startup list in the TwinCAT System Manager

The Startup list may already contain values that were configured by the System Manager based on the ESI specifications. Additional application-specific entries can be created.

Online/offline list

While working with the TwinCAT System Manager, a distinction has to be made whether the EtherCAT device is "available", i.e. switched on and linked via EtherCAT and therefore **online**, or whether a configuration is created **offline** without connected slaves.

In both cases a CoE list as shown in Fig. "CoE online' tab" is displayed. The connectivity is shown as offline/online.

- If the slave is offline
 - The offline list from the ESI file is displayed. In this case modifications are not meaningful or possible.
 - The configured status is shown under Identity.
 - No firmware or hardware version is displayed, since these are features of the physical device.
 - **Offline** is shown in red.

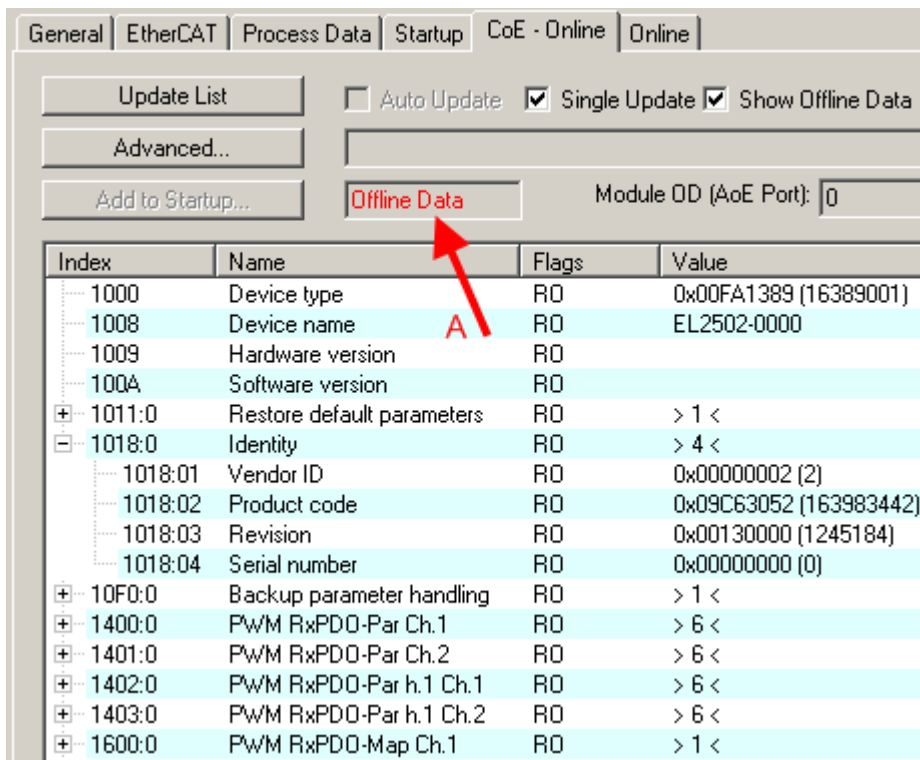

Fig. 22: Offline list

- If the slave is online
 - The actual current slave list is read. This may take several seconds, depending on the size and cycle time.
 - The actual identity is displayed
 - The firmware and hardware version of the equipment according to the electronic information is displayed
 - **Online** is shown in green.

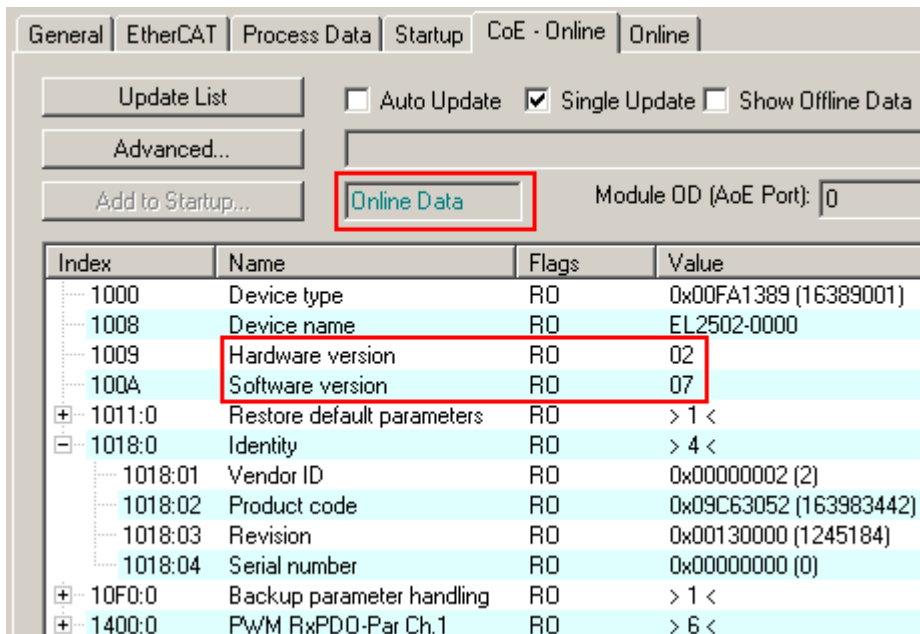

Fig. 23: Online list

Channel-based order

The CoE list is available in EtherCAT devices that usually feature several functionally equivalent channels. For example, a 4-channel analog 0..10 V input terminal also has 4 logical channels and therefore 4 identical sets of parameter data for the channels. In order to avoid having to list each channel in the documentation, the placeholder "n" tends to be used for the individual channel numbers.

In the CoE system 16 indices, each with 255 subindices, are generally sufficient for representing all channel parameters. The channel-based order is therefore arranged in $16_{\text{dec}}/10_{\text{hex}}$ steps. The parameter range 0x8000 exemplifies this:

- Channel 0: parameter range 0x8000:00 ... 0x800F:255
- Channel 1: parameter range 0x8010:00 ... 0x801F:255
- Channel 2: parameter range 0x8020:00 ... 0x802F:255
- ...

This is generally written as 0x80n0.

Detailed information on the CoE interface can be found in the [EtherCAT system documentation](#) on the Beckhoff website.

3.6 Distributed Clock

Distributed Clock. The EL34x3 terminals do not support Distributed Clocks.

4 Installation

4.1 Instructions for ESD protection

NOTE

Destruction of the devices by electrostatic discharge possible!

The devices contain components at risk from electrostatic discharge caused by improper handling.

- Please ensure you are electrostatically discharged and avoid touching the contacts of the device directly.
- Avoid contact with highly insulating materials (synthetic fibers, plastic film etc.).
- Surroundings (working place, packaging and personnel) should be grounded probably, when handling with the devices.
- Each assembly must be terminated at the right hand end with an [EL9011](#) or [EL9012](#) bus end cap, to ensure the protection class and ESD protection.

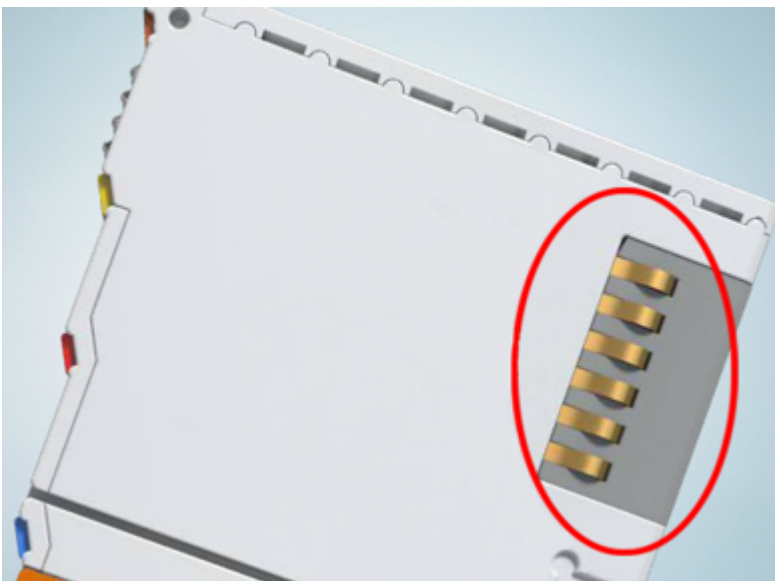

Fig. 24: Spring contacts of the Beckhoff I/O components

4.2 Installation on mounting rails

⚠ WARNING

Risk of electric shock and damage of device!

Bring the bus terminal system into a safe, powered down state before starting installation, disassembly or wiring of the bus terminals!

Assembly

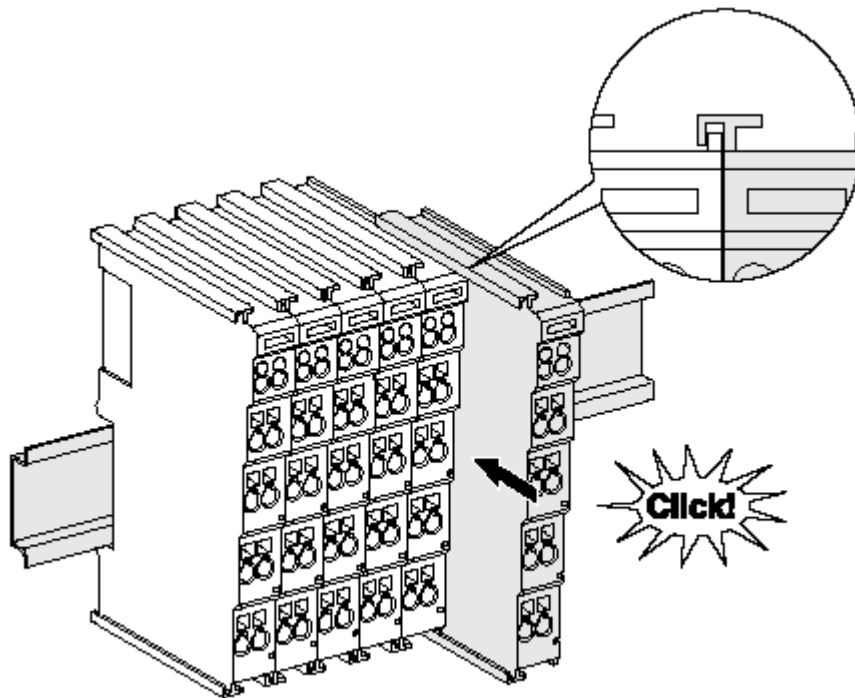

Fig. 25: Attaching on mounting rail

The bus coupler and bus terminals are attached to commercially available 35 mm mounting rails (DIN rails according to EN 60715) by applying slight pressure:

1. First attach the fieldbus coupler to the mounting rail.
2. The bus terminals are now attached on the right-hand side of the fieldbus coupler. Join the components with tongue and groove and push the terminals against the mounting rail, until the lock clicks onto the mounting rail.

If the terminals are clipped onto the mounting rail first and then pushed together without tongue and groove, the connection will not be operational! When correctly assembled, no significant gap should be visible between the housings.

i Fixing of mounting rails

The locking mechanism of the terminals and couplers extends to the profile of the mounting rail. At the installation, the locking mechanism of the components must not come into conflict with the fixing bolts of the mounting rail. To mount the mounting rails with a height of 7.5 mm under the terminals and couplers, you should use flat mounting connections (e.g. countersunk screws or blind rivets).

Disassembly

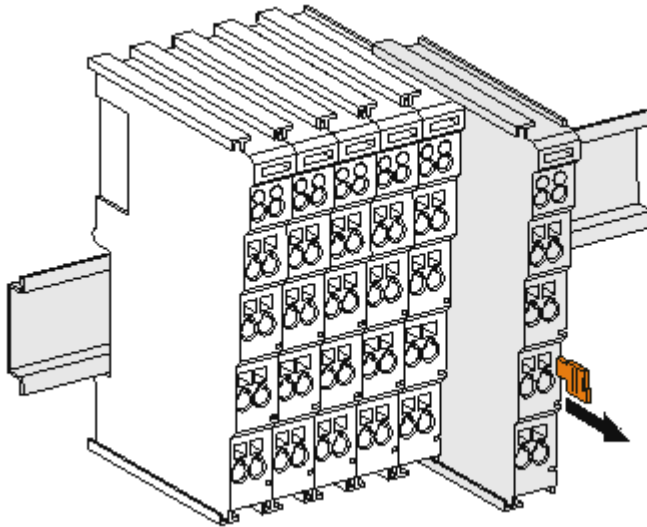

Fig. 26: Disassembling of terminal

Each terminal is secured by a lock on the mounting rail, which must be released for disassembly:

1. Pull the terminal by its orange-colored lugs approximately 1 cm away from the mounting rail. In doing so for this terminal the mounting rail lock is released automatically and you can pull the terminal out of the bus terminal block easily without excessive force.
2. Grasp the released terminal with thumb and index finger simultaneous at the upper and lower grooved housing surfaces and pull the terminal out of the bus terminal block.

Connections within a bus terminal block

The electric connections between the Bus Coupler and the Bus Terminals are automatically realized by joining the components:

- The six spring contacts of the K-Bus/E-Bus deal with the transfer of the data and the supply of the Bus Terminal electronics.
- The power contacts deal with the supply for the field electronics and thus represent a supply rail within the bus terminal block. The power contacts are supplied via terminals on the Bus Coupler (up to 24 V) or for higher voltages via power feed terminals.

i Power Contacts

During the design of a bus terminal block, the pin assignment of the individual Bus Terminals must be taken account of, since some types (e.g. analog Bus Terminals or digital 4-channel Bus Terminals) do not or not fully loop through the power contacts. Power Feed Terminals (KL91xx, KL92xx or EL91xx, EL92xx) interrupt the power contacts and thus represent the start of a new supply rail.

PE power contact

The power contact labeled PE can be used as a protective earth. For safety reasons this contact mates first when plugging together, and can ground short-circuit currents of up to 125 A.

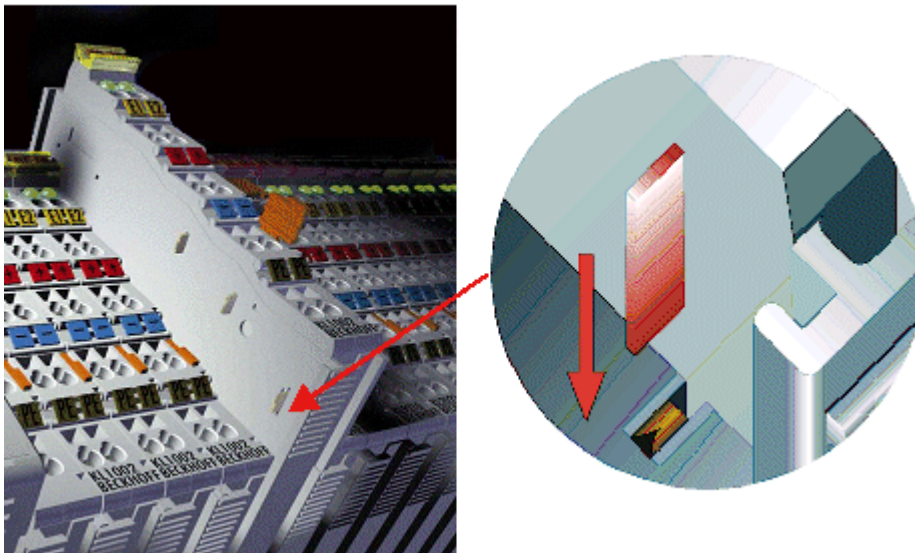

Fig. 27: Power contact on left side

NOTE

Possible damage of the device

Note that, for reasons of electromagnetic compatibility, the PE contacts are capacitatively coupled to the mounting rail. This may lead to incorrect results during insulation testing or to damage on the terminal (e.g. disruptive discharge to the PE line during insulation testing of a consumer with a nominal voltage of 230 V). For insulation testing, disconnect the PE supply line at the Bus Coupler or the Power Feed Terminal! In order to decouple further feed points for testing, these Power Feed Terminals can be released and pulled at least 10 mm from the group of terminals.

⚠ WARNING

Risk of electric shock!

The PE power contact must not be used for other potentials!

4.3 Connection

4.3.1 Connection system

⚠ WARNING

Risk of electric shock and damage of device!

Bring the bus terminal system into a safe, powered down state before starting installation, disassembly or wiring of the bus terminals!

Overview

The Bus Terminal system offers different connection options for optimum adaptation to the respective application:

- The terminals of ELxxxx and KLxxxx series with standard wiring include electronics and connection level in a single enclosure.
- The terminals of ESxxxx and KSxxxx series feature a pluggable connection level and enable steady wiring while replacing.
- The High Density Terminals (HD Terminals) include electronics and connection level in a single enclosure and have advanced packaging density.

Standard wiring (ELxxxx / KLxxxx)

Fig. 28: Standard wiring

The terminals of ELxxxx and KLxxxx series have been tried and tested for years. They feature integrated screwless spring force technology for fast and simple assembly.

Pluggable wiring (ESxxxx / KSxxxx)

Fig. 29: Pluggable wiring

The terminals of ESxxxx and KSxxxx series feature a pluggable connection level. The assembly and wiring procedure is the same as for the ELxxxx and KLxxxx series. The pluggable connection level enables the complete wiring to be removed as a plug connector from the top of the housing for servicing. The lower section can be removed from the terminal block by pulling the unlocking tab. Insert the new component and plug in the connector with the wiring. This reduces the installation time and eliminates the risk of wires being mixed up.

The familiar dimensions of the terminal only had to be changed slightly. The new connector adds about 3 mm. The maximum height of the terminal remains unchanged.

A tab for strain relief of the cable simplifies assembly in many applications and prevents tangling of individual connection wires when the connector is removed.

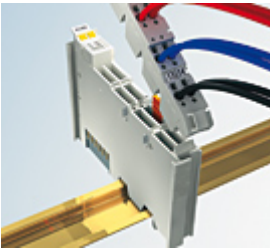
Conductor cross sections between 0.08 mm² and 2.5 mm² can continue to be used with the proven spring force technology.

The overview and nomenclature of the product names for ESxxxx and KSxxxx series has been retained as known from ELxxxx and KLxxxx series.

High Density Terminals (HD Terminals)Fig. 30: *High Density Terminals*

The Bus Terminals from these series with 16 terminal points are distinguished by a particularly compact design, as the packaging density is twice as large as that of the standard 12 mm Bus Terminals. Massive conductors and conductors with a wire end sleeve can be inserted directly into the spring loaded terminal point without tools.

● Wiring HD Terminals

i The High Density (HD) Terminals of the ELx8xx and KLx8xx series doesn't support pluggable wiring.

Ultrasonically "bonded" (ultrasonically welded) conductors

● Ultrasonically "bonded" conductors

i It is also possible to connect the Standard and High Density Terminals with ultrasonically "bonded" (ultrasonically welded) conductors. In this case, please note the tables concerning the wire-size width below!

4.3.2 Wiring

⚠ WARNING

Risk of electric shock and damage of device!

Bring the bus terminal system into a safe, powered down state before starting installation, disassembly or wiring of the Bus Terminals!

Terminals for standard wiring ELxxxx/KLxxxx and for pluggable wiring ESxxxx/KSxxxx

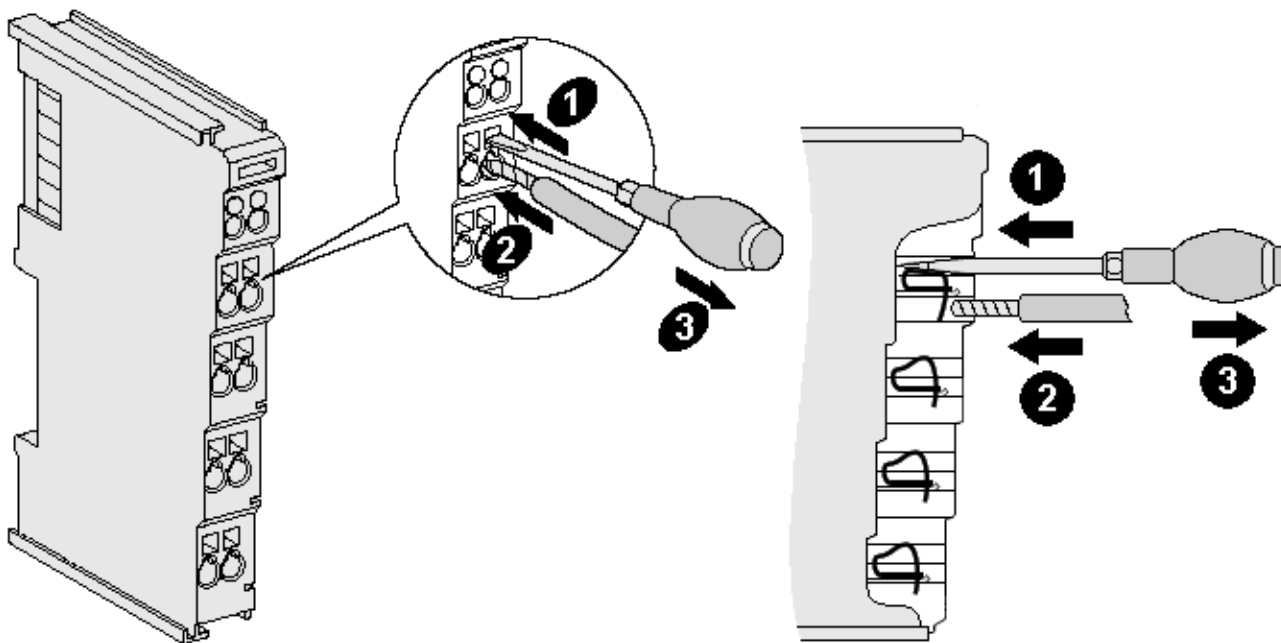

Fig. 31: Connecting a cable on a terminal point

Up to eight terminal points enable the connection of solid or finely stranded cables to the Bus Terminal. The terminal points are implemented in spring force technology. Connect the cables as follows:

1. Open a terminal point by pushing a screwdriver straight against the stop into the square opening above the terminal point. Do not turn the screwdriver or move it alternately (don't toggle).
2. The wire can now be inserted into the round terminal opening without any force.
3. The terminal point closes automatically when the pressure is released, holding the wire securely and permanently.

See the following table for the suitable wire size width.

Terminal housing	ELxxxx, KLxxxx	ESxxxx, KSxxxx
Wire size width (single core wires)	0.08 ... 2.5 mm ²	0.08 ... 2.5 mm ²
Wire size width (fine-wire conductors)	0.08 ... 2.5 mm ²	0,08 ... 2.5 mm ²
Wire size width (conductors with a wire end sleeve)	0.14 ... 1.5 mm ²	0.14 ... 1.5 mm ²
Wire stripping length	8 ... 9 mm	9 ... 10 mm

High Density Terminals (HD Terminals [▶ 42]) with 16 terminal points

The conductors of the HD Terminals are connected without tools for single-wire conductors using the direct plug-in technique, i.e. after stripping the wire is simply plugged into the terminal point. The cables are released, as usual, using the contact release with the aid of a screwdriver. See the following table for the suitable wire size width.

Terminal housing	High Density Housing
Wire size width (single core wires)	0.08 ... 1.5 mm ²
Wire size width (fine-wire conductors)	0.25 ... 1.5 mm ²
Wire size width (conductors with a wire end sleeve)	0.14 ... 0.75 mm ²
Wire size width (ultrasonically "bonded" conductors)	only 1.5 mm ²
Wire stripping length	8 ... 9 mm

4.3.3 Shielding

i **Shielding**

Encoder, analog sensors and actors should always be connected with shielded, twisted paired wires.

4.4 Installation positions

NOTE

Constraints regarding installation position and operating temperature range

Please refer to the technical data for a terminal to ascertain whether any restrictions regarding the installation position and/or the operating temperature range have been specified. When installing high power dissipation terminals ensure that an adequate spacing is maintained between other components above and below the terminal in order to guarantee adequate ventilation!

Optimum installation position (standard)

The optimum installation position requires the mounting rail to be installed horizontally and the connection surfaces of the EL/KL terminals to face forward (see Fig. "Recommended distances for standard installation position"). The terminals are ventilated from below, which enables optimum cooling of the electronics through convection. "From below" is relative to the acceleration of gravity.

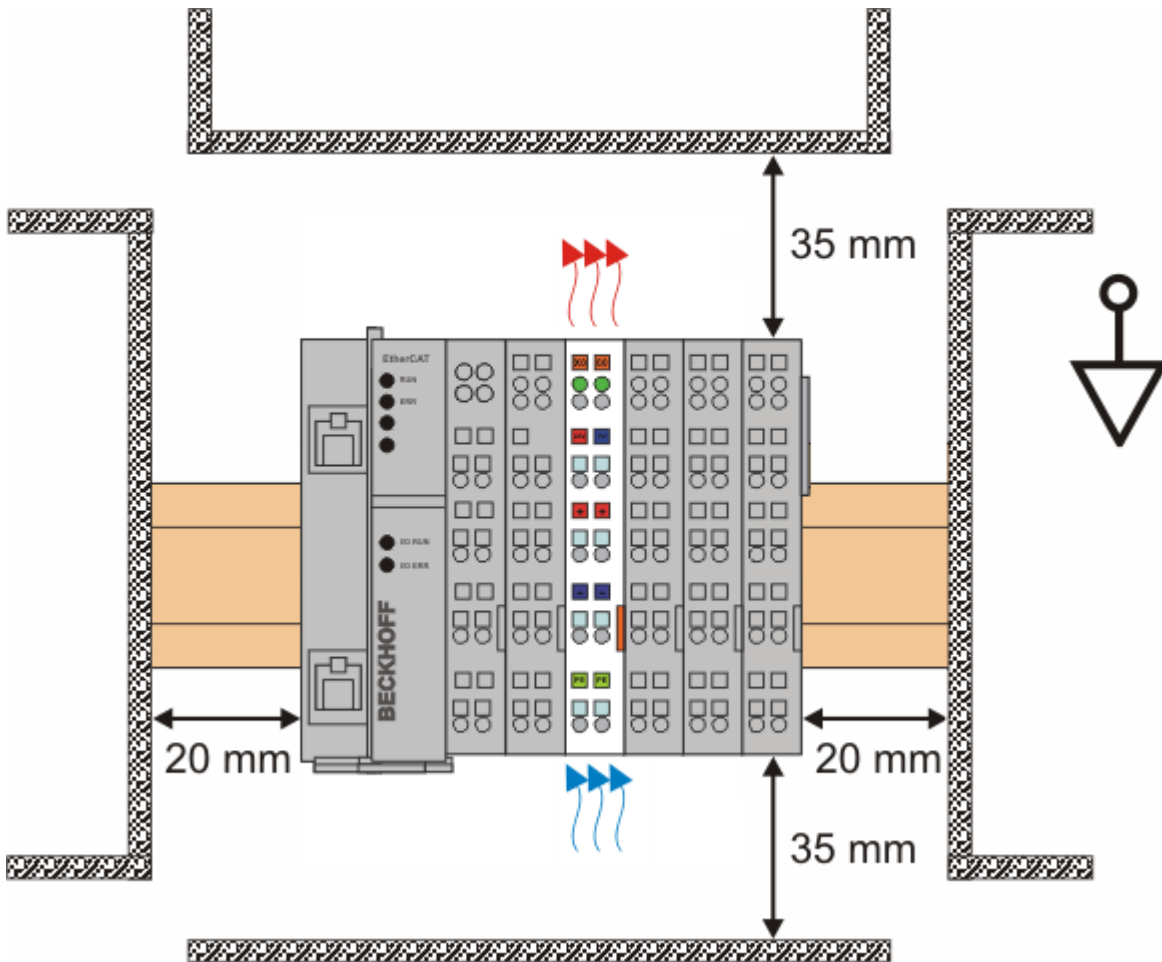

Fig. 32: Recommended distances for standard installation position

Compliance with the distances shown in Fig. “Recommended distances for standard installation position” is recommended.

Other installation positions

All other installation positions are characterized by different spatial arrangement of the mounting rail - see Fig “Other installation positions”.

The minimum distances to ambient specified above also apply to these installation positions.

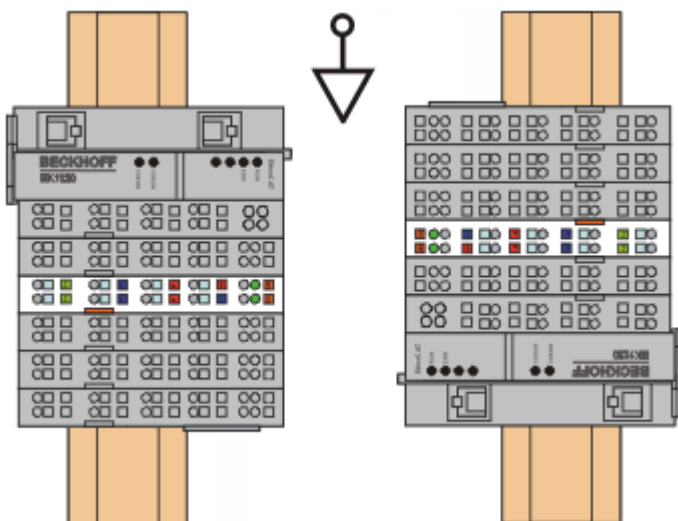

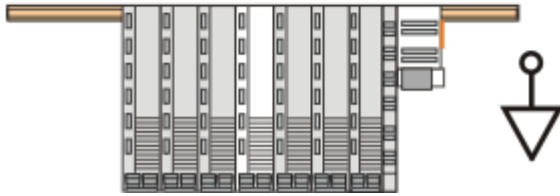
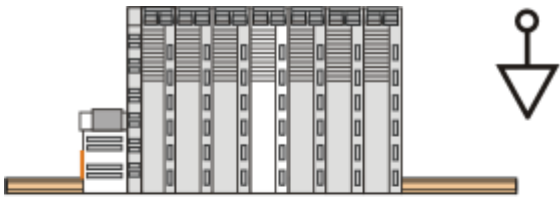

Fig. 33: *Other installation positions*

4.5 Positioning of passive Terminals

i **Hint for positioning of passive terminals in the bus terminal block**

EtherCAT Terminals (ELxxxx / ESxxxx), which do not take an active part in data transfer within the bus terminal block are so called passive terminals. The passive terminals have no current consumption out of the E-Bus.

To ensure an optimal data transfer, you must not directly string together more than 2 passive terminals!

Examples for positioning of passive terminals (highlighted)

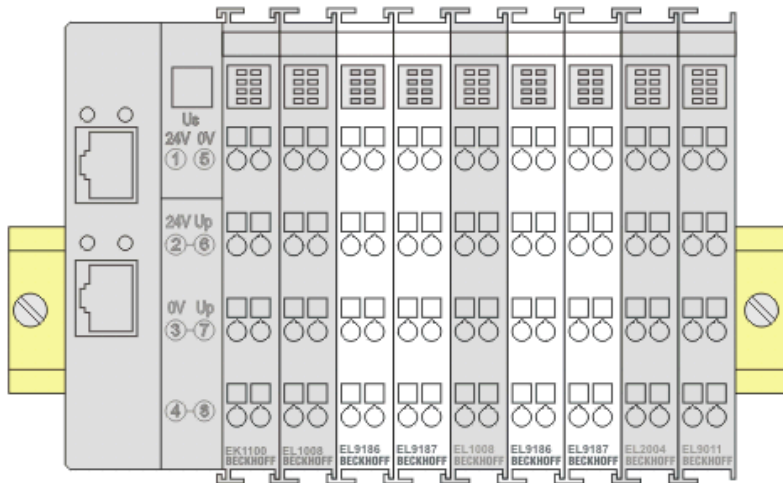

Fig. 34: Correct positioning

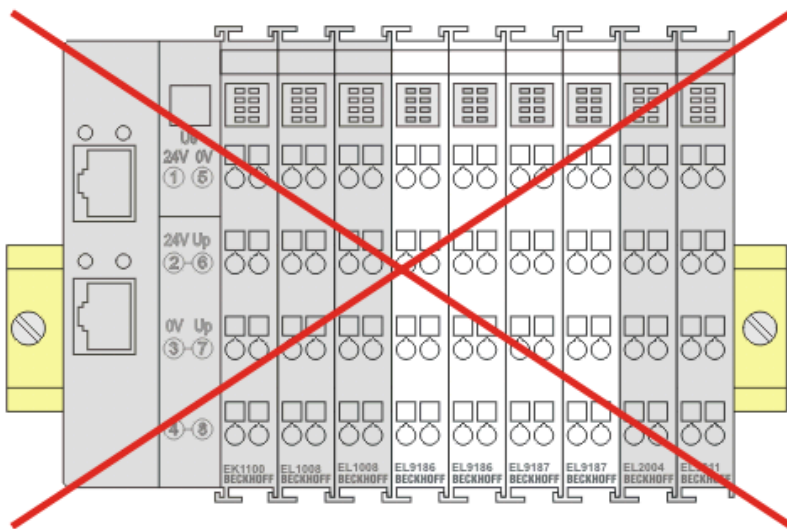



Fig. 35: Incorrect positioning

4.6 UL notice

	<p>Application Beckhoff EtherCAT modules are intended for use with Beckhoff's UL Listed EtherCAT System only.</p>
	<p>Examination For cULus examination, the Beckhoff I/O System has only been investigated for risk of fire and electrical shock (in accordance with UL508 and CSA C22.2 No. 142).</p>

	<p>For devices with Ethernet connectors Not for connection to telecommunication circuits.</p>
---	--

Basic principles

Two UL certificates are met in the Beckhoff EtherCAT product range, depending upon the components:

1. UL certification according to UL508. Devices with this kind of certification are marked by this sign:



2. UL certification according to UL508 with limited power consumption. The current consumed by the device is limited to a max. possible current consumption of 4 A. Devices with this kind of certification are marked by this sign:

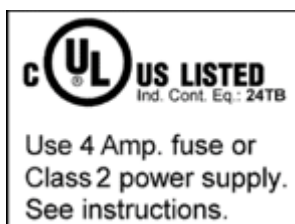

Almost all current EtherCAT products (as at 2010/05) are UL certified without restrictions.

Application

If terminals certified *with restrictions* are used, then the current consumption at 24 V_{DC} must be limited accordingly by means of supply

- from an isolated source protected by a fuse of max. 4 A (according to UL248) or
- from a voltage supply complying with *NEC class 2*.
A voltage source complying with *NEC class 2* may not be connected in series or parallel with another *NEC class 2* compliant voltage supply!

These requirements apply to the supply of all EtherCAT bus couplers, power adaptor terminals, Bus Terminals and their power contacts.

4.7 EL34x3 - LEDs and connection

4.7.1 EL3413-0000



Fig. 36: EL3413-0000 LEDs

LEDs

LED	Color	Meaning	
RUN	green	This LED indicates the terminal's operating state:	
		off	State of the EtherCAT State Machine [► 30]: INIT = initialization of the terminal or
		fast flashing	State of the EtherCAT State Machine [► 30]: BOOTSTRAP = function for firmware updates [► 184] of the terminal
		flashing	State of the EtherCAT State Machine [► 30]: PREOP = function for mailbox communication and different standard-settings set
		single flash	State of the EtherCAT State Machine [► 30]: SAFEOP = verification of the Sync Manager [► 112] channels and the distributed clocks. Outputs remain in safe state.
on	State of the EtherCAT State Machine [► 30]: OP = normal operating state; mailbox and process data communication is possible		
IN Error	red	on	Overcurrent on neutral (Current > 11 A)
IL1 OK	green	on	Current IL1 ok
IL1 Error	red	on	Overcurrent on L1. Current > 110 mA (with 0.1 A measuring range) Current > 1.1 A (with 1 A measuring range) Current > 5.5 A (with 5 A measuring range)
IL2 OK	green	on	Current IL2 ok
IL2 Error	red	on	Overcurrent on L2. Current > 110 mA (with 0.1 A measuring range) Current > 1.1 A (with 1 A measuring range) Current > 5.5 A (with 5 A measuring range)
IL3 OK	green	on	Current IL3 ok
IL3 Error	red	on	Overcurrent on L3. Current > 110 mA (with 0.1 A measuring range) Current > 1.1 A (with 1 A measuring range) Current > 5.5 A (with 5 A measuring range))
ccw	green	on	Counter-clockwise rotating field correctly detected
cw	green	on	Clockwise rotating field correctly detected
L1 OK	green	on	Voltage on L1 and zero crossing detected. Voltage > 5 V (L1-N)
L1 Error	red	on	Over- or undervoltage on L1. Voltage < 5 V or voltage > 415 V (L1-N) No zero crossings detected correctly by L1
L2 OK	green	on	Voltage on L2 and zero crossing detected. Voltage > 5 V (L2-N)
L2 Error	red	on	Over- or undervoltage on L2. Voltage < 5 V or voltage > 415 V (L2-N) No zero crossings detected correctly by L2
L3 OK	green	on	Voltage on L3 and zero crossing detected. Voltage > 5 V (L3-N)
L3 Error	red	on	Over- or undervoltage on L3. Voltage < 5 V or voltage > 415 V (L3-N) No zero crossings detected correctly by L3

Connection

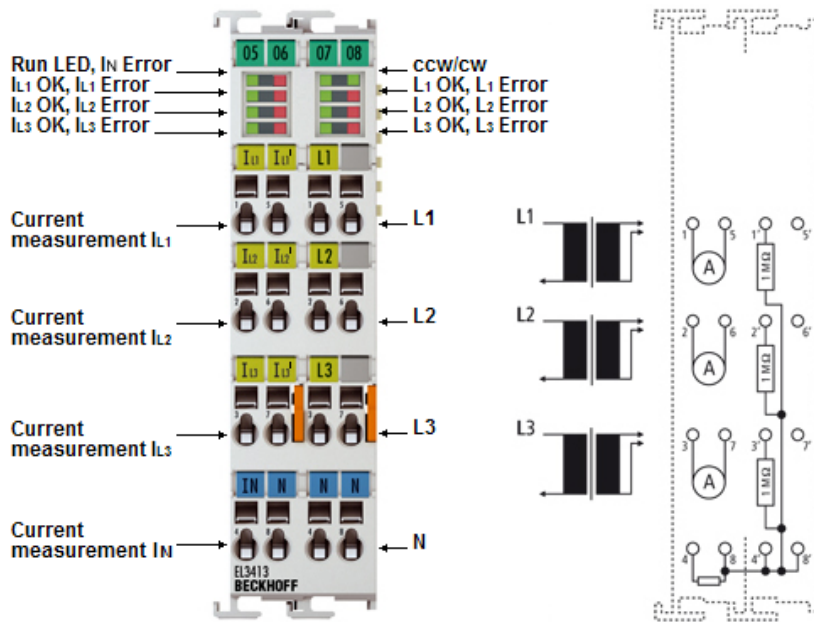

Fig. 37: EL3413-0000 Connection

⚠ WARNING

Do not operate current transformers in no-load mode!

Please note that many manufacturers do not permit their current transformers to be operated in no-load mode! Connect the EL3413 to the secondary windings of the current transformers before using the current transformer!

Terminal point		Description
Name	No.	
IL1	1	Phase L1 current measurement input
IL2	2	Phase L2 current measurement input
IL3	3	Phase L3 current measurement input
IN	4	Neutral conductor current measurement input (star point)
IL1'	5	Phase L1 current measurement output
IL2'	6	Phase L2 current measurement output
IL3'	7	Phase L3 current measurement output
N	8	Neutral conductor

⚠ WARNING

Earthing of the terminal point N when measuring current!

If you do not connect the terminal point N with the neutral conductor of your mains supply (e.g. if the terminal is used purely for current measurements) and use the I_N current measurement channel, terminal point N should be earthed, in order to avoid dangerous overvoltages in the event of a current transformer fault.

Earthing of the N point is not absolutely necessary if only the galvanically isolated current channels are used.

Terminal point		Description
Name	No.	
L1	1'	Phase L1 voltage measurement input
L2	2'	Phase L2 voltage measurement input
L3	3'	Phase L3 voltage measurement input
N	4'	Neutral conductor
	5'	n.c.
	6'	n.c.
	7'	n.c.
N	8'	Neutral conductor

4.7.2 EL3413-0001



Fig. 38: EL3413-0001 LEDs

LEDs

LED	Color	Meaning	
RUN	green	This LED indicates the terminal's operating state:	
		off	State of the <u>EtherCAT State Machine</u> [▶ 30]: INIT = initialization of the terminal or
		fast flashing	State of the <u>EtherCAT State Machine</u> [▶ 30]: BOOTSTRAP = function for <u>firmware updates</u> [▶ 184] of the terminal
		flashing	State of the <u>EtherCAT State Machine</u> [▶ 30]: PREOP = function for mailbox communication and different standard-settings set
		single flash	State of the <u>EtherCAT State Machine</u> [▶ 30]: SAFEOP = verification of the <u>Sync Manager</u> [▶ 112] channels and the distributed clocks. Outputs remain in safe state.
on	State of the <u>EtherCAT State Machine</u> [▶ 30]: OP = normal operating state; mailbox and process data communication is possible		
IN Error	red	on	Overcurrent on neutral (Current > 11 A)
IL1 OK	green	on	Current IL1 ok
IL1 Error	red	on	Overcurrent on L1. Current > 1.1 A (with 1 A measuring range) Current > 5.5 A (with 5 A measuring range)
IL2 OK	green	on	Current IL2 ok
IL2 Error	red	on	Overcurrent on L2. Current > 1.1 A (with 1 A measuring range) Current > 5.5 A (with 5 A measuring range)
IL3 OK	green	on	Current IL3 ok
IL3 Error	red	on	Overcurrent on L3. Current > 1.1 A (with 1 A measuring range) Current > 5.5 A (with 5 A measuring range))
ccw	green	on	Counter-clockwise rotating field correctly detected
cw	green	on	Clockwise rotating field correctly detected
L1 OK	green	on	Voltage on L1 and zero crossing detected. Voltage > 5 V (L1-N)
L1 Error	red	on	Over- or undervoltage on L1. Voltage < 5 V or voltage > 360 V (L1-N) No zero crossings detected correctly by L1
L2 OK	green	on	Voltage on L2 and zero crossing detected. Voltage > 5 V (L2-N)
L2 Error	red	on	Over- or undervoltage on L2. Voltage < 5 V or voltage > 360 V (L2-N) No zero crossings detected correctly by L2
L3 OK	green	on	Voltage on L3 and zero crossing detected. Voltage > 5 V (L3-N)
L3 Error	red	on	Over- or undervoltage on L3. Voltage < 5 V or voltage > 360 V (L3-N) No zero crossings detected correctly by L3

Connection

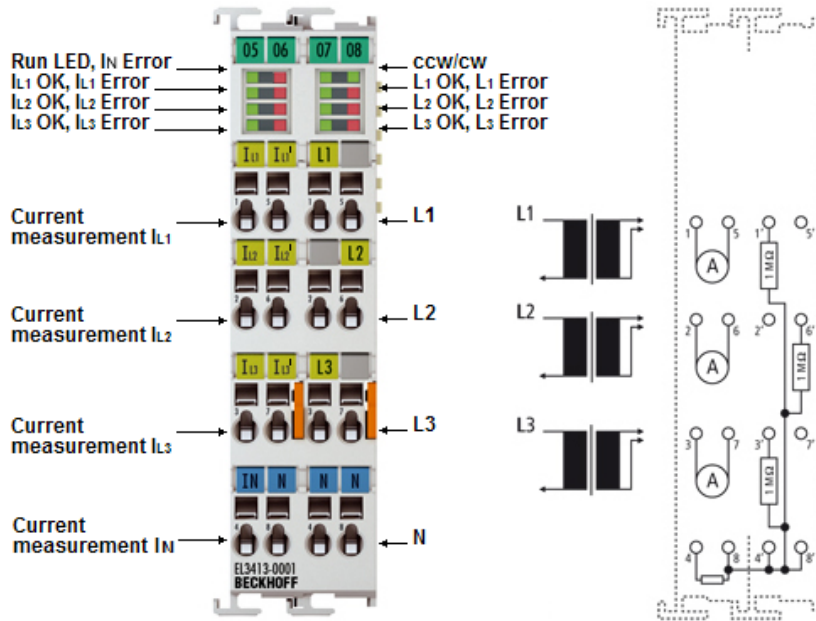

Fig. 39: EL3413-0001 Connection

⚠ WARNING

Do not operate current transformers in no-load mode!

Please note that many manufacturers do not permit their current transformers to be operated in no-load mode! Connect the EL3413 to the secondary windings of the current transformers before using the current transformer!

Terminal point		Description
Name	No.	
IL1	1	Phase L1 current measurement input
IL2	2	Phase L2 current measurement input
IL3	3	Phase L3 current measurement input
IN	4	Neutral conductor current measurement input (star point)
IL1'	5	Phase L1 current measurement output
IL2'	6	Phase L2 current measurement output
IL3'	7	Phase L3 current measurement output
N	8	Neutral conductor

⚠ WARNING

Earthing of the terminal point N when measuring current!

If you do not connect the terminal point N with the neutral conductor of your mains supply (e.g. if the terminal is used purely for current measurements) and use the I_N current measurement channel, terminal point N should be earthed, in order to avoid dangerous overvoltages in the event of a current transformer fault.

Earthing of the N point is not absolutely necessary if only the galvanically isolated current channels are used.

Terminal point		Description
Name	No.	
L1	1'	Phase L1 voltage measurement input
	2'	n.c.
L3	3'	Phase L3 voltage measurement input
N	4'	Neutral conductor
	5'	n.c.
L2	6'	Phase L2 voltage measurement input
	7'	n.c.
N	8'	Neutral conductor

4.7.3 EL3413-0120



Fig. 40: EL3413-0120 LEDs

LEDs

LED	Color	Meaning	
RUN	green	This LED indicates the terminal's operating state:	
		off	State of the EtherCAT State Machine [▶ 30] : INIT = initialization of the terminal or
		fast flashing	State of the EtherCAT State Machine [▶ 30] : BOOTSTRAP = function for firmware updates [▶ 184] of the terminal
		flashing	State of the EtherCAT State Machine [▶ 30] : PREOP = function for mailbox communication and different standard-settings set
		single flash	State of the EtherCAT State Machine [▶ 30] : SAFEOP = verification of the Sync Manager [▶ 112] channels and the distributed clocks. Outputs remain in safe state.
on	State of the EtherCAT State Machine [▶ 30] : OP = normal operating state; mailbox and process data communication is possible		
IN Error	red	on	Overcurrent on neutral (Current > 11 A)
IL1 OK	green	on	Current IL1 ok
IL1 Error	red	on	Overcurrent on L1. Current > 110 mA (with 0.1 A measuring range) Current > 1.1 A (with 1 A measuring range) Current > 5.5 A (with 5 A measuring range)
IL2 OK	green	on	Current IL2 ok
IL2 Error	red	on	Overcurrent on L2. Current > 110 mA (with 0.1 A measuring range) Current > 1.1 A (with 1 A measuring range) Current > 5.5 A (with 5 A measuring range)
IL3 OK	green	on	Current IL3 ok
IL3 Error	red	on	Overcurrent on L3. Current > 110 mA (with 0.1 A measuring range) Current > 1.1 A (with 1 A measuring range) Current > 5.5 A (with 5 A measuring range)
ccw	green	on	Counter-clockwise rotating field correctly detected
cw	green	on	Clockwise rotating field correctly detected
L1 OK	green	on	Voltage on L1 and zero crossing detected. Voltage > 5 V (L1-N)
L1 Error	red	on	Over- or undervoltage on L1. Voltage < 5 V or voltage > 130 V (L1-N) No zero crossings detected correctly by L1
L2 OK	green	on	Voltage on L2 and zero crossing detected. Voltage > 5 V (L2-N)
L2 Error	red	on	Over- or undervoltage on L2. Voltage < 5 V or voltage > 130 V (L2-N) No zero crossings detected correctly by L2
L3 OK	green	on	Voltage on L3 and zero crossing detected. Voltage > 5 V (L3-N)
L3 Error	red	on	Over- or undervoltage on L3. Voltage < 5 V or voltage > 130 V (L3-N) No zero crossings detected correctly by L3

Connection

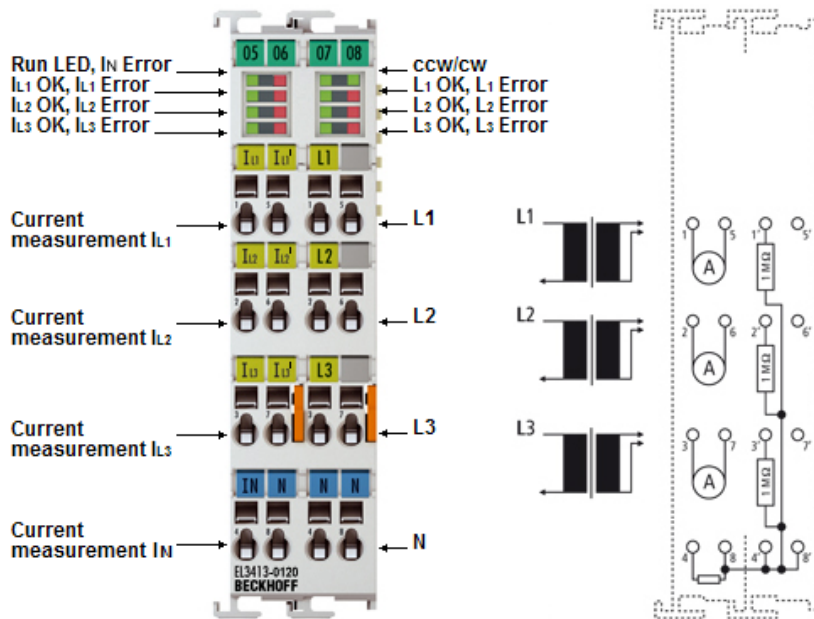

Fig. 41: EL3413-0120 Connection

⚠ WARNING

Do not operate current transformers in no-load mode!

Please note that many manufacturers do not permit their current transformers to be operated in no-load mode! Connect the EL3413 to the secondary windings of the current transformers before using the current transformer!

Terminal point		Description
Name	No.	
IL1	1	Phase L1 current measurement input
IL2	2	Phase L2 current measurement input
IL3	3	Phase L3 current measurement input
IN	4	Neutral conductor current measurement input (star point)
IL1'	5	Phase L1 current measurement output
IL2'	6	Phase L2 current measurement output
IL3'	7	Phase L3 current measurement output
N	8	Neutral conductor

⚠ WARNING

Earthing of the terminal point N when measuring current!

If you do not connect the terminal point N with the neutral conductor of your mains supply (e.g. if the terminal is used purely for current measurements) and use the I_N current measurement channel, terminal point N should be earthed, in order to avoid dangerous overvoltages in the event of a current transformer fault.

Earthing of the N point is not absolutely necessary if only the galvanically isolated current channels are used.

Terminal point		Description
Name	No.	
L1	1'	Phase L1 voltage measurement input
L2	2'	Phase L2 voltage measurement input
L3	3'	Phase L3 voltage measurement input
N	4'	Neutral conductor
	5'	n.c.
	6'	n.c.
	7'	n.c.
N	8'	Neutral conductor

4.7.4 EL3433-0000



Fig. 42: EL3433-0000 LEDs

LEDs

LED	Color	Meaning	
RUN	green	This LED indicates the terminal's operating state:	
		off	State of the EtherCAT State Machine [▶ 30] : INIT = initialization of the terminal or
		fast flashing	State of the EtherCAT State Machine [▶ 30] : BOOTSTRAP = function for firmware updates [▶ 184] of the terminal
		flashing	State of the EtherCAT State Machine [▶ 30] : PREOP = function for mailbox communication and different standard-settings set
		single flash	State of the EtherCAT State Machine [▶ 30] : SAFEOP = verification of the Sync Manager [▶ 112] channels and the distributed clocks. Outputs remain in safe state.
		on	State of the EtherCAT State Machine [▶ 30] : OP = normal operating state; mailbox and process data communication is possible
IN Error	red	on	Overcurrent on neutral (current > 11 A)
IL1 OK	green	on	Current IL1 ok
IL1 Error	red	on	Overcurrent on L1. Current > 220 mA (with 200 mA measuring range) Current > 2.2 A (with 2 A measuring range) Current > 11 A (with 10 A measuring range)
IL2 OK	green	on	Current IL2 ok
IL2 Error	red	on	Overcurrent on L2. Current > 220 mA (with 200 mA measuring range) Current > 2.2 A (with 2 A measuring range) Current > 11 A (with 10 A measuring range)
IL3 OK	green	on	Current IL3 ok
IL3 Error	red	on	Overcurrent on L3. Current > 220 mA (with 200 mA measuring range) Current > 2.2 A (with 2 A measuring range) Current > 11 A (with 10 A measuring range)
ccw	green	on	Counter-clockwise rotating field correctly detected
cw	green	on	Clockwise rotating field correctly detected
L1 OK	green	on	Voltage on L1 and zero crossing detected. Voltage > 5 V (L1-N)
L1 Error	red	on	Over- or undervoltage on L1. Voltage < 5 V or voltage > 288 V (L1-N) No zero crossings detected correctly by L1
L2 OK	green	on	Voltage on L2 and zero crossing detected. Voltage > 5 V (L2-N)
L2 Error	red	on	Over- or undervoltage on L2. Voltage < 5 V or voltage > 288 V (L2-N) No zero crossings detected correctly by L2
L3 OK	green	on	Voltage on L3 and zero crossing detected. Voltage > 5 V (L3-N)
L3 Error	red	on	Over- or undervoltage on L3. Voltage < 5 V or voltage > 288 V (L3-N) No zero crossings detected correctly by L3

Connection

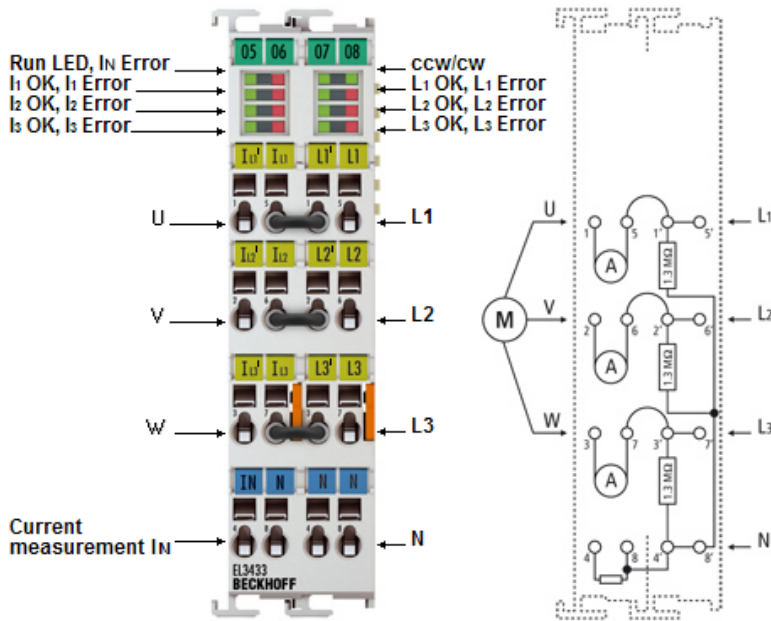

Fig. 43: EL3433-0000 Connection

⚠ WARNING

Do not operate current transformers in no-load mode!

Please note that many manufacturers do not permit their current transformers to be operated in no-load mode! Connect the EL3413 to the secondary windings of the current transformers before using the current transformer!

Terminal point		Description
Name	No.	
IL1' (U)	1	Phase L1 output
IL2' (V)	2	Phase L2 output
IL3' (W)	3	Phase L3 output
IN	4	Neutral conductor current measurement input (star point)
IL1	5	Phase L1 current measurement input
IL2	6	Phase L2 current measurement input
IL3	7	Phase L3 current measurement input
N	8	Neutral conductor

⚠ WARNING

Earthing of the terminal point N when measuring current!

If you do not connect the terminal point N with the neutral conductor of your mains supply (e.g. if the terminal is used purely for current measurements) and use the I_N current measurement channel, terminal point N should be earthed, in order to avoid dangerous overvoltages in the event of a current transformer fault.

Earthing of the N point is not absolutely necessary if only the galvanically isolated current channels are used.

Terminal point		Description
Name	No.	
L1'	1'	Phase L1 voltage measurement output
L2'	2'	Phase L2 voltage measurement output
L3'	3'	Phase L3 voltage measurement output
N	4'	Neutral conductor
L1	5'	Phase L1 voltage measurement input
L2	6'	Phase L2 voltage measurement input
L3	7'	Phase L3 voltage measurement input
N	8'	Neutral conductor

5 Commissioning

5.1 TwinCAT Quick Start

TwinCAT is a development environment for real-time control including multi-PLC system, NC axis control, programming and operation. The whole system is mapped through this environment and enables access to a programming environment (including compilation) for the controller. Individual digital or analog inputs or outputs can also be read or written directly, in order to verify their functionality, for example.

For further information please refer to <http://infosys.beckhoff.com>:

- **EtherCAT Systemmanual:**
Fieldbus Components → EtherCAT Terminals → EtherCAT System Documentation → Setup in the TwinCAT System Manager
- **TwinCAT 2** → TwinCAT System Manager → I/O - Configuration
- In particular, TwinCAT driver installation:
Fieldbus components → Fieldbus Cards and Switches → FC900x – PCI Cards for Ethernet → Installation

Devices contain the terminals for the actual configuration. All configuration data can be entered directly via editor functions (offline) or via the "Scan" function (online):

- **"offline"**: The configuration can be customized by adding and positioning individual components. These can be selected from a directory and configured.
 - The procedure for offline mode can be found under <http://infosys.beckhoff.com>:
TwinCAT 2 → TwinCAT System Manager → IO - Configuration → Adding an I/O Device
- **"online"**: The existing hardware configuration is read
 - See also <http://infosys.beckhoff.com>:
Fieldbus components → Fieldbus cards and switches → FC900x – PCI Cards for Ethernet → Installation → Searching for devices

The following relationship is envisaged from user PC to the individual control elements:

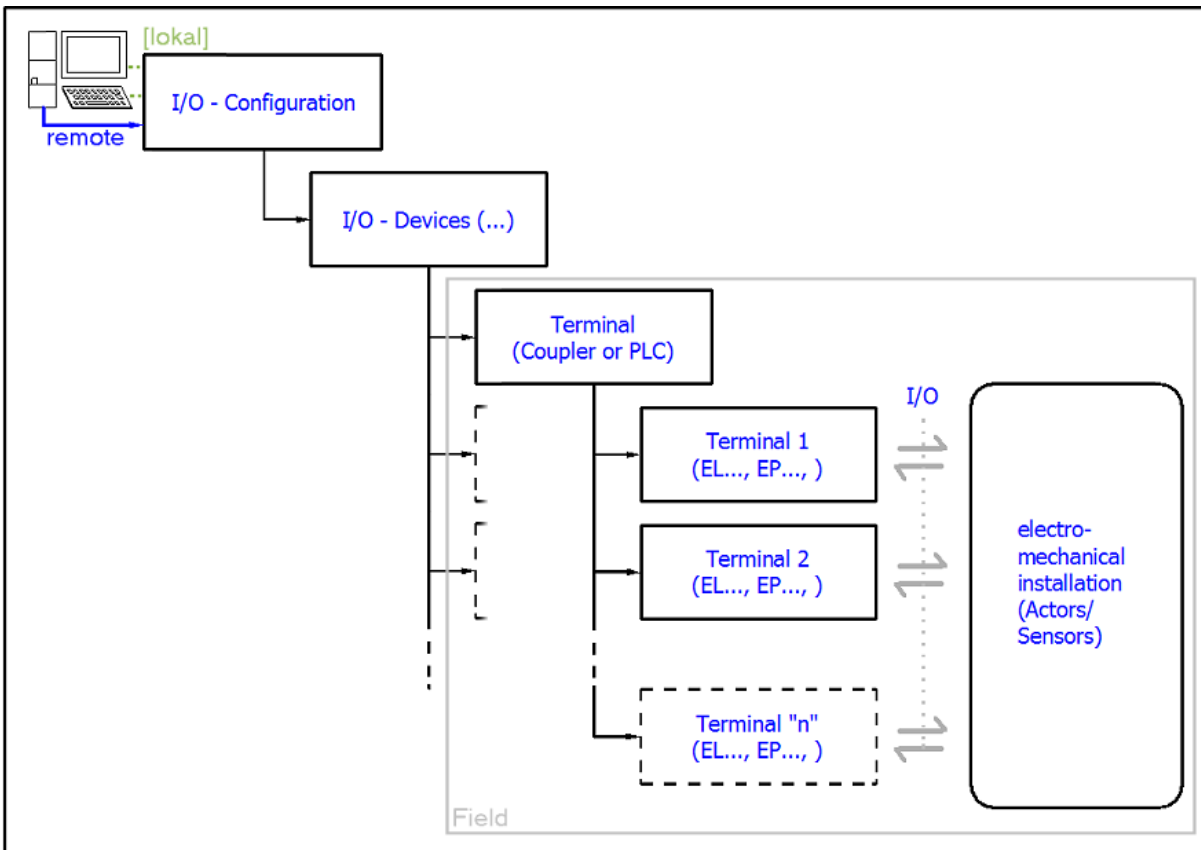

Fig. 44: Relationship between user side (commissioning) and installation

The user inserting of certain components (I/O device, terminal, box...) is the same in TwinCAT 2 and TwinCAT 3. The descriptions below relate to the online procedure.

Sample configuration (actual configuration)

Based on the following sample configuration, the subsequent subsections describe the procedure for TwinCAT 2 and TwinCAT 3:

- Control system (PLC) **CX2040** including **CX2100-0004** power supply unit
- Connected to the CX2040 on the right (E-bus):
EL1004 (4-channel analog input terminal -10...+10 V)
- Linked via the X001 port (RJ-45): **EK1100** EtherCAT Coupler
- Connected to the EK1100 EtherCAT coupler on the right (E-bus):
EL2008 (8-channel digital output terminal 24 V DC; 0.5 A)
- (Optional via X000: a link to an external PC for the user interface)

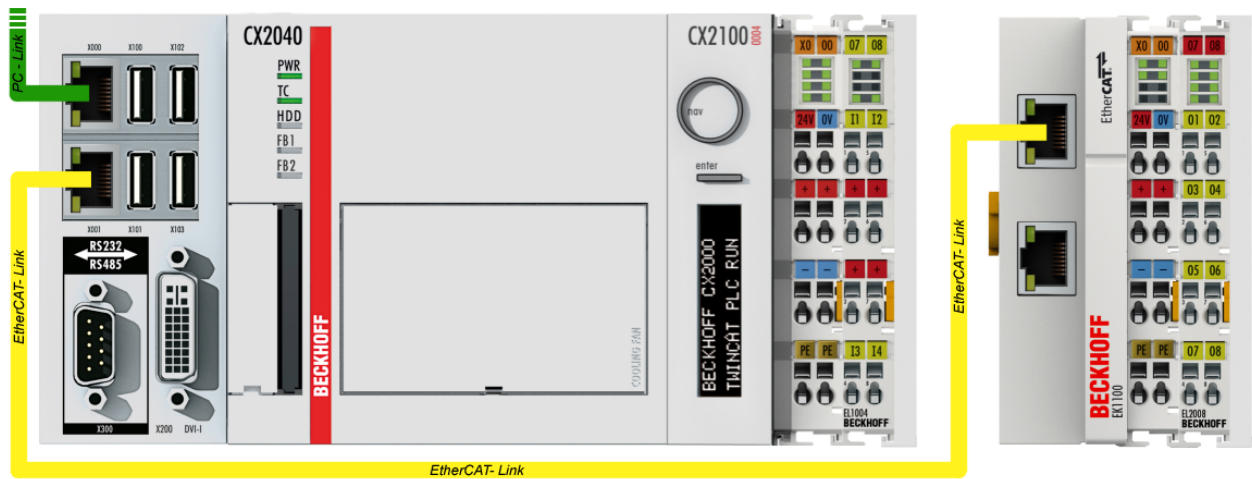

Fig. 45: Control configuration with Embedded PC, input (EL1004) and output (EL2008)

Note that all combinations of a configuration are possible; for example, the EL1004 terminal could also be connected after the coupler, or the EL2008 terminal could additionally be connected to the CX2040 on the right, in which case the EK1100 coupler wouldn't be necessary.

5.1.1 TwinCAT 2

Startup

TwinCAT basically uses two user interfaces: the TwinCAT System Manager for communication with the electromechanical components and TwinCAT PLC Control for the development and compilation of a controller. The starting point is the TwinCAT System Manager.

After successful installation of the TwinCAT system on the PC to be used for development, the TwinCAT 2 System Manager displays the following user interface after startup:

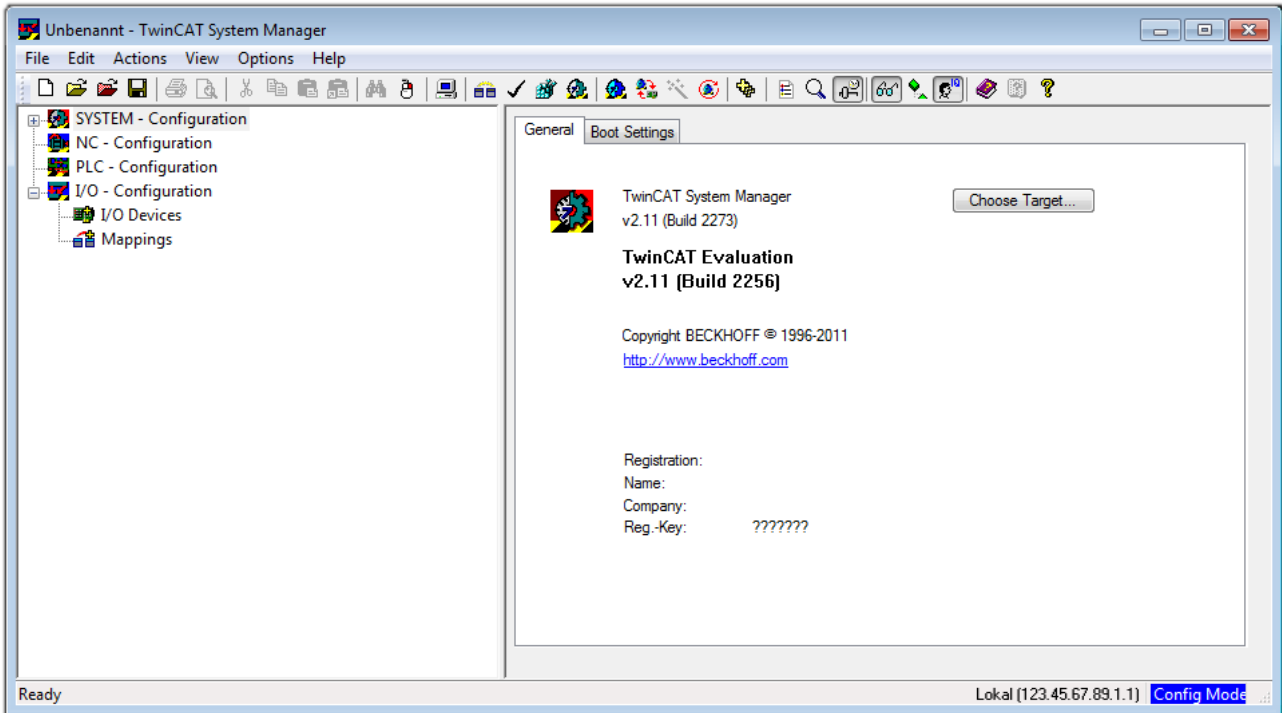



Fig. 46: Initial TwinCAT 2 user interface

Generally, TwinCAT can be used in local or remote mode. Once the TwinCAT system including the user interface (standard) is installed on the respective PLC, TwinCAT can be used in local mode and thereby the next step is "Insert Device [▶ 67]".

If the intention is to address the TwinCAT runtime environment installed on a PLC as development environment remotely from another system, the target system must be made known first. In the menu under

"Actions" → "Choose Target System...", via the symbol "  " or the "F8" key, open the following window:

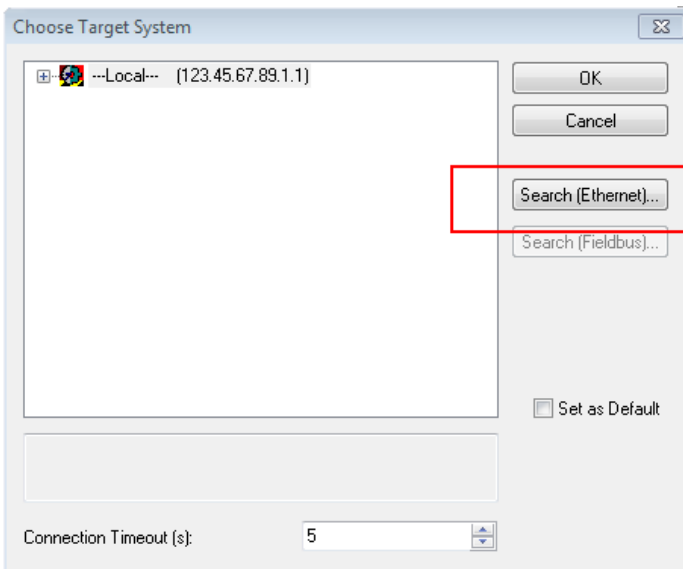

Fig. 47: Selection of the target system

Use "Search (Ethernet)..." to enter the target system. Thus a next dialog opens to either:

- enter the known computer name after "Enter Host Name / IP:" (as shown in red)
- perform a "Broadcast Search" (if the exact computer name is not known)
- enter the known computer IP or AmsNetID.

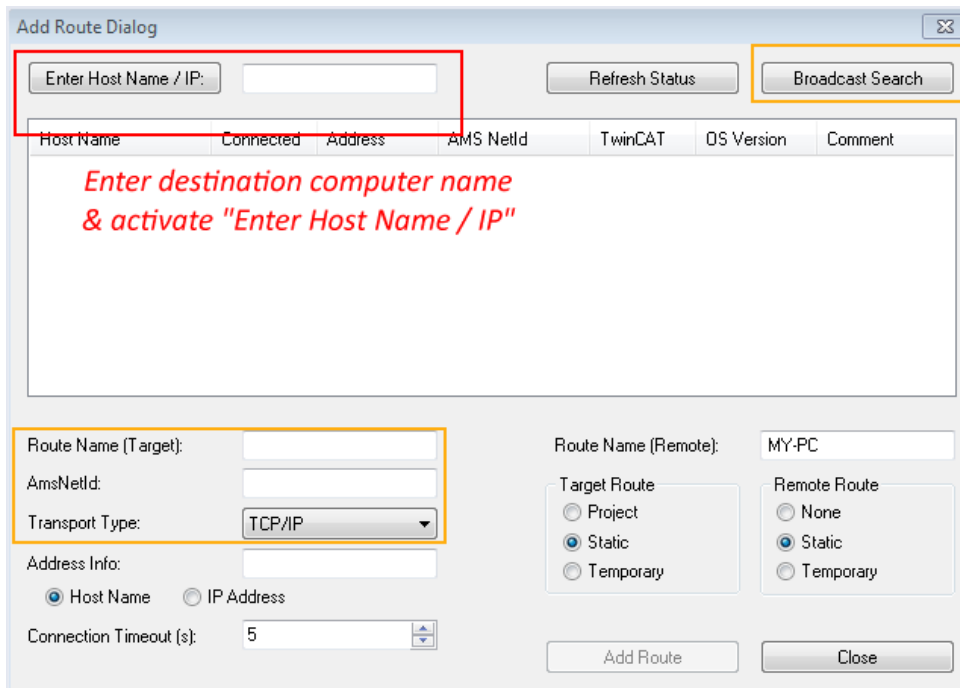
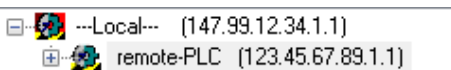

Fig. 48: Specify the PLC for access by the TwinCAT System Manager: selection of the target system



Once the target system has been entered, it is available for selection as follows (a password may have to be entered):



After confirmation with "OK" the target system can be accessed via the System Manager.

Adding devices

In the configuration tree of the TwinCAT 2 System Manager user interface on the left, select "I/O Devices" and then right-click to open a context menu and select "Scan Devices...", or start the action in the menu bar

via . The TwinCAT System Manager may first have to be set to "Config mode" via  or via menu "Actions" → "Set/Reset TwinCAT to Config Mode..." (Shift + F4).

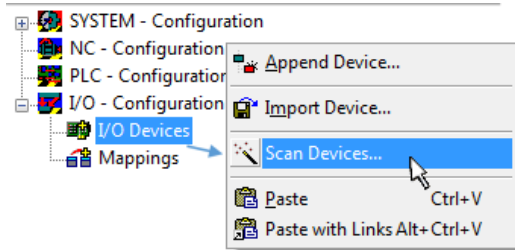

Fig. 49: Select "Scan Devices..."

Confirm the warning message, which follows, and select "EtherCAT" in the dialog:

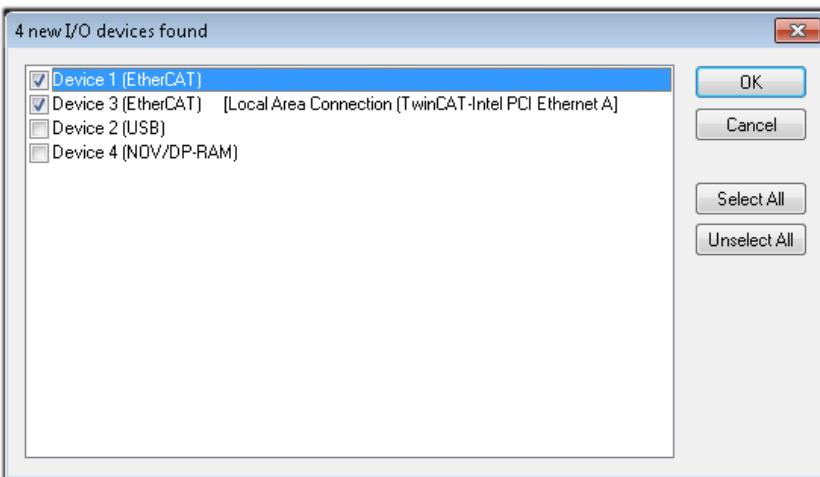

Fig. 50: Automatic detection of I/O devices: selection the devices to be integrated

Confirm the message "Find new boxes", in order to determine the terminals connected to the devices. "Free Run" enables manipulation of input and output values in "Config mode" and should also be acknowledged.

Based on the [sample configuration](#) [▶ 63] described at the beginning of this section, the result is as follows:

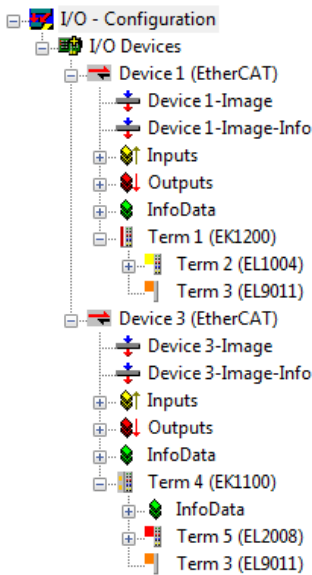

Fig. 51: Mapping of the configuration in the TwinCAT 2 System Manager

The whole process consists of two stages, which may be performed separately (first determine the devices, then determine the connected elements such as boxes, terminals, etc.). A scan can also be initiated by selecting "Device ..." from the context menu, which then reads the elements present in the configuration below:

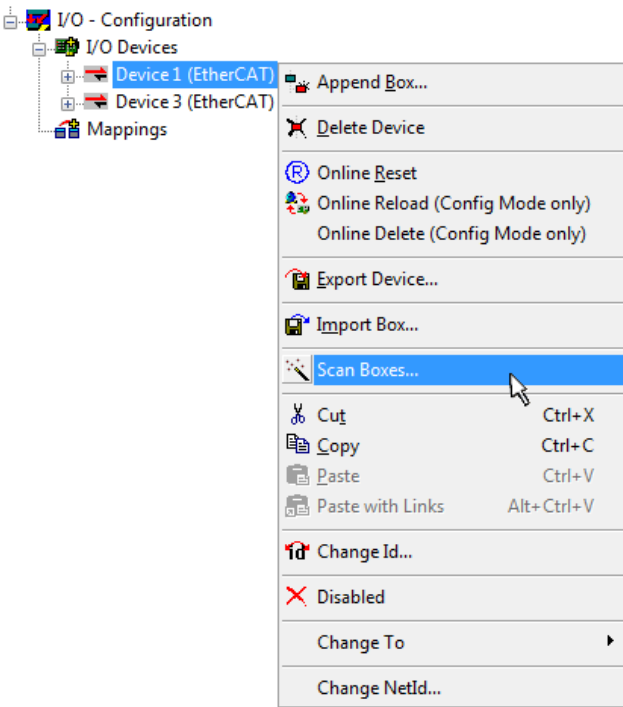

Fig. 52: Reading of individual terminals connected to a device

This functionality is useful if the actual configuration is modified at short notice.

Programming and integrating the PLC

TwinCAT PLC Control is the development environment for the creation of the controller in different program environments: TwinCAT PLC Control supports all languages described in IEC 61131-3. There are two text-based languages and three graphical languages.

- **Text-based languages**
 - Instruction List (IL)

- Structured Text (ST)
- **Graphical languages**
 - Function Block Diagram (FBD)
 - Ladder Diagram (LD)
 - The Continuous Function Chart Editor (CFC)
 - Sequential Function Chart (SFC)

The following section refers to Structured Text (ST).

After starting TwinCAT PLC Control, the following user interface is shown for an initial project:

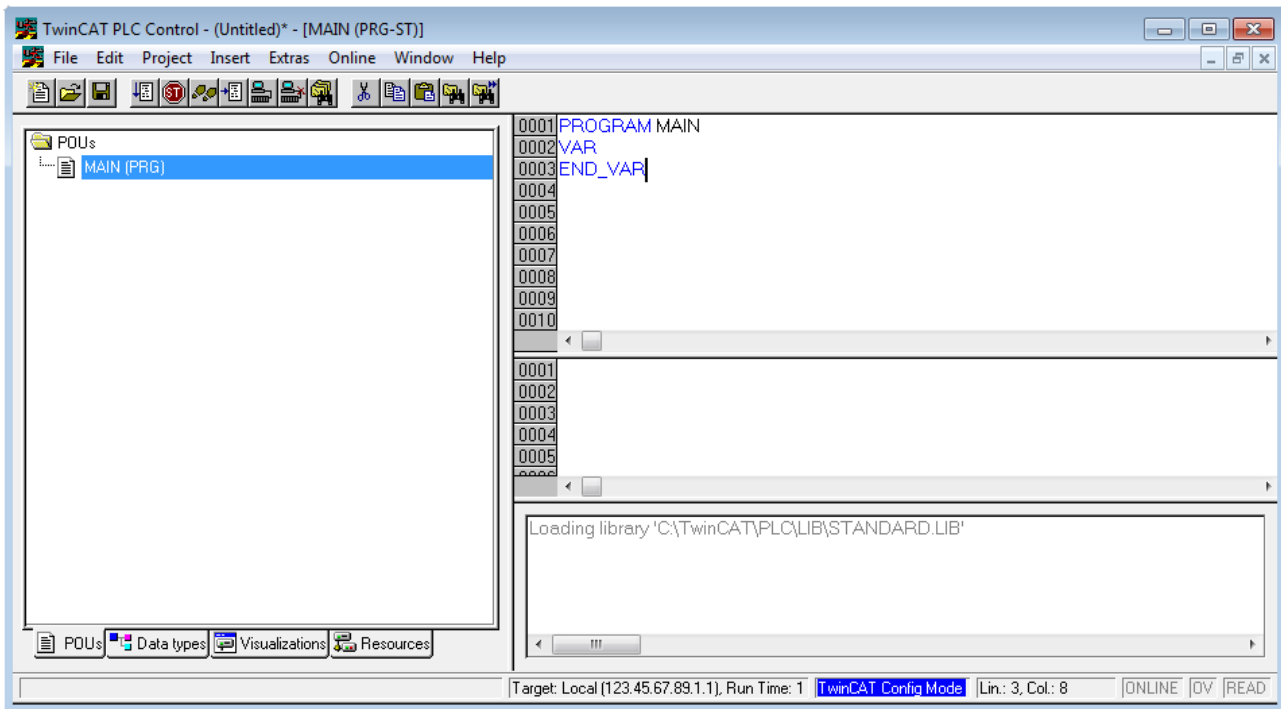

Fig. 53: TwinCAT PLC Control after startup

Sample variables and a sample program have been created and stored under the name "PLC_example.pro":

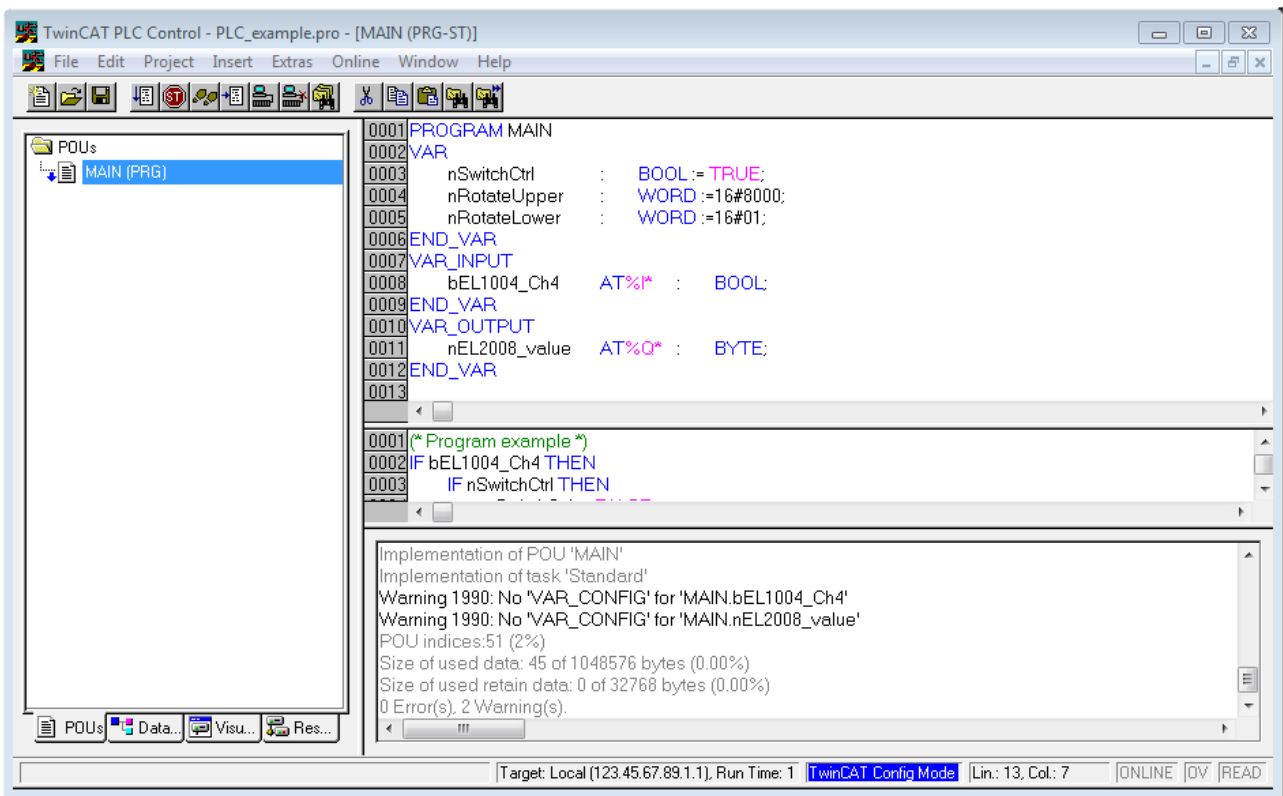

Fig. 54: Sample program with variables after a compile process (without variable integration)

Warning 1990 (missing "VAR_CONFIG") after a compile process indicates that the variables defined as external (with the ID "AT%I*" or "AT%Q*") have not been assigned. After successful compilation, TwinCAT PLC Control creates a "*.tpy" file in the directory in which the project was stored. This file (*.tpy) contains variable assignments and is not known to the System Manager, hence the warning. Once the System Manager has been notified, the warning no longer appears.

First, integrate the TwinCAT PLC Control project in the **System Manager** via the context menu of the PLC configuration; right-click and select "Append PLC Project...":

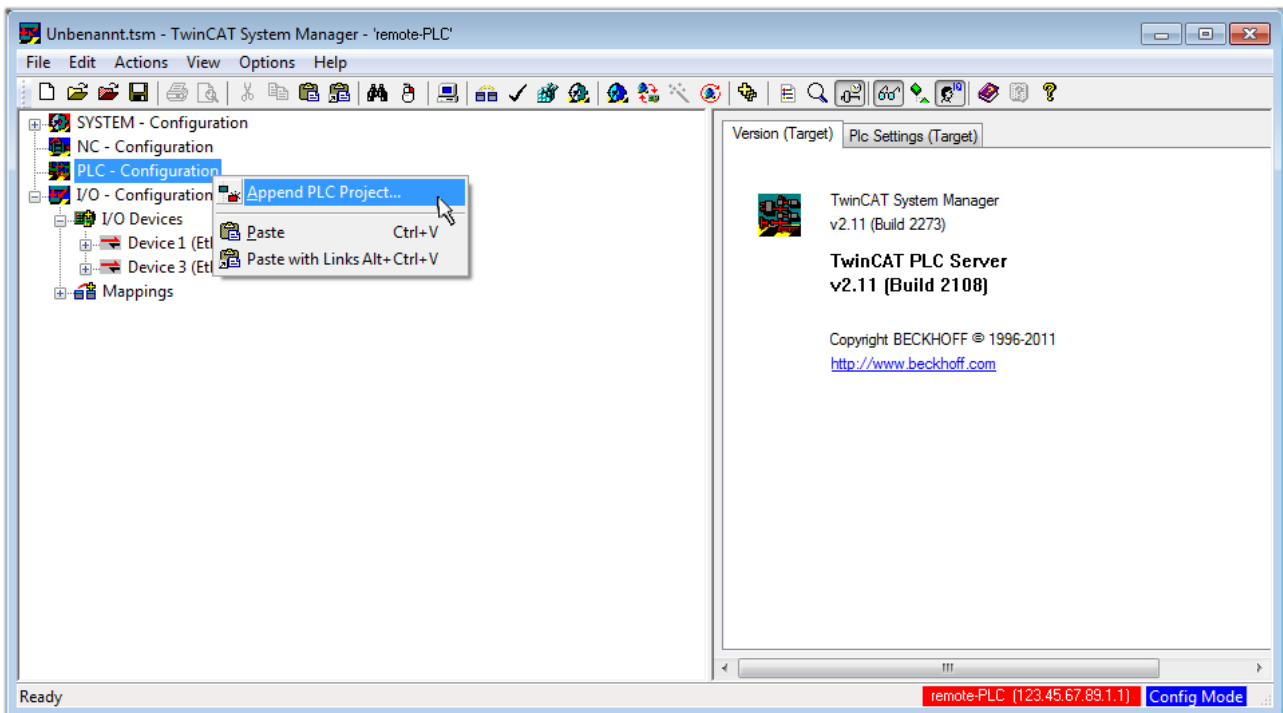

Fig. 55: Appending the TwinCAT PLC Control project

Select the PLC configuration "PLC_example.tpy" in the browser window that opens. The project including the two variables identified with "AT" are then integrated in the configuration tree of the System Manager:

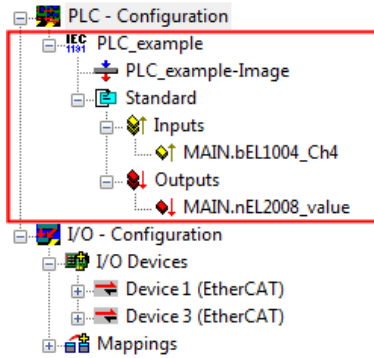

Fig. 56: PLC project integrated in the PLC configuration of the System Manager

The two variables "bEL1004_Ch4" and "nEL2008_value" can now be assigned to certain process objects of the I/O configuration.

Assigning variables

Open a window for selecting a suitable process object (PDO) via the context menu of a variable of the integrated project "PLC_example" and via "Modify Link..." "Standard":

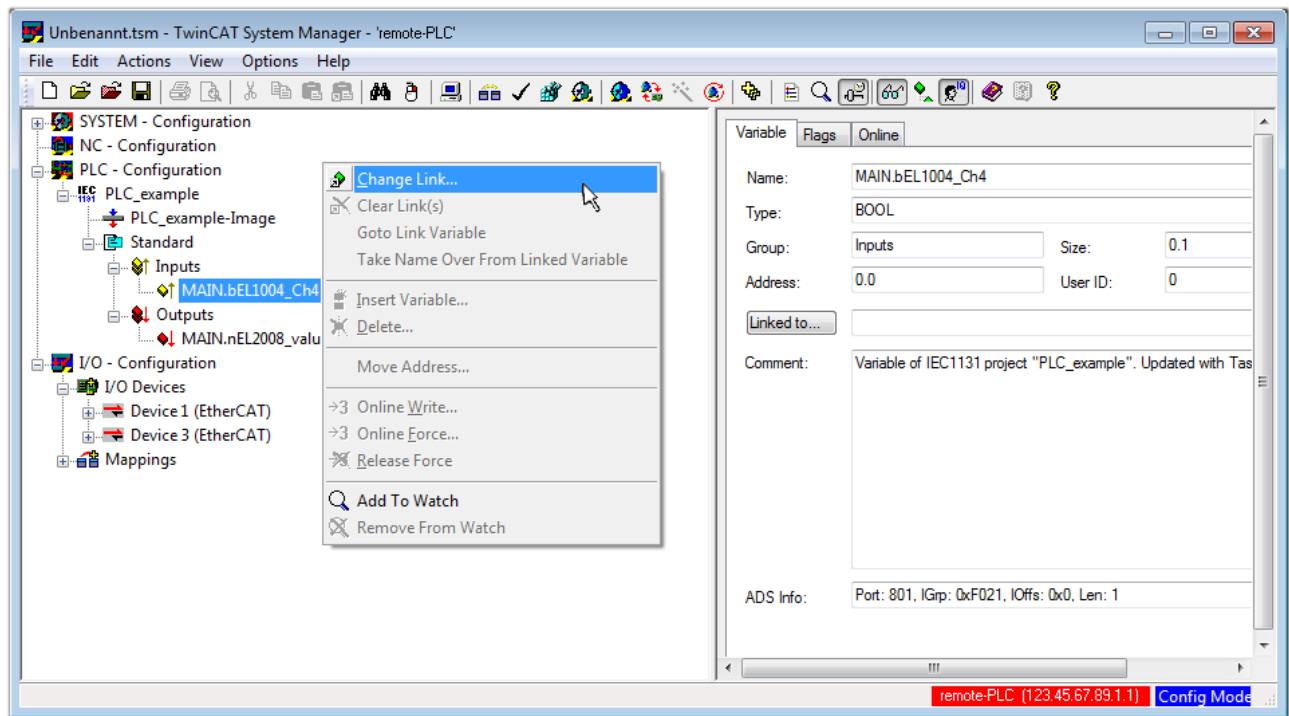

Fig. 57: Creating the links between PLC variables and process objects

In the window that opens, the process object for the variable "bEL1004_Ch4" of type BOOL can be selected from the PLC configuration tree:

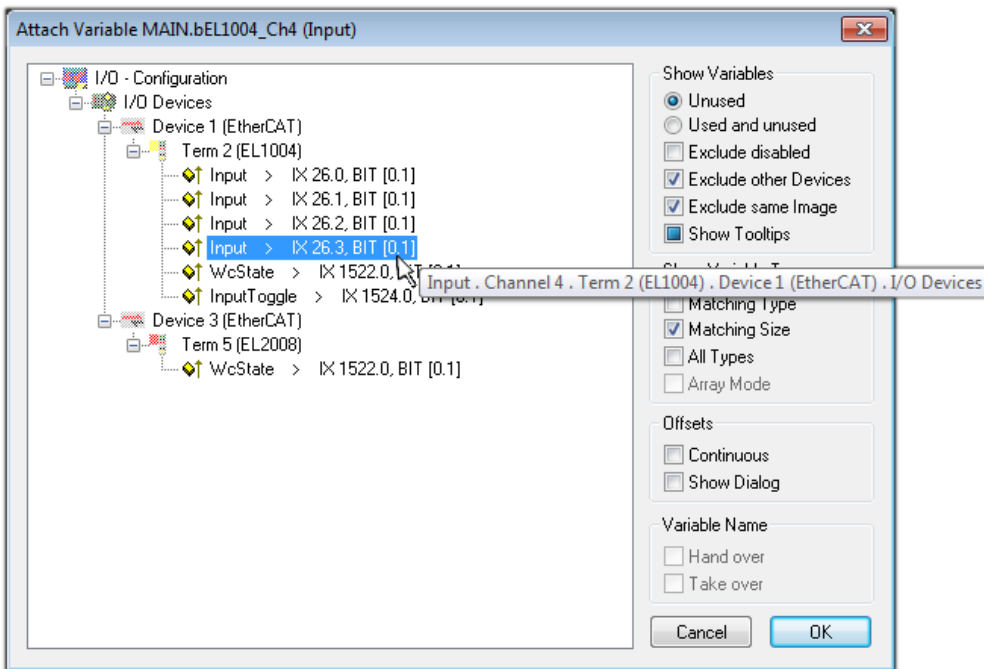

Fig. 58: Selecting PDO of type BOOL

According to the default setting, certain PDO objects are now available for selection. In this sample the input of channel 4 of the EL1004 terminal is selected for linking. In contrast, the checkbox "All types" must be ticked for creating the link for the output variables, in order to allocate a set of eight separate output bits to a byte variable. The following diagram shows the whole process:

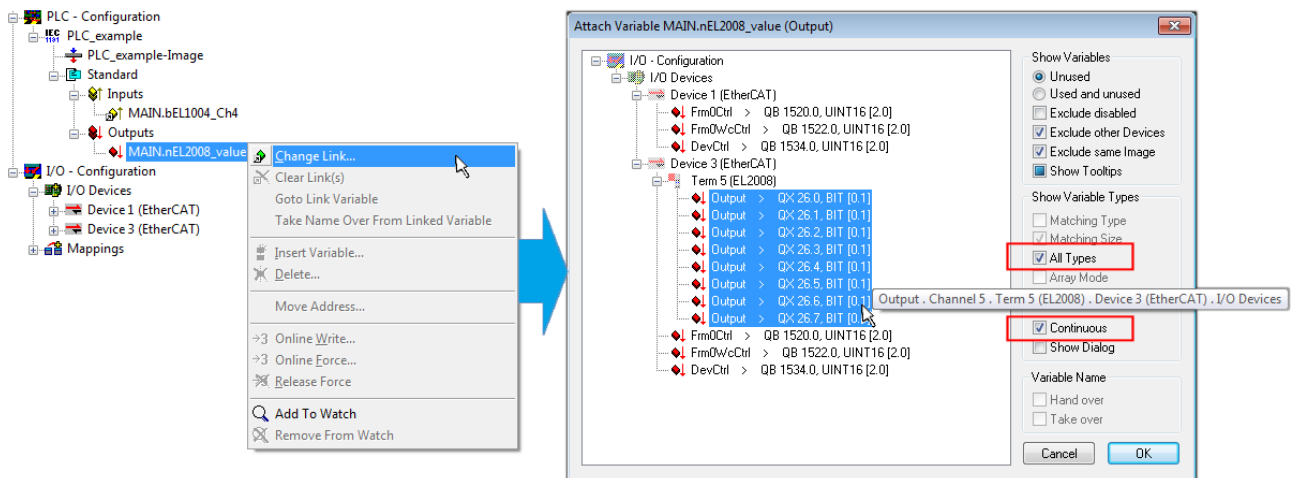



Fig. 59: Selecting several PDOs simultaneously: activate "Continuous" and "All types"

Note that the "Continuous" checkbox was also activated. This is designed to allocate the bits contained in the byte of the variable "nEL2008_value" sequentially to all eight selected output bits of the EL2008 terminal. In this way it is possible to subsequently address all eight outputs of the terminal in the program with a byte corresponding to bit 0 for channel 1 to bit 7 for channel 8 of the PLC. A special symbol () at the yellow or red object of the variable indicates that a link exists. The links can also be checked by selecting a "Goto Link Variable" from the context menu of a variable. The object opposite, in this case the PDO, is automatically selected:

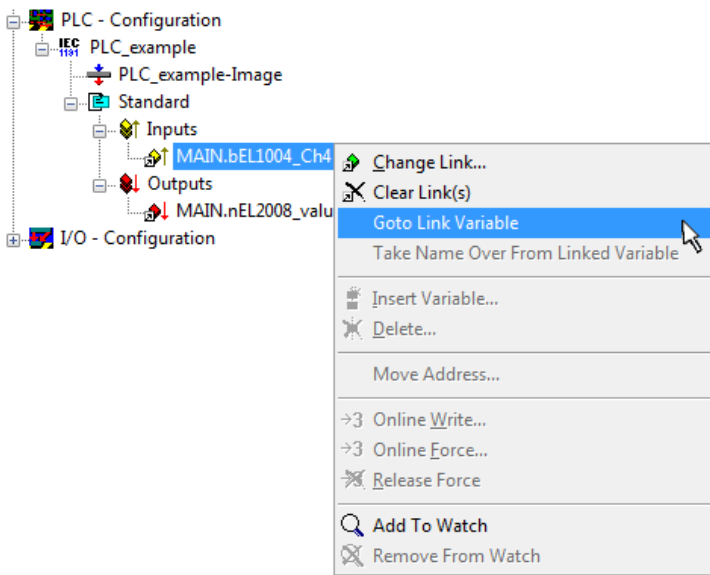

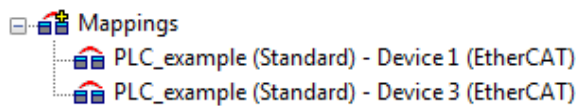

Fig. 60: Application of a "Goto Link" variable, using "MAIN.bEL1004_Ch4" as a sample

The process of assigning variables to the PDO is completed via the menu selection "Actions" → "Generate Mappings", key Ctrl+M or by clicking on the symbol  in the menu.

This can be visualized in the configuration:



The process of creating links can also take place in the opposite direction, i.e. starting with individual PDOs to variable. However, in this example it would then not be possible to select all output bits for the EL2008, since the terminal only makes individual digital outputs available. If a terminal has a byte, word, integer or similar PDO, it is possible to allocate this a set of bit-standardised variables (type "BOOL"). Here, too, a "Goto Link Variable" from the context menu of a PDO can be executed in the other direction, so that the respective PLC instance can then be selected.

Activation of the configuration

The allocation of PDO to PLC variables has now established the connection from the controller to the inputs and outputs of the terminals. The configuration can now be activated. First, the configuration can be verified

via  (or via "Actions" → "Check Configuration"). If no error is present, the configuration can be

activated via  (or via "Actions" → "Activate Configuration...") to transfer the System Manager settings to the runtime system. Confirm the messages "Old configurations are overwritten!" and "Restart TwinCAT system in Run mode" with "OK".

A few seconds later the real-time status **RTime 0%** is displayed at the bottom right in the System Manager. The PLC system can then be started as described below.

Starting the controller

Starting from a remote system, the PLC control has to be linked with the Embedded PC over Ethernet via "Online" → "Choose Run-Time System...":

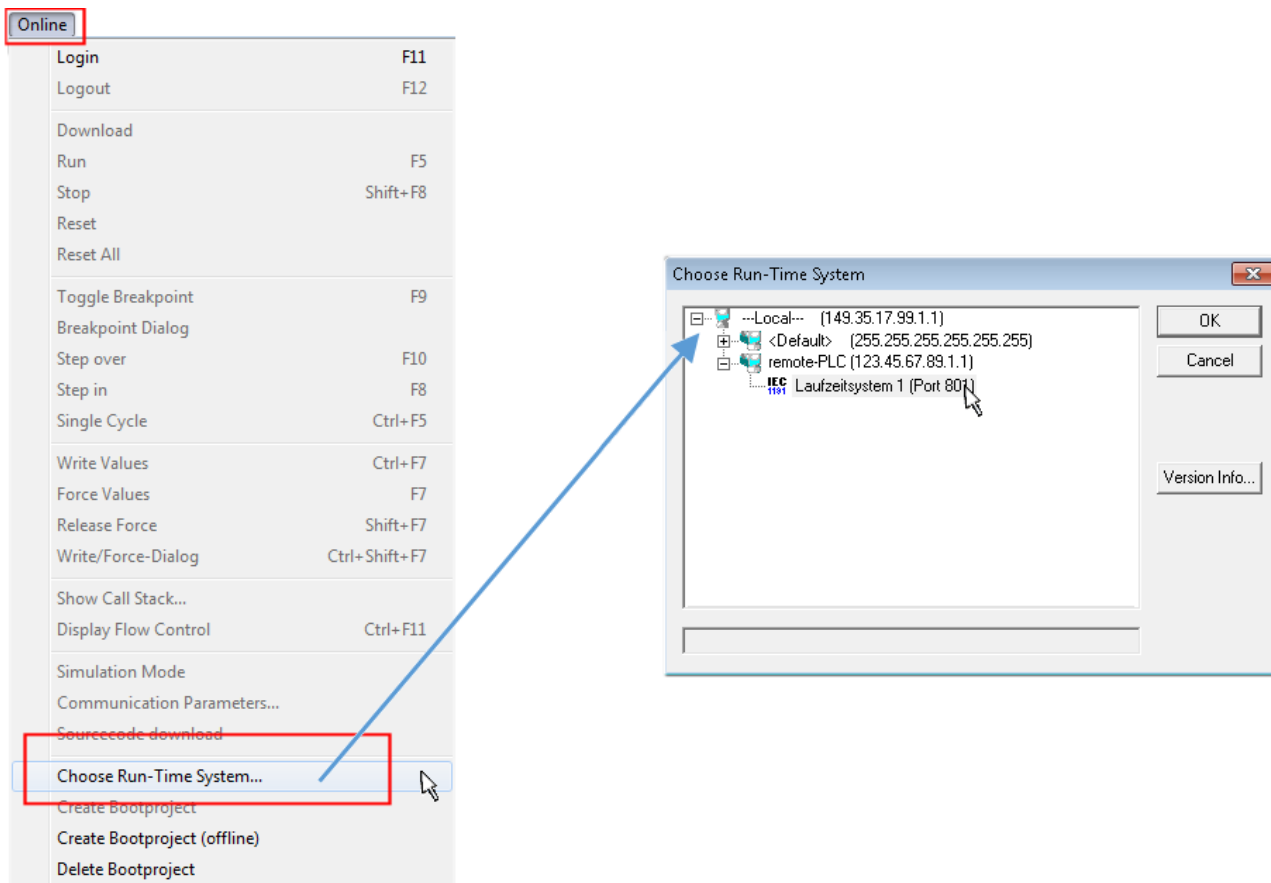



Fig. 61: Choose target system (remote)

In this sample "Runtime system 1 (port 801)" is selected and confirmed. Link the PLC with the real-time

system via menu option "Online" → "Login", the F11 key or by clicking on the symbol . The control program can then be loaded for execution. This results in the message "No program on the controller! Should the new program be loaded?", which should be acknowledged with "Yes". The runtime environment is ready for the program start:

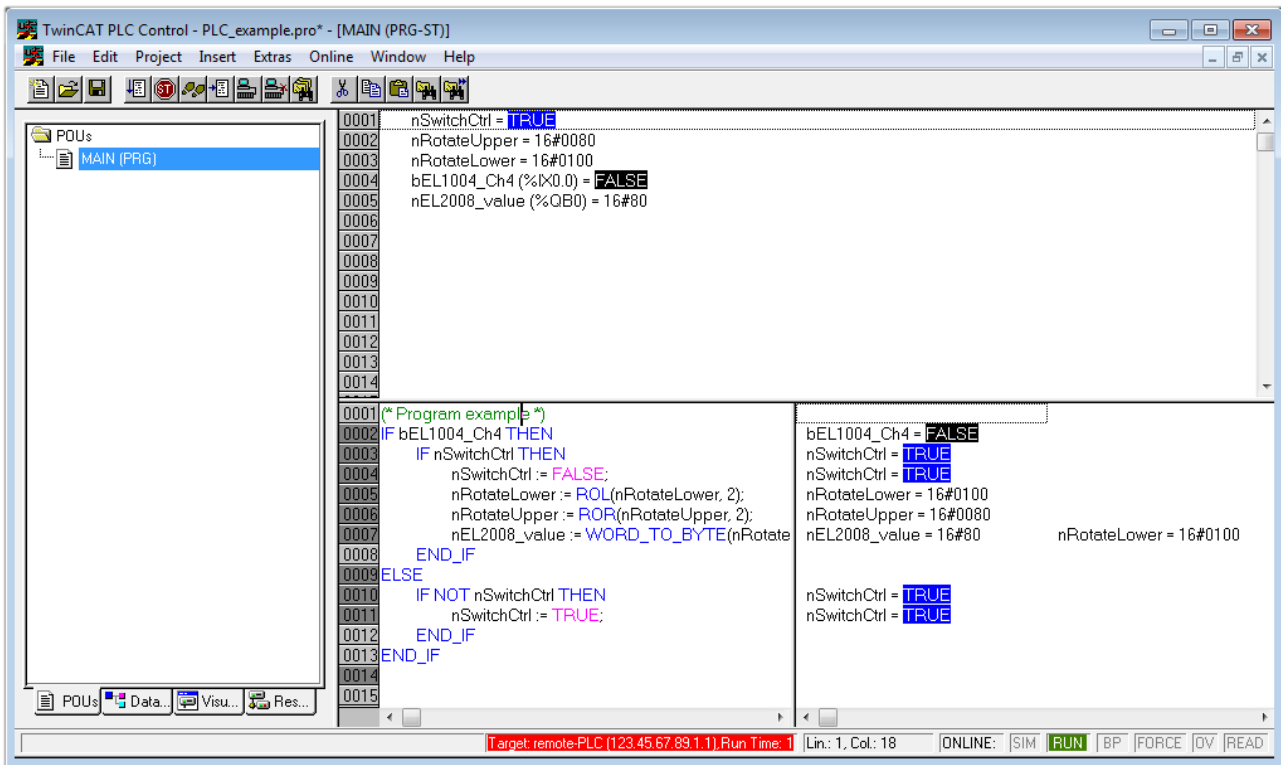

Fig. 62: PLC Control logged in, ready for program startup

The PLC can now be started via "Online" → "Run", F5 key or .

5.1.2 TwinCAT 3

Startup

TwinCAT makes the development environment areas available together with Microsoft Visual Studio: after startup, the project folder explorer appears on the left in the general window area (cf. "TwinCAT System Manager" of TwinCAT 2) for communication with the electromechanical components.

After successful installation of the TwinCAT system on the PC to be used for development, TwinCAT 3 (shell) displays the following user interface after startup:

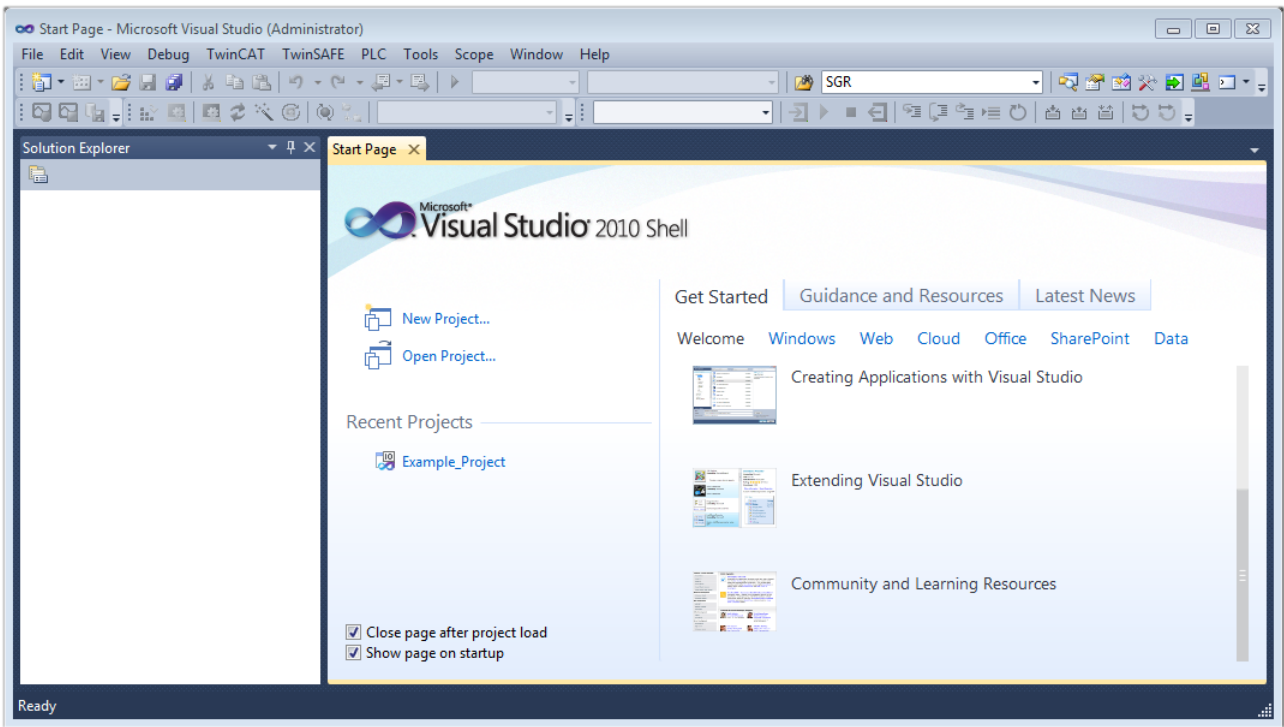



Fig. 63: Initial TwinCAT 3 user interface

First create a new project via  **New TwinCAT Project...** (or under "File"→"New"→"Project..."). In the following dialog make the corresponding entries as required (as shown in the diagram):

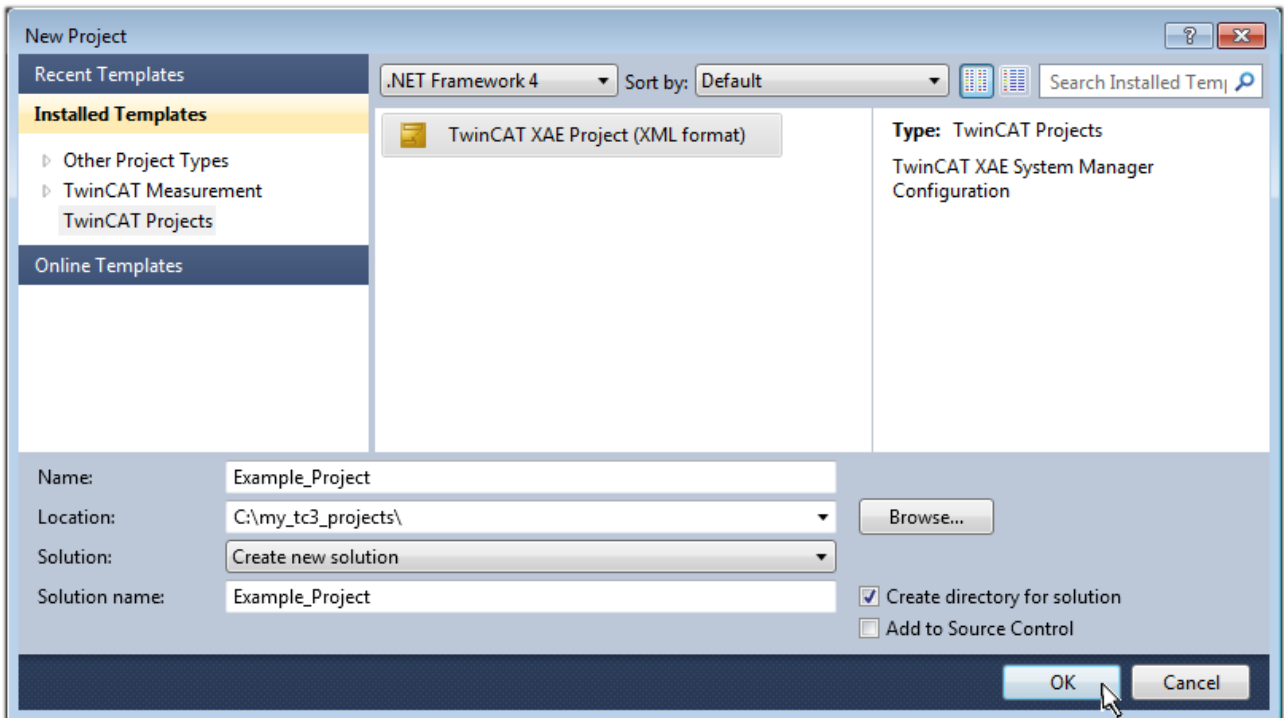

Fig. 64: Create new TwinCAT project

The new project is then available in the project folder explorer:

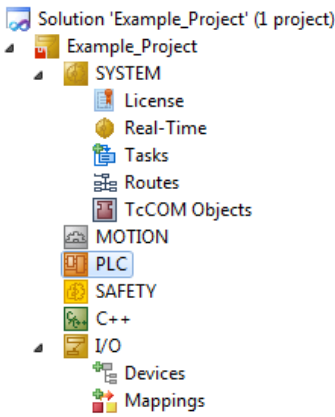
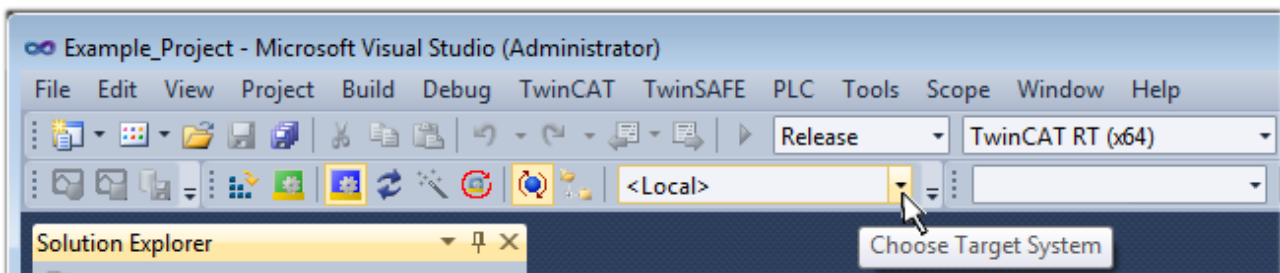

Fig. 65: New TwinCAT3 project in the project folder explorer

Generally, TwinCAT can be used in local or remote mode. Once the TwinCAT system including the user interface (standard) is installed on the respective PLC, TwinCAT can be used in local mode and thereby the next step is "Insert Device [▶ 78]".

If the intention is to address the TwinCAT runtime environment installed on a PLC as development environment remotely from another system, the target system must be made known first. Via the symbol in the menu bar:



expand the pull-down menu:

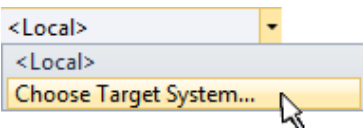

and open the following window:

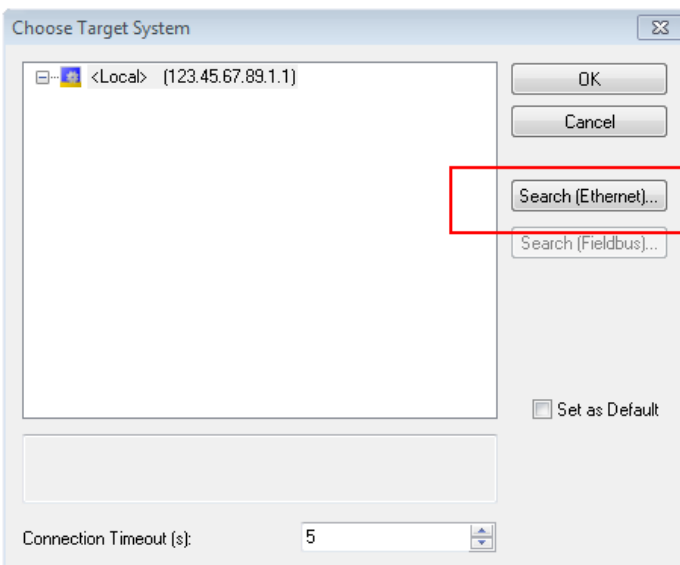

Fig. 66: Selection dialog: Choose the target system

Use "Search (Ethernet)..." to enter the target system. Thus a next dialog opens to either:

- enter the known computer name after "Enter Host Name / IP:" (as shown in red)
- perform a "Broadcast Search" (if the exact computer name is not known)
- enter the known computer IP or AmsNetID.

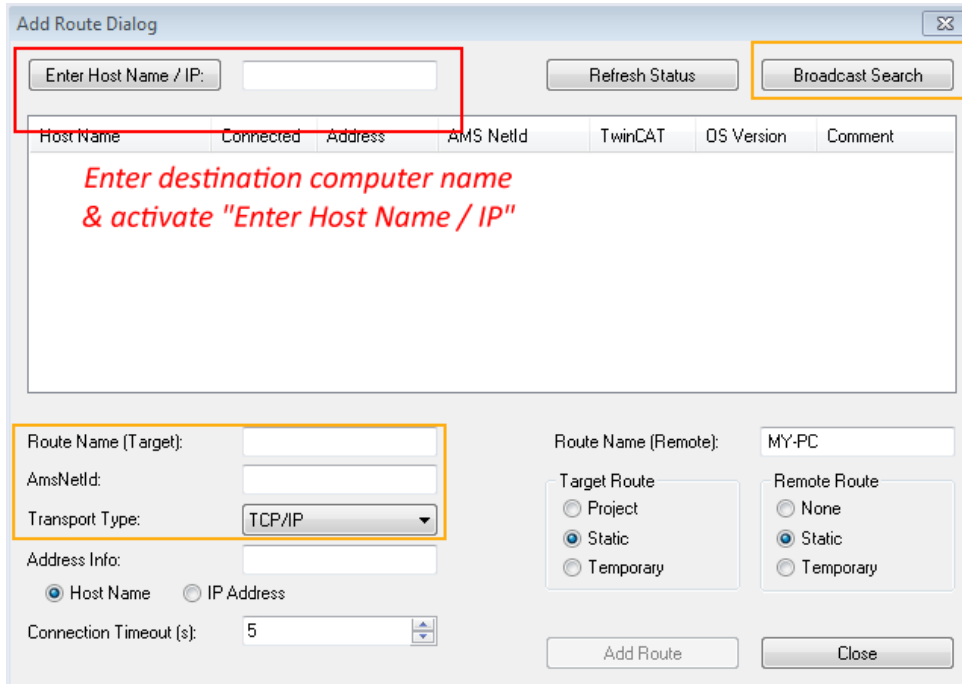
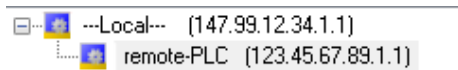

Fig. 67: Specify the PLC for access by the TwinCAT System Manager: selection of the target system

Once the target system has been entered, it is available for selection as follows (a password may have to be entered):



After confirmation with "OK" the target system can be accessed via the Visual Studio shell.

Adding devices

In the project folder explorer of the Visual Studio shell user interface on the left, select "Devices" within

element "I/O", then right-click to open a context menu and select "Scan" or start the action via  in the

menu bar. The TwinCAT System Manager may first have to be set to "Config mode" via  or via the menu "TwinCAT" → "Restart TwinCAT (Config mode)".

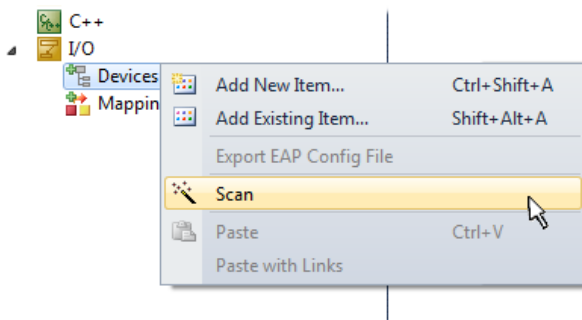

Fig. 68: Select "Scan"

Confirm the warning message, which follows, and select "EtherCAT" in the dialog:

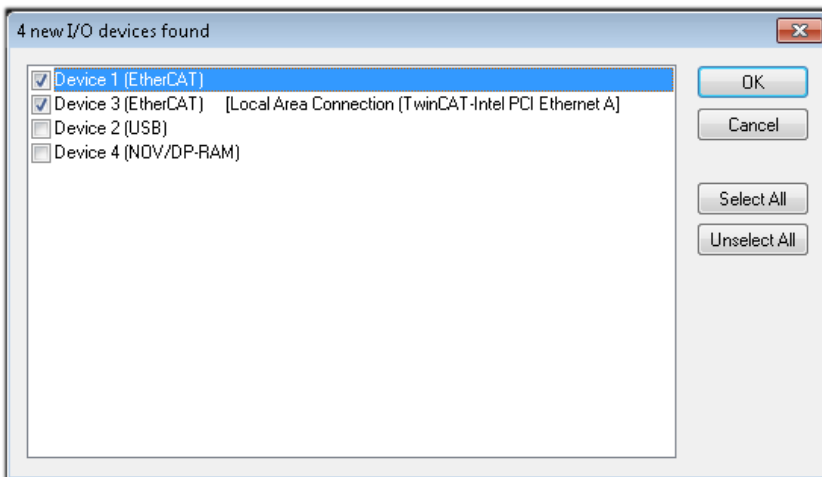

Fig. 69: Automatic detection of I/O devices: selection the devices to be integrated

Confirm the message "Find new boxes", in order to determine the terminals connected to the devices. "Free Run" enables manipulation of input and output values in "Config mode" and should also be acknowledged.

Based on the [sample configuration \[▶ 63\]](#) described at the beginning of this section, the result is as follows:

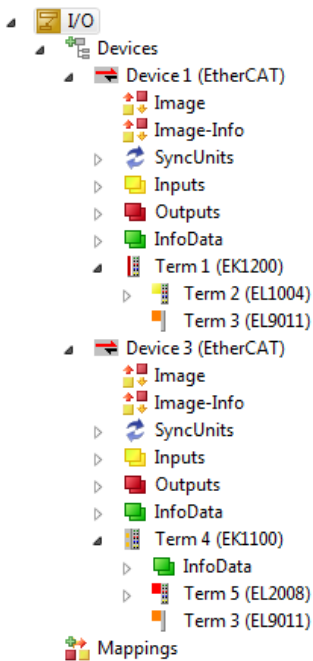

Fig. 70: Mapping of the configuration in VS shell of the TwinCAT3 environment

The whole process consists of two stages, which may be performed separately (first determine the devices, then determine the connected elements such as boxes, terminals, etc.). A scan can also be initiated by selecting "Device ..." from the context menu, which then reads the elements present in the configuration below:

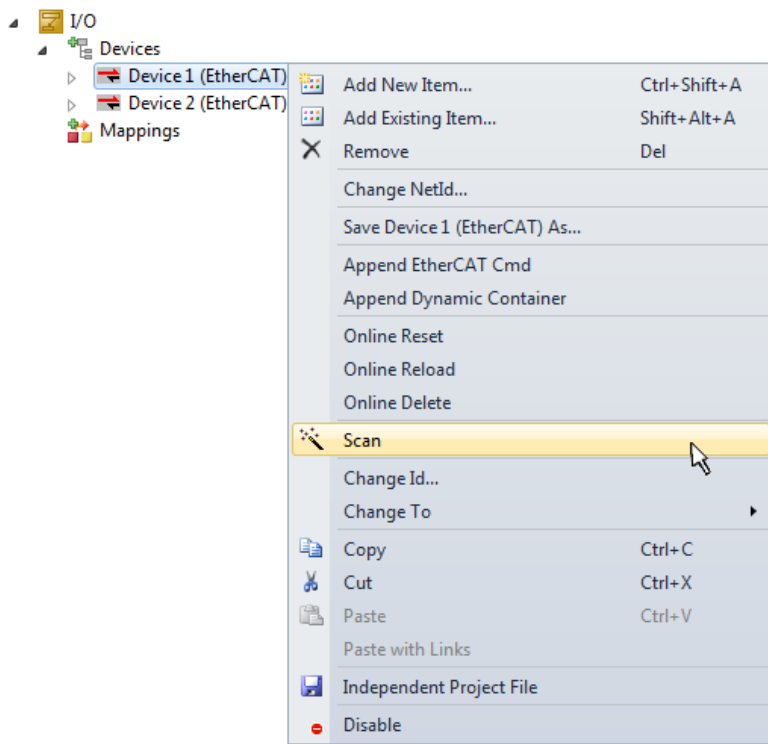

Fig. 71: Reading of individual terminals connected to a device

This functionality is useful if the actual configuration is modified at short notice.

Programming the PLC

TwinCAT PLC Control is the development environment for the creation of the controller in different program environments: TwinCAT PLC Control supports all languages described in IEC 61131-3. There are two text-based languages and three graphical languages.

- **Text-based languages**
 - Instruction List (IL)
 - Structured Text (ST)
- **Graphical languages**
 - Function Block Diagram (FBD)
 - Ladder Diagram (LD)
 - The Continuous Function Chart Editor (CFC)
 - Sequential Function Chart (SFC)

The following section refers to Structured Text (ST).

In order to create a programming environment, a PLC subproject is added to the project sample via the context menu of "PLC" in the project folder explorer by selecting "Add New Item....":

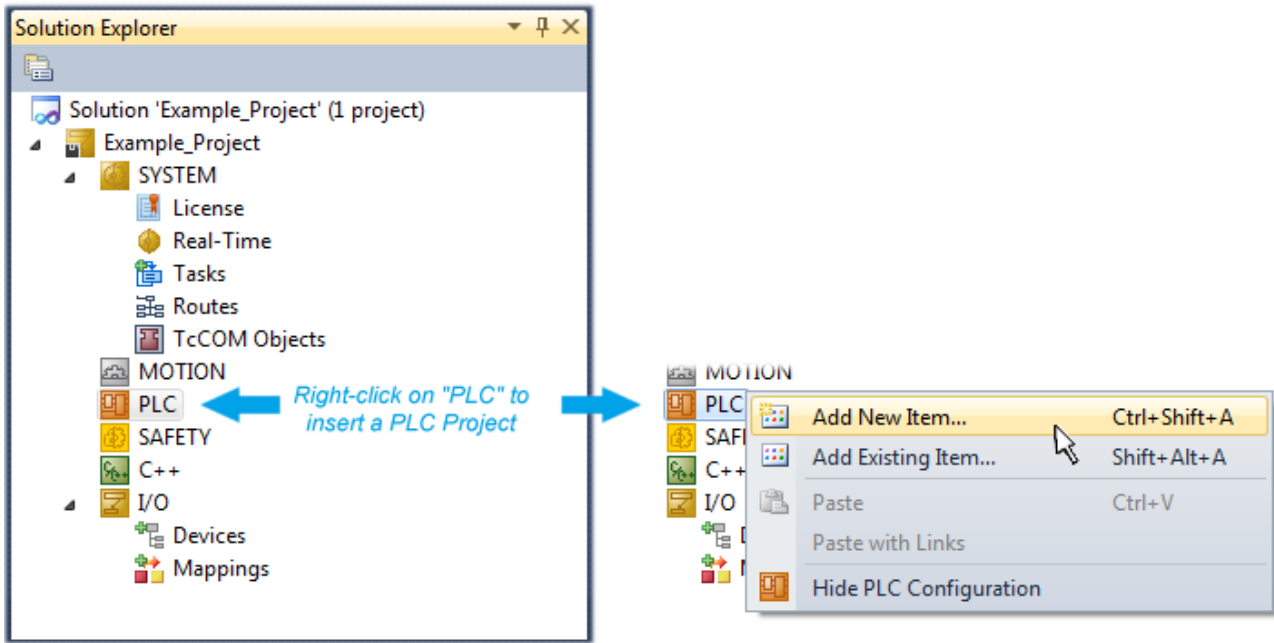

Fig. 72: Adding the programming environment in "PLC"

In the dialog that opens select "Standard PLC project" and enter "PLC_example" as project name, for example, and select a corresponding directory:

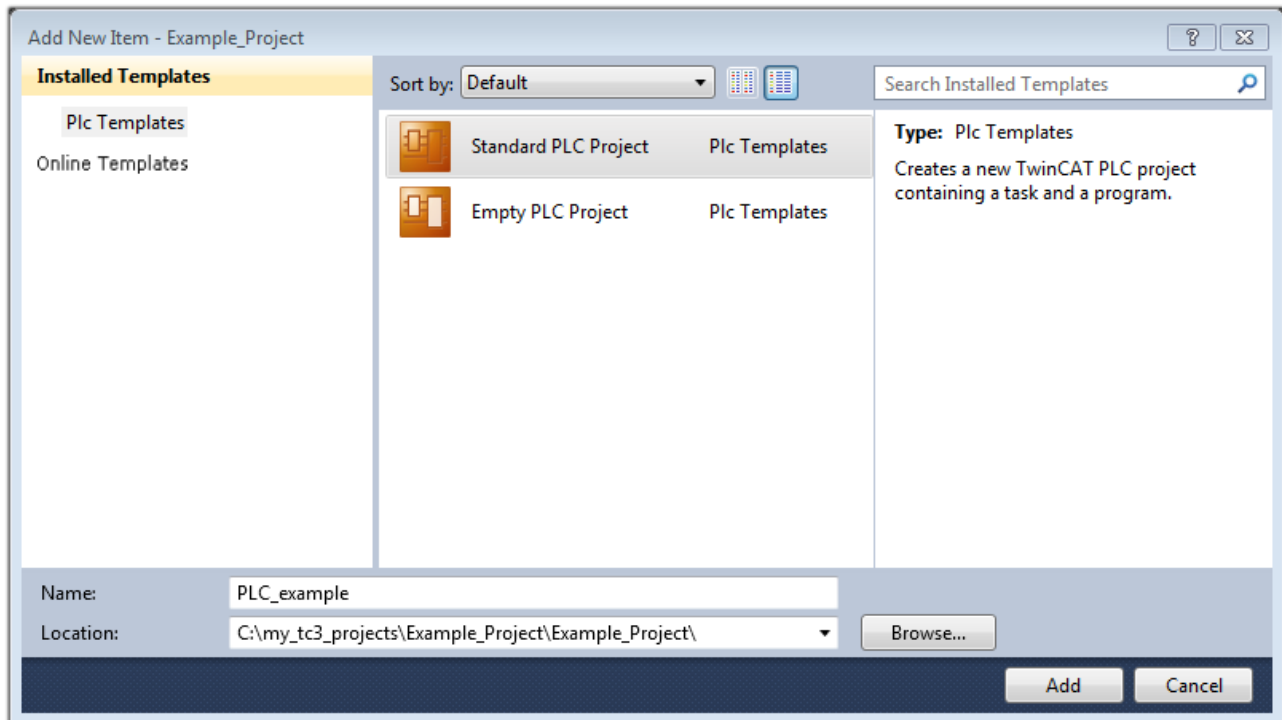

Fig. 73: Specifying the name and directory for the PLC programming environment

The "Main" program, which already exists by selecting "Standard PLC project", can be opened by double-clicking on "PLC_example_project" in "POUs". The following user interface is shown for an initial project:

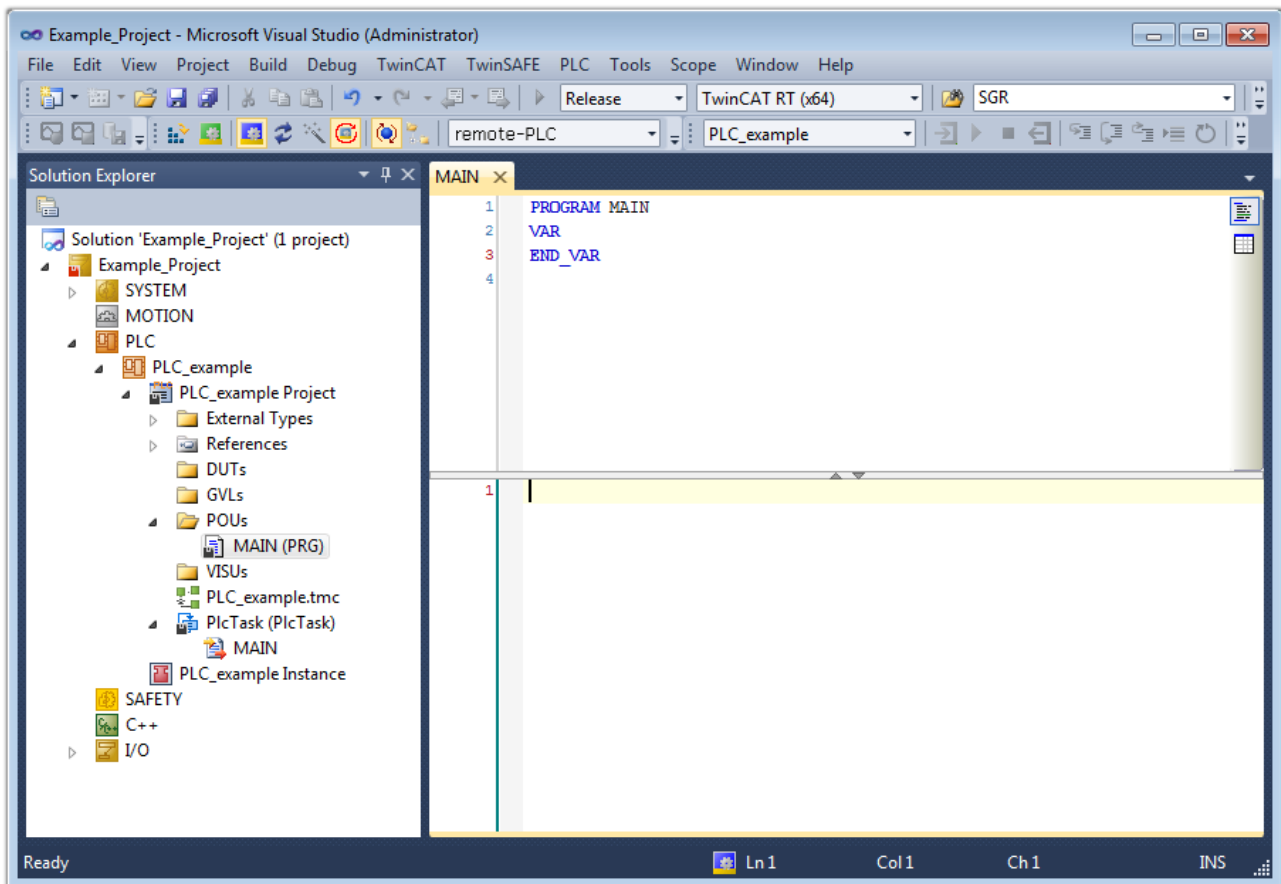

Fig. 74: Initial "Main" program of the standard PLC project

To continue, sample variables and a sample program have now been created:

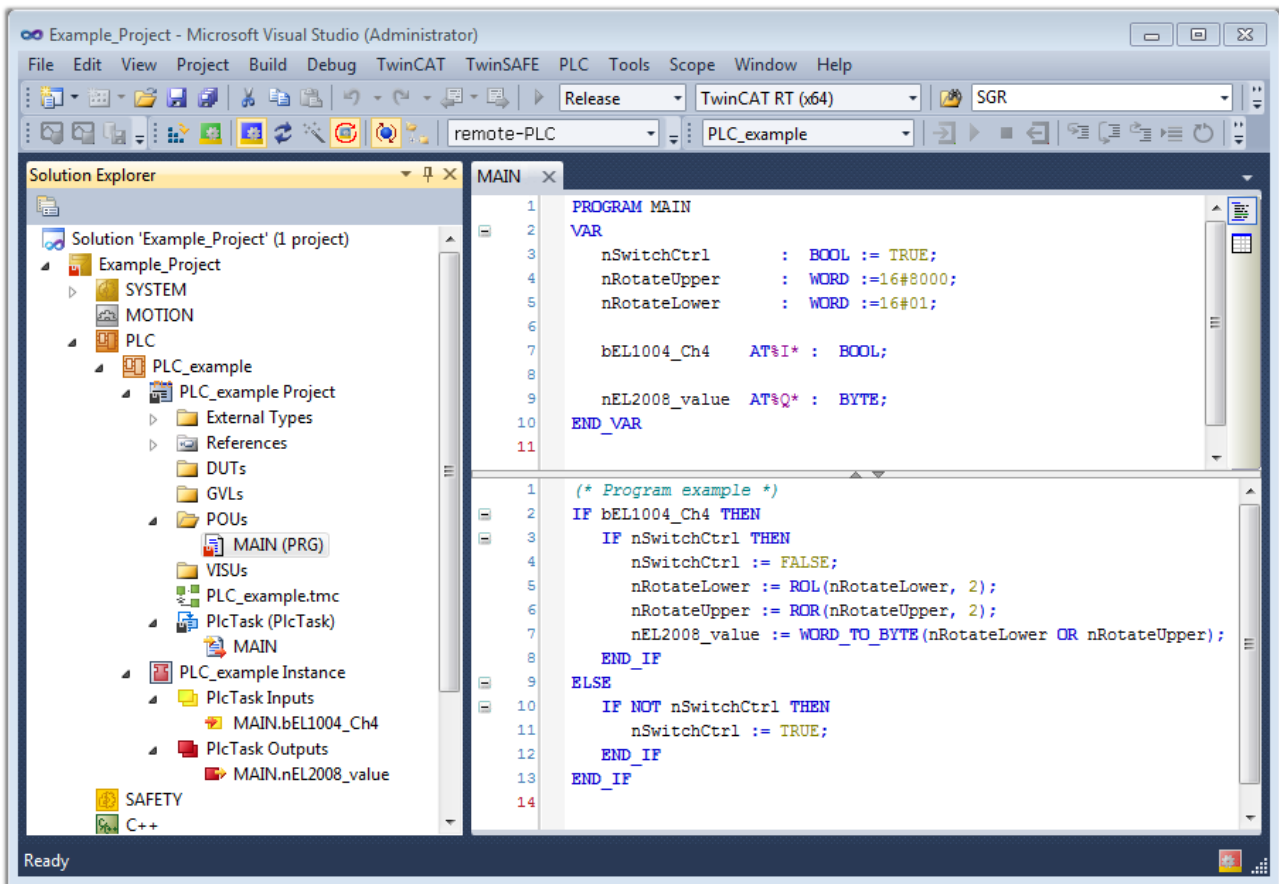

Fig. 75: Sample program with variables after a compile process (without variable integration)

The control program is now created as a project folder, followed by the compile process:

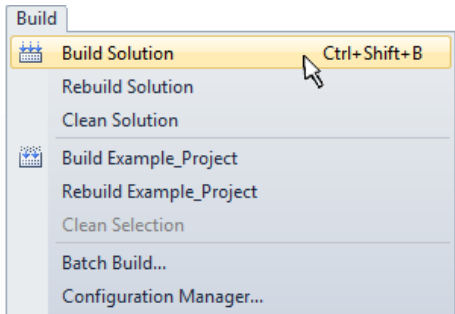
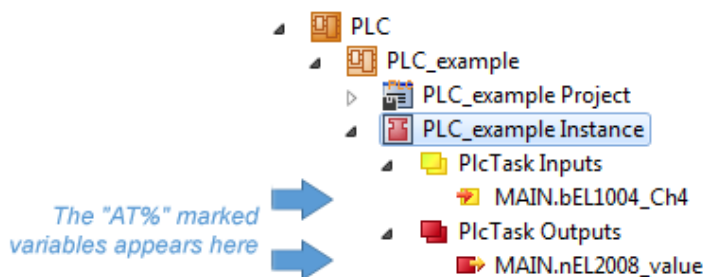

Fig. 76: Start program compilation

The following variables, identified in the ST/ PLC program with "AT%", are then available in under "Assignments" in the project folder explorer:



Assigning variables

Via the menu of an instance - variables in the "PLC" context, use the "Modify Link..." option to open a window for selecting a suitable process object (PDO) for linking:

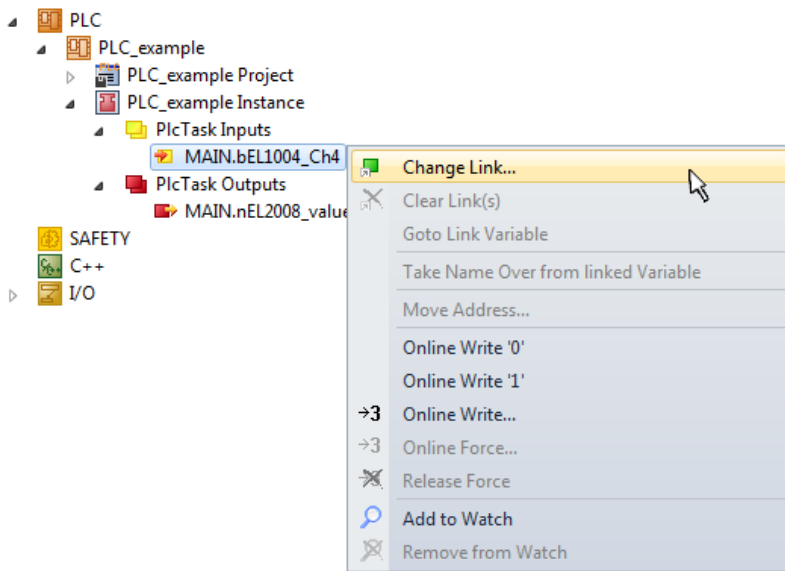

Fig. 77: Creating the links between PLC variables and process objects

In the window that opens, the process object for the variable "bEL1004_Ch4" of type BOOL can be selected from the PLC configuration tree:

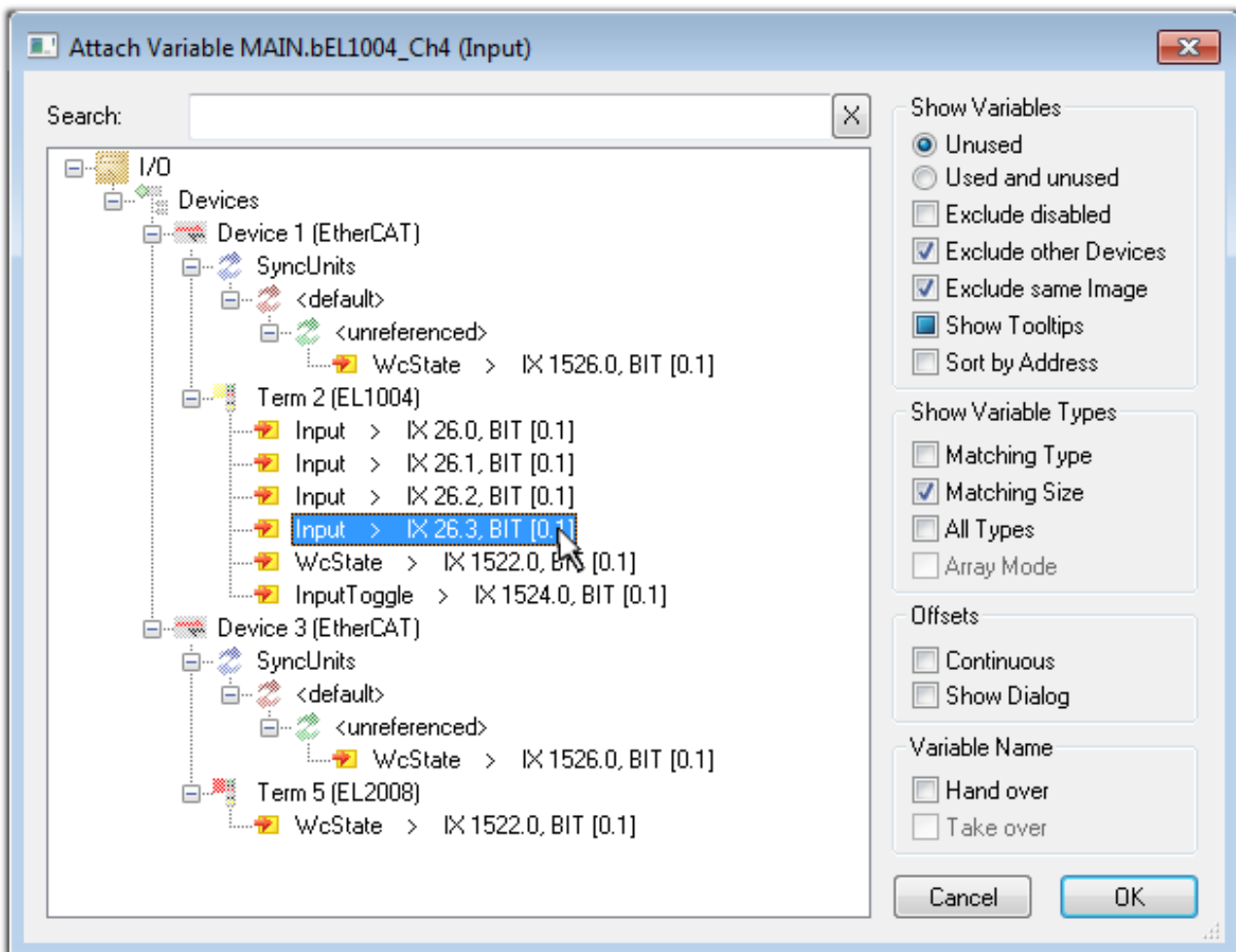

Fig. 78: Selecting PDO of type BOOL

According to the default setting, certain PDO objects are now available for selection. In this sample the input of channel 4 of the EL1004 terminal is selected for linking. In contrast, the checkbox "All types" must be ticked for creating the link for the output variables, in order to allocate a set of eight separate output bits to a byte variable. The following diagram shows the whole process:

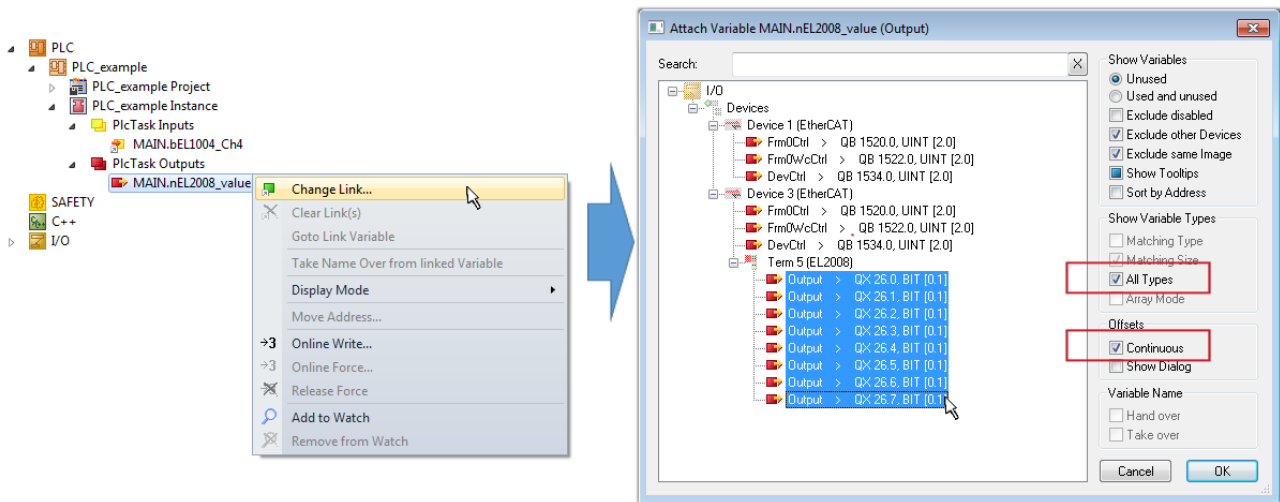



Fig. 79: Selecting several PDOs simultaneously: activate "Continuous" and "All types"

Note that the "Continuous" checkbox was also activated. This is designed to allocate the bits contained in the byte of the variable "nEL2008_value" sequentially to all eight selected output bits of the EL2008 terminal. In this way it is possible to subsequently address all eight outputs of the terminal in the program with a byte corresponding to bit 0 for channel 1 to bit 7 for channel 8 of the PLC. A special symbol () at the yellow or red object of the variable indicates that a link exists. The links can also be checked by selecting a "Goto Link Variable" from the context menu of a variable. The object opposite, in this case the PDO, is automatically selected:

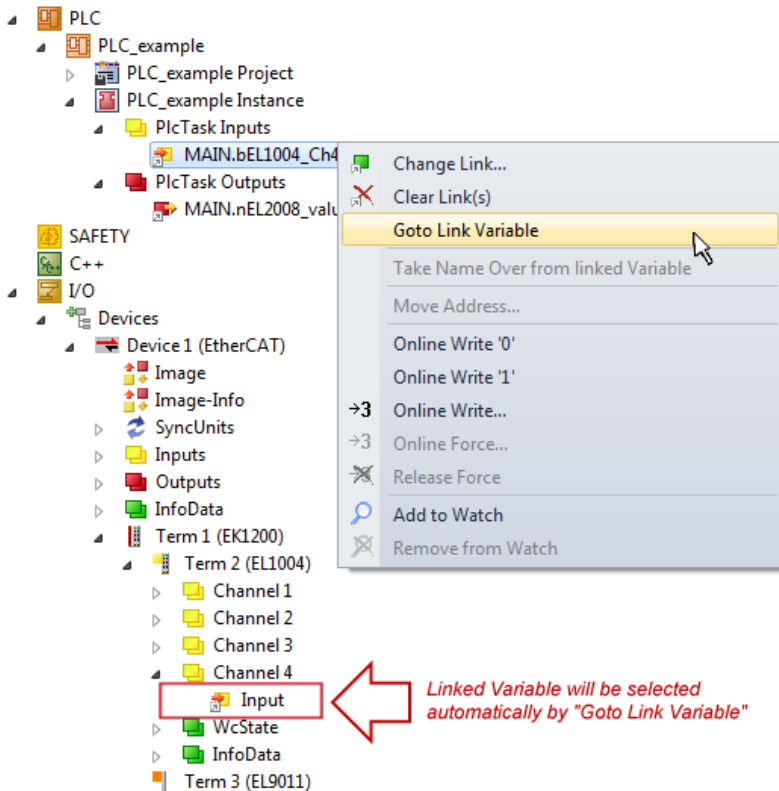

Fig. 80: Application of a "Goto Link" variable, using "MAIN.bEL1004_Ch4" as a sample

The process of creating links can also take place in the opposite direction, i.e. starting with individual PDOs to variable. However, in this example it would then not be possible to select all output bits for the EL2008, since the terminal only makes individual digital outputs available. If a terminal has a byte, word, integer or similar PDO, it is possible to allocate this a set of bit-standardised variables (type "BOOL"). Here, too, a "Goto Link Variable" from the context menu of a PDO can be executed in the other direction, so that the respective PLC instance can then be selected.

Activation of the configuration

The allocation of PDO to PLC variables has now established the connection from the controller to the inputs

and outputs of the terminals. The configuration can now be activated with  or via the menu under "TwinCAT" in order to transfer settings of the development environment to the runtime system. Confirm the messages "Old configurations are overwritten!" and "Restart TwinCAT system in Run mode" with "OK". The corresponding assignments can be seen in the project folder explorer:

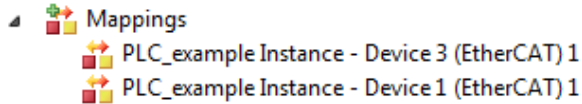

A few seconds later the corresponding status of the Run mode is displayed in the form of a rotating symbol

 at the bottom right of the VS shell development environment. The PLC system can then be started as described below.

Starting the controller

Select the menu option "PLC" → "Login" or click on  to link the PLC with the real-time system and load the control program for execution. This results in the message "No program on the controller! Should the new program be loaded?", which should be acknowledged with "Yes". The runtime environment is ready for

program start by click on symbol , the "F5" key or via "PLC" in the menu selecting "Start". The started programming environment shows the runtime values of individual variables:

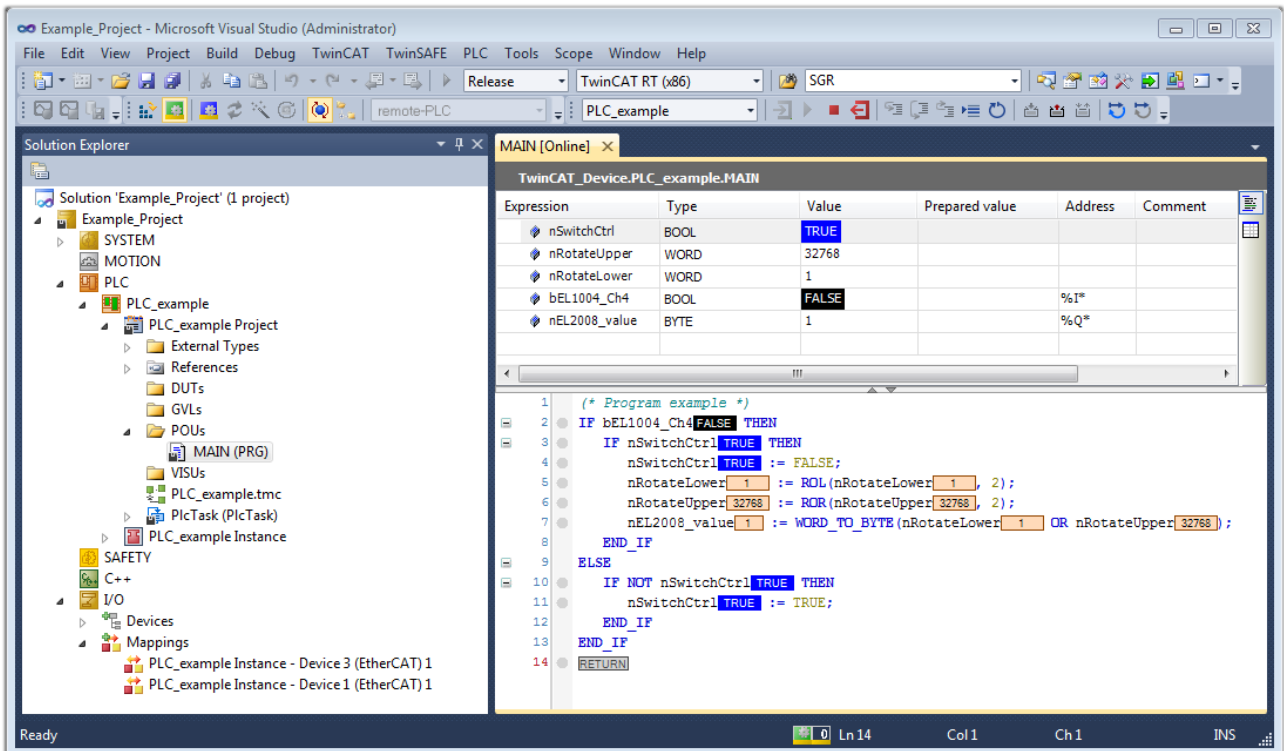

Fig. 81: TwinCAT development environment (VS shell): logged-in, after program startup

The two operator control elements for stopping  and logout  result in the required action (accordingly also for stop "Shift + F5", or both actions can be selected via the PLC menu).

5.2 TwinCAT Development Environment

The Software for automation TwinCAT (The Windows Control and Automation Technology) will be distinguished into:

- TwinCAT 2: System Manager (Configuration) & PLC Control (Programming)
- TwinCAT 3: Enhancement of TwinCAT 2 (Programming and Configuration takes place via a common Development Environment)

Details:

- **TwinCAT 2:**
 - Connects I/O devices to tasks in a variable-oriented manner
 - Connects tasks to tasks in a variable-oriented manner
 - Supports units at the bit level
 - Supports synchronous or asynchronous relationships
 - Exchange of consistent data areas and process images
 - Datalink on NT - Programs by open Microsoft Standards (OLE, OCX, ActiveX, DCOM+, etc.)
 - Integration of IEC 61131-3-Software-SPS, Software- NC and Software-CNC within Windows NT/2000/XP/Vista, Windows 7, NT/XP Embedded, CE
 - Interconnection to all common fieldbusses
 - More...

Additional features:

- **TwinCAT 3 (eXtended Automation):**
 - Visual-Studio®-Integration
 - Choice of the programming language
 - Supports object orientated extension of IEC 61131-3
 - Usage of C/C++ as programming language for real time applications
 - Connection to MATLAB®/Simulink®
 - Open interface for expandability
 - Flexible run-time environment
 - Active support of Multi-Core- und 64-Bit-Operatingsystem
 - Automatic code generation and project creation with the TwinCAT Automation Interface
 - More...

Within the following sections commissioning of the TwinCAT Development Environment on a PC System for the control and also the basically functions of unique control elements will be explained.

Please see further information to TwinCAT 2 and TwinCAT 3 at <http://infosys.beckhoff.com>.

5.2.1 Installation of the TwinCAT real-time driver

In order to assign real-time capability to a standard Ethernet port of an IPC controller, the Beckhoff real-time driver has to be installed on this port under Windows.

This can be done in several ways. One option is described here.

In the System Manager call up the TwinCAT overview of the local network interfaces via Options → Show Real Time Ethernet Compatible Devices.

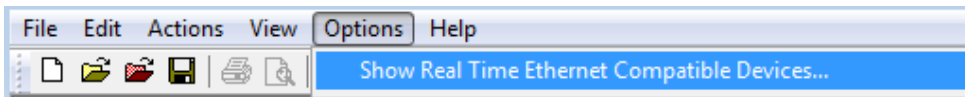

Fig. 82: System Manager "Options" (TwinCAT 2)

This has to be called up by the Menü "TwinCAT" within the TwinCAT 3 environment:

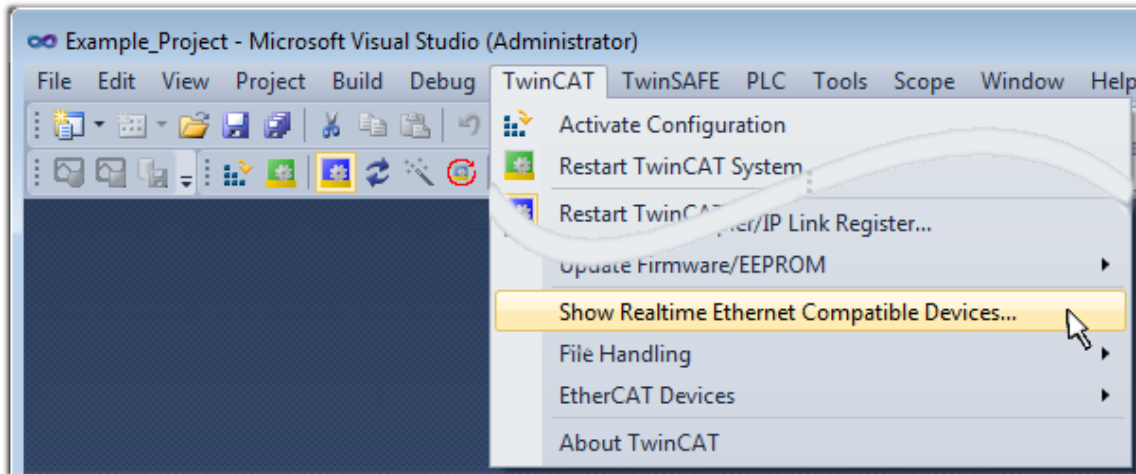

Fig. 83: Call up under VS Shell (TwinCAT 3)

The following dialog appears:

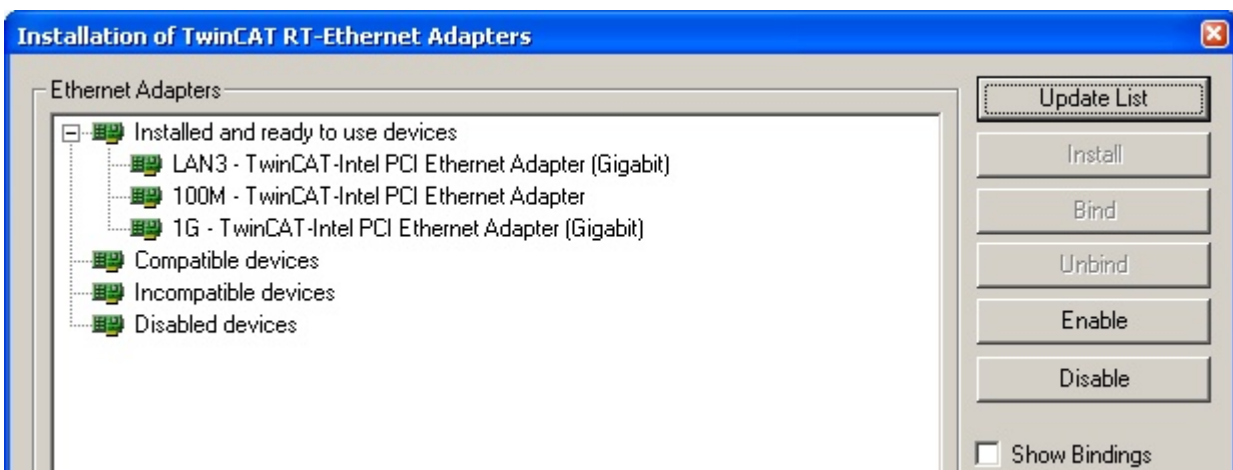

Fig. 84: Overview of network interfaces

Interfaces listed under "Compatible devices" can be assigned a driver via the "Install" button. A driver should only be installed on compatible devices.

A Windows warning regarding the unsigned driver can be ignored.

Alternatively an EtherCAT-device can be inserted first of all as described in chapter [Offline configuration creation, section "Creating the EtherCAT device" \[► 98\]](#) in order to view the compatible ethernet ports via its EtherCAT properties (tab „Adapter“, button „Compatible Devices...“):



Fig. 85: EtherCAT device properties(TwinCAT 2): click on „Compatible Devices...“ of tab “Adapter”

TwinCAT 3: the properties of the EtherCAT device can be opened by double click on “Device .. (EtherCAT)” within the Solution Explorer under “I/O”:



After the installation the driver appears activated in the Windows overview for the network interface (Windows Start → System Properties → Network)

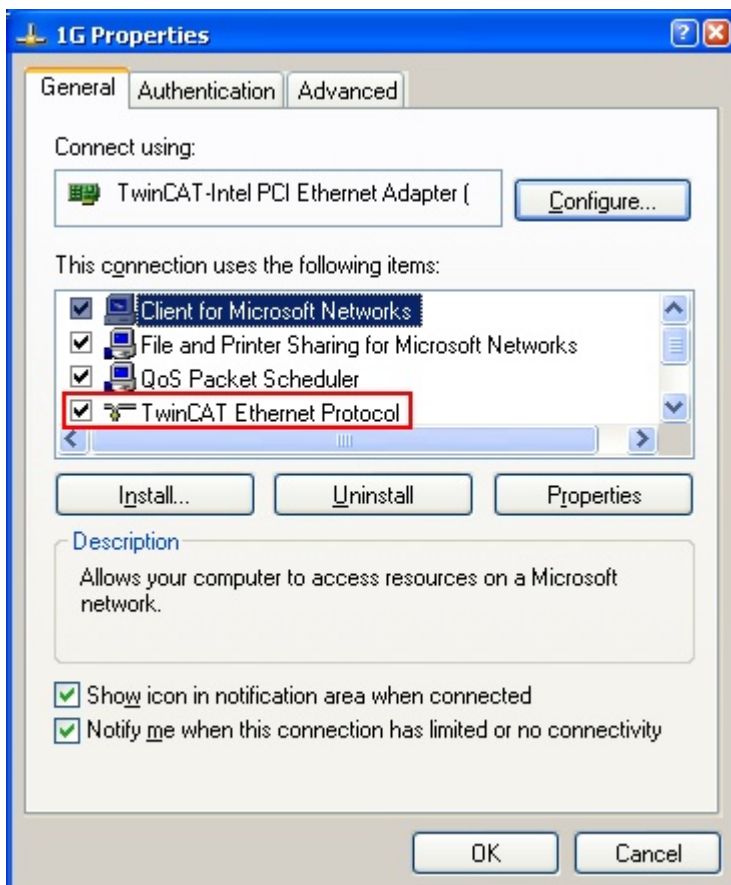

Fig. 86: Windows properties of the network interface

A correct setting of the driver could be:

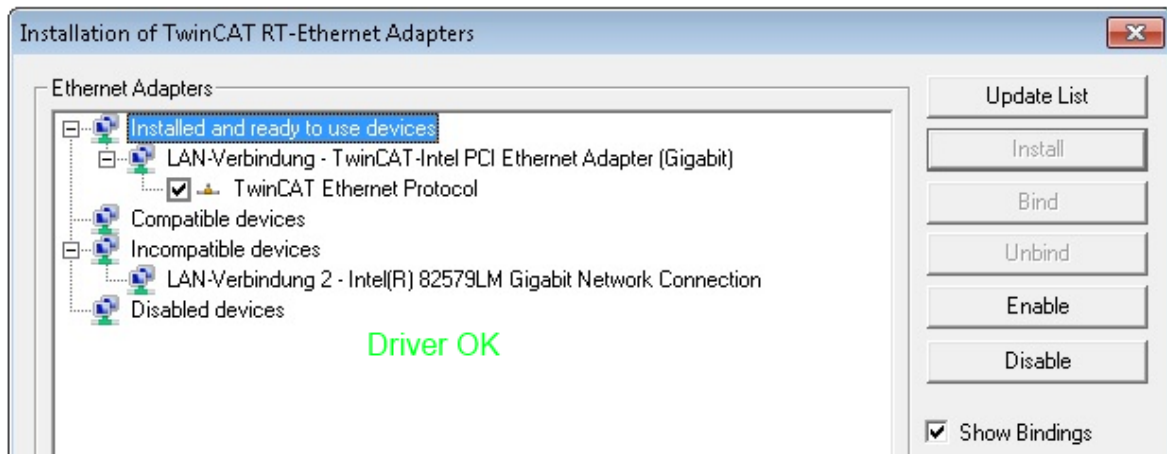

Fig. 87: Exemplary correct driver setting for the Ethernet port

Other possible settings have to be avoided:

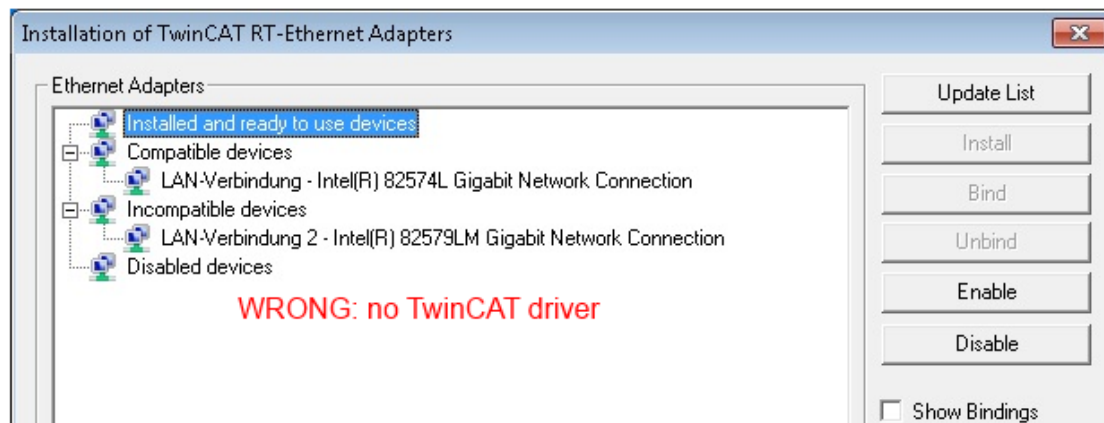
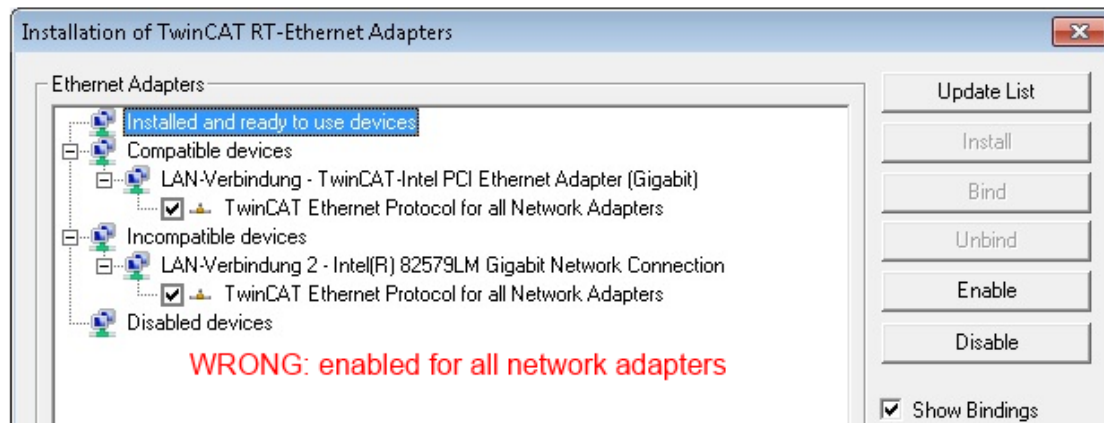
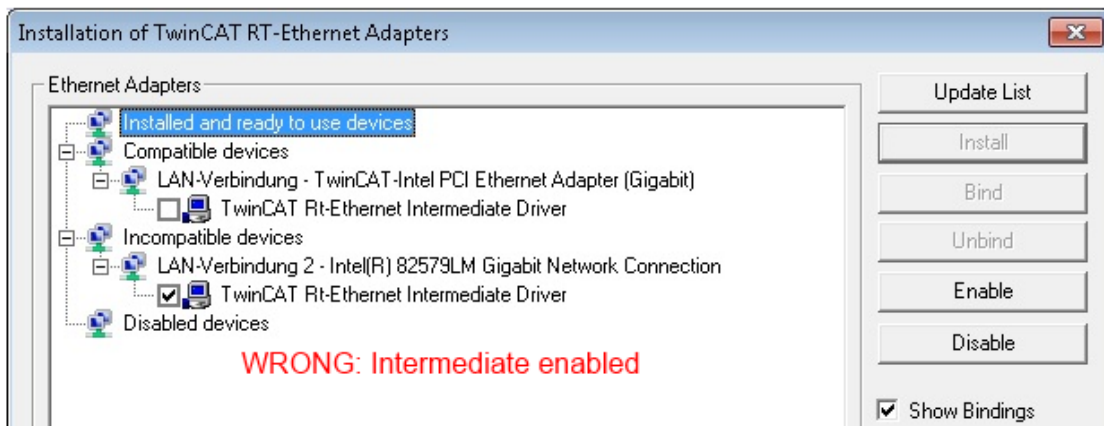
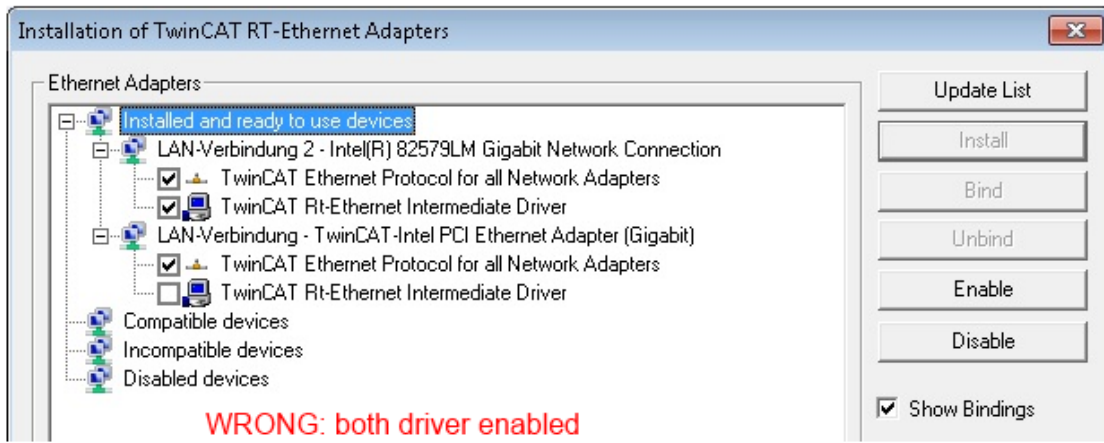

Fig. 88: Incorrect driver settings for the Ethernet port

IP address of the port used

i IP address/DHCP

In most cases an Ethernet port that is configured as an EtherCAT device will not transport general IP packets. For this reason and in cases where an EL6601 or similar devices are used it is useful to specify a fixed IP address for this port via the “Internet Protocol TCP/IP” driver setting and to disable DHCP. In this way the delay associated with the DHCP client for the Ethernet port assigning itself a default IP address in the absence of a DHCP server is avoided. A suitable address space is 192.168.x.x, for example.

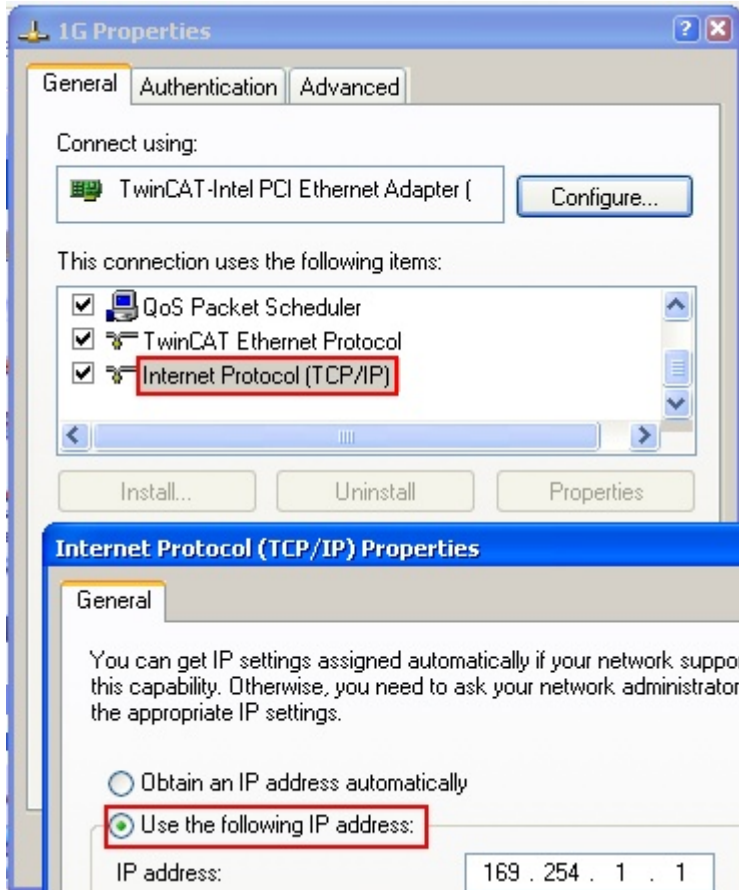

Fig. 89: TCP/IP setting for the Ethernet port

5.2.2 Notes regarding ESI device description

Installation of the latest ESI device description

The TwinCAT EtherCAT master/System Manager needs the device description files for the devices to be used in order to generate the configuration in online or offline mode. The device descriptions are contained in the so-called ESI files (EtherCAT Slave Information) in XML format. These files can be requested from the respective manufacturer and are made available for download. An *.xml file may contain several device descriptions.

The ESI files for Beckhoff EtherCAT devices are available on the [Beckhoff website](#).

The ESI files should be stored in the TwinCAT installation directory.

Default settings:

- **TwinCAT 2:** C:\TwinCAT\IO\EtherCAT
- **TwinCAT 3:** C:\TwinCAT\3.1\Config\Io\EtherCAT

The files are read (once) when a new System Manager window is opened, if they have changed since the last time the System Manager window was opened.

A TwinCAT installation includes the set of Beckhoff ESI files that was current at the time when the TwinCAT build was created.

For TwinCAT 2.11/TwinCAT 3 and higher, the ESI directory can be updated from the System Manager, if the programming PC is connected to the Internet; by

- **TwinCAT 2:** Option → “Update EtherCAT Device Descriptions”
- **TwinCAT 3:** TwinCAT → EtherCAT Devices → “Update Device Descriptions (via ETG Website)...”

The [TwinCAT ESI Updater \[► 97\]](#) is available for this purpose.



ESI

The *.xml files are associated with *.xsd files, which describe the structure of the ESI XML files. To update the ESI device descriptions, both file types should therefore be updated.

Device differentiation

EtherCAT devices/slaves are distinguished by four properties, which determine the full device identifier. For example, the device identifier EL2521-0025-1018 consists of:

- family key “EL”
- name “2521”
- type “0025”
- and revision “1018”

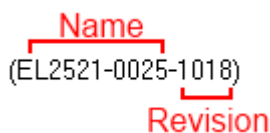

Fig. 90: Identifier structure

The order identifier consisting of name + type (here: EL2521-0010) describes the device function. The revision indicates the technical progress and is managed by Beckhoff. In principle, a device with a higher revision can replace a device with a lower revision, unless specified otherwise, e.g. in the documentation. Each revision has its own ESI description. See [further notes \[► 11\]](#).

Online description

If the EtherCAT configuration is created online through scanning of real devices (see section Online setup) and no ESI descriptions are available for a slave (specified by name and revision) that was found, the System Manager asks whether the description stored in the device should be used. In any case, the System Manager needs this information for setting up the cyclic and acyclic communication with the slave correctly.

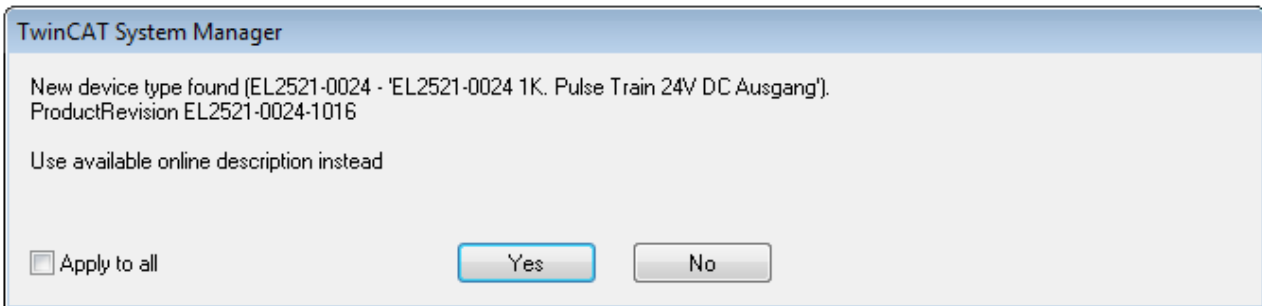

Fig. 91: *OnlineDescription information window (TwinCAT 2)*

In TwinCAT 3 a similar window appears, which also offers the Web update:

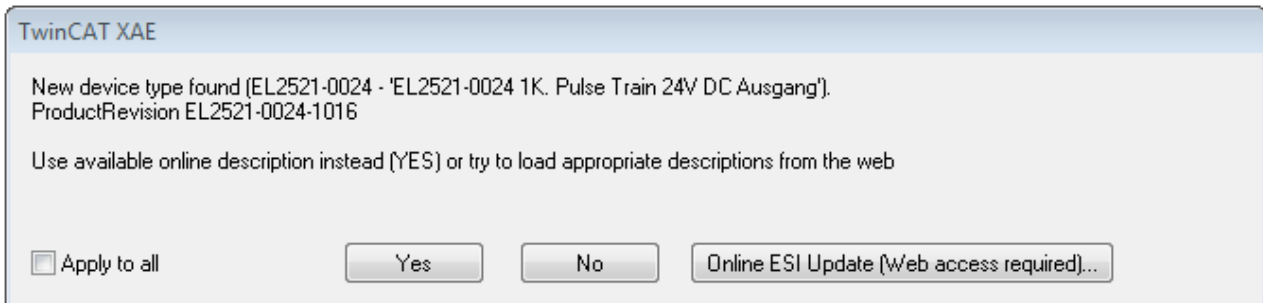

Fig. 92: *Information window OnlineDescription (TwinCAT 3)*

If possible, the Yes is to be rejected and the required ESI is to be requested from the device manufacturer. After installation of the XML/XSD file the configuration process should be repeated.

NOTE

Changing the 'usual' configuration through a scan

- ✓ If a scan discovers a device that is not yet known to TwinCAT, distinction has to be made between two cases. Taking the example here of the EL2521-0000 in the revision 1019
 - a) no ESI is present for the EL2521-0000 device at all, either for the revision 1019 or for an older revision. The ESI must then be requested from the manufacturer (in this case Beckhoff).
 - b) an ESI is present for the EL2521-0000 device, but only in an older revision, e.g. 1018 or 1017. In this case an in-house check should first be performed to determine whether the spare parts stock allows the integration of the increased revision into the configuration at all. A new/higher revision usually also brings along new features. If these are not to be used, work can continue without reservations with the previous revision 1018 in the configuration. This is also stated by the Beckhoff compatibility rule.

Refer in particular to the chapter '[General notes on the use of Beckhoff EtherCAT IO components](#)' and for manual configuration to the chapter '[Offline configuration creation](#)' [[▶ 98](#)].

If the OnlineDescription is used regardless, the System Manager reads a copy of the device description from the EEPROM in the EtherCAT slave. In complex slaves the size of the EEPROM may not be sufficient for the complete ESI, in which case the ESI would be *incomplete* in the configurator. Therefore it's recommended using an offline ESI file with priority in such a case.

The System Manager creates for online recorded device descriptions a new file "OnlineDescription0000...xml" in its ESI directory, which contains all ESI descriptions that were read online.

OnlineDescriptionCache00000002.xml

Fig. 93: File OnlineDescription.xml created by the System Manager

If a slave desired to be added manually to the configuration at a later stage, online created slaves are indicated by a prepended symbol ">" in the selection list (see Figure "Indication of an online recorded ESI of EL2521 as an example").

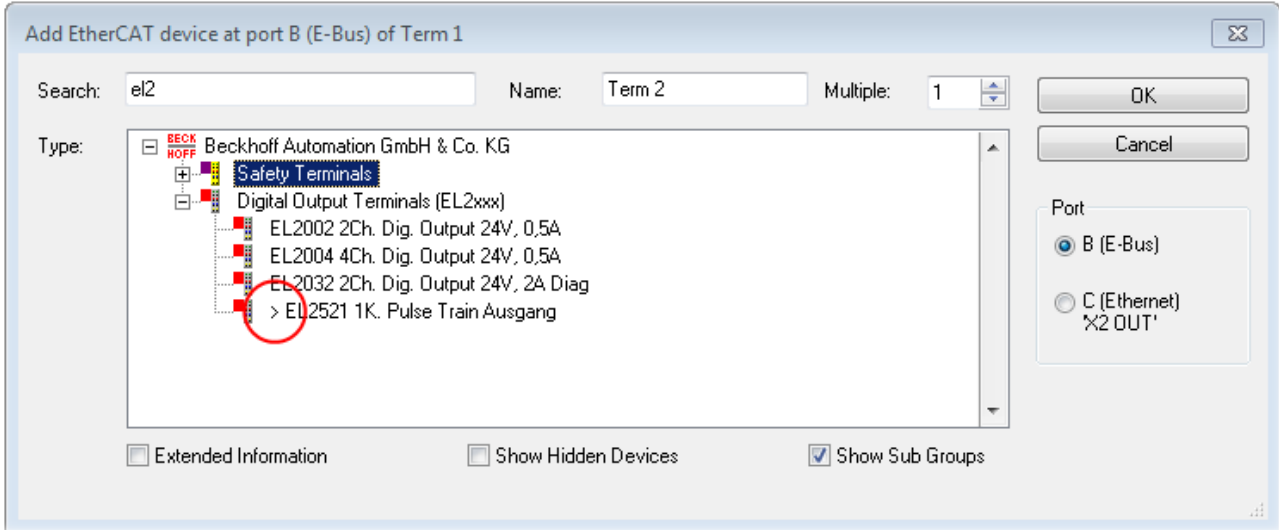

Fig. 94: Indication of an online recorded ESI of EL2521 as an example

If such ESI files are used and the manufacturer's files become available later, the file OnlineDescription.xml should be deleted as follows:

- close all System Manager windows
- restart TwinCAT in Config mode
- delete "OnlineDescription0000...xml"
- restart TwinCAT System Manager

This file should not be visible after this procedure, if necessary press <F5> to update

i OnlineDescription for TwinCAT 3.x

In addition to the file described above "OnlineDescription0000...xml", a so called EtherCAT cache with new discovered devices is created by TwinCAT 3.x, e.g. under Windows 7:

C:\User\[USERNAME]\AppData\Roaming\Beckhoff\TwinCAT3\Components\Base\EtherCATCache.xml

(Please note the language settings of the OS!)

You have to delete this file, too.

Faulty ESI file

If an ESI file is faulty and the System Manager is unable to read it, the System Manager brings up an information window.

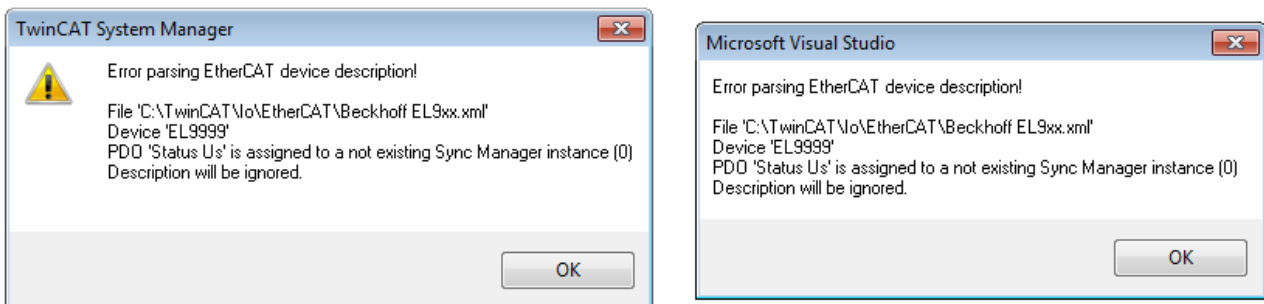

Fig. 95: Information window for faulty ESI file (left: TwinCAT 2; right: TwinCAT 3)

Reasons may include:

- Structure of the *.xml does not correspond to the associated *.xsd file → check your schematics
- Contents cannot be translated into a device description → contact the file manufacturer

5.2.3 TwinCAT ESI Updater

For TwinCAT 2.11 and higher, the System Manager can search for current Beckhoff ESI files automatically, if an online connection is available:

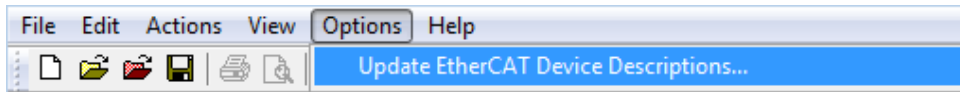

Fig. 96: Using the ESI Updater (>= TwinCAT 2.11)

The call up takes place under:
 “Options” → “Update EtherCAT Device Descriptions”

Selection under TwinCAT 3:

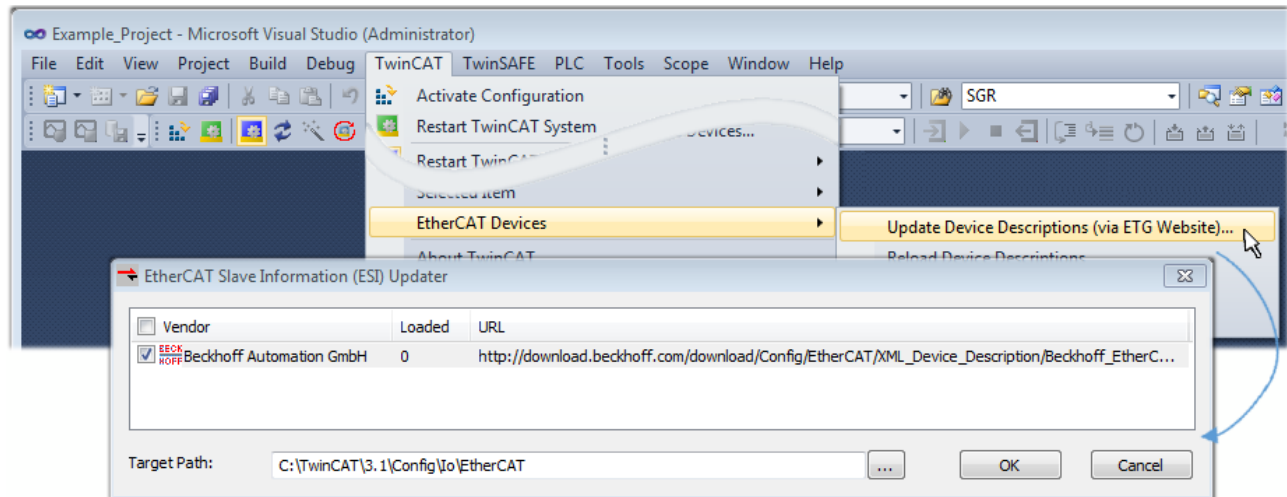

Fig. 97: Using the ESI Updater (TwinCAT 3)

The ESI Updater (TwinCAT 3) is a convenient option for automatic downloading of ESI data provided by EtherCAT manufacturers via the Internet into the TwinCAT directory (ESI = EtherCAT slave information). TwinCAT accesses the central ESI ULR directory list stored at ETG; the entries can then be viewed in the Updater dialog, although they cannot be changed there.

The call up takes place under:
 “TwinCAT” → „EtherCAT Devices“ → “Update Device Description (via ETG Website)...”.

5.2.4 Distinction between Online and Offline

The distinction between online and offline refers to the presence of the actual I/O environment (drives, terminals, EJ-modules). If the configuration is to be prepared in advance of the system configuration as a programming system, e.g. on a laptop, this is only possible in “Offline configuration” mode. In this case all components have to be entered manually in the configuration, e.g. based on the electrical design.

If the designed control system is already connected to the EtherCAT system and all components are energised and the infrastructure is ready for operation, the TwinCAT configuration can simply be generated through “scanning” from the runtime system. This is referred to as online configuration.

In any case, during each startup the EtherCAT master checks whether the slaves it finds match the configuration. This test can be parameterised in the extended slave settings. Refer to note “Installation of the latest ESI-XML device description” [▶ 93].

For preparation of a configuration:

- the real EtherCAT hardware (devices, couplers, drives) must be present and installed
- the devices/modules must be connected via EtherCAT cables or in the terminal/ module strand in the same way as they are intended to be used later

- the devices/modules be connected to the power supply and ready for communication
- TwinCAT must be in CONFIG mode on the target system.

The online scan process consists of:

- detecting the EtherCAT device [▶ 103] (Ethernet port at the IPC)
- detecting the connected EtherCAT devices [▶ 104]. This step can be carried out independent of the preceding step
- troubleshooting [▶ 107]

The scan with existing configuration [▶ 108] can also be carried out for comparison.

5.2.5 OFFLINE configuration creation

Creating the EtherCAT device

Create an EtherCAT device in an empty System Manager window.

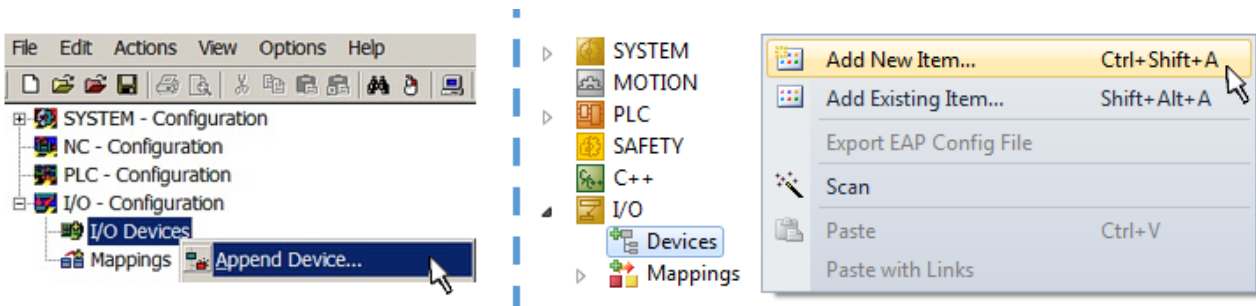

Fig. 98: Append EtherCAT device (left: TwinCAT 2; right: TwinCAT 3)

Select type 'EtherCAT' for an EtherCAT I/O application with EtherCAT slaves. For the present publisher/ subscriber service in combination with an EL6601/EL6614 terminal select "EtherCAT Automation Protocol via EL6601".

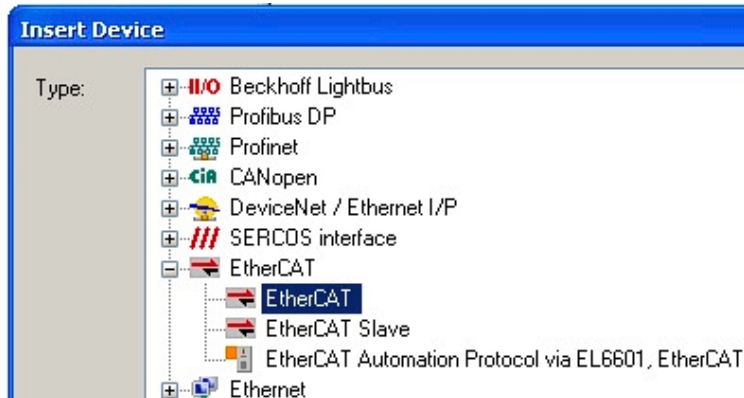

Fig. 99: Selecting the EtherCAT connection (TwinCAT 2.11, TwinCAT 3)

Then assign a real Ethernet port to this virtual device in the runtime system.

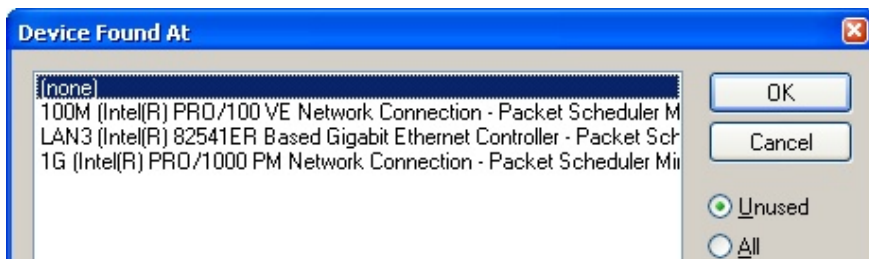

Fig. 100: Selecting the Ethernet port

This query may appear automatically when the EtherCAT device is created, or the assignment can be set/modified later in the properties dialog; see Fig. “EtherCAT device properties (TwinCAT 2)”.

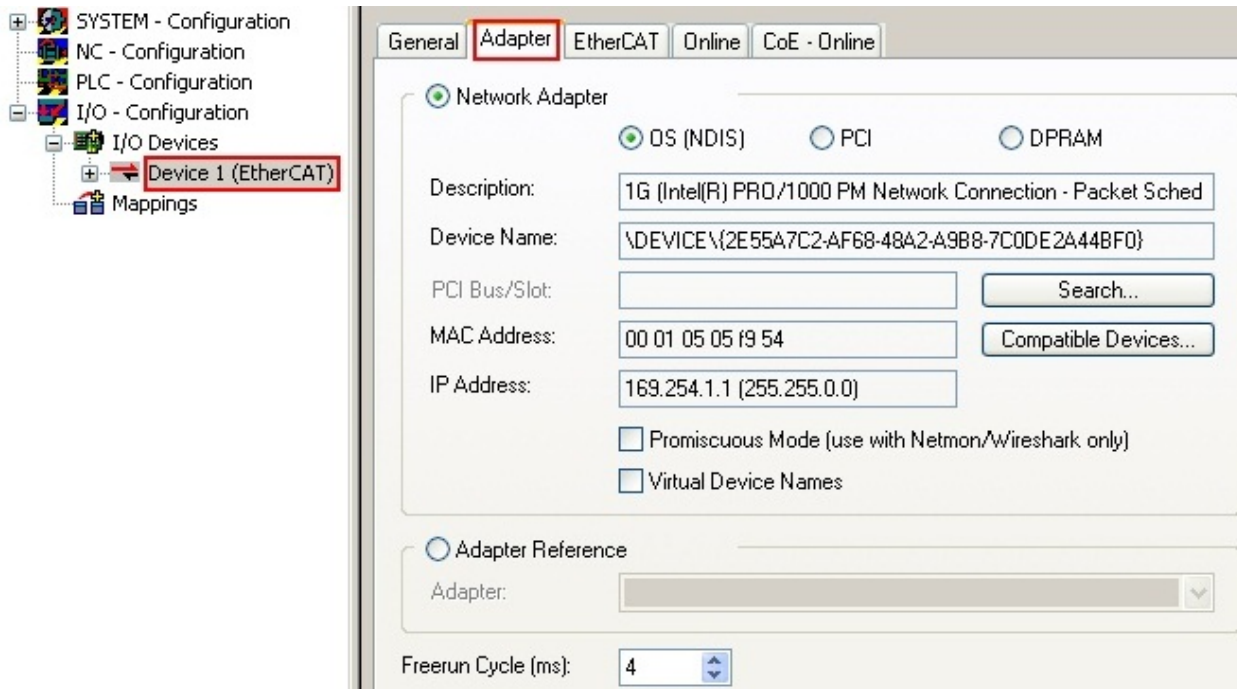
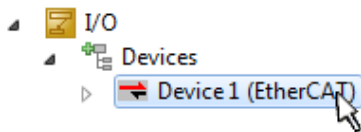

Fig. 101: EtherCAT device properties (TwinCAT 2)

TwinCAT 3: the properties of the EtherCAT device can be opened by double click on “Device .. (EtherCAT)” within the Solution Explorer under “I/O”:



i **Selecting the Ethernet port**

Ethernet ports can only be selected for EtherCAT devices for which the TwinCAT real-time driver is installed. This has to be done separately for each port. Please refer to the respective [installation page \[▶ 87\]](#).

Defining EtherCAT slaves

Further devices can be appended by right-clicking on a device in the configuration tree.

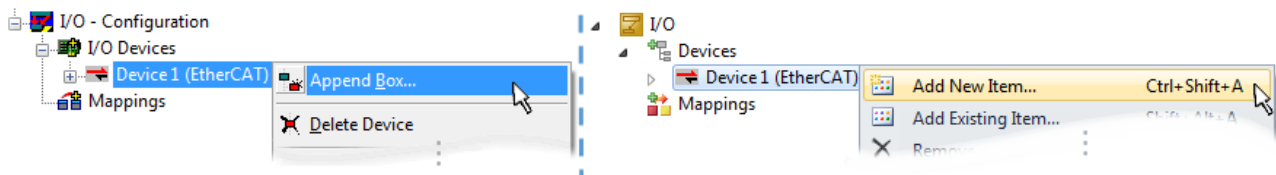

Fig. 102: Appending EtherCAT devices (left: TwinCAT 2; right: TwinCAT 3)

The dialog for selecting a new device opens. Only devices for which ESI files are available are displayed.

Only devices are offered for selection that can be appended to the previously selected device. Therefore the physical layer available for this port is also displayed (Fig. “Selection dialog for new EtherCAT device”, A). In the case of cable-based Fast-Ethernet physical layer with PHY transfer, then also only cable-based devices are available, as shown in Fig. “Selection dialog for new EtherCAT device”. If the preceding device has several free ports (e.g. EK1122 or EK1100), the required port can be selected on the right-hand side (A).

Overview of physical layer

- “Ethernet”: cable-based 100BASE-TX: EK couplers, EP boxes, devices with RJ45/M8/M12 connector

- “E-Bus”: LVDS “terminal bus”, “EJ-module”: EL/ES terminals, various modular modules

The search field facilitates finding specific devices (since TwinCAT 2.11 or TwinCAT 3).

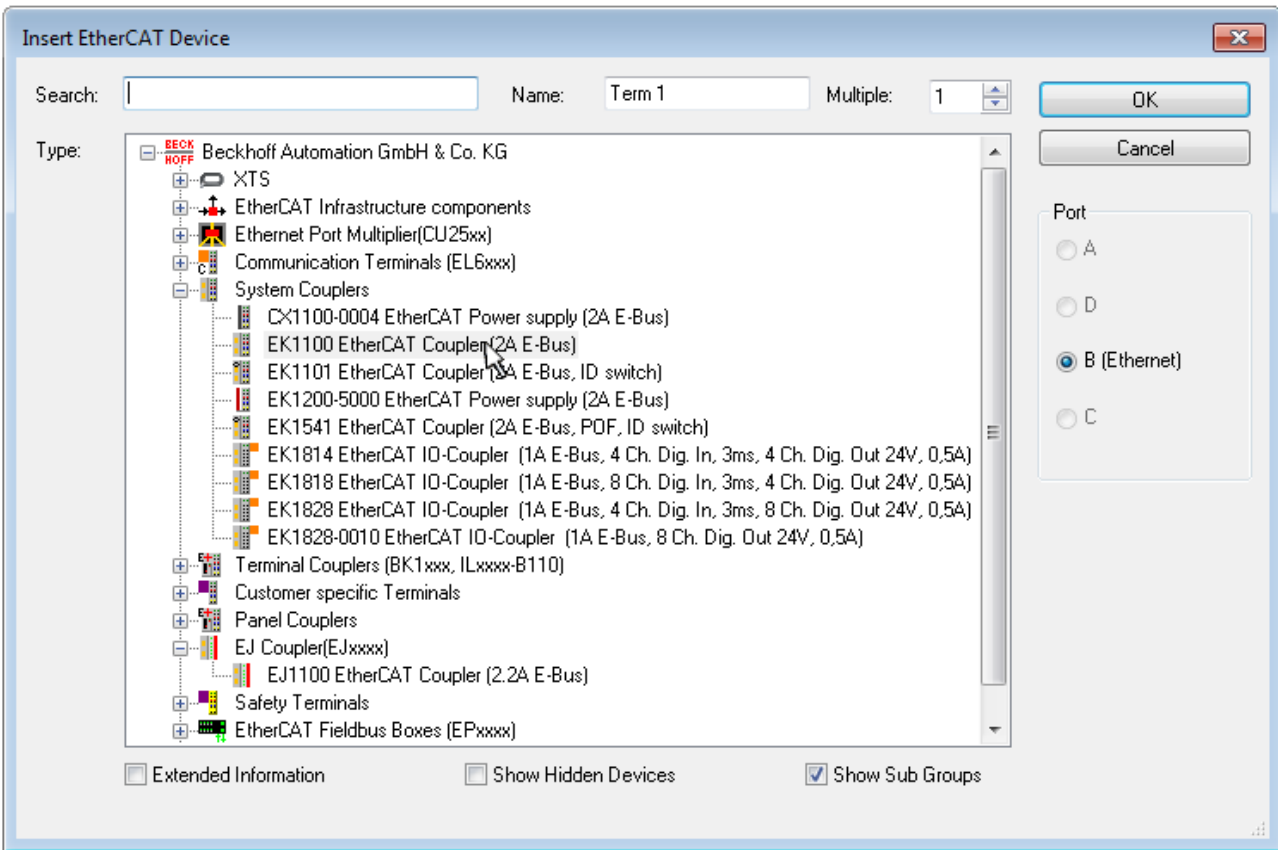

Fig. 103: Selection dialog for new EtherCAT device

By default only the name/device type is used as selection criterion. For selecting a specific revision of the device the revision can be displayed as “Extended Information”.

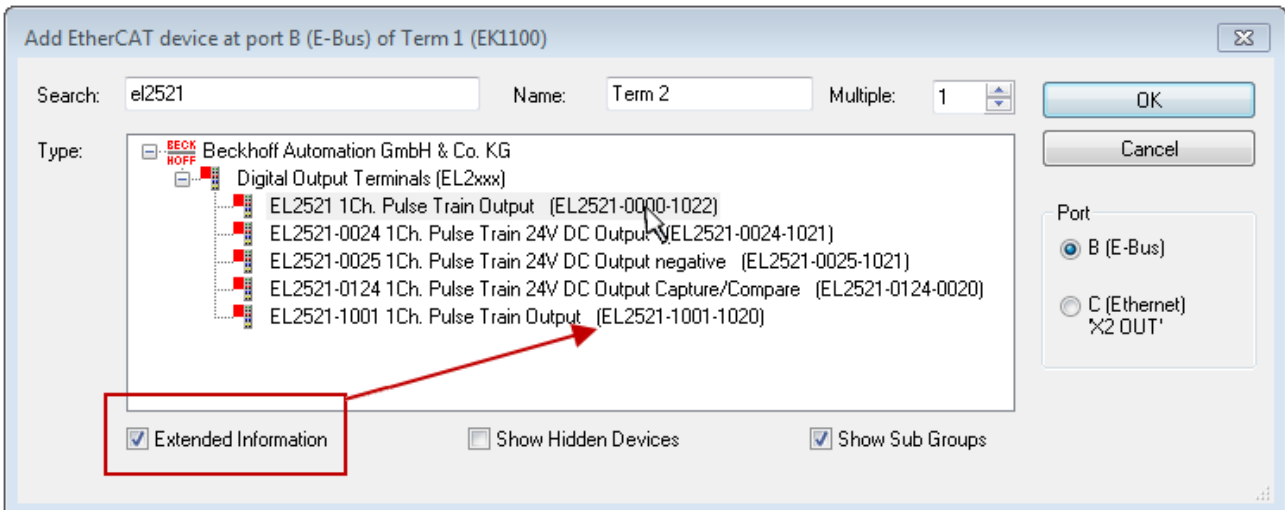

Fig. 104: Display of device revision

In many cases several device revisions were created for historic or functional reasons, e.g. through technological advancement. For simplification purposes (see Fig. “Selection dialog for new EtherCAT device”) only the last (i.e. highest) revision and therefore the latest state of production is displayed in the selection dialog for Beckhoff devices. To show all device revisions available in the system as ESI descriptions tick the “Show Hidden Devices” check box, see Fig. “Display of previous revisions”.

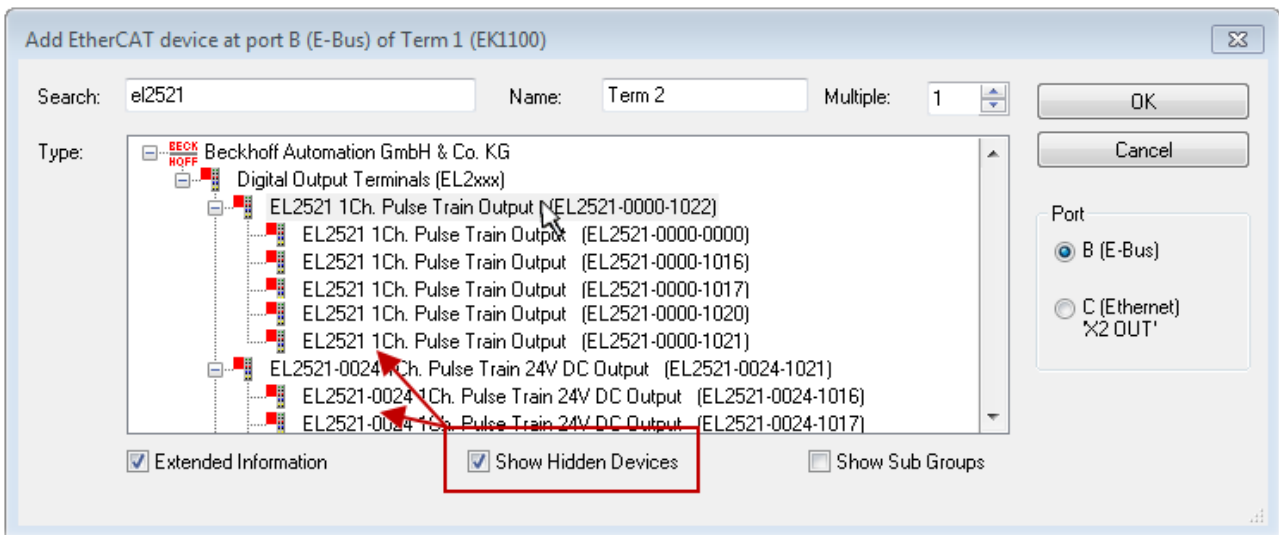

Fig. 105: Display of previous revisions

Device selection based on revision, compatibility

The ESI description also defines the process image, the communication type between master and slave/device and the device functions, if applicable. The physical device (firmware, if available) has to support the communication queries/settings of the master. This is backward compatible, i.e. newer devices (higher revision) should be supported if the EtherCAT master addresses them as an older revision. The following compatibility rule of thumb is to be assumed for Beckhoff EtherCAT Terminals/ Boxes/ EJ-modules:

device revision in the system >= device revision in the configuration

This also enables subsequent replacement of devices without changing the configuration (different specifications are possible for drives).

Example:

If an EL2521-0025-1018 is specified in the configuration, an EL2521-0025-1018 or higher (-1019, -1020) can be used in practice.

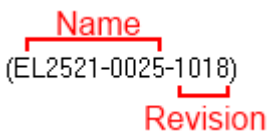

Fig. 106: Name/revision of the terminal

If current ESI descriptions are available in the TwinCAT system, the last revision offered in the selection dialog matches the Beckhoff state of production. It is recommended to use the last device revision when creating a new configuration, if current Beckhoff devices are used in the real application. Older revisions should only be used if older devices from stock are to be used in the application.

In this case the process image of the device is shown in the configuration tree and can be parameterised as follows: linking with the task, CoE/DC settings, plug-in definition, startup settings, ...

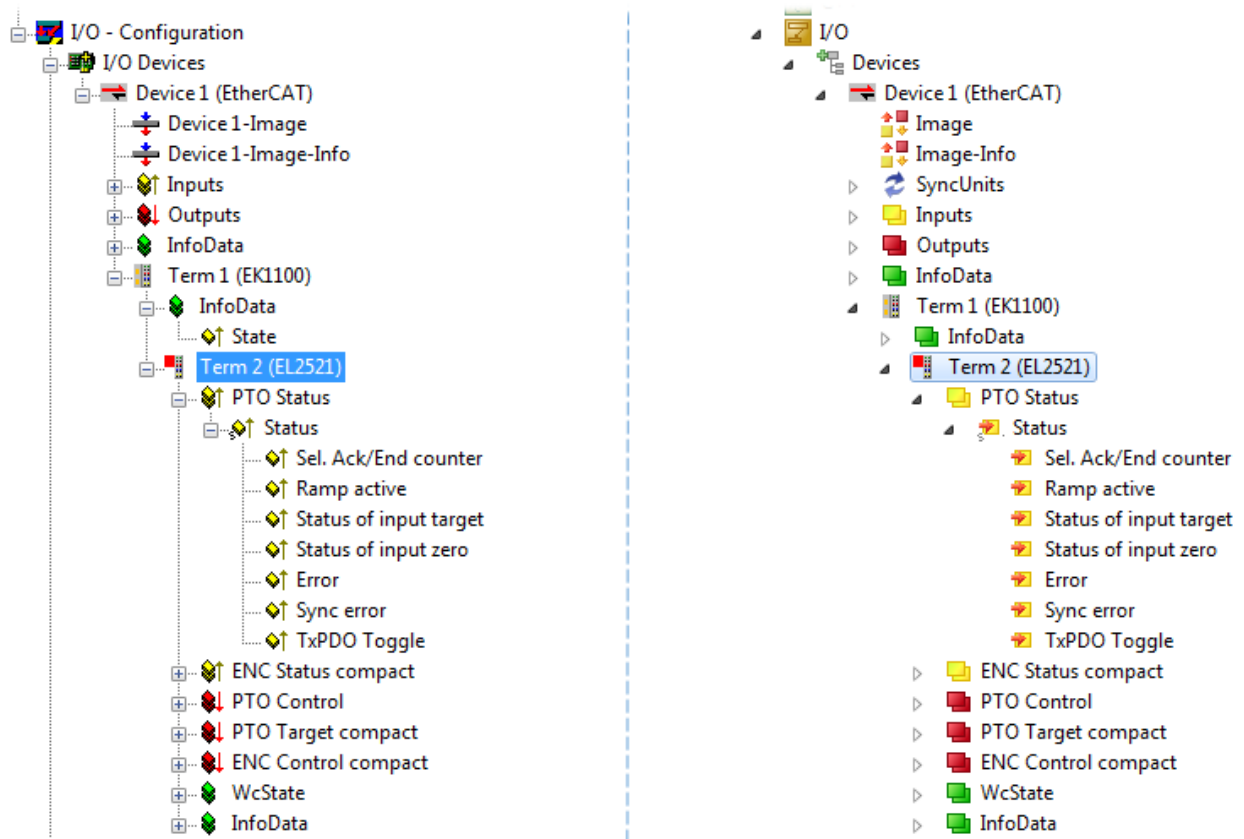



Fig. 107: EtherCAT terminal in the TwinCAT tree (left: TwinCAT 2; right: TwinCAT 3)



5.2.6 ONLINE configuration creation

Detecting/scanning of the EtherCAT device

The online device search can be used if the TwinCAT system is in CONFIG mode. This can be indicated by a symbol right below in the information bar:



- on TwinCAT 2 by a blue display “Config Mode” within the System Manager window:  .
- on TwinCAT 3 within the user interface of the development environment by a symbol  .

TwinCAT can be set into this mode:

- TwinCAT 2: by selection of  in the Menubar or by “Actions” → “Set/Reset TwinCAT to Config Mode...”
- TwinCAT 3: by selection of  in the Menubar or by „TwinCAT“ → “Restart TwinCAT (Config Mode)”

● Online scanning in Config mode

i The online search is not available in RUN mode (production operation). Note the differentiation between TwinCAT programming system and TwinCAT target system.

The TwinCAT 2 icon () or TwinCAT 3 icon () within the Windows-Taskbar always shows the TwinCAT mode of the local IPC. Compared to that, the System Manager window of TwinCAT 2 or the user interface of TwinCAT 3 indicates the state of the target system.

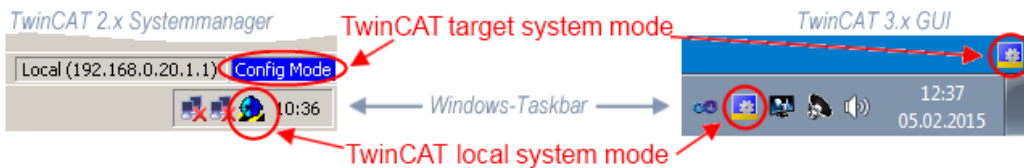

Fig. 108: Differentiation local/target system (left: TwinCAT 2; right: TwinCAT 3)

Right-clicking on “I/O Devices” in the configuration tree opens the search dialog.

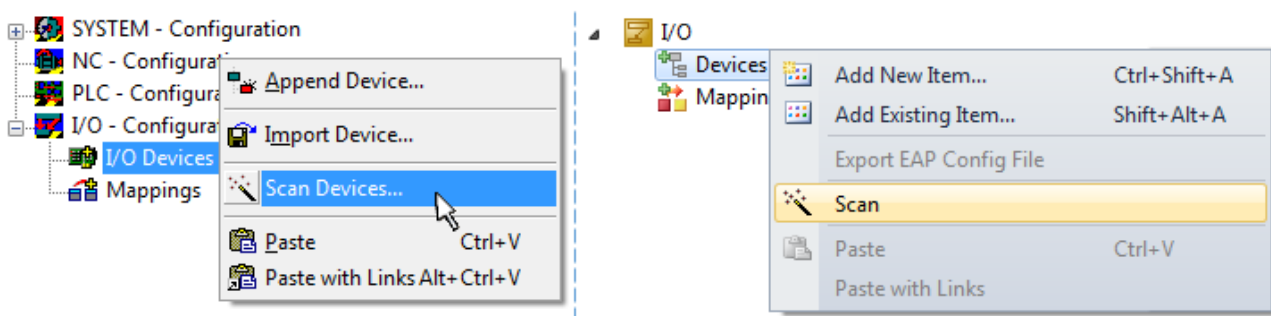

Fig. 109: Scan Devices (left: TwinCAT 2; right: TwinCAT 3)

This scan mode attempts to find not only EtherCAT devices (or Ethernet ports that are usable as such), but also NOVRAM, fieldbus cards, SMB etc. However, not all devices can be found automatically.

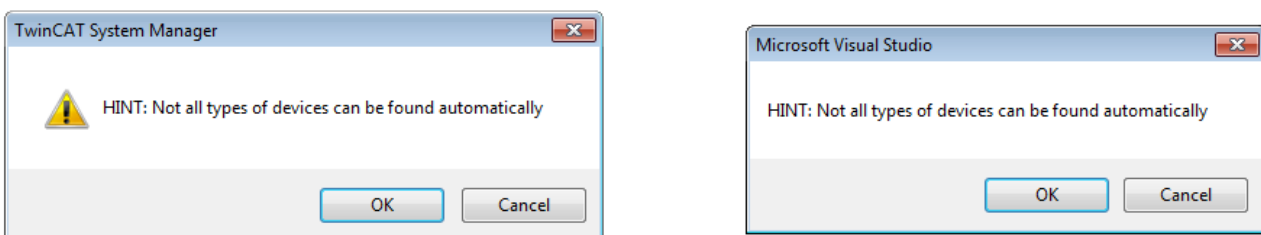

Fig. 110: Note for automatic device scan (left: TwinCAT 2; right: TwinCAT 3)

Ethernet ports with installed TwinCAT real-time driver are shown as “RT Ethernet” devices. An EtherCAT frame is sent to these ports for testing purposes. If the scan agent detects from the response that an EtherCAT slave is connected, the port is immediately shown as an “EtherCAT Device” .

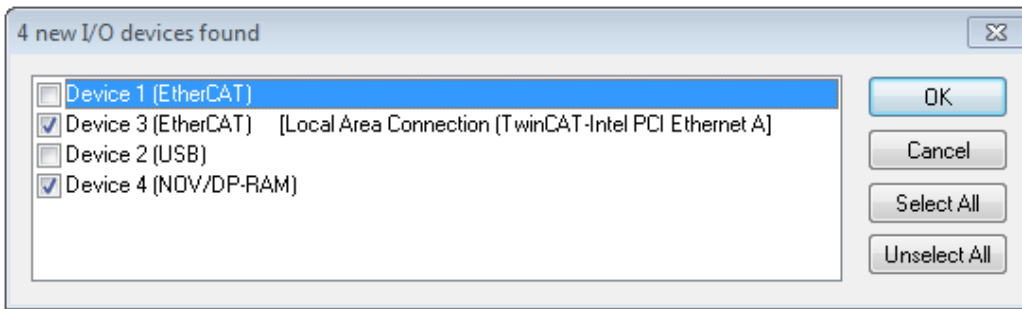

Fig. 111: *Detected Ethernet devices*

Via respective checkboxes devices can be selected (as illustrated in Fig. “*Detected Ethernet devices*” e.g. Device 3 and Device 4 were chosen). After confirmation with “OK” a device scan is suggested for all selected devices, see Fig.: “*Scan query after automatic creation of an EtherCAT device*”.

● Selecting the Ethernet port



Ethernet ports can only be selected for EtherCAT devices for which the TwinCAT real-time driver is installed. This has to be done separately for each port. Please refer to the respective [installation page \[▶ 87\]](#).

Detecting/Scanning the EtherCAT devices

● Online scan functionality



During a scan the master queries the identity information of the EtherCAT slaves from the slave EEPROM. The name and revision are used for determining the type. The respective devices are located in the stored ESI data and integrated in the configuration tree in the default state defined there.

Name
(EL2521-0025-1018)
Revision

Fig. 112: *Example default state*

NOTE

Slave scanning in practice in series machine production

The scanning function should be used with care. It is a practical and fast tool for creating an initial configuration as a basis for commissioning. In series machine production or reproduction of the plant, however, the function should no longer be used for the creation of the configuration, but if necessary for [comparison \[▶ 108\]](#) with the defined initial configuration. Background: since Beckhoff occasionally increases the revision version of the delivered products for product maintenance reasons, a configuration can be created by such a scan which (with an identical machine construction) is identical according to the device list; however, the respective device revision may differ from the initial configuration.

Example:

Company A builds the prototype of a machine B, which is to be produced in series later on. To do this the prototype is built, a scan of the IO devices is performed in TwinCAT and the initial configuration ‘B.tsm’ is created. The EL2521-0025 EtherCAT terminal with the revision 1018 is located somewhere. It is thus built into the TwinCAT configuration in this way:

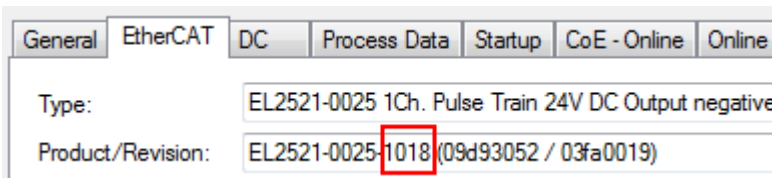

Fig. 113: Installing EtherCAT terminal with revision -1018

Likewise, during the prototype test phase, the functions and properties of this terminal are tested by the programmers/commissioning engineers and used if necessary, i.e. addressed from the PLC 'B.pro' or the NC. (the same applies correspondingly to the TwinCAT 3 solution files).

The prototype development is now completed and series production of machine B starts, for which Beckhoff continues to supply the EL2521-0025-0018. If the commissioning engineers of the series machine production department always carry out a scan, a B configuration with the identical contents results again for each machine. Likewise, A might create spare parts stores worldwide for the coming series-produced machines with EL2521-0025-1018 terminals.

After some time Beckhoff extends the EL2521-0025 by a new feature C. Therefore the FW is changed, outwardly recognizable by a higher FW version and a **new revision -1019**. Nevertheless the new device naturally supports functions and interfaces of the predecessor version(s); an adaptation of 'B.tsm' or even 'B.pro' is therefore unnecessary. The series-produced machines can continue to be built with 'B.tsm' and 'B.pro'; it makes sense to perform a comparative scan [▶ 108] against the initial configuration 'B.tsm' in order to check the built machine.

However, if the series machine production department now doesn't use 'B.tsm', but instead carries out a scan to create the productive configuration, the revision **-1019** is automatically detected and built into the configuration:

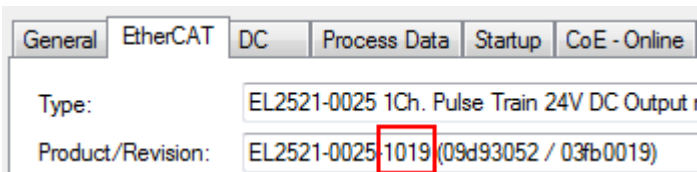

Fig. 114: Detection of EtherCAT terminal with revision -1019

This is usually not noticed by the commissioning engineers. TwinCAT cannot signal anything either, since virtually a new configuration is created. According to the compatibility rule, however, this means that no EL2521-0025-1018 should be built into this machine as a spare part (even if this nevertheless works in the vast majority of cases).

In addition, it could be the case that, due to the development accompanying production in company A, the new feature C of the EL2521-0025-1019 (for example, an improved analog filter or an additional process data for the diagnosis) is discovered and used without in-house consultation. The previous stock of spare part devices are then no longer to be used for the new configuration 'B2.tsm' created in this way. If series machine production is established, the scan should only be performed for informative purposes for comparison with a defined initial configuration. Changes are to be made with care!

If an EtherCAT device was created in the configuration (manually or through a scan), the I/O field can be scanned for devices/slaves.



Fig. 115: Scan query after automatic creation of an EtherCAT device (left: TwinCAT 2; right: TwinCAT 3)

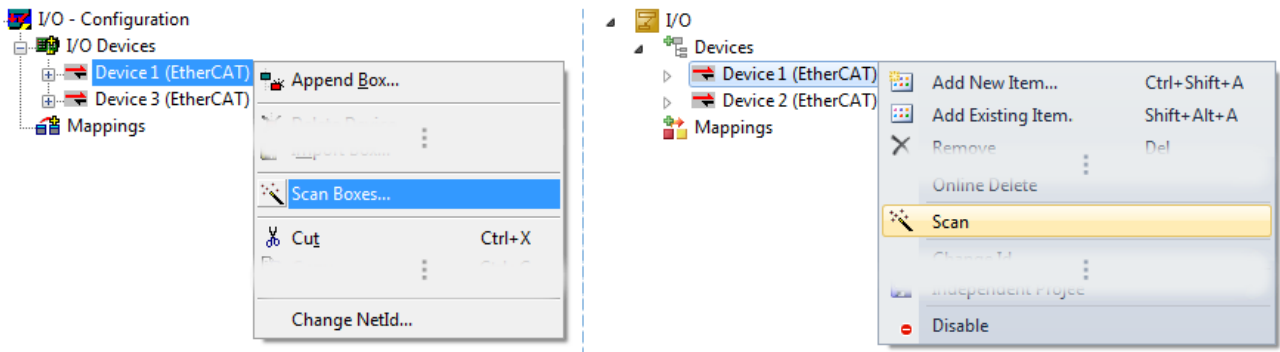

Fig. 116: Manual triggering of a device scan on a specified EtherCAT device (left: TwinCAT 2; right: TwinCAT 3)

In the System Manager (TwinCAT 2) or the User Interface (TwinCAT 3) the scan process can be monitored via the progress bar at the bottom in the status bar.



Fig. 117: Scan progress exemplary by TwinCAT 2

The configuration is established and can then be switched to online state (OPERATIONAL).



Fig. 118: Config/FreeRun query (left: TwinCAT 2; right: TwinCAT 3)

In Config/FreeRun mode the System Manager display alternates between blue and red, and the EtherCAT device continues to operate with the idling cycle time of 4 ms (default setting), even without active task (NC, PLC).



Fig. 119: Displaying of “Free Run” and “Config Mode” toggling right below in the status bar



Fig. 120: TwinCAT can also be switched to this state by using a button (left: TwinCAT 2; right: TwinCAT 3)

The EtherCAT system should then be in a functional cyclic state, as shown in Fig. “Online display example”.

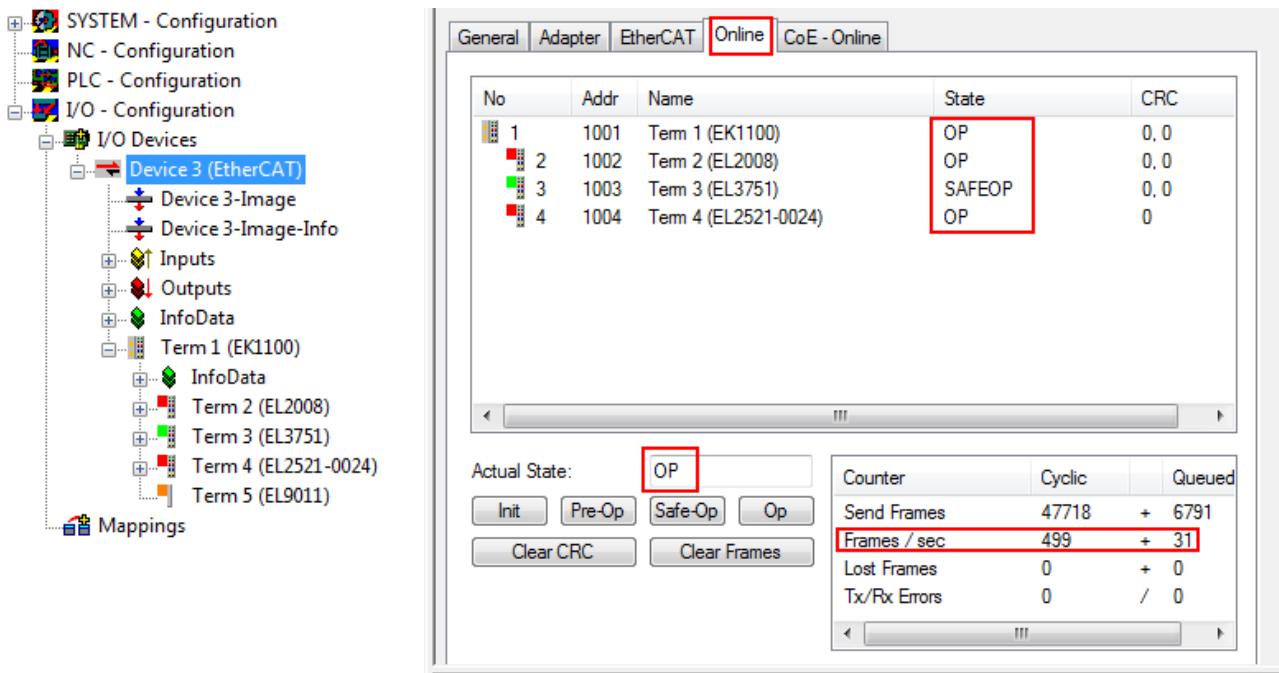

Fig. 121: Online display example

Please note:

- all slaves should be in OP state
- the EtherCAT master should be in “Actual State” OP
- “frames/sec” should match the cycle time taking into account the sent number of frames
- no excessive “LostFrames” or CRC errors should occur

The configuration is now complete. It can be modified as described under [manual procedure \[► 98\]](#).

Troubleshooting

Various effects may occur during scanning.

- An **unknown device** is detected, i.e. an EtherCAT slave for which no ESI XML description is available. In this case the System Manager offers to read any ESI that may be stored in the device. This case is described in the chapter "Notes regarding ESI device description".
- **Device are not detected properly**
Possible reasons include:
 - faulty data links, resulting in data loss during the scan
 - slave has invalid device description
 The connections and devices should be checked in a targeted manner, e.g. via the emergency scan. Then re-run the scan.

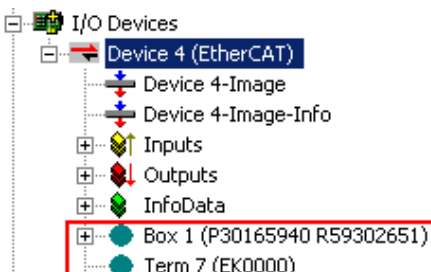

Fig. 122: Faulty identification

In the System Manager such devices may be set up as EK0000 or unknown devices. Operation is not possible or meaningful.

Scan over existing Configuration

NOTE

Change of the configuration after comparison

With this scan (TwinCAT 2.11 or 3.1) only the device properties vendor (manufacturer), device name and revision are compared at present! A 'ChangeTo' or 'Copy' should only be carried out with care, taking into consideration the Beckhoff IO compatibility rule (see above). The device configuration is then replaced by the revision found; this can affect the supported process data and functions.

If a scan is initiated for an existing configuration, the actual I/O environment may match the configuration exactly or it may differ. This enables the configuration to be compared.



Fig. 123: Identical configuration (left: TwinCAT 2; right: TwinCAT 3)

If differences are detected, they are shown in the correction dialog, so that the user can modify the configuration as required.

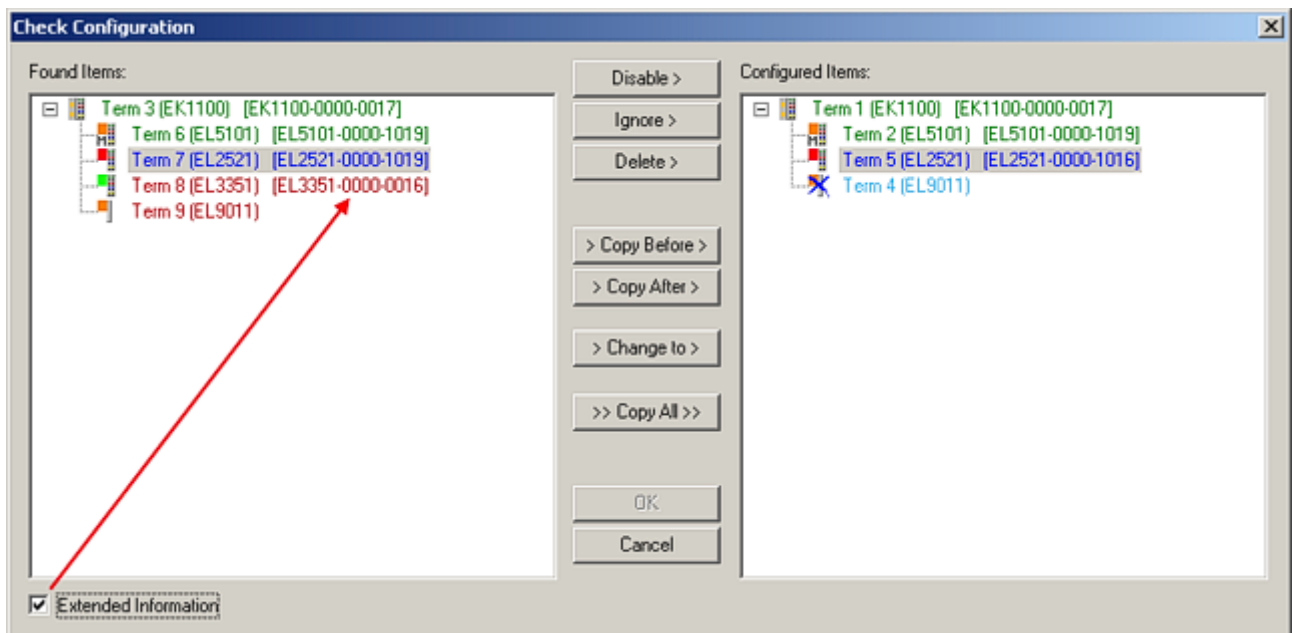

Fig. 124: Correction dialog

It is advisable to tick the "Extended Information" check box to reveal differences in the revision.

Colour	Explanation
green	This EtherCAT slave matches the entry on the other side. Both type and revision match.
blue	This EtherCAT slave is present on the other side, but in a different revision. This other revision can have other default values for the process data as well as other/additional functions. If the found revision is higher than the configured revision, the slave may be used provided compatibility issues are taken into account. If the found revision is lower than the configured revision, it is likely that the slave cannot be used. The found device may not support all functions that the master expects based on the higher revision number.
light blue	This EtherCAT slave is ignored ("Ignore" button)
red	<ul style="list-style-type: none"> This EtherCAT slave is not present on the other side. It is present, but in a different revision, which also differs in its properties from the one specified. The compatibility principle then also applies here: if the found revision is higher than the configured revision, use is possible provided compatibility issues are taken into account, since the successor devices should support the functions of the predecessor devices. If the found revision is lower than the configured revision, it is likely that the slave cannot be used. The found device may not support all functions that the master expects based on the higher revision number.

● Device selection based on revision, compatibility

i The ESI description also defines the process image, the communication type between master and slave/device and the device functions, if applicable. The physical device (firmware, if available) has to support the communication queries/settings of the master. This is backward compatible, i.e. newer devices (higher revision) should be supported if the EtherCAT master addresses them as an older revision. The following compatibility rule of thumb is to be assumed for Beckhoff EtherCAT Terminals/ Boxes/ EJ-modules:

device revision in the system >= device revision in the configuration

This also enables subsequent replacement of devices without changing the configuration (different specifications are possible for drives).

Example:

If an EL2521-0025-**1018** is specified in the configuration, an EL2521-0025-**1018** or higher (**-1019**, **-1020**) can be used in practice.

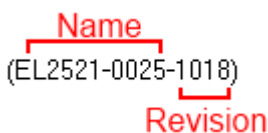

Fig. 125: Name/revision of the terminal

If current ESI descriptions are available in the TwinCAT system, the last revision offered in the selection dialog matches the Beckhoff state of production. It is recommended to use the last device revision when creating a new configuration, if current Beckhoff devices are used in the real application. Older revisions should only be used if older devices from stock are to be used in the application.

In this case the process image of the device is shown in the configuration tree and can be parameterised as follows: linking with the task, CoE/DC settings, plug-in definition, startup settings, ...

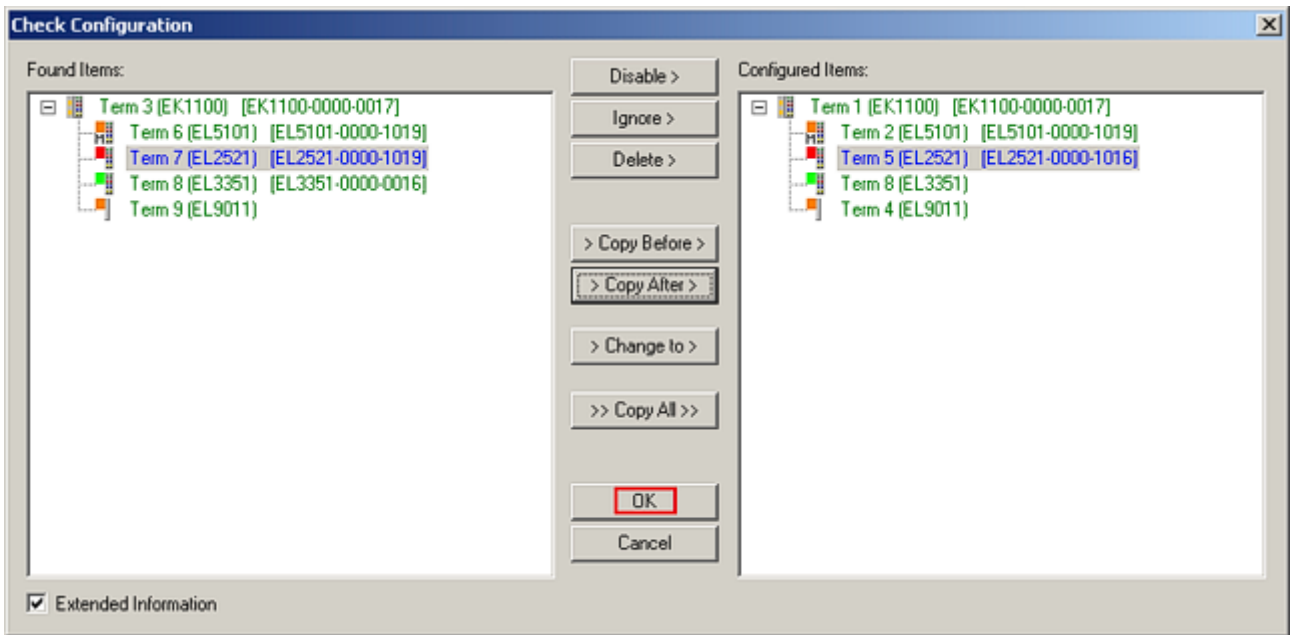

Fig. 126: Correction dialog with modifications

Once all modifications have been saved or accepted, click “OK” to transfer them to the real *.tsm configuration.

Change to Compatible Type

TwinCAT offers a function “Change to Compatible Type...” for the exchange of a device whilst retaining the links in the task.

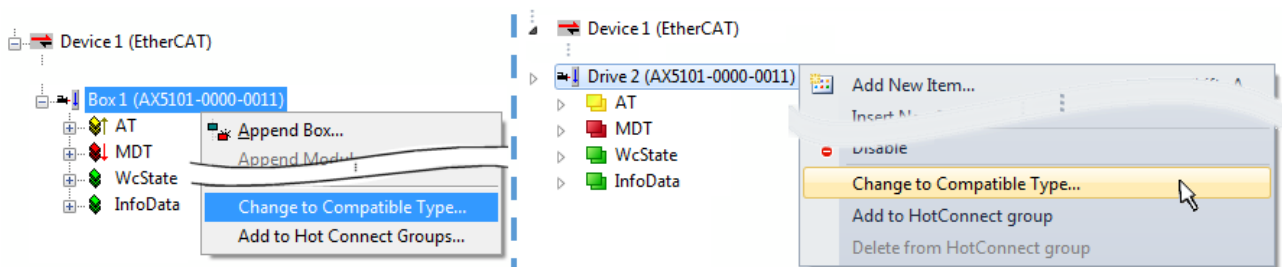

Fig. 127: Dialog “Change to Compatible Type...” (left: TwinCAT 2; right: TwinCAT 3)

This function is preferably to be used on AX5000 devices.

Change to Alternative Type

The TwinCAT System Manager offers a function for the exchange of a device: *Change to Alternative Type*

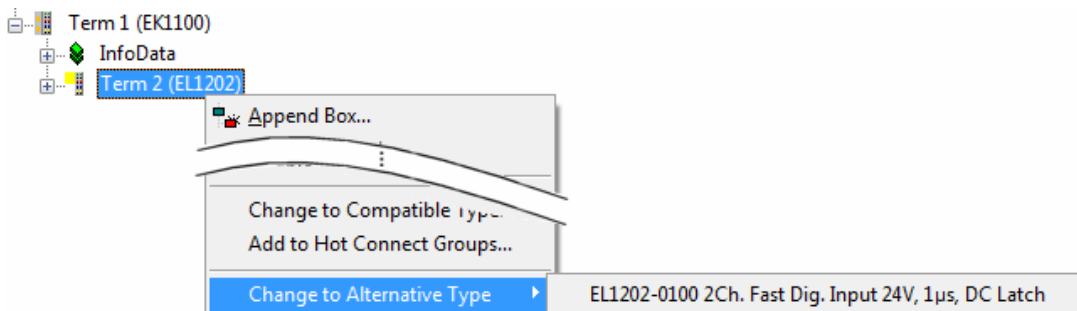

Fig. 128: TwinCAT 2 Dialog Change to Alternative Type

If called, the System Manager searches in the procured device ESI (in this example: EL1202-0000) for details of compatible devices contained there. The configuration is changed and the ESI-EEPROM is overwritten at the same time – therefore this process is possible only in the online state (ConfigMode).

5.2.7 EtherCAT subscriber configuration

In the left-hand window of the TwinCAT 2 System Manager or the Solution Explorer of the TwinCAT 3 Development Environment respectively, click on the element of the terminal within the tree you wish to configure (in the example: EL3751 Terminal 3).

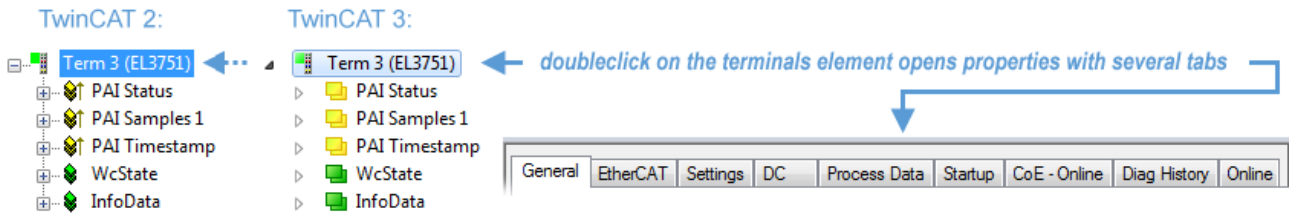

Fig. 129: Branch element as terminal EL3751

In the right-hand window of the TwinCAT System manager (TwinCAT 2) or the Development Environment (TwinCAT 3), various tabs are now available for configuring the terminal. And yet the dimension of complexity of a subscriber determines which tabs are provided. Thus as illustrated in the example above the terminal EL3751 provides many setup options and also a respective number of tabs are available. On the contrary by the terminal EL1004 for example the tabs "General", "EtherCAT", "Process Data" and "Online" are available only. Several terminals, as for instance the EL6695 provide special functions by a tab with its own terminal name, so "EL6695" in this case. A specific tab "Settings" by terminals with a wide range of setup options will be provided also (e.g. EL3751).

„General“ tab

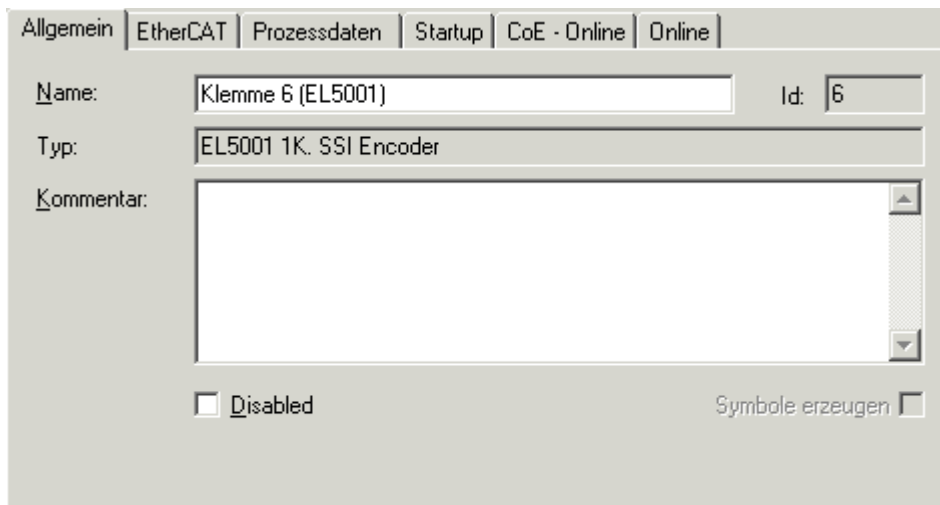

Fig. 130: "General" tab

Name	Name of the EtherCAT device
Id	Number of the EtherCAT device
Type	EtherCAT device type
Comment	Here you can add a comment (e.g. regarding the system).
Disabled	Here you can deactivate the EtherCAT device.
Create symbols	Access to this EtherCAT slave via ADS is only available if this control box is activated.

„EtherCAT“ tab

The screenshot shows a software configuration window for an EtherCAT device. The 'EtherCAT' tab is active, showing the following configuration:

- Typ:** EL5001 1K. SSI Encoder
- Produkt / Revision:** EL5001-0000-0000
- Auto-Inc-Adresse:** FFF8
- EtherCAT-Adresse:** 1006 Weitere Einstellungen...
- Vorgänger-Port:** Klemme 5 (EL5001) - B

A URL is provided at the bottom: <http://www.beckhoff.de/german/default.htm?EtherCAT/EL5001.htm>

Fig. 131: „EtherCAT“ tab

Type

EtherCAT device type

Product/Revision

Product and revision number of the EtherCAT device

Auto Inc Addr.

Auto increment address of the EtherCAT device. The auto increment address can be used for addressing each EtherCAT device in the communication ring through its physical position. Auto increment addressing is used during the start-up phase when the EtherCAT master allocates addresses to the EtherCAT devices. With auto increment addressing the first EtherCAT slave in the ring has the address 0000_{hex} . For each further slave the address is decremented by 1 ($FFFF_{\text{hex}}$, $FFFE_{\text{hex}}$ etc.).

EtherCAT Addr.

Fixed address of an EtherCAT slave. This address is allocated by the EtherCAT master during the start-up phase. Tick the control box to the left of the input field in order to modify the default value.

Previous Port

Name and port of the EtherCAT device to which this device is connected. If it is possible to connect this device with another one without changing the order of the EtherCAT devices in the communication ring, then this combination field is activated and the EtherCAT device to which this device is to be connected can be selected.

Advanced Settings

This button opens the dialogs for advanced settings.

The link at the bottom of the tab points to the product page for this EtherCAT device on the web.

“Process Data” tab

Indicates the configuration of the process data. The input and output data of the EtherCAT slave are represented as CANopen process data objects (Process Data Objects, PDOs). The user can select a PDO via PDO assignment and modify the content of the individual PDO via this dialog, if the EtherCAT slave supports this function.

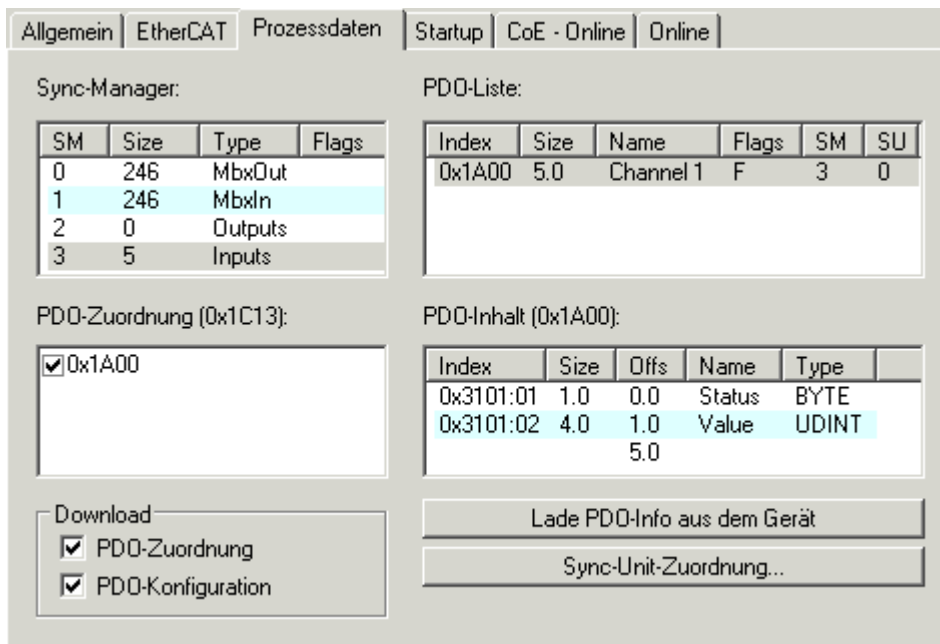

Fig. 132: "Process Data" tab

The process data (PDOs) transferred by an EtherCAT slave during each cycle are user data which the application expects to be updated cyclically or which are sent to the slave. To this end the EtherCAT master (Beckhoff TwinCAT) parameterizes each EtherCAT slave during the start-up phase to define which process data (size in bits/bytes, source location, transmission type) it wants to transfer to or from this slave. Incorrect configuration can prevent successful start-up of the slave.

For Beckhoff EtherCAT EL, ES, EM, EJ and EP slaves the following applies in general:

- The input/output process data supported by the device are defined by the manufacturer in the ESI/XML description. The TwinCAT EtherCAT Master uses the ESI description to configure the slave correctly.
- The process data can be modified in the system manager. See the device documentation. Examples of modifications include: mask out a channel, displaying additional cyclic information, 16-bit display instead of 8-bit data size, etc.
- In so-called "intelligent" EtherCAT devices the process data information is also stored in the CoE directory. Any changes in the CoE directory that lead to different PDO settings prevent successful startup of the slave. It is not advisable to deviate from the designated process data, because the device firmware (if available) is adapted to these PDO combinations.

If the device documentation allows modification of process data, proceed as follows (see Figure "Configuring the process data").

- A: select the device to configure
- B: in the "Process Data" tab select Input or Output under SyncManager (C)
- D: the PDOs can be selected or deselected
- H: the new process data are visible as linkable variables in the system manager
The new process data are active once the configuration has been activated and TwinCAT has been restarted (or the EtherCAT master has been restarted)
- E: if a slave supports this, Input and Output PDO can be modified simultaneously by selecting a so-called PDO record ("predefined PDO settings").

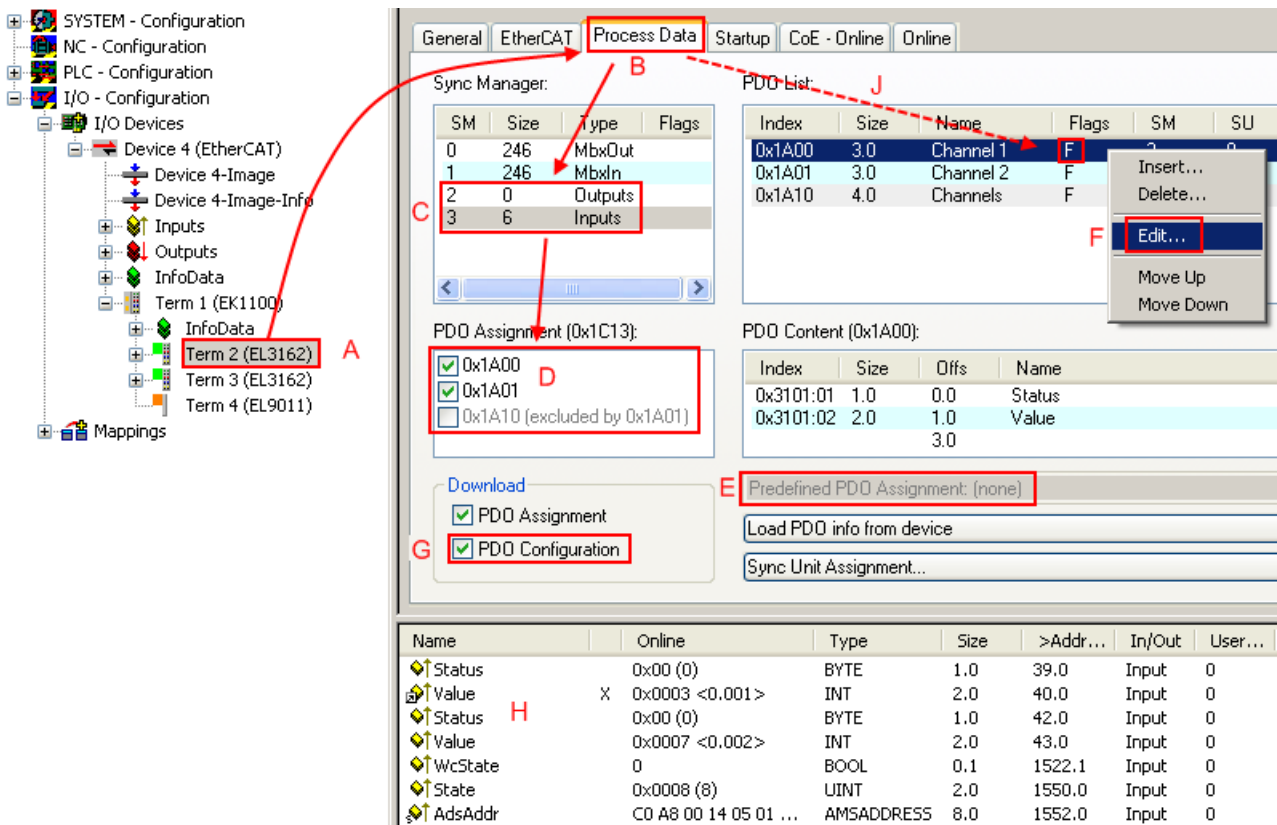

Fig. 133: Configuring the process data

Manual modification of the process data

According to the ESI description, a PDO can be identified as “fixed” with the flag “F” in the PDO overview (Fig. “Configuring the process data”, J). The configuration of such PDOs cannot be changed, even if TwinCAT offers the associated dialog (“Edit”). In particular, CoE content cannot be displayed as cyclic process data. This generally also applies in cases where a device supports download of the PDO configuration, “G”. In case of incorrect configuration the EtherCAT slave usually refuses to start and change to OP state. The System Manager displays an “invalid SM cfg” log-ger message: This error message (“invalid SM IN cfg” or “invalid SM OUT cfg”) also indicates the reason for the failed start.

A detailed description [► 119] can be found at the end of this section.

„Startup“ tab

The *Startup* tab is displayed if the EtherCAT slave has a mailbox and supports the *CANopen over EtherCAT* (CoE) or *Servo drive over EtherCAT* protocol. This tab indicates which download requests are sent to the mailbox during startup. It is also possible to add new mailbox requests to the list display. The download requests are sent to the slave in the same order as they are shown in the list.

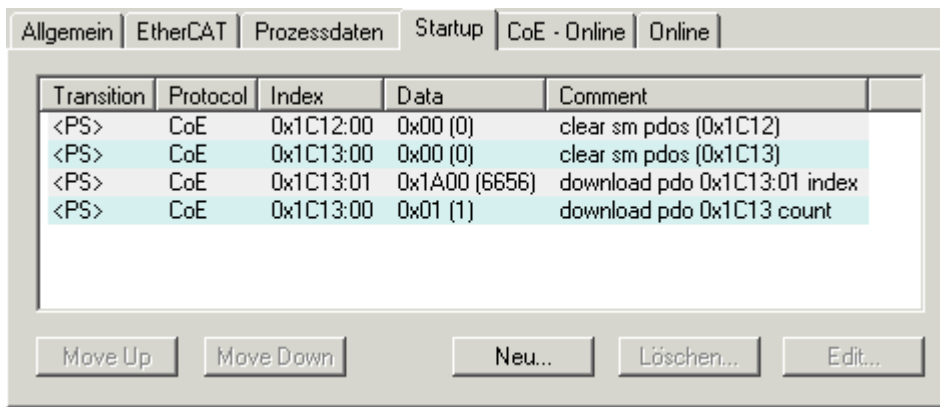

Fig. 134: „Startup“ tab

Column	Description
Transition	Transition to which the request is sent. This can either be <ul style="list-style-type: none"> the transition from pre-operational to safe-operational (PS), or the transition from safe-operational to operational (SO). If the transition is enclosed in "<>" (e.g. <PS>), the mailbox request is fixed and cannot be modified or deleted by the user.
Protocol	Type of mailbox protocol
Index	Index of the object
Data	Date on which this object is to be downloaded.
Comment	Description of the request to be sent to the mailbox

- Move Up** This button moves the selected request up by one position in the list.
- Move Down** This button moves the selected request down by one position in the list.
- New** This button adds a new mailbox download request to be sent during startup.
- Delete** This button deletes the selected entry.
- Edit** This button edits an existing request.

“CoE – Online” tab

The additional *CoE - Online* tab is displayed if the EtherCAT slave supports the *CANopen over EtherCAT* (CoE) protocol. This dialog lists the content of the object list of the slave (SDO upload) and enables the user to modify the content of an object from this list. Details for the objects of the individual EtherCAT devices can be found in the device-specific object descriptions.

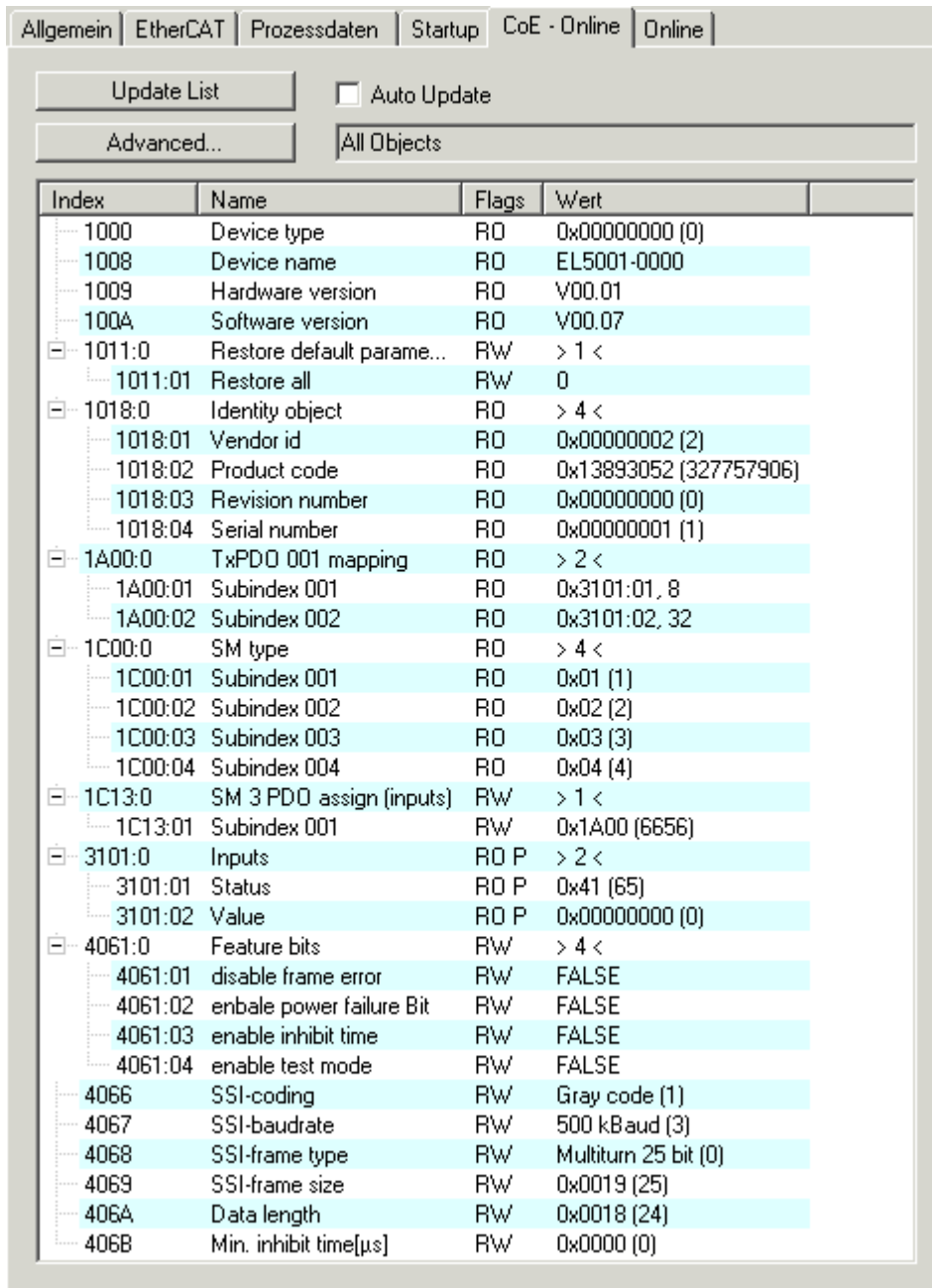

Fig. 135: “CoE – Online” tab

Object list display

Column	Description
Index	Index and sub-index of the object
Name	Name of the object
Flags	RW The object can be read, and data can be written to the object (read/write)
	RO The object can be read, but no data can be written to the object (read only)
	P An additional P identifies the object as a process data object.
Value	Value of the object

- Update List** The *Update list* button updates all objects in the displayed list
- Auto Update** If this check box is selected, the content of the objects is updated automatically.
- Advanced** The *Advanced* button opens the *Advanced Settings* dialog. Here you can specify which objects are displayed in the list.

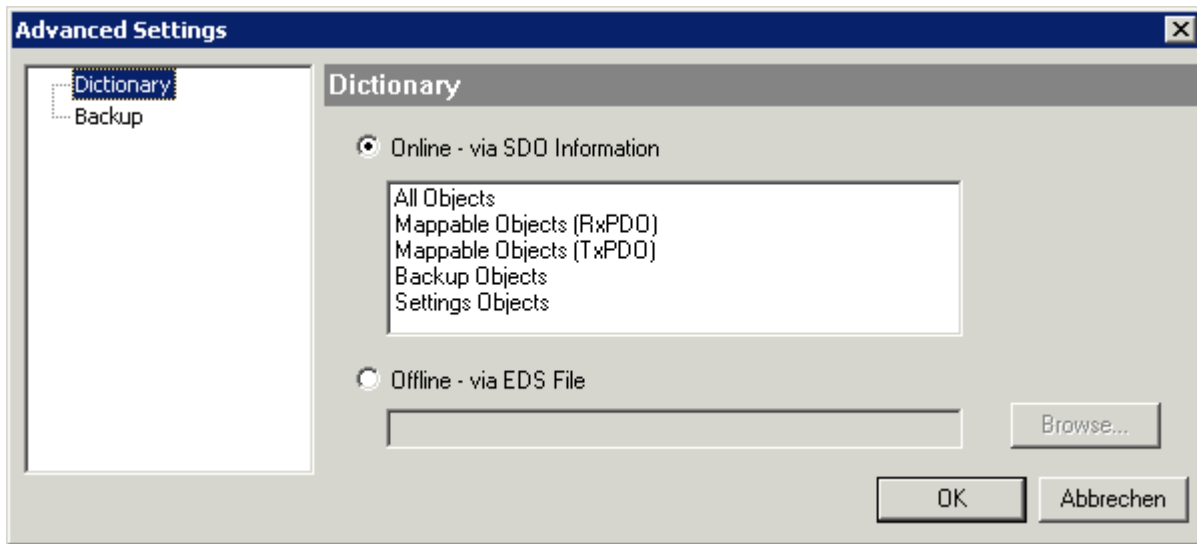

Fig. 136: Dialog “Advanced settings”

Online - via SDO Information If this option button is selected, the list of the objects included in the object list of the slave is uploaded from the slave via SDO information. The list below can be used to specify which object types are to be uploaded.

Offline - via EDS File If this option button is selected, the list of the objects included in the object list is read from an EDS file provided by the user.

„Online“ tab

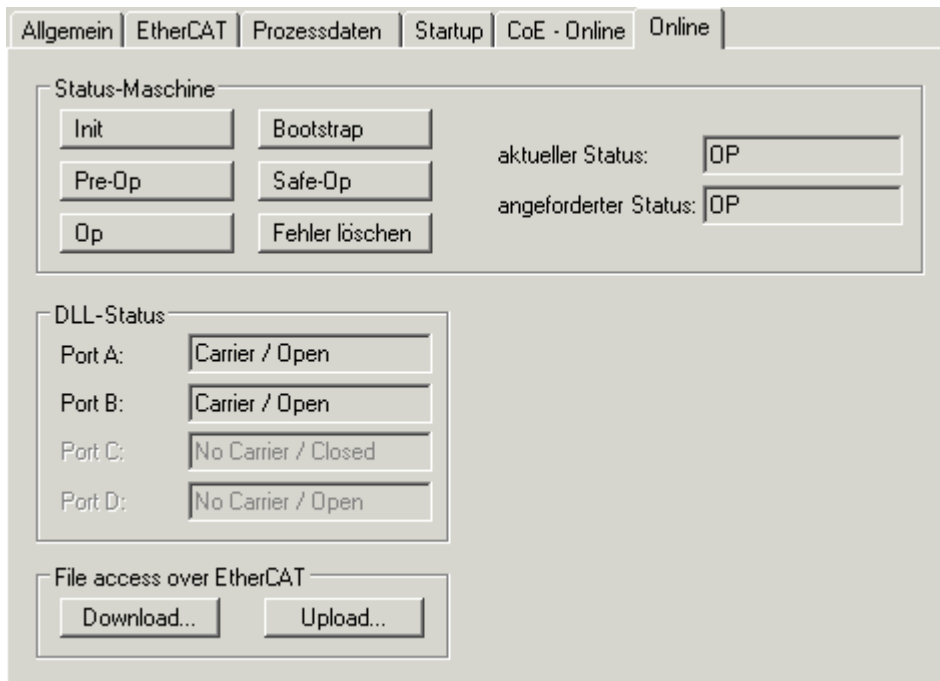

Fig. 137: „Online“ tab

State Machine

Init	This button attempts to set the EtherCAT device to the <i>Init</i> state.
Pre-Op	This button attempts to set the EtherCAT device to the <i>pre-operational</i> state.
Op	This button attempts to set the EtherCAT device to the <i>operational</i> state.
Bootstrap	This button attempts to set the EtherCAT device to the <i>Bootstrap</i> state.
Safe-Op	This button attempts to set the EtherCAT device to the <i>safe-operational</i> state.
Clear Error	This button attempts to delete the fault display. If an EtherCAT slave fails during change of state it sets an error flag. Example: An EtherCAT slave is in PREOP state (pre-operational). The master now requests the SAFEOP state (safe-operational). If the slave fails during change of state it sets the error flag. The current state is now displayed as ERR PREOP. When the <i>Clear Error</i> button is pressed the error flag is cleared, and the current state is displayed as PREOP again.
Current State	Indicates the current state of the EtherCAT device.
Requested State	Indicates the state requested for the EtherCAT device.

DLL Status

Indicates the DLL status (data link layer status) of the individual ports of the EtherCAT slave. The DLL status can have four different states:

Status	Description
No Carrier / Open	No carrier signal is available at the port, but the port is open.
No Carrier / Closed	No carrier signal is available at the port, and the port is closed.
Carrier / Open	A carrier signal is available at the port, and the port is open.
Carrier / Closed	A carrier signal is available at the port, but the port is closed.

File Access over EtherCAT

Download	With this button a file can be written to the EtherCAT device.
Upload	With this button a file can be read from the EtherCAT device.

"DC" tab (Distributed Clocks)

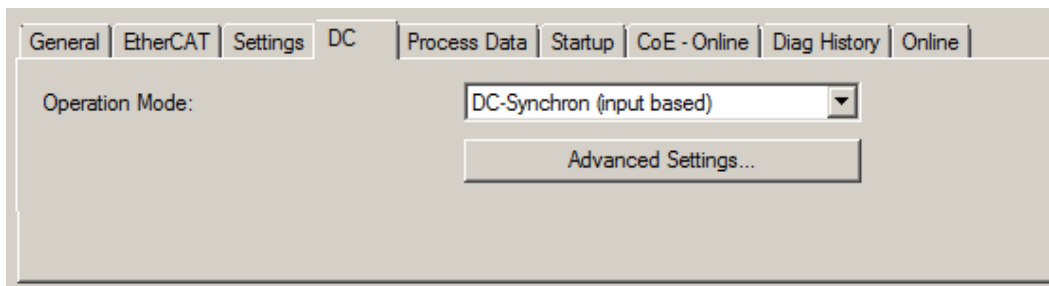

Fig. 138: "DC" tab (Distributed Clocks)

Operation Mode	Options (optional): <ul style="list-style-type: none"> • FreeRun • SM-Synchron • DC-Synchron (Input based) • DC-Synchron
Advanced Settings...	Advanced settings for readjustment of the real time determinant TwinCAT-clock

Detailed information to Distributed Clocks are specified on <http://infosys.beckhoff.com>:

Fieldbus Components → EtherCAT Terminals → EtherCAT System documentation → EtherCAT basics → Distributed Clocks

5.2.7.1 Detailed description of Process Data tab

Sync Manager

Lists the configuration of the Sync Manager (SM).

If the EtherCAT device has a mailbox, SM0 is used for the mailbox output (MbxOut) and SM1 for the mailbox input (MbxIn).

SM2 is used for the output process data (outputs) and SM3 (inputs) for the input process data.

If an input is selected, the corresponding PDO assignment is displayed in the *PDO Assignment* list below.

PDO Assignment



PDO assignment of the selected Sync Manager. All PDOs defined for this Sync Manager type are listed here:

- If the output Sync Manager (outputs) is selected in the Sync Manager list, all RxPDOs are displayed.
- If the input Sync Manager (inputs) is selected in the Sync Manager list, all TxPDOs are displayed.

The selected entries are the PDOs involved in the process data transfer. In the tree diagram of the System Manager these PDOs are displayed as variables of the EtherCAT device. The name of the variable is identical to the *Name* parameter of the PDO, as displayed in the PDO list. If an entry in the PDO assignment list is deactivated (not selected and greyed out), this indicates that the input is excluded from the PDO assignment. In order to be able to select a greyed out PDO, the currently selected PDO has to be deselected first.

● **i** Activation of PDO assignment

- ✓ If you have changed the PDO assignment, in order to activate the new PDO assignment,
 - a) the EtherCAT slave has to run through the PS status transition cycle (from pre-operational to safe-operational) once (see [Online tab \[▶ 117\]](#)),
 - b) and the System Manager has to reload the EtherCAT slaves

( button for TwinCAT 2 or  button for TwinCAT 3)

PDO list

List of all PDOs supported by this EtherCAT device. The content of the selected PDOs is displayed in the *PDO Content* list. The PDO configuration can be modified by double-clicking on an entry.

Column	Description	
Index	PDO index.	
Size	Size of the PDO in bytes.	
Name	Name of the PDO. If this PDO is assigned to a Sync Manager, it appears as a variable of the slave with this parameter as the name.	
Flags	F	Fixed content: The content of this PDO is fixed and cannot be changed by the System Manager.
	M	Mandatory PDO. This PDO is mandatory and must therefore be assigned to a Sync Manager! Consequently, this PDO cannot be deleted from the <i>PDO Assignment</i> list
SM	Sync Manager to which this PDO is assigned. If this entry is empty, this PDO does not take part in the process data traffic.	
SU	Sync unit to which this PDO is assigned.	

PDO Content

Indicates the content of the PDO. If flag F (fixed content) of the PDO is not set the content can be modified.

Download

If the device is intelligent and has a mailbox, the configuration of the PDO and the PDO assignments can be downloaded to the device. This is an optional feature that is not supported by all EtherCAT slaves.

PDO Assignment

If this check box is selected, the PDO assignment that is configured in the PDO Assignment list is downloaded to the device on startup. The required commands to be sent to the device can be viewed in the [Startup \[► 114\]](#) tab.

PDO Configuration

If this check box is selected, the configuration of the respective PDOs (as shown in the PDO list and the PDO Content display) is downloaded to the EtherCAT slave.

5.3 General Notes - EtherCAT Slave Application

This summary briefly deals with a number of aspects of EtherCAT Slave operation under TwinCAT. More detailed information on this may be found in the corresponding sections of, for instance, the [EtherCAT System Documentation](#).

Diagnosis in real time: WorkingCounter, EtherCAT State and Status

Generally speaking an EtherCAT Slave provides a variety of diagnostic information that can be used by the controlling task.

This diagnostic information relates to differing levels of communication. It therefore has a variety of sources, and is also updated at various times.

Any application that relies on I/O data from a fieldbus being correct and up to date must make diagnostic access to the corresponding underlying layers. EtherCAT and the TwinCAT System Manager offer comprehensive diagnostic elements of this kind. Those diagnostic elements that are helpful to the controlling task for diagnosis that is accurate for the current cycle when in operation (not during commissioning) are discussed below.

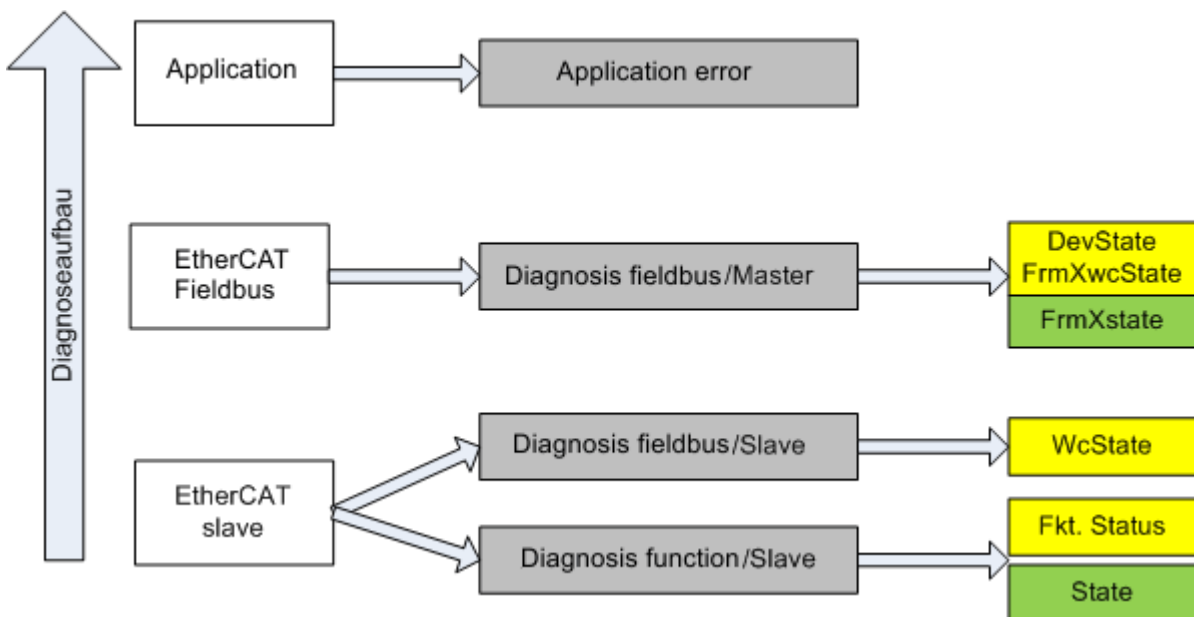

Fig. 139: Selection of the diagnostic information of an EtherCAT Slave

In general, an EtherCAT Slave offers

- communication diagnosis typical for a slave (diagnosis of successful participation in the exchange of process data, and correct operating mode)
This diagnosis is the same for all slaves.
- as well as
- function diagnosis typical for a channel (device-dependent)
See the corresponding device documentation

The colors in Fig. “Selection of the diagnostic information of an EtherCAT Slave” also correspond to the variable colors in the System Manager, see Fig. “Basic EtherCAT Slave Diagnosis in the PLC”.

Colour	Meaning
yellow	Input variables from the Slave to the EtherCAT Master, updated in every cycle
red	Output variables from the Slave to the EtherCAT Master, updated in every cycle
green	Information variables for the EtherCAT Master that are updated acyclically. This means that it is possible that in any particular cycle they do not represent the latest possible status. It is therefore useful to read such variables through ADS.

Fig. “Basic EtherCAT Slave Diagnosis in the PLC” shows an example of an implementation of basic EtherCAT Slave Diagnosis. A Beckhoff EL3102 (2-channel analogue input terminal) is used here, as it offers both the communication diagnosis typical of a slave and the functional diagnosis that is specific to a channel. Structures are created as input variables in the PLC, each corresponding to the process image.

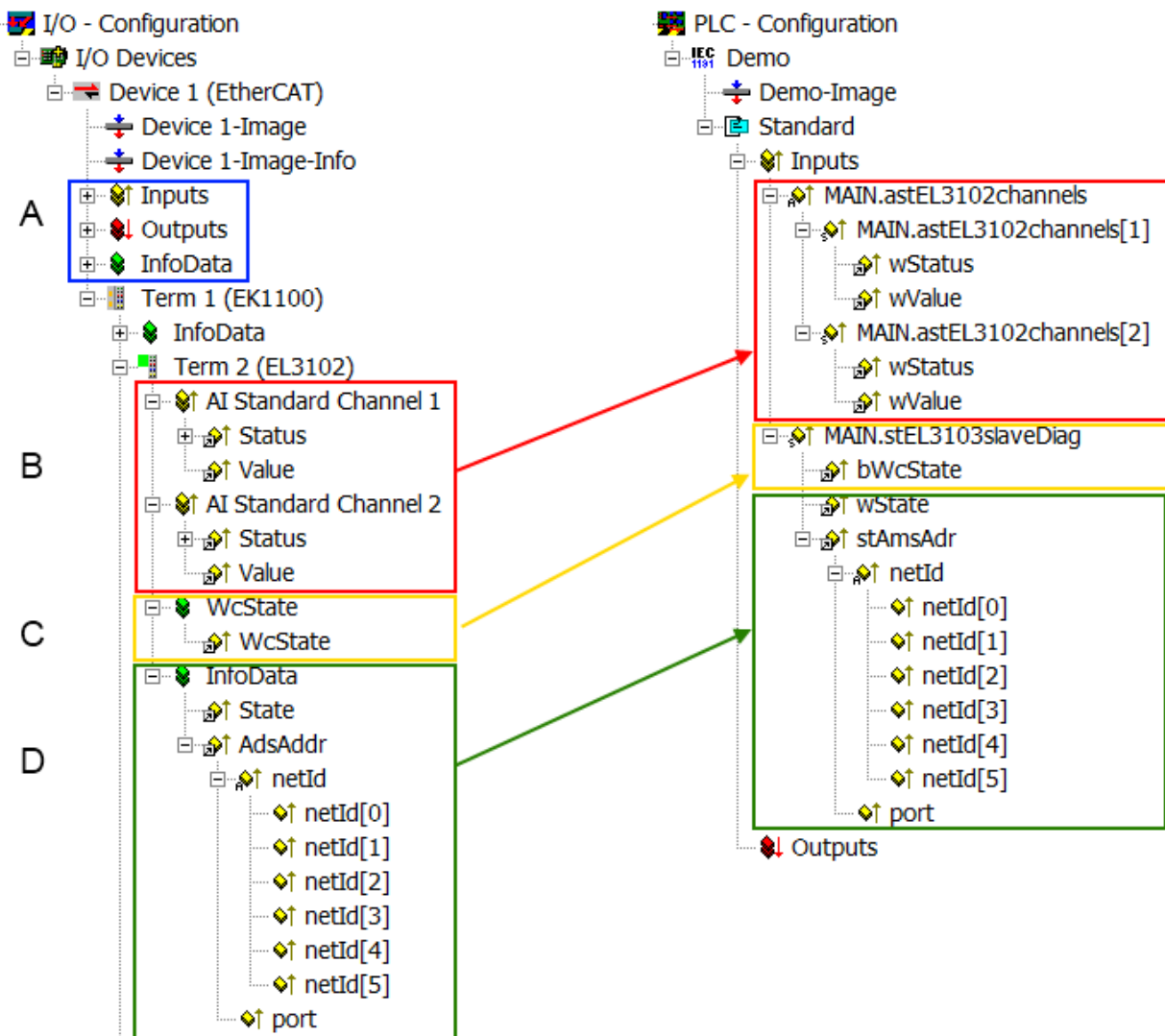

Fig. 140: Basic EtherCAT Slave Diagnosis in the PLC

The following aspects are covered here:

Code	Function	Implementation	Application/evaluation
A	The EtherCAT Master's diagnostic information updated acyclically (yellow) or provided acyclically (green).		At least the DevState is to be evaluated for the most recent cycle in the PLC. The EtherCAT Master's diagnostic information offers many more possibilities than are treated in the EtherCAT System Documentation. A few keywords: <ul style="list-style-type: none"> • CoE in the Master for communication with/through the Slaves • Functions from <i>TcEtherCAT.lib</i> • Perform an OnlineScan
B	In the example chosen (EL3102) the EL3102 comprises two analogue input channels that transmit a single function status for the most recent cycle.	Status <ul style="list-style-type: none"> • the bit significations may be found in the device documentation • other devices may supply more information, or none that is typical of a slave 	In order for the higher-level PLC task (or corresponding control applications) to be able to rely on correct data, the function status must be evaluated there. Such information is therefore provided with the process data for the most recent cycle.
C	For every EtherCAT Slave that has cyclic process data, the Master displays, using what is known as a WorkingCounter, whether the slave is participating successfully and without error in the cyclic exchange of process data. This important, elementary information is therefore provided for the most recent cycle in the System Manager <ol style="list-style-type: none"> 1. at the EtherCAT Slave, and, with identical contents 2. as a collective variable at the EtherCAT Master (see Point A) for linking.	WcState (Working Counter) 0: valid real-time communication in the last cycle 1: invalid real-time communication This may possibly have effects on the process data of other Slaves that are located in the same SyncUnit	In order for the higher-level PLC task (or corresponding control applications) to be able to rely on correct data, the communication status of the EtherCAT Slave must be evaluated there. Such information is therefore provided with the process data for the most recent cycle.
D	Diagnostic information of the EtherCAT Master which, while it is represented at the slave for linking, is actually determined by the Master for the Slave concerned and represented there. This information cannot be characterized as real-time, because it <ul style="list-style-type: none"> • is only rarely/never changed, except when the system starts up • is itself determined acyclically (e.g. EtherCAT Status) 	State current Status (INIT..OP) of the Slave. The Slave must be in OP (=8) when operating normally. <i>AdsAddr</i> The ADS address is useful for communicating from the PLC/task via ADS with the EtherCAT Slave, e.g. for reading/writing to the CoE. The AMS-NetID of a slave corresponds to the AMS-NetID of the EtherCAT Master; communication with the individual Slave is possible via the <i>port</i> (= EtherCAT address).	Information variables for the EtherCAT Master that are updated acyclically. This means that it is possible that in any particular cycle they do not represent the latest possible status. It is therefore possible to read such variables through ADS.

NOTE

Diagnostic information

It is strongly recommended that the diagnostic information made available is evaluated so that the application can react accordingly.

CoE Parameter Directory

The CoE parameter directory (CanOpen-over-EtherCAT) is used to manage the set values for the slave concerned. Changes may, in some circumstances, have to be made here when commissioning a relatively complex EtherCAT Slave. It can be accessed through the TwinCAT System Manager, see Fig. "EL3102, CoE directory".

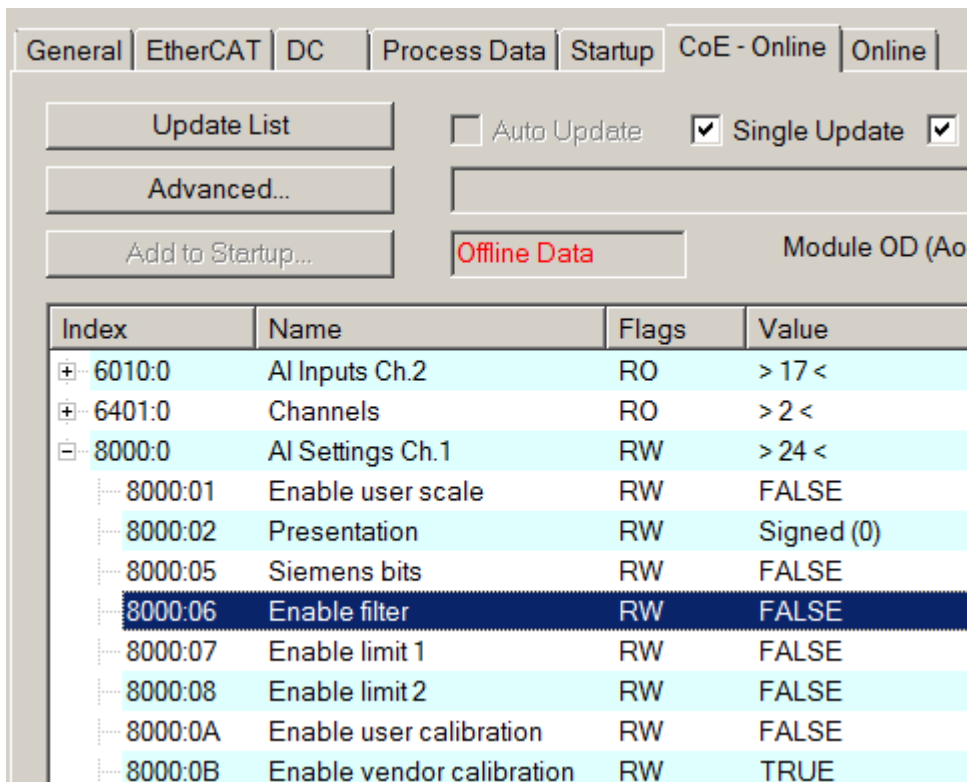

Fig. 141: EL3102, CoE directory

● EtherCAT System Documentation

i The comprehensive description in the [EtherCAT System Documentation](#) (EtherCAT Basics --> CoE Interface) must be observed!

A few brief extracts:

- Whether changes in the online directory are saved locally in the slave depends on the device. EL terminals (except the EL66xx) are able to save in this way.
- The user must manage the changes to the StartUp list.

Commissioning aid in the TwinCAT System Manager

Commissioning interfaces are being introduced as part of an ongoing process for EL/EP EtherCAT devices. These are available in TwinCAT System Managers from TwinCAT 2.11R2 and above. They are integrated into the System Manager through appropriately extended ESI configuration files.

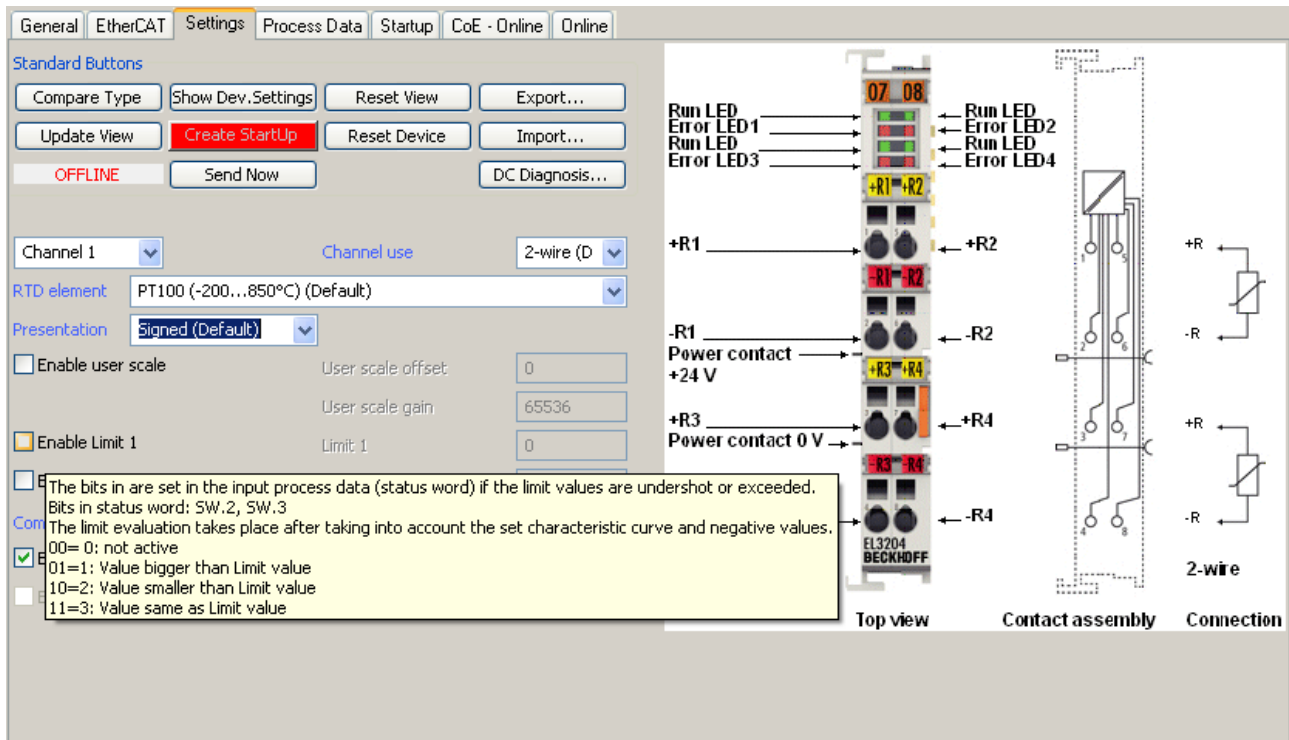

Fig. 142: Example of commissioning aid for a EL3204

This commissioning process simultaneously manages

- CoE Parameter Directory
- DC/FreeRun mode
- the available process data records (PDO)

Although the "Process Data", "DC", "Startup" and "CoE-Online" that used to be necessary for this are still displayed, it is recommended that, if the commissioning aid is used, the automatically generated settings are not changed by it.

The commissioning tool does not cover every possible application of an EL/EP device. If the available setting options are not adequate, the user can make the DC, PDO and CoE settings manually, as in the past.

EtherCAT State: automatic default behaviour of the TwinCAT System Manager and manual operation

After the operating power is switched on, an EtherCAT Slave must go through the following statuses

- INIT
- PREOP
- SAFEOP
- OP

to ensure sound operation. The EtherCAT Master directs these statuses in accordance with the initialization routines that are defined for commissioning the device by the ES/XML and user settings (Distributed Clocks (DC), PDO, CoE). See also the section on "Principles of [Communication, EtherCAT State Machine \[► 30\]](#)" in this connection. Depending how much configuration has to be done, and on the overall communication, booting can take up to a few seconds.

The EtherCAT Master itself must go through these routines when starting, until it has reached at least the OP target state.

The target state wanted by the user, and which is brought about automatically at start-up by TwinCAT, can be set in the System Manager. As soon as TwinCAT reaches the status RUN, the TwinCAT EtherCAT Master will approach the target states.

Standard setting

The advanced settings of the EtherCAT Master are set as standard:

- EtherCAT Master: OP
- Slaves: OP
This setting applies equally to all Slaves.

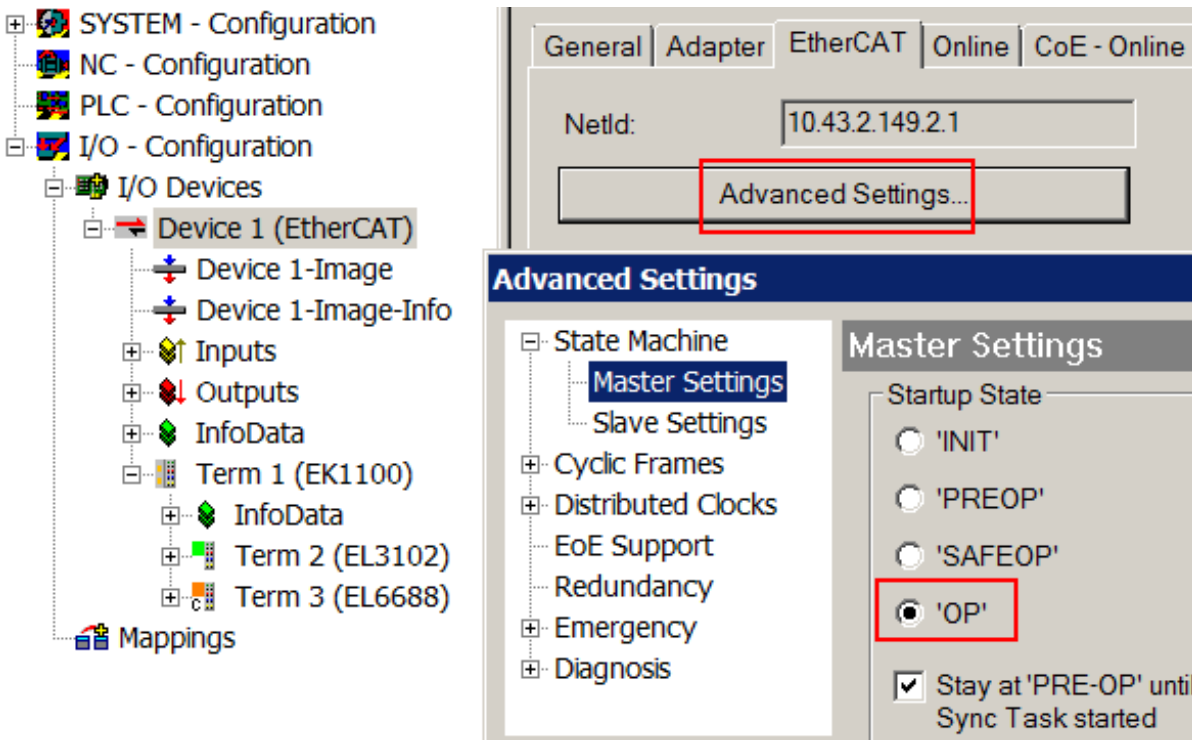

Fig. 143: Default behaviour of the System Manager

In addition, the target state of any particular Slave can be set in the "Advanced Settings" dialogue; the standard setting is again OP.

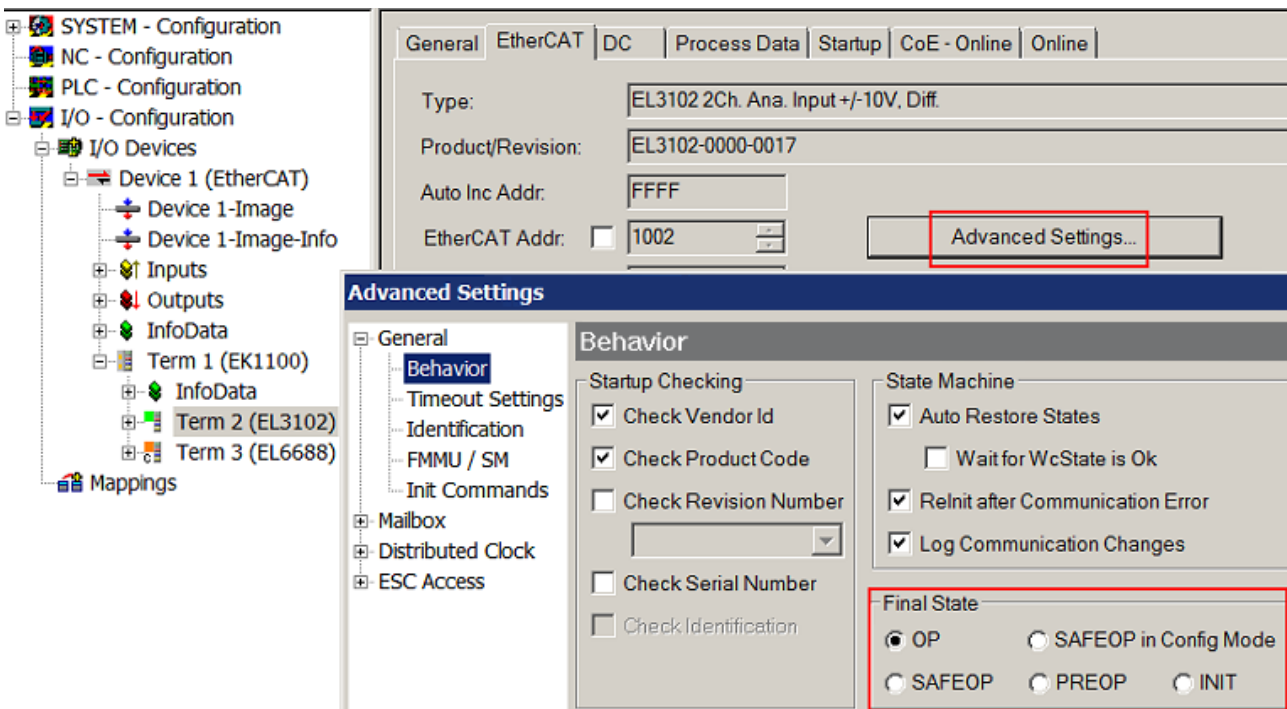

Fig. 144: Default target state in the Slave

Manual Control

There are particular reasons why it may be appropriate to control the states from the application/task/PLC. For instance:

- for diagnostic reasons
- to induce a controlled restart of axes
- because a change in the times involved in starting is desirable

In that case it is appropriate in the PLC application to use the PLC function blocks from the *TcEtherCAT.lib*, which is available as standard, and to work through the states in a controlled manner using, for instance, *FB_EcSetMasterState*.

It is then useful to put the settings in the EtherCAT Master to INIT for master and slave.

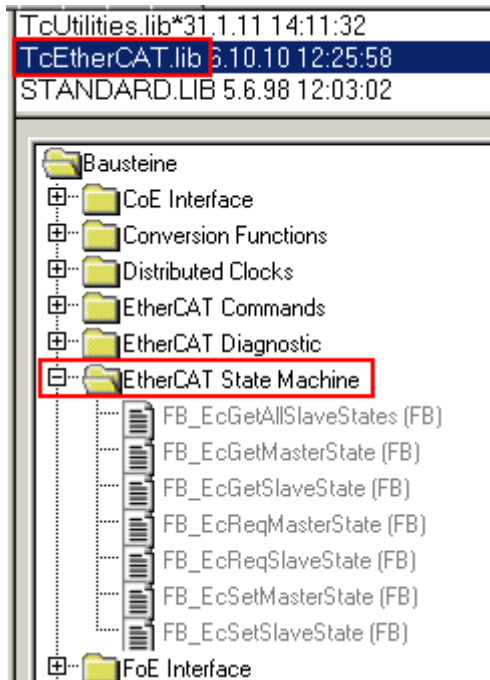

Fig. 145: PLC function blocks

Note regarding E-Bus current

EL/ES terminals are placed on the DIN rail at a coupler on the terminal strand. A Bus Coupler can supply the EL terminals added to it with the E-bus system voltage of 5 V; a coupler is thereby loadable up to 2 A as a rule. Information on how much current each EL terminal requires from the E-bus supply is available online and in the catalogue. If the added terminals require more current than the coupler can supply, then power feed terminals (e.g. EL9410) must be inserted at appropriate places in the terminal strand.

The pre-calculated theoretical maximum E-Bus current is displayed in the TwinCAT System Manager as a column value. A shortfall is marked by a negative total amount and an exclamation mark; a power feed terminal is to be placed before such a position.

General Adapter EtherCAT Online CoE - Online						
NetId:		10.43.2.149.2.1		Advanced Settings...		
Number	Box Name	Address	Type	In Size	Out S...	E-Bus (..
1	Term 1 (EK1100)	1001	EK1100			
2	Term 2 (EL3102)	1002	EL3102	8.0		1830
3	Term 4 (EL2004)	1003	EL2004		0.4	1730
4	Term 5 (EL2004)	1004	EL2004		0.4	1630
5	Term 6 (EL7031)	1005	EL7031	8.0	8.0	1510
6	Term 7 (EL2808)	1006	EL2808		1.0	1400
7	Term 8 (EL3602)	1007	EL3602	12.0		1210
8	Term 9 (EL3602)	1008	EL3602	12.0		1020
9	Term 10 (EL3602)	1009	EL3602	12.0		830
10	Term 11 (EL3602)	1010	EL3602	12.0		640
11	Term 12 (EL3602)	1011	EL3602	12.0		450
12	Term 13 (EL3602)	1012	EL3602	12.0		260
13	Term 14 (EL3602)	1013	EL3602	12.0		70
14	Term 3 (EL6688)	1014	EL6688	22.0		-240 !

Fig. 146: Illegally exceeding the E-Bus current

From TwinCAT 2.11 and above, a warning message "E-Bus Power of Terminal..." is output in the logger window when such a configuration is activated:

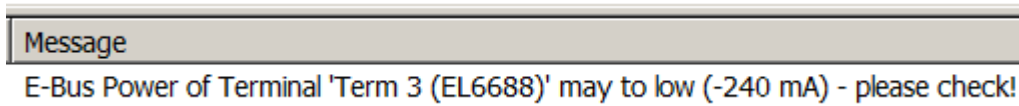

Fig. 147: Warning message for exceeding E-Bus current

NOTE

Caution! Malfunction possible!

The same ground potential must be used for the E-Bus supply of all EtherCAT terminals in a terminal block!

5.4 Process data

5.4.1 Sync Manager (SM)

The scope of the offered process data can be viewed on the “Process data” tab in the TwinCAT System Manager (see fig. *Process data tab SM2, EL34x3 + Process data tab SM3, EL34x3*).

The screenshot displays the 'Process Data' configuration window for a Sync Manager (SM). The window has several tabs: General, EtherCAT, Process Data (selected), Startup, CoE - Online, Diag History, and Online.

Sync Manager:

SM	Size	Type	Flags
0	128	MbxOut	
1	128	MbxIn	
2	5	Outputs	
3	68	Inputs	

PDO List:

Index	Size	Name	Flags	SM	SU
0x1A00	20.0	PM Inputs Channel 1	F	3	0
0x1A01	20.0	PM Inputs Channel 2	F	3	0
0x1A02	20.0	PM Inputs Channel 3	F	3	0
0x1A03	8.0	PM Auxiliary Inputs Auxiliary	F	3	0
0x1600	1.0	PM Outputs Channel 1	F	2	0
0x1601	1.0	PM Outputs Channel 2	F	2	0
0x1602	1.0	PM Outputs Channel 3	F	2	0
0x1603	2.0	PM Auxiliary Outputs Auxiliary	F	2	0

PDO Assignment (0x1C12):

- 0x1600
- 0x1601
- 0x1602
- 0x1603

PDO Content (0x1600):

Index	Size	Offs	Name	Type	Default (hex)
0x7000:01	1.0	0.0	Index	USINT	
		1.0			

Download:

- PDO Assignment
- PDO Configuration

Predefined PDO Assignment: 'Complete (Phase 1/2/3 + Auxiliary)'

Buttons: Load PDO info from device, Sync Unit Assignment...

Fig. 148: Process Data tab SM2, EL34x3

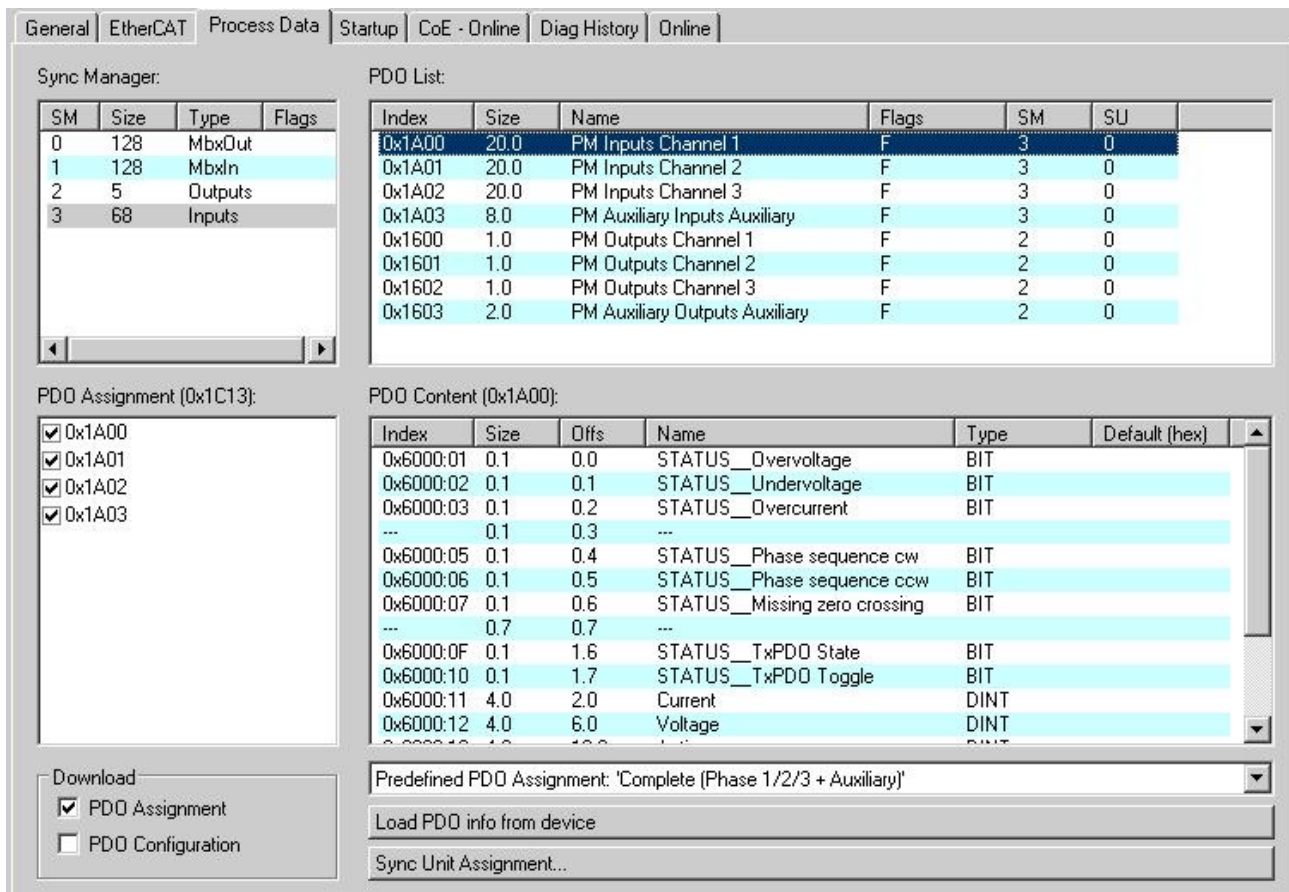

Fig. 149: Process Data tab SM3, EL34x3

PDO Assignment

SM2, PDO assignment 0x1C12				
Index	Index of excluded PDOs	Size (Byte. Bit)	Name	PDO content
0x1600 (default)	-	1.0	PM Outputs Channel 1	Index 0x7000:01 163 - Index
0x1601 (default)	-	1.0	PM Outputs Channel 2	Index 0x7010:01 163 - Index
0x1602 (default)	-	1.0	PM Outputs Channel 2	Index 0x7020:01 163 - Index
0x1603 (default)	-	2.0	PM Auxiliary Outputs Auxiliary	Index 0x7030:01 163 - Index Index 0x7030:02 163 - Channel

SM3, PDO Assignment 0x1C13				
Index	Index of excluded PDOs	Size (Byte. Bit)	Name	PDO content
0x1A00 (default)	-	20.0	PM Inputs Channel 1	Index 0x6000:01 158] - STATUS_Overtoltage Index 0x6000:02 158] - STATUS_Undervoltage Index 0x6000:03 158] - STATUS_Overcurrent Index 0x6000:05 159] - STATUS_Phase sequence cw Index 0x6000:06 158] - STATUS_Phase sequence ccw Index 0x6000:07 158] - STATUS_Missing zero crossing Index 0x6000:0F - STATUS_TxPDO State Index 0x6000:10 158] - STATUS_TxPDO Toggle Index 0x6000:11 158] - Current Index 0x6000:12 158] - Voltage Index 0x6000:13 158] - Active power Index 0x6000:14 158] - Index Index 0x6000:1D 158] - Variant value
0x1A01 (default)	-	20.0	PM Inputs Channel 2	Index 0x6010:01 159] - STATUS_Overtoltage Index 0x6010:02 159] - STATUS_Undervoltage Index 0x6010:03 159] - STATUS_Overcurrent Index 0x6010:05 159] - STATUS_Phase sequence cw Index 0x6010:06 159] - STATUS_Phase sequence ccw Index 0x6010:07 159] - STATUS_Missing zero crossing Index 0x6010:0F 159] - STATUS_TxPDO State Index 0x6010:10 159] - STATUS_TxPDO Toggle Index 0x6010:11 159] - Current Index 0x6010:12 159] - Voltage Index 0x6010:13 159] - Active power Index 0x6010:14 159] - Index Index 0x6010:1D 159] - Variant value
0x1A02 (default)	-	20.0	PM Inputs Channel 3	Index 0x6020:01 160] - STATUS_Overtoltage Index 0x6020:02 160] - STATUS_Undervoltage Index 0x6020:03 160] - STATUS_Overcurrent Index 0x6020:05 160] - STATUS_Phase sequence cw Index 0x6020:06 160] - STATUS_Phase sequence ccw Index 0x6020:07 160] - STATUS_Missing zero crossing Index 0x6020:0F 160] - STATUS_TxPDO State Index 0x6020:10 160] - STATUS_TxPDO Toggle Index 0x6020:11 160] - Current Index 0x6020:12 160] - Voltage Index 0x6020:13 160] - Active power Index 0x6020:14 160] - Index Index 0x6020:1D 160] - Variant value
0x1A03 (default)	-	8.0	PM Auxiliary Inputs Auxiliary	Index 0x6030:10 162] - STATUS_TxPDO Toggle Index 0x6030:11 162] - Index Index 0x6030:12 162] - Channel Index 0x6030:13 162] - Value

Table 1: PDO assignment of the SyncManager

5.4.2 Operating modes and settings

Confirmation of the variable output value, channel 1 - 3

(PDOs: PM inputs Channel 1 – 3, subindex “Index” [0x6000:14 ▶ 158], 0x6010:14 ▶ 159], 0x6020:14 ▶ 160])

The calculated values can be output on the PDOs: PM Inputs Channel 1 - 3, subindex “Variant value” [0x6000:1D ▶ 158], 0x6010:1D ▶ 159], 0x6020:1D ▶ 160]) (see [object description](#) ▶ 158]).

To this end, the corresponding values for the measured value to be output should be entered in the PDOs: PM Outputs Channel 1 - 3, subindex “Index” [0x7000:01 ▶ 163], 0x7010:01 ▶ 163], 0x7020:01 ▶ 163]).

Values (dec), Entry in index 0x7000:01 ▶ 163], 0x7010:01 ▶ 163], 0x7020:01 ▶ 163]	Name	Unit
0	Apparent power	0.01 VA
1	Reactive power	0.01 var
2	Energy	0.001 Wh
3	Power factor λ	0.001
4	Frequency	0.1 Hz
5	Energy (negative)	0.001 Wh
6	Angle λ between phase Lx and phase L1	0.01°
20	Active power fundamental	0.01 W
21	Apparent power fundamental	0.01 VA
22	Reactive power fundamental	0.01 var
30	Energy positive	0.001 Wh
31	Positive energy (automatically saved)	0.001 Wh
32	Energy (automatic saved)	0.001 Wh
35	Energy negative (automatically saved)	0.001 Wh
44	Frequency average resolution	0.01 Hz
45	Frequency high resolution	0.001 Hz
46	Held frequency	0.1 Hz
47	Held frequency average resolution	0.01 Hz
48	Held frequency high resolution	0.001 Hz
49-255	reserved	-

The standard output value is the apparent power.

Note firmware

i Index 20..22 and 44/45 from firmware 08 (EL3413-0000) or FW04 (EL3413-0120);
Index 30..32, 35, 46..48 from firmware 10 (further terminals)

Confirmation of the variable output value, auxiliary channel

(PDO: PM Inputs Auxiliary, subindex “Index” 0x6030:11 ▶ 162])

The calculated values can be output on the PDO: PM Inputs Auxiliary, subindex “Value” 0x6030:13 ▶ 162]) (see [object description](#) ▶ 162]).

To this end, the corresponding values for the measured value to be output should be entered in the PDO: PM Outputs Auxiliary, subindex “Index” 0x7030:01 ▶ 163]).

Values (dec), entry in index 0x7030:02	Values (dec), entry in index 0x7030:01	Name	Unit
0	0	Neutral conductor current	0.000001 A
0	2	Sum of the energy (channel 1-3)	0.001 Wh
0	4	Frequency	0.1 Hz
0	5	Sum of the energy (negative) (channel 1-3)	0.001 Wh
0	10	Sum of the active power (channel 1-3)	0.01 W
0	11	Sum of the apparent power (channel 1-3)	0.01 VA
0	12	Sum of the reactive power (channel 1-3)	0.01 var
0	15	Total current (added effective values!)	0.000001 A
0	20	Total active power fundamental	0.01 W
0	21	Total apparent power fundamental	0.01 VA
0	22	Total reactive power fundamental	0.01 var
0	30	Total energy positive	0.001 Wh
0	31	Total energy positive (automatically saved)	0.001 Wh
0	32	Total energy (automatically saved)	0.001 Wh
0	35	Total energy negative (automatically saved) (absolute value)	0.001 Wh
0	44	Frequency average resolution	0.01 Hz
0	45	Frequency high resolution	0.001 Hz
0	46	Held frequency	0.1 Hz
0	47	Held frequency average resolution	0.01 Hz
0	48	Held frequency high resolution	0.001 Hz
0	100	ADC temperature	0.1°C
1..3	0	Calculation ongoing	
1..3	1..21	RMS value of the xth harmonic (current)	0.000001 A
1..3	51..71	Ratio of the xth harmonic to the fundamental (current)	0.01%
1..3	100	Calculation ongoing	
1..3	101..121	RMS value of the xth harmonic (voltage)	0.0001 V
1..3	151..171	Ratio of the xth harmonic to the fundamental (voltage)	0.01%
11..13	0	Apparent power of phase x	0.01 VA
11..13	1	Reactive power of phase x	0.01 var
11..13	2	Energy of phase x	0.001 Wh
11..13	3	Power factor λ of phase x	0.001
11..13	4	Frequency of phase x	0.1 Hz
11..13	5	Energy (negative) of phase x	0.001 Wh
11..13	6	Angle α between phase x and phase 1	0.01°
11..13	10	Active power of phase x	0.01 W
11..13	11	Current of phase x	0.000001 A
11..13	12	Voltage of phase x	0.0001 V
11..13	20	Active power fundamental	0.01 W
11..13	21	Apparent power fundamental	0.01 VA
11..13	22	Reactive power fundamental	0.01 var
11..13	23	$\cos \varphi = P_{fund} / S_{fund}$ with sign from Q1	0.0001
11..13	24	$\cos \varphi = P_{fund} / S_{fund}$	0.0001
11..13	30	Energy positive	0.001 Wh
11..13	31	Positive energy (automatically saved)	0.001 Wh
11..13	32	Energy (automatic saved)	0.001 Wh
11..13	35	Energy negative (automatically saved) (absolute value)	0.001 Wh
11..13	44	Frequency average resolution	0.01 Hz
11..13	45	Frequency high resolution	0.001 Hz
11..13	46	Held frequency	0.1 Hz
11..13	47	Held frequency average resolution	0.01 Hz
11..13	48	Held frequency high resolution	0.001 Hz



Note firmware

Index 15, 20..22, 23 and 44/45 from firmware 08 (EL3413-0000) or firmware 04 (EL3413-0120), or FW10;
Index 24, 30..31, 35 and 46..48 from FW10

5.4.3 Predefined PDO Assignment

The "Predefined PDO Assignment" enables a simplified selection of the process data. The desired function is selected on the lower part of the "Process Data" tab. As a result, all necessary PDOs are automatically activated and the unnecessary PDOs are deactivated.

If channels are not to be used, it is recommended to deactivate the respective channels in order to avoid possible error messages from the terminal.

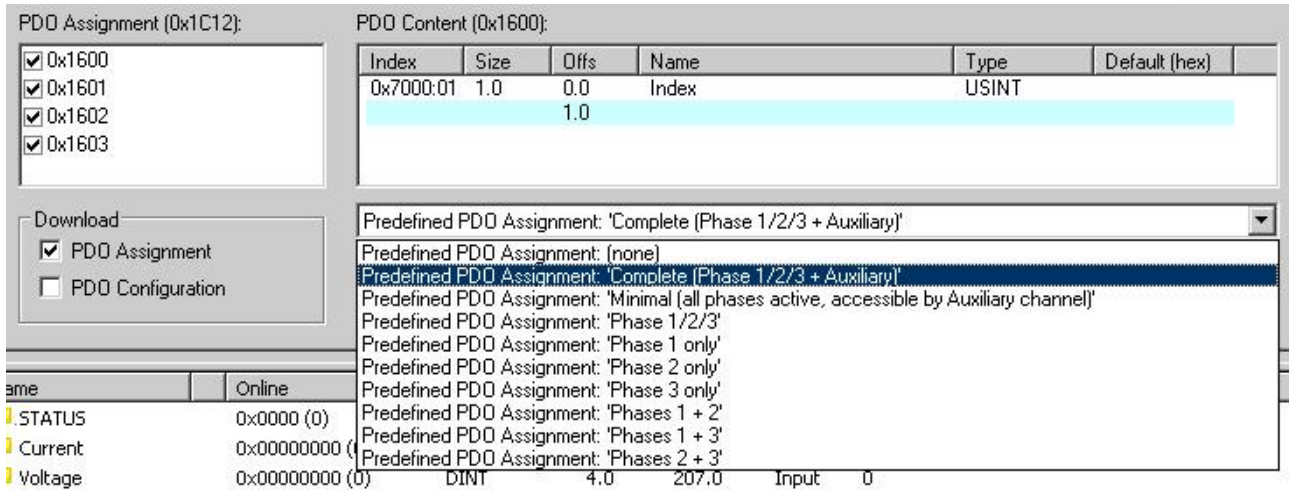

Fig. 150: Selection of predefined PDOs

There is a choice of nine PDO assignments:

Name	SM2, PDO assignment	SM3, PDO assignment
Complete (Phase 1/2/3 + Auxiliary)	0x1600 (PM Outputs Channel 1) 0x1601 (PM Outputs Channel 2) 0x1602 (PM Outputs Channel 3) 0x1603 (PM Outputs Auxiliary)	0x1A00 (PM Inputs Channel 1) 0x1A01 (PM Inputs Channel 2) 0x1A02 (PM Inputs Channel 3) 0x1A03 (PM Inputs Auxiliary)
Minimal (all phases active, accessible by Auxiliary channel)	0x1603 (PM Outputs Auxiliary)	0x1A03 (PM Inputs Auxiliary)
Phase 1/2/3	0x1600 (PM Outputs Channel 1) 0x1601 (PM Outputs Channel 2) 0x1602 (PM Outputs Channel 3)	0x1A00 (PM Inputs Channel 1) 0x1A01 (PM Inputs Channel 2) 0x1A02 (PM Inputs Channel 3)
Phase 1 only	0x1600 (PM Outputs Channel 1)	0x1A00 (PM Inputs Channel 1)
Phase 2 only	0x1601 (PM Outputs Channel 2)	0x1A01 (PM Inputs Channel 2)
Phase 3 only	0x1602 (PM Outputs Channel 3)	0x1A02 (PM Inputs Channel 3)
Phase 1+2	0x1600 (PM Outputs Channel 1) 0x1601 (PM Outputs Channel 2)	0x1A00 (PM Inputs Channel 1) 0x1A01 (PM Inputs Channel 2)
Phase 1+3	0x1600 (PM Outputs Channel 1) 0x1602 (PM Outputs Channel 3)	0x1A00 (PM Inputs Channel 1) 0x1A02 (PM Inputs Channel 3)
Phase 2+3	0x1601 (PM Outputs Channel 2) 0x1602 (PM Outputs Channel 3)	0x1A01 (PM Inputs Channel 2) 0x1A02 (PM Inputs Channel 3)

5.5 Start-up and parameter configuration

5.5.1 Settings

(Master TwinCAT 2.11 R3)

5.5.1.1 Reference channel for the frequency measurement and power/energy measurement

In the EL34x3 all 3 channels are always selected independently of one another as reference for the frequency measurement or power/energy measurement. In order to avoid an error message from the terminal, the channels that are not in use should be deactivated.

The correct channels can be selected with the help of the predefined PDOs. Beyond that individual phases can be switched on or off with the help of the Command Object (index [0xFB00:01](#) [[▶ 153](#)]).

5.5.1.2 Measuring cycle time

Number of periods taken as the basis for the calculation of the true RMS value. The higher this value the more uniform the output values. A minimum of 4 periods is necessary; however a minimum of 5 periods is recommended.

The default value of 10 periods has proven to be a good compromise between stability and speed.

The measuring cycle time can be changed with the help of the Command Object (index [0xFB00:01](#) [[▶ 153](#)]). The command is started by writing subindex 1 (request). Write access is disabled until the current command is completed.

0x0022	Measuring interval 4 periods
0x0122	Measuring interval 5 periods
0x0222	Measuring interval 10 periods (default)
0x0322	Measuring interval 16 periods
0x0422	Measuring interval 32 periods

Sample

In order to change the measuring interval to 16 periods, the value 0322_{hex} must be entered in Index [0xFB00:01](#) [[▶ 153](#)].

The adoption of the new measuring cycle time can take up to 10 seconds. The value is not stored in the EEPROM; following a voltage reset of the terminal a measuring cycle time of 10 periods is set again. In order to avoid this, the value can be set with the help of a startup parameter.

5.5.1.3 Current measuring range

The EL34x3 offer three current measuring ranges^{*)}. The full scale value of the current can set to 5 A, 1 A or 0.1 A for the EL3413-xxxx and to 10 A, 2 A or 0.2 A for the EL3433-xxxx. The correct setting of the full scale value is important in order to avoid unnecessary measurement inaccuracies. It is recommended to always measure in the upper third of the full scale value.

*) EL3413-0000: From HW10, FW07; 100 mA from KW35/2015;
 EL3413-0120: From HW10, FW04;
 EL3413-0001, EL3433 from release

Sample

In order to change the full scale value to 5 A on the EL3413-xxxx, the value 500_{dec} must be entered in index [0x802D:11](#) [[▶ 153](#)].

In the case of the EL3433-xxxx, the value 1000_{dec} must be entered in index [0x802D:11](#) [[▶ 153](#)] for 10 A.

NOTE

Risk of damage to the device!

Exceeding the full scale value can lead to incorrect measurement results and to damage to the terminal.

5.5.1.4 PM Command (Index 0xFB00)

The command object is used for triggering an action in the terminal. The command is started by writing subindex 1 (request). Write access is disabled until the current command is completed. When writing the subindex, note that you cannot write directly in the "Hex" field; the "Binary" field must be used for this. The input takes place in the reverse byte order, with space (see fig. *Writing the subindex 01, object FB00*).

Sample

To delete the energy values of all channels manually enter 0004_{hex} in index 0xFB00:01 [▶ 153].

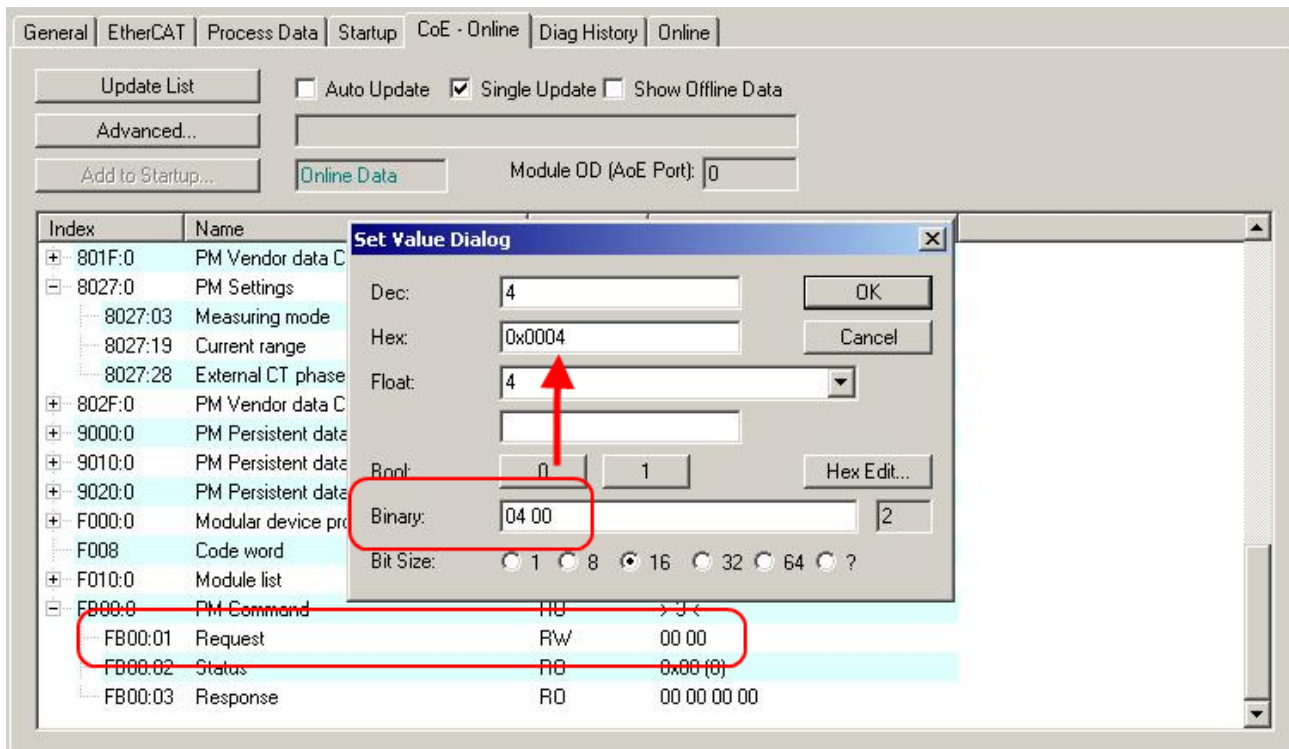

Fig. 151: Writing Subindex 01, Object FB00

5.5.2 Measurements

(Master TwinCAT 2.11 R3)

5.5.2.1 Energy

Name	Index	Variant Value	AUX channel		CoE	
			Sum (Ch 0)	Channel access (Ch 11/12/13)	0x90n0	0xF801 *)
Energy difference	2	E+ - E-	$\sum E+ - \sum E- $	E+ - E-	N/A	N/A
Energy negative	5	- E-	$\sum E- $	E-	E-	E-
Energy positive	30	E+	$\sum E+ $	E+	E+	E+
Energy difference (automatically saved)	32	E+ - E-	$\sum E+ - \sum E- $	E+ - E-	N/A	N/A
Energy negative (automatically saved)	35	- E-	$\sum E- $	E-	E-	E-
Positive energy (automatically saved)	31	E+	E+	E+	E+	E+

*) Access only possible from PLC

manually saved (Index [0x90x0:01](#) [[▶ 164](#)] and [0x90x0:02](#) [[▶ 164](#)])

The energy values of channels 1-3 can be saved in the Objects [0x90x0:01](#) [[▶ 164](#)] (e.g. before switching the system off in order to save the energy value as accurately as possible) or the energy values already saved can be deleted. This is initiated by the Command Object (Index [0xFB00:01](#) [[▶ 153](#)]). The negative energy value (generator mode) can be saved in the Objects [0x90x0:02](#) [[▶ 164](#)]. These values can only be saved or deleted manually.

This value is saved under Index 0xF801 in the case of the EL3403. For reasons of compatibility this index also exists in the EL34x3. If program modules are to access this index, these can continue to be used. However, it is recommended to use Index 0x90x0 in new applications.

Sample 1

If the energy value of channel 2 is to be saved manually enter 0214_{hex} in index [0xFB00:01](#) [[▶ 153](#)].

Sample 2

To delete the energy values of all channels manually enter 0004_{hex} in index [0xFB00:01](#) [[▶ 153](#)].

autosaved (Index [0x90x0:03](#) [[▶ 164](#)] and [0x90x0:04](#) [[▶ 164](#)])

The energy values of channels 1-3 are automatically saved in the Objects [0x90x0:03](#) [[▶ 164](#)] every 15 minutes. Beyond that the user has the possibility using the Command Object (Index [0xFB00:01](#) [[▶ 153](#)]) to also save the momentary energy value at a self-defined moment or to delete complete contents. The 15-minute timer starts again at zero at this moment.

Sample 1

If the energy value of all the channels is to be saved manually, enter 0034_{hex} in index [0xFB00:01](#) [[▶ 153](#)].

Sample 2

To delete the energy values of all channels manually enter 0024_{hex} in index 0xFB00:01 [▶ 153].

5.5.2.2 PM Inputs Channel 1/2/3

STATUS

The following useful status information for the respective channel can be read in with the "STATUS" structure.

- Overvoltage (voltage is greater than 415 V)
- Undervoltage (voltage is smaller than 5 V)
- Overcurrent (current is 1.1x greater than the full scale value)
- Phase sequence cw (clockwise-rotating field)
- Phase sequence ccw (counter-clockwise rotating field)
- Missing zero crossing
- TxPDO State
- TxPDO Toggle

Current

Cyclic measurement of the current of the respective phase.

Voltage

Cyclic measurement of the voltage of the respective phase.

Active power

Cyclic measurement of the active power of the respective phase.

Index

Indicates which parameter the "VariantValue" is currently measuring.

VariantValue

There are several parameters behind the VariantValue. It is possible to read in the following values for the respective channel.

- the apparent power
- the reactive power
- the energy
- the power factor λ
- the frequency
- the negative energy
- the angle α of the respective phase to phase L1

The individual parameters are switched over with the help of the respective cyclic output variable "Index".

● Interpretation of output values

i For time-averaged output values such as RMS values, a markedly longer change of the output value compared to the measuring cycle time can occur in the event of steep signal changes.

i Redundant checking of the mains frequency for system control is recommended.

The EL34x3 terminals are power measurement terminals. The mains frequency is measured and displayed, but it should not be used as the sole value to control systems. In particular, step changes in the mains frequency can influence the frequency measurement and produce implausible values.

Held frequency

Indices 46 to 48, "Held frequency", indicate the last frequency before an error occurs (Undervoltage, No zero crossing).

5.5.2.3 PM Inputs Channel Auxiliary

STATUS

The TxPDO Toggle of this channel can be read in here

Index

Indicates which parameter the "Value" is currently measuring.

Channel

Indicates the channel on which measurement is currently taking place.

Value

There are several parameters behind the Value. If the value 0 is entered in "Channel", the following values can be read in.

- Neutral conductor current
- Sum of the energy (phase 1-3)
- Frequency
- Sum of the negative energy (phase 1-3)
- Sum of the active power (phase 1-3)
- Sum of the reactive power (phase 1-3)
- Sum of the apparent power (phase 1-3)
- Temperature at the ADC

If the value 1, 2 or 3 is entered in the channel, the following values of the respective phase 1, 2 or 3 can be read in.

- RMS value of the harmonic of the current
- Ratio of the harmonic to the fundamental of the current
- RMS value of the harmonic of the voltage
- Ratio of the harmonic to the fundamental of the voltage

If the value 11, 12 or 13 is entered in the channel, the following values of the respective phase 1, 2 or 3 can be read in.

- the apparent power
- the reactive power
- the energy
- the power factor λ
- the frequency
- the negative energy
- the angle α of the respective phase to phase L1

- the current
- the voltage
- the active power
- the power factor $\cos \varphi$

Switching of the individual parameters takes place using the cyclic "Index" output variables (see also tables in chapter "[Operating modes and settings](#)" [[▶ 131](#)]).

5.5.2.4 PM Outputs Channel 1/2/3

Index

The value of the parameter that is to be measured and read in in the corresponding "Variant value" is to be entered here.

5.5.2.5 PM Outputs Channel Auxiliary

Index

The value of the parameter that is to be measured and read in in the "Value" is to be entered here.

Channel

The phase that is to be measured can be selected here.

5.5.3 Scaling factors

The following overview indicates the scaling factors that are required for the calculation of the actual values from the raw process data values.

Scaling factors EL34x3

Values EL3413-xxxx	Values EL3433-xxxx	Calculation
Current (5 A)	Current (10 A)	Raw values x 0.000001 A x current transformer ratio
Current (1 A)	Current (2 A)	Raw values x 0.000001 A x current transformer ratio
Current (0.1 A) [currently inactive on the EL3413-0001]	Current (0.2 A)	Raw values x 0.000001 A x current transformer ratio
Neutral conductor current (5 A)	Neutral conductor current (10 A)	Raw values x 0.000001 A x current transformer ratio
Voltage	Voltage	Raw values x 0.0001 V x voltage transformer ratio
Active power	Active power	Raw values x 0.01 W x current transformer ratio x voltage transformer ratio
Apparent power	Apparent power	Raw values x 0.01 VA x current transformer ratio x voltage transformer ratio
Reactive power	Reactive power	Raw values x 0.01 VA x current transformer ratio x voltage transformer ratio
Energy	Energy	Raw values x 0.001 Wh x current transformer ratio
Power factor λ	Power factor λ	Raw values x 0.001
Frequency	Frequency	Raw values x 0.1 Hz; 0.01 Hz; 0.001 Hz
Angle α	Angle α	Raw values x 0.01°
Power factor $\cos \varphi$	Power factor $\cos \varphi$	Raw values x 0.001
RMS value of harmonic (Current 1 A)	RMS value of harmonic (Current 2 A)	Raw values x 0.000001 A x current transformer ratio
RMS value of harmonic (Current 5 A)	RMS value of harmonic (Current 10 A)	Raw values x 0.000001 A x current transformer ratio
Ratio of harmonic to fundamental	Ratio of harmonic to fundamental	Raw values x 0.01 %
RMS value of harmonic Voltage	RMS value of harmonic Voltage	Raw values x 0.0001 V x voltage transformer ratio

Table 1: Scaling factors for the calculation of the actual values from raw process data values

● Technical data



All technical specifications apply to "3-phase 4-wire system with earthed neutral conductor", unless explicitly stated otherwise.

● Full scale value of the measuring range of the neutral conductor current



The full scale value of the measuring range of the neutral conductor current always corresponds to the maximum current of the terminal (EL3413 = 5 A and EL3433 = 10 A) and cannot be switched.

5.6 Notices on analog specifications

Beckhoff I/O devices (terminals, boxes, modules) with analog inputs are characterized by a number of technical characteristic data; refer to the technical data in the respective documents.

Some explanations are given below for the correct interpretation of these characteristic data.

5.6.1 Full scale value (FSV)

An I/O device with an analog input measures over a nominal measuring range that is limited by an upper and a lower limit (initial value and end value); these can usually be taken from the device designation. The range between the two limits is called the measuring span and corresponds to the equation (end value - initial value). Analogous to pointing devices this is the measuring scale (see IEC 61131) or also the dynamic range.

For analog I/O devices from Beckhoff the rule is that the limit with the largest value is chosen as the full scale value of the respective product (also called the reference value) and is given a positive sign. This applies to both symmetrical and asymmetrical measuring spans.

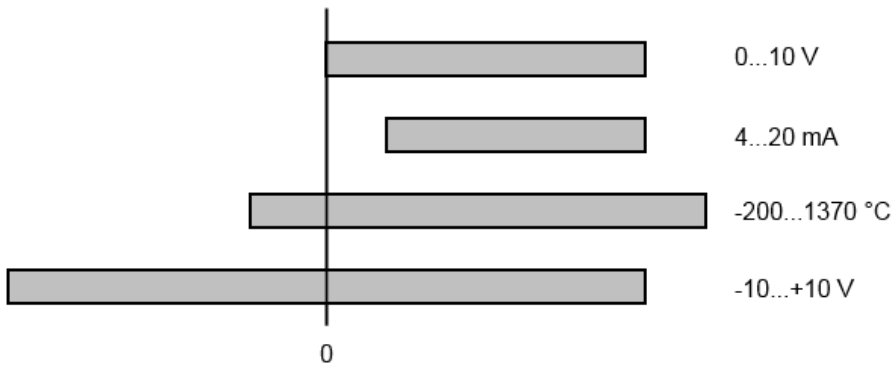

Fig. 152: Full scale value, measuring span

For the above **examples** this means:

- Measuring range 0...10 V: asymmetric unipolar, full scale value = 10 V, measuring span = 10 V
- Measuring range 4...20 mA: asymmetric unipolar, full scale value = 20 mA, measuring span = 16 mA
- Measuring range -200...1370°C: asymmetric bipolar, full scale value = 1370°C, measuring span = 1570°C
- Measuring range -10...+10 V: symmetric bipolar, full scale value = 10 V, measuring span = 20 V

This applies to analog output terminals/ boxes (and related Beckhoff product groups).

5.6.2 Measuring error/ measurement deviation

The relative measuring error (% of the full scale value) is referenced to the full scale value and is calculated as the quotient of the largest numerical deviation from the true value ('measuring error') referenced to the full scale value.

$$\text{Measuring error} = \frac{|\text{max. deviation}|}{\text{full scale value}}$$

The measuring error is generally valid for the entire permitted operating temperature range, also called the 'usage error limit' and contains random and systematic portions of the referred device (i.e. 'all' influences such as temperature, inherent noise, aging, etc.).

It is always to be regarded as a positive/negative span with ±, even if it is specified without ± in some cases.

The maximum deviation can also be specified directly.

Example: Measuring range 0...10 V and measuring error < ± 0.3 % full scale value → maximum deviation ± 30 mV in the permissible operating temperature range.

● Lower measuring error

i Since this specification also includes the temperature drift, a significantly lower measuring error can usually be assumed in case of a constant ambient temperature of the device and thermal stabilization after a user calibration.

This applies to analog output devices.

5.6.3 Temperature coefficient tK [ppm/K]

An electronic circuit is usually temperature dependent to a greater or lesser degree. In analog measurement technology this means that when a measured value is determined by means of an electronic circuit, its deviation from the "true" value is reproducibly dependent on the ambient/operating temperature.

A manufacturer can alleviate this by using components of a higher quality or by software means.

The temperature coefficient, when indicated, specified by Beckhoff allows the user to calculate the expected measuring error outside the basic accuracy at 23 °C.

Due to the extensive uncertainty considerations that are incorporated in the determination of the basic accuracy (at 23 °C), Beckhoff recommends a quadratic summation.

Example: Let the basic accuracy at 23 °C be $\pm 0.01\%$ typ. (full scale value), $tK = 20$ ppm/K typ.; the accuracy A35 at 35 °C is wanted, hence $\Delta T = 12$ K

$$G_{35} = \sqrt{(0.01\%)^2 + (12K \cdot 20 \frac{\text{ppm}}{K})^2} = 0.026\% \text{ full scale value, typ}$$

Remarks: ppm $\triangleq 10^{-6}$ % $\triangleq 10^{-2}$

5.6.4 Single-ended/differential typification

For analog inputs Beckhoff makes a basic distinction between two types: *single-ended* (SE) and *differential* (DIFF), referring to the difference in electrical connection with regard to the potential difference.

The diagram shows two-channel versions of an SE module and a DIFF module as examples for all multi-channel versions.

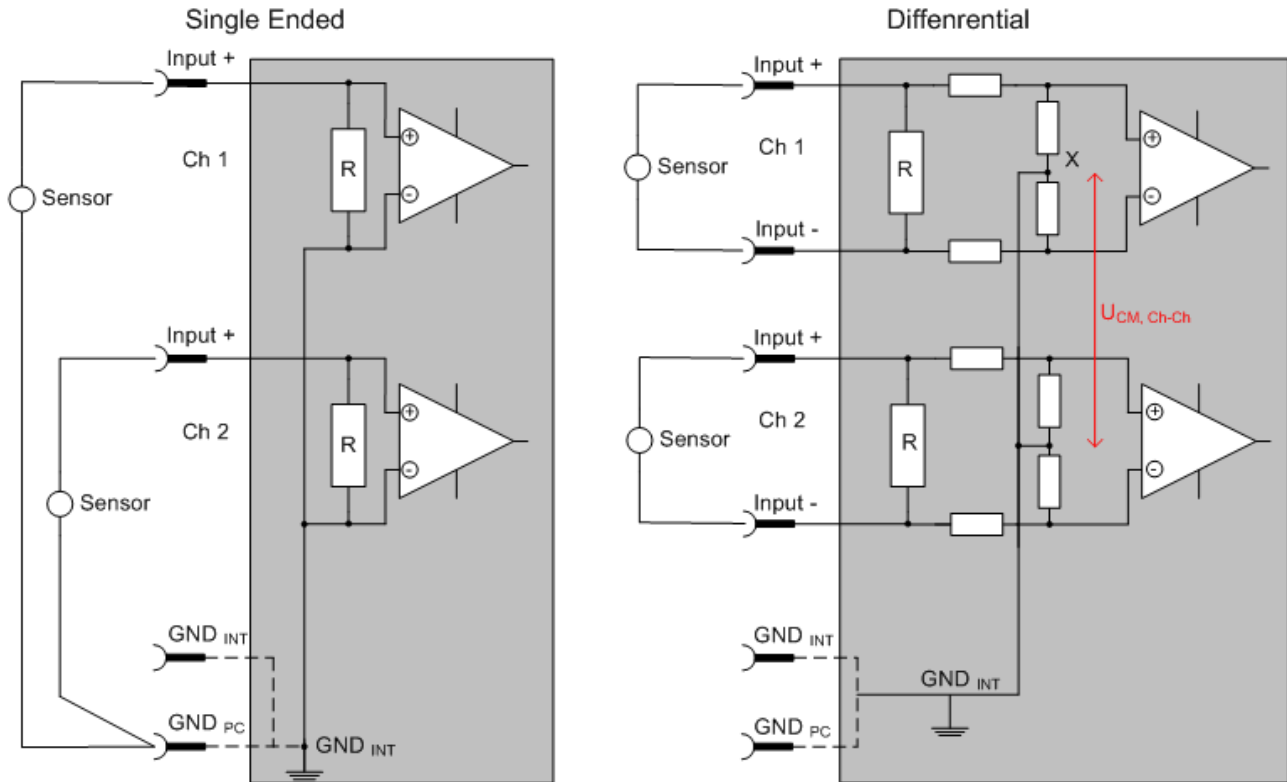

Fig. 153: SE and DIFF module as 2-channel version

Note: Dashed lines indicate that the respective connection may not necessarily be present in each SE or DIFF module. Electrical isolated channels are operating as differential type in general, hence there is no direct relation (voltaic) to ground within the module established at all. Indeed, specified information to recommended and maximum voltage levels have to be taken into account.

The basic rule:

- Analog measurements always take the form of voltage measurements between two potential points. For voltage measurements a large R is used, in order to ensure a high impedance. For current measurements a small R is used as shunt. If the purpose is resistance measurement, corresponding considerations are applied.
 - Beckhoff generally refers to these two points as input+/signal potential and input-/reference potential.
 - For measurements between two potential points two potentials have to be supplied.
 - Regarding the terms "single-wire connection" or "three-wire connection", please note the following for pure analog measurements: three- or four-wire connections can be used for sensor supply, but are not involved in the actual analog measurement, which always takes place between two potentials/wires. In particular this also applies to SE, even though the term suggest that only one wire is required.
- The term "electrical isolation" should be clarified in advance. Beckhoff IO modules feature 1..8 or more analog channels; with regard to the channel connection a distinction is made in terms of:
 - how the channels WITHIN a module relate to each other, or
 - how the channels of SEVERAL modules relate to each other.

The property of electrical isolation indicates whether the channels are directly connected to each other.

- Beckhoff terminals/ boxes (and related product groups) always feature electrical isolation between the field/analog side and the bus/EtherCAT side. In other words, if two analog terminals/ boxes are not connected via the power contacts (cable), the modules are effectively electrically isolated.
- If channels within a module are electrically isolated, or if a single-channel module has no power contacts, the channels are effectively always differential. See also explanatory notes below. Differential channels are not necessarily electrically isolated.
- Analog measuring channels are subject to technical limits, both in terms of the recommended operating range (continuous operation) and the destruction limit. Please refer to the respective terminal/ box documentation for further details.

Explanation

• differential (DIFF)

- Differential measurement is the most flexible concept. The user can freely choose both connection points, input+/signal potential and input-/reference potential, within the framework of the technical specification.
- A differential channel can also be operated as SE, if the reference potential of several sensors is linked. This interconnection may take place via the system GND.
- Since a differential channel is configured symmetrically internally (cf. Fig. SE and DIFF module as 2-channel variant), there will be a mid-potential (X) between the two supplied potentials that is the same as the internal ground/reference ground for this channel. If several DIFF channels are used in a module without electrical isolation, the technical property V_{CM} (common-mode voltage) indicates the degree to which the mean voltage of the channels may differ.
- The internal reference ground may be accessible as connection point at the terminal/ box, in order to stabilize a defined GND potential in the terminal/ box. In this case it is particularly important to pay attention to the quality of this potential (noiselessness, voltage stability). At this GND point a wire may be connected to make sure that $V_{CM,max}$ is not exceeded in the differential sensor cable. If differential channels are not electrically isolated, usually only one $V_{CM,max}$ is permitted. If the channels are electrically isolated this limit should not apply, and the channels voltages may differ up to the specified separation limit.
- Differential measurement in combination with correct sensor wiring has the special advantage that any interference affecting the sensor cable (ideally the feed and return line are arranged side by side, so that interference signals have the same effect on both wires) has very little effect on the measurement, since the potential of both lines varies jointly (hence the term common mode). In simple terms: Common-mode interference has the same effect on both wires in terms of amplitude and phasing.
- Nevertheless, the suppression of common-mode interference within a channel or between channels is subject to technical limits, which are specified in the technical data.
- Further helpfully information on this topic can be found on the documentation page *Configuration of 0/4..20 mA differential inputs* (see documentation for the EL30xx terminals, for example).

• Single Ended (SE)

- If the analog circuit is designed as SE, the input/reference wire is internally fixed to a certain potential that cannot be changed. This potential must be accessible from outside on at least one point for connecting the reference potential, e.g. via the power contacts (cable).
- In other words, in situations with several channels SE offers users the option to avoid returning at least one of the two sensor cables to the terminal/ box (in contrast to DIFF). Instead, the reference wire can be consolidated at the sensors, e.g. in the system GND.
- A disadvantage of this approach is that the separate feed and return line can result in voltage/ current variations, which a SE channel may no longer be able to handle. See common-mode interference. A V_{CM} effect cannot occur, since the module channels are internally always 'hard-wired' through the input/reference potential.

Typification of the 2/3/4-wire connection of current sensors

Current transducers/sensors/field devices (referred to in the following simply as 'sensor') with the industrial 0/4-20 mA interface typically have internal transformation electronics for the physical measured variable (temperature, current, etc.) at the current control output. These internal electronics must be supplied with energy (voltage, current). The type of cable for this supply thus separates the sensors into *self-supplied* or *externally supplied* sensors:

Self-supplied sensors

- The sensor draws the energy for its own operation via the sensor/signal cable + and -. So that enough energy is always available for the sensor's own operation and open-circuit detection is possible, a lower limit of 4 mA has been specified for the 4-20 mA interface; i.e. the sensor allows a minimum current of 4 mA and a maximum current of 20 mA to pass.
- 2-wire connection see Fig. *2-wire connection*, cf. IEC60381-1
- Such current transducers generally represent a current sink and thus like to sit between + and – as a 'variable load'. Refer also to the sensor manufacturer's information.

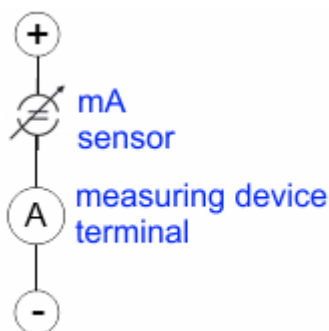

Fig. 154: 2-wire connection

Therefore, they are to be connected according to the Beckhoff terminology as follows:

preferably to **'single-ended' inputs** if the +Supply connections of the terminal/ box are also to be used - connect to +Supply and Signal

they can, however, also be connected to **'differential' inputs**, if the termination to GND is then manufactured on the application side – to be connected with the right polarity to +Signal and –Signal. It is important to refer to the information page *Configuration of 0/4..20 mA differential inputs* (see documentation for the EL30xx terminals, for example)!

Externally supplied sensors

- 3- and 4-wire connection see Fig. *Connection of externally supplied sensors*, cf. IEC60381-1
- the sensor draws the energy/operating voltage for its own operation from 2 supply cables of its own. One or two further sensor cables are used for the signal transmission of the current loop:
 - 1 sensor cable: according to the Beckhoff terminology such sensors are to be connected to **'single-ended' inputs** in 3 cables with +/-Signal lines and if necessary FE/shield
 - 2 sensor cables: for sensors with 4-wire connection based on +supply/-supply/+signal/-signal, check whether +signal can be connected to +supply or –signal to –supply.
 - Yes: then you can connect accordingly to a Beckhoff **'single-ended' input**.
 - No: the Beckhoff **'differential' input** for +Signal and –Signal is to be selected; +Supply and –Supply are to be connected via additional cables.
 It is important to refer to the information page *Configuration of 0/4..20 mA differential inputs* (see documentation for the EL30xx terminals, for example)!

Note: expert organizations such as NAMUR demand a usable measuring range <4 mA/>20 mA for error detection and adjustment, see also NAMUR NE043.

The Beckhoff device documentation must be consulted in order to see whether the respective device supports such an extended signal range.

Usually there is an internal diode existing within unipolar terminals/ boxes (and related product groups), in this case the polarity/direction of current have to be observed.

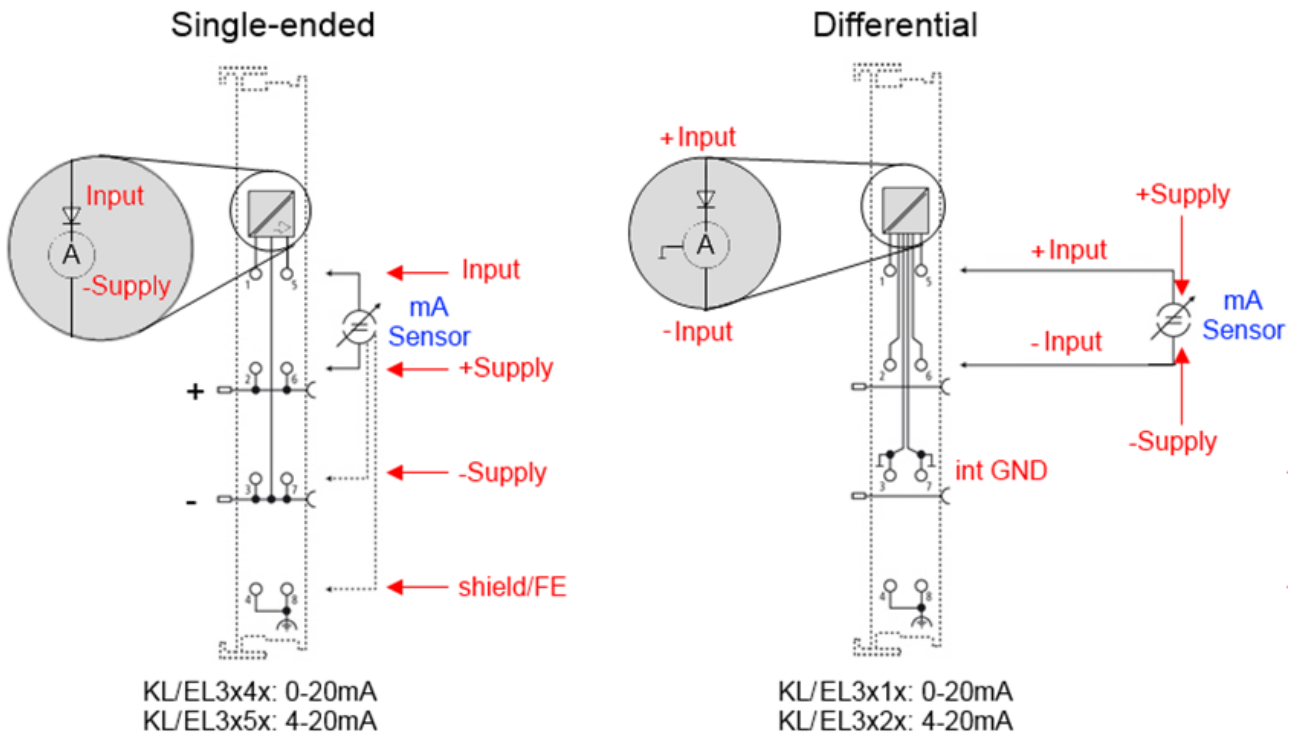

Fig. 155: Connection of externally supplied sensors

Classification of the Beckhoff terminals/ boxes - Beckhoff 0/4-20 mA terminals/ boxes (and related product groups) are available as **differential** and **single-ended** terminals/ boxes (and related product groups):

Single-ended

EL3x4x: 0-20 mA, EL3x5x: 4-20 mA; KL and related product groups exactly the same
Preferred current direction because of internal diode
Designed for the connection of externally-supplied sensors with a 3/4-wire connection
Designed for the connection of self-supplied sensors with a 2-wire connection

Differential

EL3x1x: 0-20 mA, EL3x2x: 4-20 mA; KL and related product groups exactly the same
Preferred current direction because of internal diode
The terminal/ box is a passive differential current measuring device; passive means that the sensor is not supplied with power.

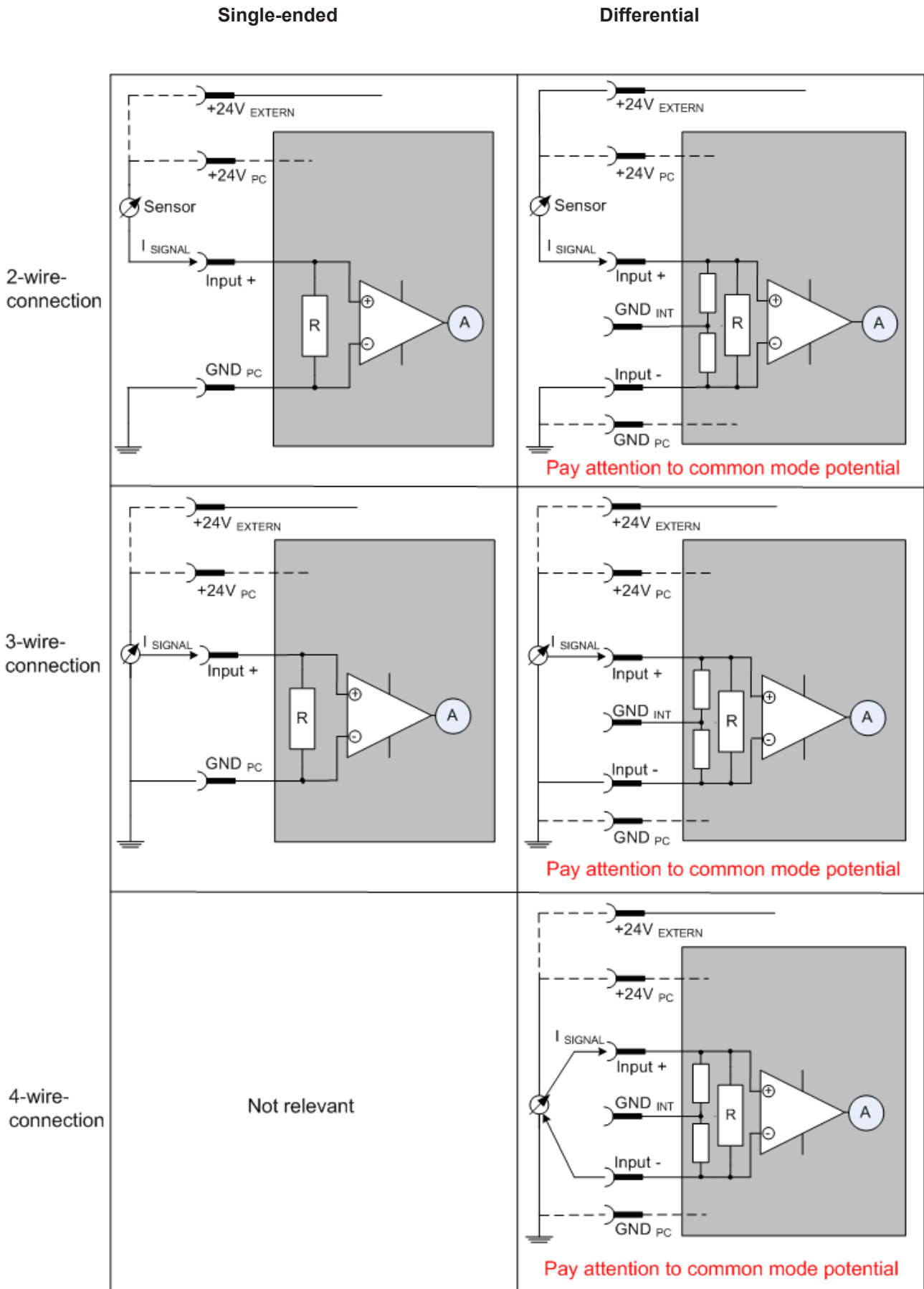

Fig. 156: 2-, 3- and 4-wire connection at single-ended and differential inputs

5.6.5 Common-mode voltage and reference ground (based on differential inputs)

Common-mode voltage (V_{cm}) is defined as the average value of the voltages of the individual connections/ inputs and is measured/specified against reference ground.

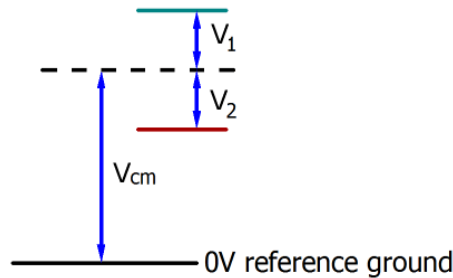

Fig. 157: Common-mode voltage (V_{cm})

The definition of the reference ground is important for the definition of the permitted common-mode voltage range and for measurement of the common-mode rejection ratio (CMRR) for differential inputs.

The reference ground is also the potential against which the input resistance and the input impedance for single-ended inputs or the common-mode resistance and the common-mode impedance for differential inputs is measured.

The reference ground is usually accessible at or near the terminal/ box, e.g. at the terminal contacts, power contacts (cable) or a mounting rail. Please refer to the documentation regarding positioning. The reference ground should be specified for the device under consideration.

For multi-channel terminals/ boxes with resistive (=direct, ohmic, galvanic) or capacitive connection between the channels, the reference ground should preferably be the symmetry point of all channels, taking into account the connection resistances.

Reference ground samples for Beckhoff IO devices:

1. Internal AGND fed out: EL3102/EL3112, resistive connection between the channels
2. 0V power contact: EL3104/EL3114, resistive connection between the channels and AGND; AGND connected to 0V power contact with low-resistance
3. Earth or SGND (shield GND):
 - EL3174-0002: Channels have no resistive connection between each other, although they are capacitively coupled to SGND via leakage capacitors
 - EL3314: No internal ground fed out to the terminal points, although capacitive coupling to SGND

5.6.6 Dielectric strength

A distinction should be made between:

- Dielectric strength (destruction limit): Exceedance can result in irreversible changes to the electronics
 - Against a specified reference ground
 - Differential
- Recommended operating voltage range: If the range is exceeded, it can no longer be assumed that the system operates as specified
 - Against a specified reference ground
 - Differential

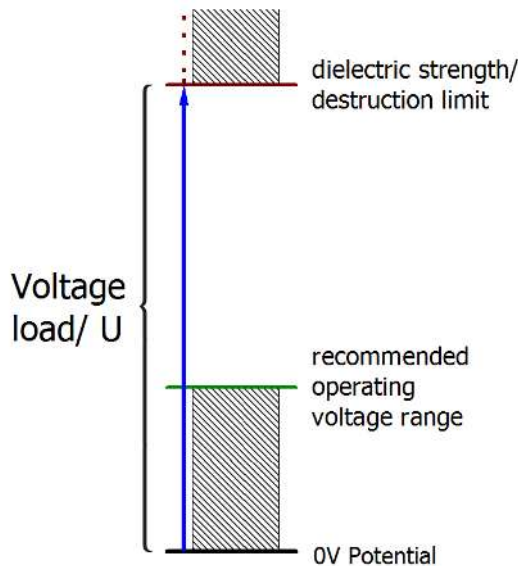

Fig. 158: Recommended operating voltage range

The device documentation may contain particular specifications and timings, taking into account:

- Self-heating
- Rated voltage
- Insulating strength
- Edge steepness of the applied voltage or holding periods
- Normative environment (e.g. PELV)

5.6.7 Temporal aspects of analog/digital conversion

The conversion of the constant electrical input signal to a value-discrete digital and machine-readable form takes place in the analog Beckhoff EL/KL/EP input modules with ADC (analog digital converter). Although different ADC technologies are in use, from a user perspective they all have a common characteristic: after the conversion a certain digital value is available in the controller for further processing. This digital value, the so-called analog process data, has a fixed temporal relationship with the “original parameter”, i.e. the electrical input value. Therefore, corresponding temporal characteristic data can be determined and specified for Beckhoff analogue input devices.

This process involves several functional components, which act more or less strongly in every AI (analog input) module:

- the electrical input circuit
- the analog/digital conversion
- the digital further processing
- the final provision of the process and diagnostic data for collection at the fieldbus (EtherCAT, K-bus, etc.)

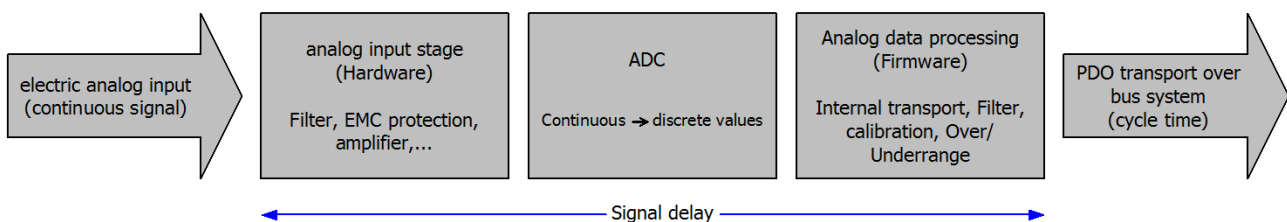

Fig. 159: Signal processing analog input

Two aspects are crucial from a user perspective:

- “How often do I receive new values?”, i.e. a sampling rate in terms of speed with regard to the device/channel
- What delay does the (whole) AD conversion of the device/channel cause?
I.e. the hardware and firmware components in its entirety. For technological reasons, the signal characteristics must be taken into account when determining this information: the run times through the system differ, depending on the signal frequency.

This is the “external” view of the “Beckhoff AI channel” system – internally the signal delay in particular is composed of different components: hardware, amplifier, conversion itself, data transport and processing. Internally a higher sampling rate may be used (e.g. in the deltaSigma converters) than is offered “externally” from the user perspective. From a user perspective of the “Beckhoff AI channel” component this is usually irrelevant or is specified accordingly, if it is relevant for the function.

For Beckhoff AI devices the following specification parameters for the AI channel are available for the user from a temporal perspective:

1. Minimum conversion time [ms, µs]

This is the reciprocal value of the maximum **sampling rate** [sps, samples per second]:

Indicates how often the analog channel makes a newly detected process data value available for collection by the fieldbus. Whether the fieldbus (EtherCAT, K-bus) fetches the value with the same speed (i.e. synchronous), or more quickly (if the AI channel operates in slow FreeRun mode) or more slowly (e.g. with oversampling), is then a question of the fieldbus setting and which modes the AI device supports.

For EtherCAT devices the so-called toggle bit indicates (by toggling) for the diagnostic PDOs when a newly determined analog value is available.

Accordingly, a maximum conversion time, i.e. a smallest sampling rate supported by the AI device, can be specified.

Corresponds to IEC 61131-2, section 7.10.2 2, “Sampling repeat time”

2. Typical signal delay

Corresponds to IEC 61131-2, section 7.10.2 1, “Sampling duration”. From this perspective it includes all internal hardware and firmware components, but not “external” delay components from the fieldbus or the controller (TwinCAT).

This delay is particularly relevant for absolute time considerations, if AI channels also provide a time stamp that corresponds to the amplitude value – which can be assumed to match the physically prevailing amplitude value at the time.

Due to the frequency-dependent signal delay time, a dedicated value can only be specified for a given signal. The value also depends on potentially variable filter settings of the channel.

A typical characterization in the device documentation may be:

2.1 Signal delay (step response)

Keywords: Settling time

The square wave signal can be generated externally with a frequency generator (note impedance!)

The 90 % limit is used as detection threshold.

The signal delay [ms, µs] is then the time interval between the (ideal) electrical square wave signal and the time at which the analog process value has reached the 90 % amplitude.

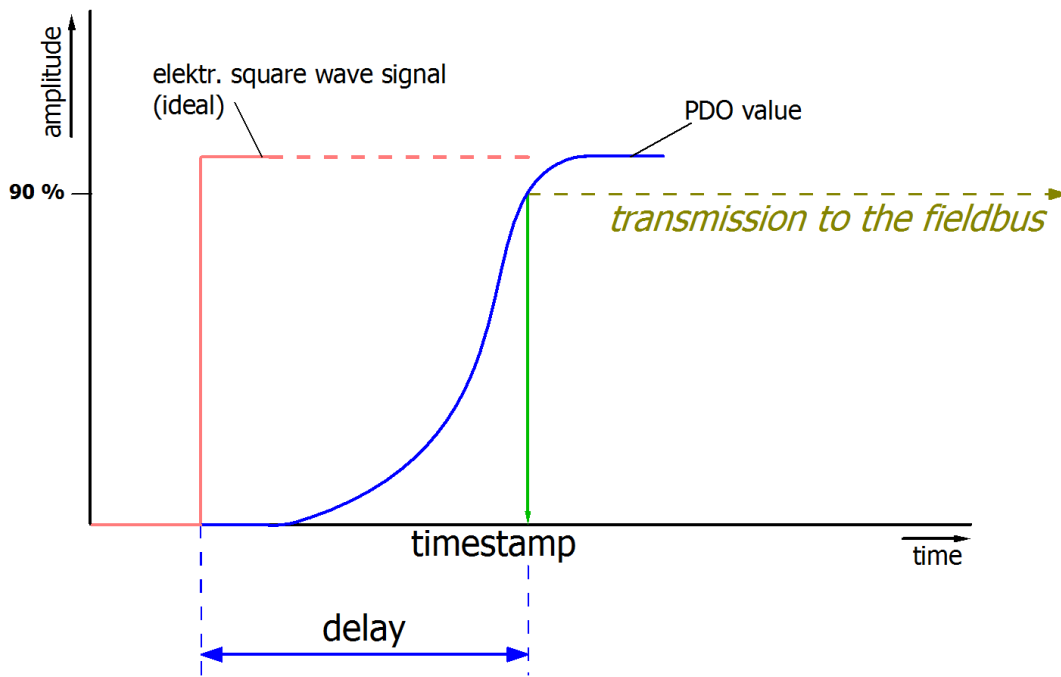

Fig. 160: Diagram signal delay (step response)

2.2 Signal delay (linear)

Keyword: Group delay

Describes the delay of a signal with constant frequency

A test signal can be generated externally with a frequency generator, e.g. as sawtooth or sine. A simultaneous square wave signal would be used as reference.

The signal delay [ms, μ s] is then the interval between the applied electrical signal with a particular amplitude and the moment at which the analog process value reaches the same value.

A meaningful range must be selected for the test frequency, e.g. 1/20 of the maximum sampling rate.

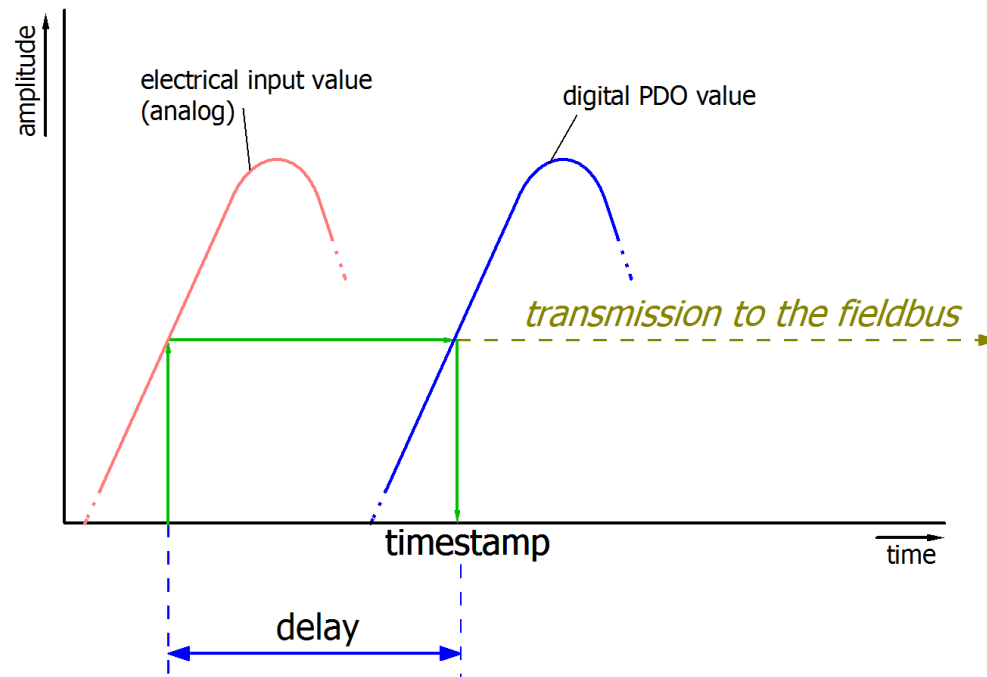

Fig. 161: Diagram signal delay (linear)

3. Additional Information

May be provided in the specification, e.g.

- Actual sampling rate of the ADC (if different from the channel sampling rate)
- Time correction values for run times with different filter settings
- etc.

5.7 Object description and parameterization

● EtherCAT XML Device Description

i The display matches that of the CoE objects from the EtherCAT XML Device Description. We recommend downloading the latest XML file from the download area of the Beckhoff website and installing it according to installation instructions.

● Parameterization via the CoE list (CAN over EtherCAT)

i The EtherCAT device is parameterized via the CoE-Online tab [[▶ 115](#)] (double-click on the respective object) or via the Process Data tab [[▶ 112](#)] (allocation of PDOs). Please note the following general CoE notes [[▶ 32](#)] when using/manipulating the CoE parameters:

- Keep a startup list if components have to be replaced
- Differentiation between online/offline dictionary, existence of current XML description
- use “CoE reload” for resetting changes

Introduction

The CoE overview contains objects for different intended applications:

- Objects required for parameterization during commissioning:
 - Restore object index 0x1011
 - Configuration data index 0x80n0
- Objects intended for regular operation, e.g. through ADS access.
- Profile-specific objects:
 - Configuration data (vendor-specific) index 0x80nF
 - Input data index 0x60n0
 - Information and diagnostic data index 0x80nE, 0xF000, 0xF008, 0xF010
- Standard objects

The following section first describes the objects required for normal operation, followed by a complete overview of missing objects.

5.7.1 Restore object

Index 1011 Restore default parameters

Index (hex)	Name	Meaning	Data type	Flags	Default
1011:0	Restore default parameters [▶ 195]	Restore default parameters	UINT8	RO	0x01 (1 _{dec})
1011:01	SubIndex 001	If this object is set to " 0x64616F6C " in the set value dialog, all backup objects are reset to their delivery state.	UINT32	RW	0x00000000 (0 _{dec})

5.7.2 Configuration data

Index 8027 PM Settings

Index (hex)	Name	Meaning	Data type	Flags	Default		
8027:0	PM Settings		UINT8	RO	>40<		
8027:03	Measuring mode	Measuring method	Value	Description	BIT2	RW	0x00 (0 _{dec})
			0	3-wire connection delta, 4-wire connection star			
			1	reserved			
			2	reserved			
8027:19*	Current range	Current measuring range	0	1 A	BIT4	RW	0x00 (0 _{dec})
			1	0.1 A (presently not active)			
			2	5 A			
8027:28	External CT phase Offset	Correction of the phase shift of external current transformers	The value can be entered within a range of -0.5 radian to +0.5 radian. 1 radian corresponds to 180/φ. Input value = $\Delta \varphi [^\circ] / (90 / \pi) \times 32767$	UINT16	RW	0x000A (0 _{dec})	

*) this object is still supported, but no longer displayed in the CoE. It is preferable to object 0x802D:11.

Index 802D PM Device Settings

Index (hex)	Name	Meaning	Data type	Flags	Default	
802D:0	PM Device Settings	Largest subindex of this object	UINT8	RO	>18<	
802D:11	Current Range	Current measuring range (EL3413)	Current measuring range (EL3433)	BIT4	RW	2 A (200)
		10: 100 mA 100: 1 A 500: 5 A	20: 200 mA 200: 2 A 1000: 10 A			
802D:12	Power calculation threshold	Calculation threshold for power measurement 1: 1% 2: 2% 3: 4% 4: 8%	BIT4	RW	off (0 %)	

5.7.3 Command object

Index FB00 PM Command

The command object is used for triggering an action in the terminal. The command is started by writing subindex 1 (request). Write access is disabled until the current command is completed.

Index (hex)	Name	Meaning	Data type	Flags	Default	
FB00:0	PM Command	Largest subindex of this object	UINT8	RO	>3<	
FB00:01	Request	Byte 0 - service request data	OCTET-STRING[2]	RW	0x0000 (0 _{dec})	
		2 _{hex}				Switch off measurement of the phase
		4 _{hex}				Clear energy [▶ 135]
		12 _{hex}				Switch on phase
		14 _{hex}				Save energy [▶ 135]
		22 _{hex}				Change measuring interval [▶ 133]
		24 _{hex}				Clear energy (autosaved, all channels only)
		34 _{hex}				Save energy (autosaved, all channels only)
		Byte 1 – channel selection / number of periods				
		00 _{hex}				all channels 4 periods
		01 _{hex}				Channel 1 5 periods
		02 _{hex}				Channel 2 10 periods (default)
		03 _{hex}				Channel 3 16 periods
		04 _{hex}				32 periods
FB00:02	Status	byte 0 reserved	UINT8	RW	0x00 (0 _{dec})	
FB00:03	Response	byte 0 reserved	OCTET-STRING[2]	RW	0x00000000 (0 _{dec})	
		byte 1 reserved				
		Byte 2-n reserved				

5.7.4 Configuration data (vendor-specific)

Index 800F PM Vendor data Ch.1

Index (hex)	Name	Meaning	Data type	Flags	Default
800F:0	PM Vendor data Ch.1	Largest subindex of this object	UINT8	RO	>34<
800F:02	EL3413-xxxx: Calibration current gain (1 A)	Vendor calibration EL3413-xxxx: Gain current measuring range, 1 A, channel 1	UINT16	RW	0x4000 (16384 _{dec})
	EL3433-xxxx: Calibration current gain (2 A)	Vendor calibration EL3433-xxxx: Gain current measuring range, 2 A, channel 1			
800F:04	Calibration voltage gain	Vendor calibration: Gain voltage channel 1	UINT16	RW	0x4000 (16384 _{dec})
800F:12	EL3413-xxxx: Calibration current gain (0.1 A)	Vendor calibration EL3413-xxxx: Gain current measuring range, 0.1 A, channel 1	INT16	RW	0x4000 (16384 _{dec})
	EL3433-xxxx: Calibration current gain (0.2 A)	Vendor calibration EL3433-xxxx: Gain current measuring range, 0.2 A, channel 1			
800F:14	EL3413-xxxx: Calibration current gain (5 A)	Vendor calibration EL3413-xxxx: Gain current measuring range, 5 A, channel 1	INT16	RW	0x4000 (16384 _{dec})
	EL3433-xxxx: Calibration current gain (10 A)	Vendor calibration EL3433-xxxx: Gain current measuring range, 10 A, channel 1			
800F:20	EL3413-xxxx: Calibration phase Offset (1 A)	Vendor calibration EL3413-xxxx Phase shift measuring range 1 A, channel 1	UINT16	RW	0x0000 (0 _{dec})
	EL3433-xxxx: Calibration phase Offset (2 A)	Vendor calibration EL3433-xxxx Phase shift measuring range 2 A, channel 1			
800F:21	EL3413-xxxx: Calibration phase Offset (0.1 A)	Vendor calibration EL3413-xxxx Phase shift measuring range 0.1 A, channel 1	UINT16	RW	0x0000 (0 _{dec})
	EL3433-xxxx: Calibration phase Offset (0.2 A)	Vendor calibration EL3433-xxxx Phase shift measuring range 0.2 A, channel 1			
800F:22	EL3413-xxxx: Calibration phase Offset (5 A)	Vendor calibration EL3413-xxxx Phase shift measuring range 5 A, channel 1	UINT16	RW	0x0000 (0 _{dec})
	EL3433-xxxx: Calibration phase Offset (10 A)	Vendor calibration EL3433-xxxx Phase shift measuring range 10 A, channel 1			

Index 801F PM Vendor data Ch.2

Index (hex)	Name	Meaning	Data type	Flags	Default
801F:0	PM Vendor data Ch.2	Largest subindex of this object	UINT8	RO	>34<
801F:02	EL3413-xxxx: Calibration current gain (1 A)	Vendor calibration EL3413-xxxx: Gain current measuring range, 1 A, channel 2	UINT16	RW	0x4000 (16384 _{dec})
	EL3433-xxxx: Calibration current gain (2 A)	Vendor calibration EL3433-xxxx: Gain current measuring range, 2 A, channel 2			
801F:04	Calibration voltage gain	Vendor calibration: Gain voltage channel 2	UINT16	RW	0x4000 (16384 _{dec})
801F:12	EL3413-xxxx: Calibration current gain (0.1 A)	Vendor calibration EL3413-xxxx: Gain current measuring range, 0.1 A, channel 2	INT16	RW	0x4000 (16384 _{dec})
	EL3433-xxxx: Calibration current gain (0.2 A)	Vendor calibration EL3433-xxxx: Gain current measuring range, 0.2 A, channel 2			
801F:14	EL3413-xxxx: Calibration current gain (5 A)	Vendor calibration EL3413-xxxx: Gain current measuring range, 5 A, channel 2	INT16	RW	0x4000 (16384 _{dec})
	EL3433-xxxx: Calibration current gain (10 A)	Vendor calibration EL3433-xxxx: Gain current measuring range, 10 A, channel 2			
801F:20	EL3413-xxxx: Calibration phase Off-set (1 A)	Vendor calibration EL3413-xxxx Phase shift measuring range 1 A, channel 2	UINT16	RW	0x0000 (0 _{dec})
	EL3433-xxxx: Calibration phase Off-set (2 A)	Vendor calibration EL3433-xxxx Phase shift measuring range 2 A, channel 2			
801F:21	EL3413-xxxx: Calibration phase Off-set (0.1 A)	Vendor calibration EL3413-xxxx Phase shift measuring range 0.1 A, channel 2	UINT16	RW	0x0000 (0 _{dec})
	EL3433-xxxx: Calibration phase Off-set (0.2 A)	Vendor calibration EL3433-xxxx Phase shift measuring range 0.2 A, channel 2			
801F:22	EL3413-xxxx: Calibration phase Off-set (5 A)	Vendor calibration EL3413-xxxx Phase shift measuring range 5 A, channel 2	UINT16	RW	0x0000 (0 _{dec})
	EL3433-xxxx: Calibration phase Off-set (10 A)	Vendor calibration EL3433-xxxx Phase shift measuring range 10 A, channel 2			

Index 802F PM Vendor data Ch.3

Index (hex)	Name	Meaning	Data type	Flags	Default
802F:0	PM Vendor data Ch.3	Largest subindex of this object	UINT8	RO	>34<
802F:02	EL3413-xxxx: Calibration current gain (1 A)	Vendor calibration EL3413-xxxx: Gain current measuring range, 1 A, channel 3	UINT16	RW	0x4000 (16384 _{dec})
	EL3433-xxxx: Calibration current gain (2 A)	Vendor calibration EL3433-xxxx: Gain current measuring range, 2 A, channel 3			
802F:04	Calibration voltage gain	Vendor calibration: Gain voltage channel 3	UINT16	RW	0x4000 (16384 _{dec})
802F:12	EL3413-xxxx: Calibration current gain (0.1 A)	Vendor calibration EL3413-xxxx: Gain current measuring range, 0.1 A, channel 3	INT16	RW	0x4000 (16384 _{dec})
	EL3433-xxxx: Calibration current gain (0.2 A)	Vendor calibration EL3433-xxxx: Gain current measuring range, 0.2 A, channel 3			
802F:14	EL3413-xxxx: Calibration current gain (5 A)	Vendor calibration EL3413-xxxx: Gain current measuring range, 5 A, channel 3	INT16	RW	0x4000 (16384 _{dec})
	EL3433-xxxx: Calibration current gain (10 A)	Vendor calibration EL3433-xxxx: Gain current measuring range, 10 A, channel 3			
802F:20	EL3413-xxxx: Calibration phase Off-set (1 A)	Vendor calibration EL3413-xxxx Phase shift measuring range 1 A, channel 3	UINT16	RW	0x0000 (0 _{dec})
	EL3433-xxxx: Calibration phase Off-set (2 A)	Vendor calibration EL3433-xxxx Phase shift measuring range 2 A, channel 3			
802F:21	EL3413-xxxx: Calibration phase Off-set (0.1 A)	Vendor calibration EL3413-xxxx Phase shift measuring range 0.1 A, channel 3	UINT16	RW	0x0000 (0 _{dec})
	EL3433-xxxx: Calibration phase Off-set (0.2 A)	Vendor calibration EL3433-xxxx Phase shift measuring range 0.2 A, channel 3			
802F:22	EL3413-xxxx: Calibration phase Off-set (5 A)	Vendor calibration EL3413-xxxx Phase shift measuring range 5 A, channel 3	UINT16	RW	0x0000 (0 _{dec})
	EL3433-xxxx: Calibration phase Off-set (10 A)	Vendor calibration EL3433-xxxx Phase shift measuring range 10 A, channel 3			

Index 803F PM Vendor data auxiliary

Index (hex)	Name	Meaning	Data type	Flags	Default
803F:0	PM Vendor data Ch.3	Largest subindex of this object	UINT8	RO	>2<
803F:02	Calibration current gain	Vendor calibration Neutral conductor current measurement	UINT16	RW	0x4000 (16384 _{dec})

5.7.5 Input data

Index 6000 PM Inputs Ch.1

Index (hex)	Name	Meaning	Data type	Flags	Default																																																													
6000:0	PM Inputs Ch.1	Largest subindex of this object	UINT8	RO	>29<																																																													
6000:01	Overvoltage	Overvoltage detected EL3413-0000: > 415 V (L1-N) EL3413-0001: > 360 V (L1-N) EL3413-0120: > 130 V (L1-N) EL3433-0000: > 288 V (L1-N)	BOOLEAN	RO	0x00 (0 _{dec})																																																													
6000:02	Undervoltage	Undervoltage detected Voltage < 5 V	BOOLEAN	RO	0x00 (0 _{dec})																																																													
6000:03	Overcurrent	Overcurrent	BOOLEAN	RO	0x00 (0 _{dec})																																																													
6000:05	Phase sequence cw	Phase sequence L1 - L2 - L3 correctly detected (in clockwise 3-phase network)	BOOLEAN	RO	0x00 (0 _{dec})																																																													
6000:06	Phase sequence ccw	Phase sequence L1 - L3 - L2 correctly detected (in counter-clockwise 3-phase network)	BOOLEAN	RO	0x00 (0 _{dec})																																																													
6000:07	Missing zero crossing	No zero crossings detected	BOOLEAN	RO	0x00 (0 _{dec})																																																													
6000:0F	TxPDO State	TRUE in the case of frequency, amplitude or general errors	BOOLEAN	RO	0x00 (0 _{dec})																																																													
6000:10	TxPDO Toggle	The TxPDO toggle is toggled by the slave when the data of the associated TxPDO is updated.	BOOLEAN	RW	0x00 (0 _{dec})																																																													
6000:11	Current	Current channel 1	Unit: 0.000001 A	INT32	RW	0x00000000 (0 _{dec})																																																												
6000:12	Voltage	Voltage channel 1	Unit: 0.0001 V	INT32	RW	0x00000000 (0 _{dec})																																																												
6000:13	Active power	Active power channel 1	Unit: 0.01 W	INT32	RW	0x00000000 (0 _{dec})																																																												
6000:14	Index	Acknowledge for variable output value channel 1	<table border="1"> <thead> <tr> <th>Index (dec)</th> <th>Name</th> <th>Unit</th> </tr> </thead> <tbody> <tr><td>0</td><td>Apparent power</td><td>0.01 VA</td></tr> <tr><td>1</td><td>Reactive power</td><td>0.01 var</td></tr> <tr><td>2</td><td>Energy</td><td>0.001 Wh</td></tr> <tr><td>3</td><td>Power factor λ</td><td>0.001</td></tr> <tr><td>4</td><td>Frequency</td><td>0.1 Hz</td></tr> <tr><td>5</td><td>Energy (negative)</td><td>0.001 Wh</td></tr> <tr><td>6</td><td>Angle α between phase 1 and phase 1</td><td>0.01 °</td></tr> <tr><td>20***</td><td>Active power fundamental (P1)</td><td>0.01 W</td></tr> <tr><td>21***</td><td>Apparent power fundamental (S1)</td><td>0.01 VA</td></tr> <tr><td>22***</td><td>Reactive power fundamental (Q1)</td><td>0.01 var</td></tr> <tr><td>30****</td><td>Energy positive</td><td>0.001 Wh</td></tr> <tr><td>31****</td><td>Positive energy, automatically saved</td><td>0.001 Wh</td></tr> <tr><td>32****</td><td>Energy, automatic saved</td><td>0.001 Wh</td></tr> <tr><td>35****</td><td>Energy negative, automatically saved</td><td>0.001 Wh</td></tr> <tr><td>44***</td><td>Frequency average resolution</td><td>0.01 Hz</td></tr> <tr><td>45***</td><td>Frequency high resolution</td><td>0.001 Hz</td></tr> <tr><td>46*****</td><td>Held frequency</td><td>0.1 Hz</td></tr> <tr><td>47*****</td><td>Held frequency average resolution</td><td>0.01 Hz</td></tr> <tr><td>48*****</td><td>Held frequency high resolution</td><td>0.001 Hz</td></tr> </tbody> </table>	Index (dec)	Name	Unit	0	Apparent power	0.01 VA	1	Reactive power	0.01 var	2	Energy	0.001 Wh	3	Power factor λ	0.001	4	Frequency	0.1 Hz	5	Energy (negative)	0.001 Wh	6	Angle α between phase 1 and phase 1	0.01 °	20***	Active power fundamental (P1)	0.01 W	21***	Apparent power fundamental (S1)	0.01 VA	22***	Reactive power fundamental (Q1)	0.01 var	30****	Energy positive	0.001 Wh	31****	Positive energy, automatically saved	0.001 Wh	32****	Energy, automatic saved	0.001 Wh	35****	Energy negative, automatically saved	0.001 Wh	44***	Frequency average resolution	0.01 Hz	45***	Frequency high resolution	0.001 Hz	46*****	Held frequency	0.1 Hz	47*****	Held frequency average resolution	0.01 Hz	48*****	Held frequency high resolution	0.001 Hz	UINT8	RW	0x00 (0 _{dec})
Index (dec)	Name	Unit																																																																
0	Apparent power	0.01 VA																																																																
1	Reactive power	0.01 var																																																																
2	Energy	0.001 Wh																																																																
3	Power factor λ	0.001																																																																
4	Frequency	0.1 Hz																																																																
5	Energy (negative)	0.001 Wh																																																																
6	Angle α between phase 1 and phase 1	0.01 °																																																																
20***	Active power fundamental (P1)	0.01 W																																																																
21***	Apparent power fundamental (S1)	0.01 VA																																																																
22***	Reactive power fundamental (Q1)	0.01 var																																																																
30****	Energy positive	0.001 Wh																																																																
31****	Positive energy, automatically saved	0.001 Wh																																																																
32****	Energy, automatic saved	0.001 Wh																																																																
35****	Energy negative, automatically saved	0.001 Wh																																																																
44***	Frequency average resolution	0.01 Hz																																																																
45***	Frequency high resolution	0.001 Hz																																																																
46*****	Held frequency	0.1 Hz																																																																
47*****	Held frequency average resolution	0.01 Hz																																																																
48*****	Held frequency high resolution	0.001 Hz																																																																
6000:1D	VariantValue	variable output value channel 1 (see index 0x6000:14 [▶ 158])		INT32	RW	0x00000000 (0 _{dec})																																																												

***) for EL3413 from firmware 08, EL3413-0120 from firmware 04, EL3413-0001/EL3433 from firmware 10
 ****) from firmware 10

Index 6010 PM Inputs Ch.2

Index (hex)	Name	Meaning	Data type	Flags	Default			
6010:0	PM Inputs Ch.2	Largest subindex of this object	UINT8	RO	>29<			
6010:01	Overvoltage	Overvoltage detected EL3413-0000: > 415 V (L1-N) EL3413-0001: > 360 V (L1-N) EL3413-0120: > 130 V (L1-N) EL3433-0000: > 288 V (L1-N)	BOOLEAN	RO	0x00 (0 _{dec})			
6010:02	Undervoltage	Undervoltage detected Voltage < 5 V	BOOLEAN	RO	0x00 (0 _{dec})			
6010:03	Overcurrent	Overcurrent	BOOLEAN	RO	0x00 (0 _{dec})			
6010:05	Phase sequence cw	Phase sequence L1 - L2 - L3 correctly detected (in clockwise 3-phase network)	BOOLEAN	RO	0x00 (0 _{dec})			
6010:06	Phase sequence ccw	Phase sequence L1 - L3 - L2 correctly detected (in counter-clockwise 3-phase network)	BOOLEAN	RO	0x00 (0 _{dec})			
6010:07	Missing zero crossing	No zero crossings detected	BOOLEAN	RO	0x00 (0 _{dec})			
6010:0F	TxPDO State	TRUE in the case of frequency, amplitude or general errors	BOOLEAN	RO	0x00 (0 _{dec})			
6010:10	TxPDO Toggle	The TxPDO toggle is toggled by the slave when the data of the associated TxPDO is updated.	BOOLEAN	RW	0x00 (0 _{dec})			
6010:11	Current	Current channel 2 Unit: 0.000001 A	INT32	RW	0x00000000 (0 _{dec})			
6010:12	Voltage	Voltage channel 2 Unit: 0.0001 V	INT32	RW	0x00000000 (0 _{dec})			
6010:13	Active power	Active power channel 2 Unit: 0.01 W	INT32	RW	0x00000000 (0 _{dec})			
6010:14	Index	Acknowledge for variable output value channel 2	Index (dec)	Name	Unit	UINT8	RW	0x00 (0 _{dec})
			0	Apparent power	0.01 VA			
			1	Reactive power	0.01 var			
			2	Energy	0.001 Wh			
			3	Power factor	0.001			
			4	Frequency	0.1 Hz			
			5	Energy (negative)	0.001 Wh			
			6	Angle α between phase 2 and phase 1	0.01 °			
			20***	Active power fundamental (P1)	0.01 W			
			21***	Apparent power fundamental (S1)	0.01 VA			
			22***	Reactive power fundamental (Q1)	0.01 var			
			30****	Energy positive	0.001 Wh			
			31****	Positive energy, automatically saved	0.001 Wh			
			32****	Energy, automatic saved	0.001 Wh			
			35****	Energy negative, automatically saved	0.001 Wh			
			44***	Frequency average resolution	0.01 Hz			
			45***	Frequency high resolution	0.001 Hz			
46*****	Held frequency	0.1 Hz						
47*****	Held frequency average resolution	0.01 Hz						
48*****	Held frequency high resolution	0.001 Hz						
6010:1D	VariantValue	variable output value channel 2 (see index 0x6010:14 [▶ 159])	INT32	RW	0x00000000 (0 _{dec})			

***) for EL3413 from firmware 08, EL3413-120 from firmware 04, EL3413-1/EL3433 from firmware 10
 ****) from firmware 10

Index 6020 PM Inputs Ch.3

Index (hex)	Name	Meaning	Data type	Flags	Default			
6020:0	PM Inputs Ch.3	Largest subindex of this object	UINT8	RO	>29<			
6020:01	Overvoltage	Overvoltage detected EL3413-0000: > 415 V (L1-N) EL3413-0001: > 360 V (L1-N) EL3413-0120: > 130 V (L1-N) EL3433-0000: > 288 V (L1-N)	BOOLEAN	RO	0x00 (0 _{dec})			
6020:02	Undervoltage	Undervoltage detected Voltage < 5 V	BOOLEAN	RO	0x00 (0 _{dec})			
6020:03	Overcurrent	Overcurrent	BOOLEAN	RO	0x00 (0 _{dec})			
6020:05	Phase sequence cw	Phase sequence L1 - L2 - L3 correctly detected (in clockwise 3-phase network)	BOOLEAN	RO	0x00 (0 _{dec})			
6020:06	Phase sequence ccw	Phase sequence L1 - L3 - L2 correctly detected (in counter-clockwise 3-phase network)	BOOLEAN	RO	0x00 (0 _{dec})			
6020:07	Missing zero crossing	No zero crossings detected	BOOLEAN	RO	0x00 (0 _{dec})			
6020:0F	TxPDO State	TRUE in the case of frequency, amplitude or general errors	BOOLEAN	RO	0x00 (0 _{dec})			
6020:10	TxPDO Toggle	The TxPDO toggle is toggled by the slave when the data of the associated TxPDO is updated.	BOOLEAN	RW	0x00 (0 _{dec})			
6020:11	Current	Current channel 3 Unit: 0.000001 A	INT32	RW	0x00000000 (0 _{dec})			
6020:12	Voltage	Voltage channel 3 Unit: 0.0001 V	INT32	RW	0x00000000 (0 _{dec})			
6020:13	Active power	Active power channel 3 Unit: 0.01 W	INT32	RW	0x00000000 (0 _{dec})			
6020:14	Index	Acknowledge for variable output value channel 3	Index (dec)	Name	Unit	UINT8	RW	0x00 (0 _{dec})
			0	Apparent power	0.01 VA			
			1	Reactive power	0.01 var			
			2	Energy	0.001 Wh			
			3	Power factor	0.001			
			4	Frequency	0.1 Hz			
			5	Energy (negative)	0.001 Wh			
			6	Angle α between phase 3 and phase 1	0.01 °			
			20***	Active power fundamental (P1)	0.01 W			
			21***	Apparent power fundamental (S1)	0.01 VA			
			22***	Reactive power fundamental (Q1)	0.01 var			
			30****	Energy positive	0.001 Wh			
			31****	Positive energy, automatically saved	0.001 Wh			
			32****	Energy, automatic saved	0.001 Wh			
			35****	Energy negative, automatically saved	0.001 Wh			
			44***	Frequency average resolution	0.01 Hz			
45***	Frequency high resolution	0.001 Hz						
46*****	Held frequency	0.1 Hz						
47*****	Held frequency average resolution	0.01 Hz						
48*****	Held frequency high resolution	0.001 Hz						
6020:1D	VariantValue	variable output value channel 3 (see index 0x6020:14 [▶ 160])	INT32	RW	0x00000000 (0 _{dec})			

***) for EL3413 from firmware 08, EL3413-120 from firmware 04, EL3413-1/EL3433 from firmware 10
****) from firmware 10

Index 6030 PM Inputs Auxiliary

Index (hex)	Name	Meaning	Data type	Flags	Default
6030:0	PM Inputs Ch.3	Largest subindex of this object	UINT8	RO	>19<
6030:03	Overcurrent	Overcurrent	BOOLEAN	RO	0x00 (0 _{dec})
6030:0F	TxPDO State	TRUE for general error	BOOLEAN	RO	0x00 (0 _{dec})
6030:10	TxPDO Toggle	The TxPDO toggle is toggled by the slave when the data of the associated TxPDO is updated.	BOOLEAN	RW	0x00 (0 _{dec})
6030:11	Index	Acknowledges for auxiliary variables (see following table)	UINT8	RW	0x00 (0 _{dec})
6030:12	Channel		UINT8	RW	0x00 (0 _{dec})
6030:13	Value	variable output value Aux channel (see index 0x6030:12 [▶ 162])	INT32	RW	0x00000000 (0 _{dec})

Channel (dec)	Index (dec)	Name	Unit
0	0	Neutral conductor current	0.000001 A
0	2	Sum of the energy (channel 1-3)	0.001 Wh
0	4	Frequency	0.1 Hz
0	5	Sum of the energy (negative) (channel 1-3) (absolute value)	0.001 Wh
0	10	Sum of the active power (channel 1-3)	0.01 W
0	11	Sum of the apparent power (channel 1-3)	0.01 VA
0	12	Sum of the reactive power (channel 1-3)	0.01 var
0	20***	Active power fundamental (P1)	0.01 W
0	21***	Apparent power fundamental (S1)	0.01 VA
0	22***	Reactive power fundamental (Q1)	0.01 var
0	30****	Energy positive	0.001 Wh
0	31****	Positive energy, automatically saved	0.001 Wh
0	32****	Energy, automatic saved	0.001 Wh
0	35****	Energy negative, automatically saved (absolute value)	0.001 Wh
0	44***	Frequency average resolution	0.01 Hz
0	45***	Frequency high resolution	0.001 Hz
0	46****	Held frequency	0.1 Hz
0	47****	Held frequency average resolution	0.01 Hz
0	48****	Held frequency high resolution	0.001 Hz
0	100	ADC temperature	0.1°C
1..3	0	Calculation ongoing	
	1..21	RMS value of the xth harmonic (current)	0.000001 A
	51..71	Ratio of the xth harmonic to the fundamental (current)	0.01%
	100	Calculation ongoing	
	101..121	RMS value of the xth harmonic (voltage)	0.0001 V
	151..171	Ratio of the xth harmonic to the fundamental (voltage)	0.01%
11..13	0	Apparent power of phase x	0.01 VA
	1	Reactive power of phase x	0.01 var
	2	Energy of phase x	0.001 Wh
	3	Power factor of phase x	0.001
	4	Frequency of phase x	0.1 Hz
	5	Energy (negative) of phase x (absolute value)	0.001 Wh
	6	Angle α between phase x and phase 1	0.01 °
	10	Active power of phase x	0.01 W
	11	Current of phase x	0.000001 A
	12	Voltage of phase x	0.0001 V
	20***	Active power fundamental (P1)	0.01 W
	21***	Apparent power fundamental (S1)	0.01 VA
	22***	Reactive power fundamental (Q1)	0.01 var
	23***	$\text{Cos Phi} = P_{\text{fund}} / S_{\text{fund}}$ with sign from Q1	0.0001
	44***	Held frequency average resolution	0.01 Hz
45***	Held frequency high resolution	0.001 Hz	

***) for EL3413 from firmware 08, EL3413-0120 from firmware 04, EL3413-1/EL3433 from firmware 10

****) from firmware 10



Calculation of harmonics

It is not possible to calculate harmonics for more than one channel at the same time. Index 00 or 100 is returned until the harmonic calculation has been completed.

5.7.6 Output data

Index 7000 PM Outputs Ch.1

Index (hex)	Name	Meaning	Data type	Flags	Default
7000:0	PM Outputs Ch.1	Largest subindex of this object	UINT8	RO	>1<
7000:01	Index	Request for variable output value channel 1 (see index 0x6000:1D [▶ 158])	UINT8	RW	0x00 (0 _{dec})

Index 7010 PM Outputs Ch.2

Index (hex)	Name	Meaning	Data type	Flags	Default
7010:0	PM Outputs Ch.2	Largest subindex of this object	UINT8	RO	>1<
7010:01	Index	Request for variable output value channel 2 (see index 0x6010:1D [▶ 159])	UINT8	RW	0x00 (0 _{dec})

Index 7020 PM Outputs Ch.3

Index (hex)	Name	Meaning	Data type	Flags	Default
7020:0	PM Outputs Ch.3	Largest subindex of this object	UINT8	RO	>1<
7020:01	Index	Request for variable output value channel 3 (see index 0x6020:1D [▶ 160])	UINT8	RW	0x00 (0 _{dec})

Index 7030 PM Outputs Auxiliary

Index (hex)	Name	Meaning	Data type	Flags	Default
7030:0	PM Outputs Ch.Auxiliary	Largest subindex of this object	UINT8	RO	>2<
7030:01	Index	Request for variable output value channel Aux (see index 0x6030:13 [▶ 162])	UINT8	RW	0x00 (0 _{dec})
7030:02	Channel	Channel selection for variable output value Aux channel (see index 0x6030:13 [▶ 162])	UINT8	RW	0x00 (0 _{dec})

5.7.7 Information and diagnostic data

Index F000 Modular device profile

Index (hex)	Name	Meaning	Data type	Flags	Default
F000:0	Modular device profile	Largest subindex of this object	UINT8	RO	>2<
F000:01	Module index distance	Index distance of the objects of the individual channels	UINT16	RW	0x0010 (16 _{dec})
F000:02	Maximum number of modules	Number of channels	UINT16	RW	0x0004 (4 _{dec})

Index F008 Code word

Index (hex)	Name	Meaning	Data type	Flags	Default
F008:0	Code word	reserved	UINT32	RW	0x00000000 (0 _{dec})

Index F010 Module list

Index (hex)	Name	Meaning	Data type	Flags	Default
F010:0	Module list	Largest subindex of this object	UINT8	RO	>4<
F010:01	Subindex 001	MDP Profile 340	UINT32	RW	0x00000154 (340 _{dec})
F010:02	Subindex 002	MDP Profile 340	UINT32	RW	0x00000154 (340 _{dec})
F010:03	Subindex 003	MDP Profile 340	UINT32	RW	0x00000154 (340 _{dec})
F010:04	Subindex 004	MDP Profile 341	UINT32	RW	0x00000155 (341 _{dec})

Index 9000 PM Persistent data Ch.1

Index (hex)	Name	Meaning	Data type	Flags	Default
9000:0	PM Persistent data Ch.1	Largest subindex of this object	UINT8	RO	>4<
9000:01	Energy (overall)	stored energy value of channel 1 ⁽¹⁾ Unit: 0.001 Wh	INT32	RO	0x00000000 (0 _{dec})
9000:02	Energy (negative)	stored negative energy value of channel 1 ⁽¹⁾ Unit: 0.001 Wh	INT32	RO	0x00000000 (0 _{dec})
9000:03	Energy (overall) autosaved	automatically saved energy value of channel 1 ⁽¹⁾ Unit: 0.001 Wh	INT32	RO	0x00000000 (0 _{dec})
9000:04	Energy (negative) autosaved	automatically saved negative energy value of channel 1 ⁽¹⁾ Unit: 0.001 Wh	INT32	RO	0x00000000 (0 _{dec})

Index 9010 PM Persistent data Ch.2

Index (hex)	Name	Meaning	Data type	Flags	Default
9010:0	PM Persistent data Ch.2	Largest subindex of this object	UINT8	RO	>4<
9010:01	Energy (overall)	stored energy value of channel 2 ⁽¹⁾ Unit: 0.001 Wh	INT32	RO	0x00000000 (0 _{dec})
9010:02	Energy (negative)	stored negative energy value of channel 2 ⁽¹⁾ Unit: 0.001 Wh	INT32	RO	0x00000000 (0 _{dec})
9010:03	Energy (overall) autosaved	automatically saved energy value of channel 2 ⁽¹⁾ Unit: 0.001 Wh	INT32	RO	0x00000000 (0 _{dec})
9010:04	Energy (negative) autosaved	automatically saved negative energy value of channel 2 ⁽¹⁾ Unit: 0.001 Wh	INT32	RO	0x00000000 (0 _{dec})

Index 9020 PM Persistent data Ch.3

Index (hex)	Name	Meaning	Data type	Flags	Default
9020:0	PM Persistent data Ch.3	Largest subindex of this object	UINT8	RO	>4<
9020:01	Energy (overall)	stored energy value of channel 3 ⁽¹⁾ Unit: 0.001 Wh	INT32	RO	0x00000000 (0 _{dec})
9020:02	Energy (negative)	stored negative energy value of channel 3 ⁽¹⁾ Unit: 0.001 Wh	INT32	RO	0x00000000 (0 _{dec})
9020:03	Energy (overall) autosaved	automatically saved energy value of channel 3 ⁽¹⁾ Unit: 0.001 Wh	INT32	RO	0x00000000 (0 _{dec})
9020:04	Energy (negative) autosaved	automatically saved negative energy value of channel 3 ⁽¹⁾ Unit: 0.001 Wh	INT32	RO	0x00000000 (0 _{dec})

⁽¹⁾ The energy values can be saved/deleted using the command object (see index 0xFB00 [► 153]). The negative energy value is the value generated by a negative power (generator mode). The energy value in the variant value for index 3 sets is composed of generated and consumed energy, i.e. in generator mode this value becomes smaller. The two values must be combined in order to calculate the positive energy. From FW 10 the positive energy can be called up via the variant value indices 30/31 (see table in chapter “Energy [► 136]”).

5.7.8 Standard objects

The standard objects have the same meaning for all EtherCAT slaves.

Index 1000 Device type

Index (hex)	Name	Meaning	Data type	Flags	Default
1000:0	Device type	Device type of the EtherCAT slave: the Lo-Word contains the profile used (5001).	UINT32	RO	0x00001389 (5001)

Index 1008 Device name

Index (hex)	Name	Meaning	Data type	Flags	Default
1008:0	Device name	Device name of the EtherCAT slave	STRING	RO	

Index 1009 Hardware version

Index (hex)	Name	Meaning	Data type	Flags	Default
1009:0	Hardware version	Hardware version of the EtherCAT slave	STRING	RO	

Index 100A Software version

Index (hex)	Name	Meaning	Data type	Flags	Default
100A:0	Software version	Firmware version of the EtherCAT slave	STRING	RO	

Index 1018 Identity

Index (hex)	Name	Meaning	Data type	Flags	Default
1018:0	Identity	Length of this object	UINT8	RO	>4<
1018:01	Vendor ID	Vendor ID of the EtherCAT slave	UINT32	RO	0x00000002
1018:02	Product code	Product code of the EtherCAT slave	UINT32	RO	
1018:03	Revision	Revision number of the EtherCAT slave; the low word (bit 0-15) indicates the special terminal number, the high word (bit 16-31) refers to the device description	UINT32	RO	0x00100000 (1048576 _{dec})
1018:04	Serial number	Serial number of the EtherCAT slave; the low byte (bit 0-7) of the low word contains the year of production, the high byte (bit 8-15) of the low word contains the week of production, the high word (bit 16-31) is 0	UINT32	RO	

Index 10F0 Backup parameter

Index (hex)	Name	Meaning	Data type	Flags	Default
10F0:0	Backup parameter	Length of this object	UINT8	RO	>1<
10F0:01	Checksum	Checksum	UINT32	RW	0x00000000 (0 _{dec})

Index 10F3 Diagnosis History

Index (hex)	Name	Meaning	Data type	Flags	Default
10F3:0	Diagnosis History	Maximum subindex	UINT8	RO	>21<
10F3:01	Maximum Messages	Maximum number of stored messages A maximum of 16 messages can be stored	UINT8	RO	0x10 (16 _{dec})
10F3:02	Newest Message	Subindex of the latest message	UINT8	RO	0x00 (0 _{dec})
10F3:03	Newest Acknowledged Message	Subindex of the last confirmed message	UINT8	RW	0x00 (0 _{dec})
10F3:04	New Messages Available	Indicates that a new message is available	BOOLEAN	RO	0x00 (0 _{dec})
10F3:05	Flags	not used	UINT16	RW	0x0000 (0 _{dec})
10F3:06	Diagnosis Message 001	Message 1	OCTET-STRING[28]	RO	{0}
...			
10F3:15	Diagnosis Message 016	Message 16	OCTET-STRING[28]	RO	{0}

Index 10F8 Actual Time Stamp

Index (hex)	Name	Meaning	Data type	Flags	Default
10F8:0	Actual Time Stamp	Time stamp	UINT64	RO	

Index 1600 RxPDO-Map Ch.1

Index (hex)	Name	Meaning	Data type	Flags	Default
1600:0	RxPDO-Map Ch.1	PDO mapping of RxPDO 1	UINT8	RO	>1<
1600:01	SubIndex 001	1. PDO Mapping entry (object 0x7000 (PM Outputs Ch.1), entry 0x01 (Index))	UINT32	RW	0x7000:01, 8

Index 1601 RxPDO-Map Ch.2

Index (hex)	Name	Meaning	Data type	Flags	Default
1601:0	RxPDO-Map Ch.2	PDO mapping of RxPDO 2	UINT8	RO	>1<
1601:01	SubIndex 001	1. PDO Mapping entry (object 0x7010 (PM Outputs Ch.2), entry 0x01 (Index))	UINT32	RW	0x7010:01, 8

Index 1602 RxPDO-Map Ch.3

Index (hex)	Name	Meaning	Data type	Flags	Default
1602:0	RxPDO-Map Ch.3	PDO mapping of RxPDO 3	UINT8	RO	>1<
1602:01	SubIndex 001	1. PDO Mapping entry (object 0x7020 (PM Outputs Ch.3), entry 0x01 (Index))	UINT32	RW	0x7020:01, 8

Index 1603 RxPDO-Map Auxiliary Channel

Index (hex)	Name	Meaning	Data type	Flags	Default
1602:0	RxPDO-Map Ch.3	PDO mapping of RxPDO 3	UINT8	RO	>2<
1603:01	SubIndex 001	1. PDO Mapping entry (object 0x7030 (PM Outputs Ch.3), entry 0x01 (Index))	UINT32	RW	0x7030:01, 8
1603:02	SubIndex 002	1. PDO Mapping entry (object 0x7030 (PM Auxiliary Outputs Ch.3), entry 0x02 (Channel))	UINT32	RW	0x7030:02, 8

Index 1A00 TxPDO-Map Ch.1

Index (hex)	Name	Meaning	Data type	Flags	Default
1A00:0	TxPDO-Map Ch.1	PDO Mapping of TxPDO 1	UINT8	RO	>16<
1A00:01	SubIndex 001	1. PDO Mapping entry (object 0x6000 (PM Inputs Ch.1), entry 0x01 (Undervoltage))	UINT32	RW	0x6000:01, 1
1A00:02	SubIndex 002	2. PDO Mapping entry (object 0x6000 (PM Inputs Ch.1), entry 0x02 (Overvoltage))	UINT32	RW	0x6000:02, 1
1A00:03	SubIndex 003	3. PDO Mapping entry (object 0x6000 (PM Inputs Ch.1), entry 0x03 (Overcurrent))	UINT32	RW	0x6000:03, 1
1A00:04	SubIndex 004	4. PDO Mapping entry (Align)	UINT32	RW	0x0000:00, 1
1A00:05	SubIndex 005	5. PDO Mapping entry (object 0x6000 (PM Inputs Ch.1), entry 0x05 (Phase sequence cw))	UINT32	RW	0x6000:05, 1
1A00:06	SubIndex 006	6. PDO Mapping entry (object 0x6000 (PM Inputs Ch.1), entry 0x06 (Phase sequence cw))	UINT32	RW	0x6000:06, 1
1A00:07	SubIndex 007	7. PDO Mapping entry (object 0x6000 (PM Inputs Ch.1), entry 0x07 (Missing zero crossing))	UINT32	RW	0x6000:07, 1
1A00:08	SubIndex 008	8. PDO Mapping entry (Align)	UINT32	RW	0x0000:00, 7
1A00:09	SubIndex 009	9. PDO Mapping entry (object 0x6000 (PM Inputs Ch.1), entry 0x0F (TxPDO State))	UINT32	RW	0x6000:0F, 1
1A00:0A	SubIndex 010	10. PDO Mapping entry (object 0x6000 (AI Inputs Ch.1), entry 0x10 (TxPDO Toggle))	UINT32	RW	0x6000:10, 1
1A00:0B	SubIndex 011	11. PDO Mapping entry (object 0x6000 (PM Inputs Ch.1), entry 0x11 (Current))	UINT32	RW	0x6000:11, 32
1A00:0C	SubIndex 012	12. PDO Mapping entry (object 0x6000 (PM Inputs Ch.1), entry 0x12 (Voltage))	UINT32	RW	0x6000:12, 32
1A00:0D	SubIndex 013	13. PDO Mapping entry (object 0x6000 (PM Inputs Ch.1), entry 0x13 (Active power))	UINT32	RW	0x6000:13, 32
1A00:0E	SubIndex 014	14. PDO Mapping entry (object 0x6000 (PM Inputs Ch.1), entry 0x14 (Index))	UINT32	RW	0x6000:14, 8
1A00:0F	SubIndex 015	15. PDO Mapping entry (Align)	UINT32	RW	0x0000:00, 8
1A00:10	SubIndex 016	16. PDO Mapping entry (object 0x6000 (PM Inputs Ch.1), entry 0x1D (VariantValue))	UINT32	RW	0x6000:1D, 32

Index 1A01 TxPDO-Map Ch.2

Index (hex)	Name	Meaning	Data type	Flags	Default
1A01:0	TxPDO-Map Ch.2	PDO Mapping of TxPDO 2	UINT8	RO	>16<
1A01:01	SubIndex 001	1. PDO Mapping entry (object 0x6010 (PM Inputs Ch.1), entry 0x01 (Undervoltage))	UINT32	RW	0x6010:01, 1
1A01:02	SubIndex 002	2. PDO Mapping entry (object 0x6010 (PM Inputs Ch.1), entry 0x02 (Overvoltage))	UINT32	RW	0x6010:02, 1
1A01:03	SubIndex 003	3. PDO Mapping entry (object 0x6010 (PM Inputs Ch.1), entry 0x03 (Overcurrent))	UINT32	RW	0x6010:03, 1
1A01:04	SubIndex 004	4. PDO Mapping entry (Align)	UINT32	RW	0x0000:00, 1
1A01:05	SubIndex 005	5. PDO Mapping entry (object 0x6010 (PM Inputs Ch.1), entry 0x05 (Phase sequence cw))	UINT32	RW	0x6010:05, 1
1A01:06	SubIndex 006	6. PDO Mapping entry (object 0x6010 (PM Inputs Ch.1), entry 0x06 (Phase sequence ccw))	UINT32	RW	0x6010:06, 1
1A01:07	SubIndex 007	7. PDO Mapping entry (object 0x6010 (PM Inputs Ch.1), entry 0x07 (Missing zero crossing))	UINT32	RW	0x6010:07, 1
1A01:08	SubIndex 008	8. PDO Mapping entry (Align)	UINT32	RW	0x0000:00, 7
1A01:09	SubIndex 009	9. PDO Mapping entry (object 0x6010 (PM Inputs Ch.1), entry 0x0F (TxPDO State))	UINT32	RW	0x6010:0F, 1
1A01:0A	SubIndex 010	10. PDO Mapping entry (object 0x6010 (PM Inputs Ch.1), entry 0x10 (TxPDO Toggle))	UINT32	RW	0x6010:10, 1
1A01:0B	SubIndex 011	11. PDO Mapping entry (object 0x6010 (PM Inputs Ch.1), entry 0x11 (Current))	UINT32	RW	0x6010:11, 32
1A01:0C	SubIndex 012	12. PDO Mapping entry (object 0x6010 (PM Inputs Ch.1), entry 0x12 (Voltage))	UINT32	RW	0x6010:12, 32
1A01:0D	SubIndex 013	13. PDO Mapping entry (object 0x6010 (PM Inputs Ch.1), entry 0x13 (Active power))	UINT32	RW	0x6010:13, 32
1A01:0E	SubIndex 014	14. PDO Mapping entry (object 0x6010 (PM Inputs Ch.1), entry 0x14 (Index))	UINT32	RW	0x6010:14, 8
1A01:0F	SubIndex 015	15. PDO Mapping entry (Align)	UINT32	RW	0x0000:00, 8
1A01:10	SubIndex 016	16. PDO Mapping entry (object 0x6010 (PM Inputs Ch.1), entry 0x1D (VariantValue))	UINT32	RW	0x6010:1D, 32

Index 1A02 TxPDO-Map Ch.3

Index (hex)	Name	Meaning	Data type	Flags	Default
1A02:0	TxPDO-Map Ch.3	PDO Mapping of TxPDO 3	UINT8	RO	>16<
1A02:01	SubIndex 001	1. PDO Mapping entry (object 0x6020 (PM Inputs Ch.1), entry 0x01 (Undervoltage))	UINT32	RW	0x6020:01, 1
1A02:02	SubIndex 002	2. PDO Mapping entry (object 0x6020 (PM Inputs Ch.1), entry 0x02 (Overvoltage))	UINT32	RW	0x6020:02, 1
1A02:03	SubIndex 003	3. PDO Mapping entry (object 0x6020 (PM Inputs Ch.1), entry 0x03 (Overcurrent))	UINT32	RW	0x6020:03, 1
1A02:04	SubIndex 004	4. PDO Mapping entry (Align)	UINT32	RW	0x0000:00, 1
1A02:05	SubIndex 005	5. PDO Mapping entry (object 0x6020 (PM Inputs Ch.1), entry 0x05 (Phase sequence cw))	UINT32	RW	0x6020:05, 1
1A02:06	SubIndex 006	6. PDO Mapping entry (object 0x6020 (PM Inputs Ch.1), entry 0x06 (Phase sequence ccw))	UINT32	RW	0x6020:06, 1
1A02:07	SubIndex 007	7. PDO Mapping entry (object 0x6020 (PM Inputs Ch.1), entry 0x07 (Missing zero crossing))	UINT32	RW	0x6020:07, 1
1A02:08	SubIndex 008	8. PDO Mapping entry (Align)	UINT32	RW	0x0000:00, 7
1A02:09	SubIndex 009	9. PDO Mapping entry (object 0x6020 (PM Inputs Ch.1), entry 0x0F (TxPDO State))	UINT32	RW	0x6020:0F, 1
1A02:0A	SubIndex 010	10. PDO Mapping entry (object 0x6020 (PM Inputs Ch.1), entry 0x10 (TxPDO Toggle))	UINT32	RW	0x6020:10, 1
1A02:0B	SubIndex 011	11. PDO Mapping entry (object 0x6020 (PM Inputs Ch.1), entry 0x11 (Current))	UINT32	RW	0x6020:11, 32
1A02:0C	SubIndex 012	12. PDO Mapping entry (object 0x6020 (PM Inputs Ch.1), entry 0x12 (Voltage))	UINT32	RW	0x6020:12, 32
1A02:0D	SubIndex 013	13. PDO Mapping entry (object 0x6020 (PM Inputs Ch.1), entry 0x13 (Active power))	UINT32	RW	0x6020:13, 32
1A02:0E	SubIndex 014	14. PDO Mapping entry (object 0x6020 (PM Inputs Ch.1), entry 0x14 (Index))	UINT32	RW	0x6020:14, 8
1A02:0F	SubIndex 015	15. PDO Mapping entry (Align)	UINT32	RW	0x0000:00, 8
1A02:10	SubIndex 016	16. PDO Mapping entry (object 0x6020 (PM Inputs Ch.1), entry 0x1D (VariantValue))	UINT32	RW	0x6020:1D, 32

Index 1A03 TxPDO-Map Auxiliary

Index (hex)	Name	Meaning	Data type	Flags	Default
1A03:0	TxPDO-Map Auxiliary	PDO Mapping of TxPDO 4	UINT8	RO	>8<
1A03:01	SubIndex 001	1. PDO Mapping entry (Align)	UINT32	RW	0x0000:00, 2
1A03:02	SubIndex 002	2. PDO Mapping entry (object 0x6030 (PM Auxiliary), entry 0x03 (Overcurrent))	UINT32	RW	0x6030:03, 1
1A03:03	SubIndex 003	3. PDO Mapping entry (Align)	UINT32	RW	0x0000:00, 11
1A03:04	SubIndex 004	4. PDO Mapping entry (object 0x6030 (PM Auxiliary), entry 0x0F (TxPDO State))	UINT32	RW	0x6030:0F, 1
1A03:05	SubIndex 005	5. PDO Mapping entry (object 0x6030 (PM Auxiliary), entry 0x10 (TxPDO Toggle))	UINT32	RW	0x6030:10, 1
1A03:06	SubIndex 005	6. PDO Mapping entry (object 0x6030 (PM Auxiliary), entry 0x11 (Index))	UINT32	RW	0x6030:11, 8
1A03:07	SubIndex 005	7. PDO Mapping entry (object 0x6030 (PM Auxiliary), entry 0x12 (Channel))	UINT32	RW	0x6030:12, 8
1A03:08	SubIndex 005	8. PDO Mapping entry (object 0x6030 (PM Auxiliary), entry 0x13 (Value))	UINT32	RW	0x6030:13, 32

Index 1C00 Sync manager type

Index (hex)	Name	Meaning	Data type	Flags	Default
1C00:0	Sync manager type	Length of this object	UINT8	RO	>4<
1C00:01	SubIndex 001	Sync-Manager Type Channel 1: Mailbox Write	UINT8	RW	0x01 (1 _{dec})
1C00:02	SubIndex 002	Sync-Manager Type Channel 2: Mailbox Read	UINT8	RW	0x02 (2 _{dec})
1C00:03	SubIndex 003	Sync-Manager Type Channel 3: Process Data Write (Outputs)	UINT8	RW	0x03 (3 _{dec})
1C00:04	SubIndex 004	Sync-Manager Type Channel 4: Process Data Read (Inputs)	UINT8	RW	0x04 (4 _{dec})

Index 1C12 RxPDO assign

Index (hex)	Name	Meaning	Data type	Flags	Default
1C12:0	RxPDO assign	PDO Assign of the Outputs	UINT8	RO	>4<
1C32:01	Subindex 001	1. assigned PDO (RxPDO-Map Ch.1 (RxPDO 1))	UINT16	RW	0x1600 (5632 _{dec})
1C12:02	Subindex 002	2. assigned PDO (RxPDO-Map Ch.2 (RxPDO 2))	UINT16	RW	0x1601 (5633 _{dec})
1C12:03	Subindex 003	3. assigned PDO (RxPDO-Map Ch.3 (RxPDO 3))	UINT16	RW	0x1602 (5634 _{dec})
1C12:04	Subindex 004	4. assigned PDO (RxPDO-Map Auxiliary (RxPDO 4))	UINT16	RW	0x1603 (5634 _{dec})

Index 1C13 TxPDO assign

Index (hex)	Name	Meaning	Data type	Flags	Default
1C13:0	TxPDO assign	PDO Assign of the Inputs	UINT8	RO	>4<
1C13:01	Subindex 001	1. assigned PDO (TxPDO-Map Ch.1 (TxPDO 1))	UINT16	RW	0x1A00 (6656 _{dec})
1C13:02	Subindex 002	2. assigned PDO (TxPDO-Map Ch.2 (TxPDO 2))	UINT16	RW	0x1A01 (6657 _{dec})
1C13:03	Subindex 003	3. assigned PDO (TxPDO-Map Ch.3 (TxPDO 3))	UINT16	RW	0x1A02 (6658 _{dec})
1C13:04	Subindex 004	4. assigned PDO (TxPDO-Map Auxiliary (TxPDO 4))	UINT16	RW	0x1A03 (6659 _{dec})

Index 1C32 SM output parameter

Index (hex)	Name	Meaning	Data type	Flags	Default
1C32:0	SM output parameter	Synchronization parameters for the outputs	UINT8	RO	>32<
1C32:01	Sync mode	Current synchronization mode: <ul style="list-style-type: none"> • 0: Free Run • 1: Synchron with SM 2 Event • 2: DC-Mode - Synchron with SYNC0 Event • 3: DC-Mode - Synchron with SYNC1 Event 	UINT16	RW	0x0000 (0 _{dec})
1C32:02	Cycle time	Cycle time (in ns): <ul style="list-style-type: none"> • Free Run: Cycle time of the local timer • Synchron with SM 2 Event: Master cycle time • DC mode: SYNC0/SYNC1 Cycle Time 	UINT32	RW	0x000AAE60 (700000 _{dec})
1C32:03	Shift time	Time between SYNC0 event and output of the outputs (in ns, DC mode only)	UINT32	RW	0x00000000 (0 _{dec})
1C32:04	Sync modes supported	Supported synchronization modes: <ul style="list-style-type: none"> • Bit 0 = 1: free run is supported • Bit 1 = 1: Synchronous with SM 2 event is supported • Bit 2-3 = 01: DC mode is supported • Bit 4-5 = 10: Output shift with SYNC1 event (only DC mode) • Bit 14 = 1: dynamic times (measurement through writing of 0x1C32:08 [▶ 171]) 	UINT16	RW	0x0001 (1 _{dec})
1C32:05	Minimum cycle time	Minimum cycle time (in ns)	UINT32	RW	0x000AAE60 (700000 _{dec})
1C32:06	Calc and copy time	Minimum time between SYNC0 and SYNC1 event (in ns, DC mode only)	UINT32	RW	0x00000000 (0 _{dec})
1C32:08	Command	<ul style="list-style-type: none"> • 0: Measurement of the local cycle time is stopped • 1: Measurement of the local cycle time is started 0x1C32:033 [▶ 171], 0x1C32:05 [▶ 171], 0x1C32:06 [▶ 171], 0x1C32:09 [▶ 171], 0x1C33:03 [▶ 172], 0x1C33:06 [▶ 171], 0x1C33:09 [▶ 172] are updated with the maximum measured values. For a subsequent measurement the measured values are reset	UINT16	RW	0x0000 (0 _{dec})
1C32:09	Delay time	Time between SYNC1 event and output of the outputs (in ns, DC mode only)	UINT32	RW	0x00000000 (0 _{dec})
1C32:0B	SM event missed counter	Number of missed SM events in OPERATIONAL (DC mode only)	UINT166	RW	0x0000 (0 _{dec})
1C32:0C	Cycle exceeded counter	Number of occasions the cycle time was exceeded in OPERATIONAL (cycle was not completed in time or the next cycle began too early)	UINT16	RW	0x0000 (0 _{dec})
1C32:0D	Shift too short counter	Number of occasions that the interval between SYNC0 and SYNC1 event was too short (DC mode only)	UINT16	RW	0x0000 (0 _{dec})
1C32:20	Sync error	The synchronization was not correct in the last cycle (outputs were output too late; DC mode only)	BOOLEAN	RW	0x00 (0 _{dec})

Index 1C33 SM input parameter

Index (hex)	Name	Meaning	Data type	Flags	Default
1C33:0	SM input parameter	Synchronization parameters for the inputs	UINT8	RO	>32<
1C33:01	Sync mode	Current synchronization mode: <ul style="list-style-type: none"> • 0: Free Run • 1: Synchron with SM 3 event (no outputs available) • 2: DC - Synchron with SYNC0 Event • 3: DC - Synchron with SYNC1 Event • 34: Synchron with SM 2 Event (outputs available) 	UINT16	RW	0x0000 (0 _{dec})
1C33:02	Cycle time	as 0x1C32:02 [▶ 171]	UINT32	RW	0x000AAE60 (700000 _{dec})
1C33:03	Shift time	Time between SYNC0 event and reading of the inputs (in ns, only DC mode)	UINT32	RW	0x00000000 (0 _{dec})
1C33:04	Sync modes supported	Supported synchronization modes: <ul style="list-style-type: none"> • Bit 0: free run is supported • Bit 1: Synchron with SM 2 Event is supported (outputs available) • Bit 1: Synchron with SM 3 Event is supported (no outputs available) • Bit 2-3 = 01: DC mode is supported • Bit 4-5 = 01: Input shift through local event (outputs available) • Bit 4-5 = 10: Input shift with SYNC1 event (no outputs available) • Bit 14 = 1: dynamic times (measurement through writing of 0x1C32:08 [▶ 171] or 0x1C33:08 [▶ 172]) 	UINT16	RW	0x0001 (1 _{dec})
1C33:05	Minimum cycle time	as 0x1C32:05 [▶ 171]	UINT32	RW	0x000AAE60 (700000 _{dec})
1C33:06	Calc and copy time	Time between reading of the inputs and availability of the inputs for the master (in ns, only DC mode)	UINT32	RW	0x00000000 (0 _{dec})
1C33:08	Command	as 0x1C32:08 [▶ 171]	UINT16	RW	0x0000 (0 _{dec})
1C33:09	Delay time	Time between SYNC1 event and reading of the inputs (in ns, only DC mode)	UINT32	RW	0x00000000 (0 _{dec})
1C33:0B	SM event missed counter	as 0x1C32:0B [▶ 171]	UINT16	RW	0x0000 (0 _{dec})
1C33:0C	Cycle exceeded counter	as 0x1C32:0C [▶ 171]	UINT16	RW	0x0000 (0 _{dec})
1C33:0D	Shift too short counter	as 0x1C32:0D [▶ 171]	UINT16	RW	0x0000 (0 _{dec})
1C33:20	Sync error	as 0x1C32:20 [▶ 171]	BOOLEAN	RWW	0x00 (0 _{dec})

6 Diagnostics – basic principles of diag messages

DiagMessages designates a system for the transmission of messages from the EtherCAT Slave to the EtherCAT Master/TwinCAT. The messages are stored by the device in its own CoE under 0x10F3 and can be read by the application or the System Manager. An error message referenced via a code is output for each event stored in the device (warning, error, status change).

Definition

The *DiagMessages* system is defined in the ETG (EtherCAT Technology Group) in the guideline ETG.1020, chapter 13 "Diagnosis handling". It is used so that pre-defined or flexible diagnostic messages can be conveyed from the EtherCAT Slave to the Master. In accordance with the ETG, the process can therefore be implemented supplier-independently. Support is optional. The firmware can store up to 250 *DiagMessages* in its own CoE.

Each *DiagMessage* consists of

- Diag Code (4-byte)
- Flags (2-byte; info, warning or error)
- Text ID (2-byte; reference to explanatory text from the ESI/XML)
- Timestamp (8-byte, local slave time or 64-bit Distributed Clock time, if available)
- Dynamic parameters added by the firmware

The *DiagMessages* are explained in text form in the ESI/XML file belonging to the EtherCAT device: on the basis of the Text ID contained in the *DiagMessage*, the corresponding plain text message can be found in the languages contained in the ESI/XML. In the case of Beckhoff products these are usually German and English.

Via the entry *NewMessagesAvailable* the user receives information that new messages are available.

DiagMessages can be confirmed in the device: the last/latest unconfirmed message can be confirmed by the user.

In the CoE both the control entries and the history itself can be found in the CoE object 0x10F3:

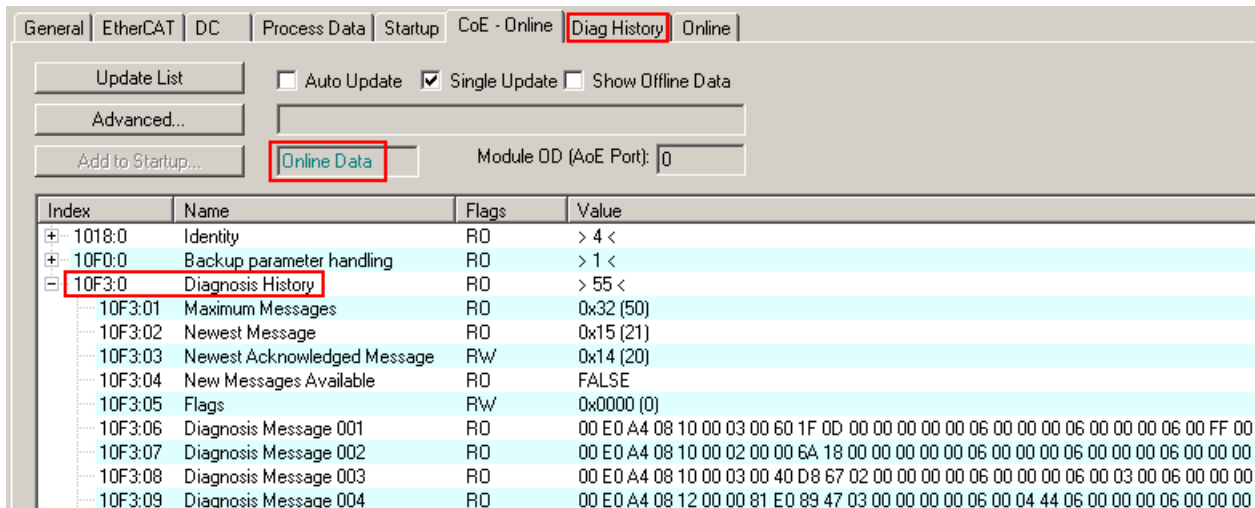

Fig. 162: *DiagMessages* in the CoE

The subindex of the latest *DiagMessage* can be read under x10F3:02.

i Support for commissioning

The *DiagMessages* system is to be used above all during the commissioning of the plant. The diagnostic values e.g. in the StatusWord of the device (if available) are helpful for online diagnosis during the subsequent continuous operation.

TwinCAT System Manager implementation

From TwinCAT 2.11 DiagMessages, if available, are displayed in the device's own interface. Operation (collection, confirmation) also takes place via this interface.

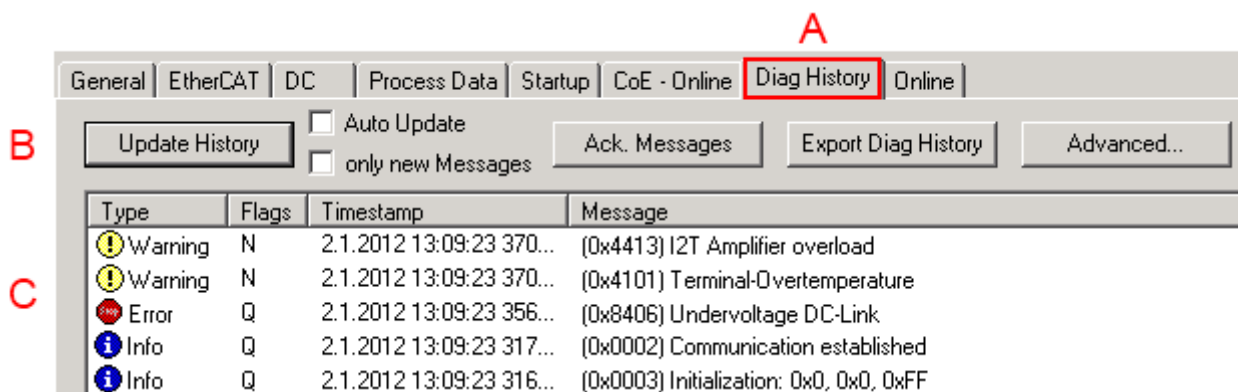

Fig. 163: Implementation of the DiagMessage system in the TwinCAT System Manager

The operating buttons (B) and the history read out (C) can be seen on the Diag History tab (A). The components of the message:

- Info/Warning/Error
- Acknowledge flag (N = unconfirmed, Q = confirmed)
- Time stamp
- Text ID
- Plain text message according to ESI/XML data

The meanings of the buttons are self-explanatory.

DiagMessages within the ADS Logger/Eventlogger

Since TwinCAT 3.1 build 4022 DiagMessages send by the terminal are shown by the TwinCAT ADS Logger. Given that DiagMessages are represented IO- comprehensive at one place, commissioning will be simplified. In addition, the logger output could be stored into a data file – hence DiagMessages are available long-term for analysis.

Reading messages into the PLC

- In preparation -

Interpretation

Time stamp

The time stamp is obtained from the local clock of the terminal at the time of the event. The time is usually the distributed clock time (DC) from register x910.

Please note: When EtherCAT is started, the DC time in the reference clock is set to the same time as the local IPC/TwinCAT time. From this moment the DC time may differ from the IPC time, since the IPC time is not adjusted. Significant time differences may develop after several weeks of operation without a EtherCAT restart. As a remedy, external synchronization of the DC time can be used, or a manual correction calculation can be applied, as required: The current DC time can be determined via the EtherCAT master or from register x901 of the DC slave.

Structure of the Text ID

The structure of the MessageID is not subject to any standardization and can be supplier-specifically defined. In the case of Beckhoff EtherCAT devices (EL, EP) it usually reads according to **xyzz**:

x	y	zz
0: Systeminfo 2: reserved 1: Info 4: Warning 8: Error	0: System 1: General 2: Communication 3: Encoder 4: Drive 5: Inputs 6: I/O general 7: reserved	Error number

Example: Message 0x4413 --> Drive Warning Number 0x13

Overview of text IDs

Specific Text IDs should be specified in the device documentation.

Text ID	Type	Place	Text Message	Additional comment
0x0001	Information	System	No error	No error
0x0002	Information	System	Communication established	Connection established
0x0003	Information	System	Initialization: 0x%X, 0x%X, 0x%X	General information; parameters depend on event. See device documentation for interpretation.
0x1000	Information	System	Information: 0x%X, 0x%X, 0x%X	General information; parameters depend on event. See device documentation for interpretation.
0x1012	Information	System	EtherCAT state change Init - PreOp	
0x1021	Information	System	EtherCAT state change PreOp - Init	
0x1024	Information	System	EtherCAT state change PreOp - Safe-Op	
0x1042	Information	System	EtherCAT state change SafeOp - PreOp	
0x1048	Information	System	EtherCAT state change SafeOp - Op	
0x1084	Information	System	EtherCAT state change Op - SafeOp	
0x1100	Information	General	Detection of operation mode completed: 0x%X, %d	Detection of the mode of operation ended
0x1135	Information	General	Cycle time o.k.: %d	Cycle time OK
0x1157	Information	General	Data manually saved (Idx: 0x%X, SubIdx: 0x%X)	Data saved manually
0x1158	Information	General	Data automatically saved (Idx: 0x%X, SubIdx: 0x%X)	Data saved automatically
0x1159	Information	General	Data deleted (Idx: 0x%X, SubIdx: 0x%X)	Data deleted
0x117F	Information	General	Information: 0x%X, 0x%X, 0x%X	Information
0x1201	Information	Communication	Communication re-established	Communication to the field side restored This message appears, for example, if the voltage was removed from the power contacts and re-applied during operation
0x1300	Information	Encoder	Position set: %d, %d	Position set - StartInputhandler
0x1303	Information	Encoder	Encoder Supply ok	Encoder power supply unit OK
0x1304	Information	Encoder	Encoder initialization successfully, channel: %X	Encoder initialization successfully completed
0x1305	Information	Encoder	Sent command encoder reset, channel: %X	Send encoder reset command
0x1400	Information	Drive	Drive is calibrated: %d, %d	Drive is calibrated
0x1401	Information	Drive	Actual drive state: 0x%X, %d	Current drive status
0x1705	Information		CPU usage returns in normal range (< 85%%)	Processor load is back in the normal range
0x1706	Information		Channel is not in saturation anymore	Channel is no longer in saturation
0x1707	Information		Channel is not in overload anymore	Channel is no longer overloaded
0x170A	Information		No channel range error anymore	A measuring range error is no longer active
0x170C	Information		Calibration data saved	Calibration data were saved
0x170D	Information		Calibration data will be applied and saved after sending the command "0x5AFE"	Calibration data are not applied and saved until the command "0x5AFE" is sent

Text ID	Type	Place	Text Message	Additional comment
0x2000	Information	System	%s: %s	
0x2001	Information	System	%s: Network link lost	Network connection lost
0x2002	Information	System	%s: Network link detected	Network connection found
0x2003	Information	System	%s: no valid IP Configuration - Dhcp client started	Invalid IP configuration
0x2004	Information	System	%s: valid IP Configuration (IP: %d.%d.%d.%d) assigned by Dhcp server %d.%d.%d.%d	Valid IP configuration, assigned by the DHCP server
0x2005	Information	System	%s: Dhcp client timed out	DHCP client timeout
0x2006	Information	System	%s: Duplicate IP Address detected (%d.%d.%d.%d)	Duplicate IP address found
0x2007	Information	System	%s: UDP handler initialized	UDP handler initialized
0x2008	Information	System	%s: TCP handler initialized	TCP handler initialized
0x2009	Information	System	%s: No more free TCP sockets available	No free TCP sockets available.

Text ID	Type	Place	Text Message	Additional comment
0x4000	Warning		Warning: 0x%X, 0x%X, 0x%X	General warning; parameters depend on event. See device documentation for interpretation.
0x4001	Warning	System	Warning: 0x%X, 0x%X, 0x%X	
0x4002	Warning	System	%s: %s Connection Open (IN:%d OUT:%d API:%dms) from %d.%d.%d.%d successful	
0x4003	Warning	System	%s: %s Connection Close (IN:%d OUT:%d) from %d.%d.%d.%d successful	
0x4004	Warning	System	%s: %s Connection (IN: %d OUT:%d) with %d.%d.%d timed out	
0x4005	Warning	System	%s: %s Connection Open (IN:%d OUT:%d) from %d.%d.%d.%d denied (Error: %u)	
0x4006	Warning	System	%s: %s Connection Open (IN:%d OUT:%d) from %d.%d.%d.%d denied (Input Data Size expected: %d Byte(s) received: %d Byte(s))	
0x4007	Warning	System	%s: %s Connection Open (IN:%d OUT:%d) from %d.%d.%d.%d denied (Output Data Size expected: %d Byte(s) received: %d Byte(s))	
0x4008	Warning	System	%s: %s Connection Open (IN:%d OUT:%d) from %d.%d.%d.%d denied (RPI:%dms not supported -> API:%dms)	
0x4101	Warning	General	Terminal-Overtemperature	Overtemperature. The internal temperature of the terminal exceeds the parameterized warning threshold
0x4102	Warning	General	Discrepancy in the PDO-Configuration	The selected PDOs do not match the set operating mode. Sample: Drive operates in velocity mode, but the velocity PDO is but not mapped in the PDOs.
0x417F	Warning	General	Warning: 0x%X, 0x%X, 0x%X	
0x428D	Warning	General	Challenge is not Random	
0x4300	Warning	Encoder	Subincrements deactivated: %d, %d	Sub-increments deactivated (despite activated configuration)
0x4301	Warning	Encoder	Encoder-Warning	General encoder error
0x4400	Warning	Drive	Drive is not calibrated: %d, %d	Drive is not calibrated
0x4401	Warning	Drive	Starttype not supported: 0x%X, %d	Start type is not supported
0x4402	Warning	Drive	Command rejected: %d, %d	Command rejected
0x4405	Warning	Drive	Invalid modulo subtype: %d, %d	Modulo sub-type invalid
0x4410	Warning	Drive	Target overrun: %d, %d	Target position exceeded
0x4411	Warning	Drive	DC-Link undervoltage (Warning)	The DC link voltage of the terminal is lower than the parameterized minimum voltage. Activation of the output stage is prevented
0x4412	Warning	Drive	DC-Link overvoltage (Warning)	The DC link voltage of the terminal is higher than the parameterized maximum voltage. Activation of the output stage is prevented
0x4413	Warning	Drive	I2T-Model Amplifier overload (Warning)	- The amplifier is being operated outside the specification - The I2T-model of the amplifier is incorrectly parameterized

Text ID	Type	Place	Text Message	Additional comment
0x4414	Warning	Drive	I2T-Model Motor over-load (Warning)	- The motor is being operated outside the parameterized rated values - The I2T-model of the motor is incorrectly parameterized
0x4415	Warning	Drive	Speed limitation active	The maximum speed is limited by the parameterized objects (e.g. velocity limitation, motor speed limitation). This warning is output if the set velocity is higher than one of the parameterized limits
0x4416	Warning	Drive	Step lost detected at position: 0x%X%X	Step loss detected
0x4417	Warning	Drive	Motor overtemperature	The internal temperature of the motor exceeds the parameterized warning threshold
0x4418	Warning	Drive	Limit: Current	Limit: current is limited
0x4419	Warning	Drive	Limit: Amplifier I2T-model exceeds 100%%	The threshold values for the maximum current were exceeded.
0x441A	Warning	Drive	Limit: Motor I2T-model exceeds 100%%	Limit: Motor I2T-model exceeds 100%
0x441B	Warning	Drive	Limit: Velocity limitation	The threshold values for the maximum speed were exceeded.
0x441C	Warning	Drive	STO while the axis was enabled	An attempt was made to activate the axis, despite the fact that no voltage is present at the STO input.
0x4600	Warning	General IO	Wrong supply voltage range	Supply voltage not in the correct range
0x4610	Warning	General IO	Wrong output voltage range	Output voltage not in the correct range
0x4705	Warning		Processor usage at %d %%	Processor load at %d %%
0x470A	Warning		EtherCAT Frame missed (change Settings or DC Operation Mode or Sync0 Shift Time)	EtherCAT frame missed (change DC Operation Mode or Sync0 Shift Time under Settings)

Text ID	Type	Place	Text Message	Additional comment
0x8000	Error	System	%s: %s	
0x8001	Error	System	Error: 0x%X, 0x%X, 0x%X	General error; parameters depend on event. See device documentation for interpretation.
0x8002	Error	System	Communication aborted	Communication aborted
0x8003	Error	System	Configuration error: 0x%X, 0x%X, 0x%X	General; parameters depend on event. See device documentation for interpretation.
0x8004	Error	System	%s: Unsuccessful FwdOpen-Response received from %d.%d.%d.%d (%s) (Error: %u)	
0x8005	Error	System	%s: FwdClose-Request sent to %d.%d.%d.%d (%s)	
0x8006	Error	System	%s: Unsuccessful FwdClose-Response received from %d.%d.%d.%d (%s) (Error: %u)	
0x8007	Error	System	%s: Connection with %d.%d.%d.%d (%s) closed	
0x8100	Error	General	Status word set: 0x%X, %d	Error bit set in the status word
0x8101	Error	General	Operation mode incompatible to PDO interface: 0x%X, %d	Mode of operation incompatible with the PDO interface
0x8102	Error	General	Invalid combination of Inputs and Outputs PDOs	Invalid combination of input and output PDOs
0x8103	Error	General	No variable linkage	No variables linked
0x8104	Error	General	Terminal-Overtemperature	The internal temperature of the terminal exceeds the parameterized error threshold. Activation of the terminal is prevented
0x8105	Error	General	PD-Watchdog	Communication between the fieldbus and the output stage is secured by a Watchdog. The axis is stopped automatically if the fieldbus communication is interrupted. - The EtherCAT connection was interrupted during operation - The Master was switched to Config mode during operation
0x8135	Error	General	Cycle time has to be a multiple of 125 µs	The IO or NC cycle time divided by 125 µs does not produce a whole number
0x8136	Error	General	Configuration error: invalid sampling rate	Configuration error: Invalid sampling rate
0x8137	Error	General	Electronic type plate: CRC error	Content of the external name plate memory invalid.
0x8140	Error	General	Sync Error	Real-time violation
0x8141	Error	General	Sync%X Interrupt lost	Sync%X Interrupt lost
0x8142	Error	General	Sync Interrupt asynchronous	Sync Interrupt asynchronous
0x8143	Error	General	Jitter too big	Jitter limit violation
0x817F	Error	General	Error: 0x%X, 0x%X, 0x%X	
0x8200	Error	Communication	Write access error: %d, %d	Error while writing
0x8201	Error	Communication	No communication to field-side (Auxiliary voltage missing)	- There is no voltage applied to the power contacts - A firmware update has failed
0x8281	Error	Communication	Ownership failed: %X	
0x8282	Error	Communication	To many Keys founded	
0x8283	Error	Communication	Key Creation failed: %X	
0x8284	Error	Communication	Key loading failed	
0x8285	Error	Communication	Reading Public Key failed: %X	
0x8286	Error	Communication	Reading Public EK failed: %X	
0x8287	Error	Communication	Reading PCR Value failed: %X	

Text ID	Type	Place	Text Message	Additional comment
0x8288	Error	Communication	Reading Certificate EK failed: %X	
0x8289	Error	Communication	Challenge could not be hashed: %X	
0x828A	Error	Communication	Tickstamp Process failed	
0x828B	Error	Communication	PCR Process failed: %X	
0x828C	Error	Communication	Quote Process failed: %X	
0x82FF	Error	Communication	Bootmode not activated	Boot mode not activated
0x8300	Error	Encoder	Set position error: 0x%X, %d	Error while setting the position
0x8301	Error	Encoder	Encoder increments not configured: 0x%X, %d	Encoder increments not configured
0x8302	Error	Encoder	Encoder error	The amplitude of the resolver is too small
0x8303	Error	Encoder	Encoder supply error	Encoder power supply unit error
0x8304	Error	Encoder	Encoder communication error, channel: %X	Encoder communication error
0x8305	Error	Encoder	EnDat2.2 is not supported, channel: %X	EnDat2.2 is not supported
0x8306	Error	Encoder	Delay time, tolerance limit exceeded, 0x%X, channel: %X	Runtime measurement, tolerance exceeded
0x8307	Error	Encoder	Delay time, maximum value exceeded, 0x%X, channel: %X	Runtime measurement, maximum value exceeded
0x8308	Error	Encoder	Unsupported ordering designation, 0x%X, channel: %X (only 02 and 22 is supported)	Wrong EnDat order ID
0x8309	Error	Encoder	Encoder CRC error, channel: %X	Encoder CRC error
0x830A	Error	Encoder	Temperature %X could not be read, channel: %X	Temperature cannot be read
0x8400	Error	Drive	Incorrect drive configuration: 0x%X, %d	Drive incorrectly configured
0x8401	Error	Drive	Limiting of calibration velocity: %d, %d	Limitation of the calibration velocity
0x8402	Error	Drive	Emergency stop activated: 0x%X, %d	Emergency stop activated
0x8403	Error	Drive	ADC Error	Error during current measurement in the ADC
0x8404	Error	Drive	Overcurrent	Overcurrent in phase U, V or W
0x8405	Error	Drive	Invalid modulo position: %d	Modulo position invalid
0x8406	Error	Drive	DC-Link undervoltage (Error)	The DC link voltage of the terminal is lower than the parameterized minimum voltage. Activation of the output stage is prevented
0x8407	Error	Drive	DC-Link overvoltage (Error)	The DC link voltage of the terminal is higher than the parameterized maximum voltage. Activation of the output stage is prevented
0x8408	Error	Drive	I2T-Model Amplifier overload (Error)	- The amplifier is being operated outside the specification - The I2T-model of the amplifier is incorrectly parameterized
0x8409	Error	Drive	I2T-Model motor overload (Error)	- The motor is being operated outside the parameterized rated values - The I2T-model of the motor is incorrectly parameterized
0x840A	Error	Drive	Overall current threshold exceeded	Total current exceeded
0x8415	Error	Drive	Invalid modulo factor: %d	Modulo factor invalid
0x8416	Error	Drive	Motor overtemperature	The internal temperature of the motor exceeds the parameterized error threshold. The motor stops immediately. Activation of the output stage is prevented.
0x8417	Error	Drive	Maximum rotating field velocity exceeded	Rotary field speed exceeds the value specified for dual use (EU 1382/2014).

Text ID	Type	Place	Text Message	Additional comment
0x841C	Error	Drive	STO while the axis was enabled	An attempt was made to activate the axis, despite the fact that no voltage is present at the STO input.
0x8550	Error	Inputs	Zero crossing phase %X missing	Zero crossing phase %X missing
0x8551	Error	Inputs	Phase sequence Error	Wrong direction of rotation
0x8552	Error	Inputs	Overcurrent phase %X	Overcurrent phase %X
0x8553	Error	Inputs	Overcurrent neutral wire	Overcurrent neutral wire
0x8581	Error	Inputs	Wire broken Ch %D	Wire broken Ch %d
0x8600	Error	General IO	Wrong supply voltage range	Supply voltage not in the correct range
0x8601	Error	General IO	Supply voltage to low	Supply voltage too low
0x8602	Error	General IO	Supply voltage to high	Supply voltage too high
0x8603	Error	General IO	Over current of supply voltage	Overcurrent of supply voltage
0x8610	Error	General IO	Wrong output voltage range	Output voltage not in the correct range
0x8611	Error	General IO	Output voltage to low	Output voltage too low
0x8612	Error	General IO	Output voltage to high	Output voltage too high
0x8613	Error	General IO	Over current of output voltage	Overcurrent of output voltage
0x8700	Error		Channel/Interface not calibrated	Channel/interface not synchronized
0x8701	Error		Operating time was manipulated	Operating time was manipulated
0x8702	Error		Oversampling setting is not possible	Oversampling setting not possible
0x8703	Error		No slave controller found	No slave controller found
0x8704	Error		Slave controller is not in Bootstrap	Slave controller is not in bootstrap
0x8705	Error		Processor usage to high (>= 100%%)	Processor load too high (>= 100%%)
0x8706	Error		Channel in saturation	Channel in saturation
0x8707	Error		Channel overload	Channel overload
0x8708	Error		Overloadtime was manipulated	Overload time was manipulated
0x8709	Error		Saturationtime was manipulated	Saturation time was manipulated
0x870A	Error		Channel range error	Measuring range error for the channel
0x870B	Error		no ADC clock	No ADC clock available
0xFFFF	Information		Debug: 0x%X, 0x%X, 0x%X	Debug: 0x%X, 0x%X, 0x%X

7 Appendix

7.1 EtherCAT AL Status Codes

For detailed information please refer to the [EtherCAT system description](#).

7.2 Firmware compatibility

Beckhoff EtherCAT devices are delivered with the latest available firmware version. Compatibility of firmware and hardware is mandatory; not every combination ensures compatibility. The overview below shows the hardware versions on which a firmware can be operated.

Note

- It is recommended to use the newest possible firmware for the respective hardware.
- Beckhoff is not under any obligation to provide customers with free firmware updates for delivered products.

NOTE			
Risk of damage to the device!			
Pay attention to the instructions for firmware updates on the separate page [▶ 184] . If a device is placed in BOOTSTRAP mode for a firmware update, it does not check when downloading whether the new firmware is suitable. This can result in damage to the device! Therefore, always make sure that the firmware is suitable for the hardware version!			

EL3413-0000			
Hardware (HW)	Firmware (FW)	Revision no.	Date of release
03 - 10	02	EL3413-0000-0016	2012/06
		EL3413-0000-0017	2012/07
	03		2014/08
	04	EL3413-0000-0018	2014/09
	05		2014/12
	06		2015/02
10 - 11	07		2015/03
04 - 11*	08		2016/08
		EL3413-0000-0019	2016/09
01 - 12*	10*	EL3413-0000-0020	2017/12

EL3413-0001			
Hardware (HW)	Firmware (FW)	Revision no.	Date of release
00 - 02	01	EL3413-0001-0016	2013/10
03 - 05*	02	EL3413-0001-0017	2014/04
	03		2015/06
	10*	EL3413-0001-0018	2017/12

EL3413-0120			
Hardware (HW)	Firmware (FW)	Revision no.	Date of release
04 - 11*	01	EL3413-0120-0016	2012/07
		EL3413-0120-0017	2012/08
	02		2014/06
	03		2016/03
	04	EL3413-0120-0018	2016/03
	10*	EL3413-0120-0019	2017/12

EL3433-0000			
Hardware (HW)	Firmware (FW)	Revision no.	Date of release
00 - 02	00	EL3433-0000-0016	2012/11
	01		2014/03
		EL3433-0000-0017	2016/12
01 - 03*	10*	EL3433-0000-0018	2017/12

*) This is the current compatible firmware/hardware version at the time of the preparing this documentation. Check on the Beckhoff web page whether more up-to-date [documentation](#) is available.

7.3 Firmware Update EL/ES/EM/ELM/EPxxxx

This section describes the device update for Beckhoff EtherCAT slaves from the EL/ES, ELM, EM, EK and EP series. A firmware update should only be carried out after consultation with Beckhoff support.

Storage locations

An EtherCAT slave stores operating data in up to 3 locations:

- Depending on functionality and performance EtherCAT slaves have one or several local controllers for processing I/O data. The corresponding program is the so-called **firmware** in *.efw format.
- In some EtherCAT slaves the EtherCAT communication may also be integrated in these controllers. In this case the controller is usually a so-called **FPGA** chip with *.rbf firmware.
- In addition, each EtherCAT slave has a memory chip, a so-called **ESI-EEPROM**, for storing its own device description (ESI: EtherCAT Slave Information). On power-up this description is loaded and the EtherCAT communication is set up accordingly. The device description is available from the download area of the Beckhoff website at (<https://www.beckhoff.de>). All ESI files are accessible there as zip files.

Customers can access the data via the EtherCAT fieldbus and its communication mechanisms. Acyclic mailbox communication or register access to the ESC is used for updating or reading of these data.

The TwinCAT System Manager offers mechanisms for programming all 3 parts with new data, if the slave is set up for this purpose. Generally the slave does not check whether the new data are suitable, i.e. it may no longer be able to operate if the data are unsuitable.

Simplified update by bundle firmware

The update using so-called **bundle firmware** is more convenient: in this case the controller firmware and the ESI description are combined in a *.efw file; during the update both the firmware and the ESI are changed in the terminal. For this to happen it is necessary

- for the firmware to be in a packed format: recognizable by the file name, which also contains the revision number, e.g. ELxxxx-xxxx_REV0016_SW01.efw
- for password=1 to be entered in the download dialog. If password=0 (default setting) only the firmware update is carried out, without an ESI update.
- for the device to support this function. The function usually cannot be retrofitted; it is a component of many new developments from year of manufacture 2016.

Following the update, its success should be verified

- ESI/Revision: e.g. by means of an online scan in TwinCAT ConfigMode/FreeRun – this is a convenient way to determine the revision
- Firmware: e.g. by looking in the online CoE of the device

NOTE

Risk of damage to the device!

Note the following when downloading new device files

- Firmware downloads to an EtherCAT device must not be interrupted
- Flawless EtherCAT communication must be ensured. CRC errors or LostFrames must be avoided.
- The power supply must adequately dimensioned. The signal level must meet the specification.

In the event of malfunctions during the update process the EtherCAT device may become unusable and require re-commissioning by the manufacturer.

7.3.1 Device description ESI file/XML

NOTE

Attention regarding update of the ESI description/EEPROM

Some slaves have stored calibration and configuration data from the production in the EEPROM. These are irretrievably overwritten during an update.

The ESI device description is stored locally on the slave and loaded on start-up. Each device description has a unique identifier consisting of slave name (9 characters/digits) and a revision number (4 digits). Each slave configured in the System Manager shows its identifier in the EtherCAT tab:

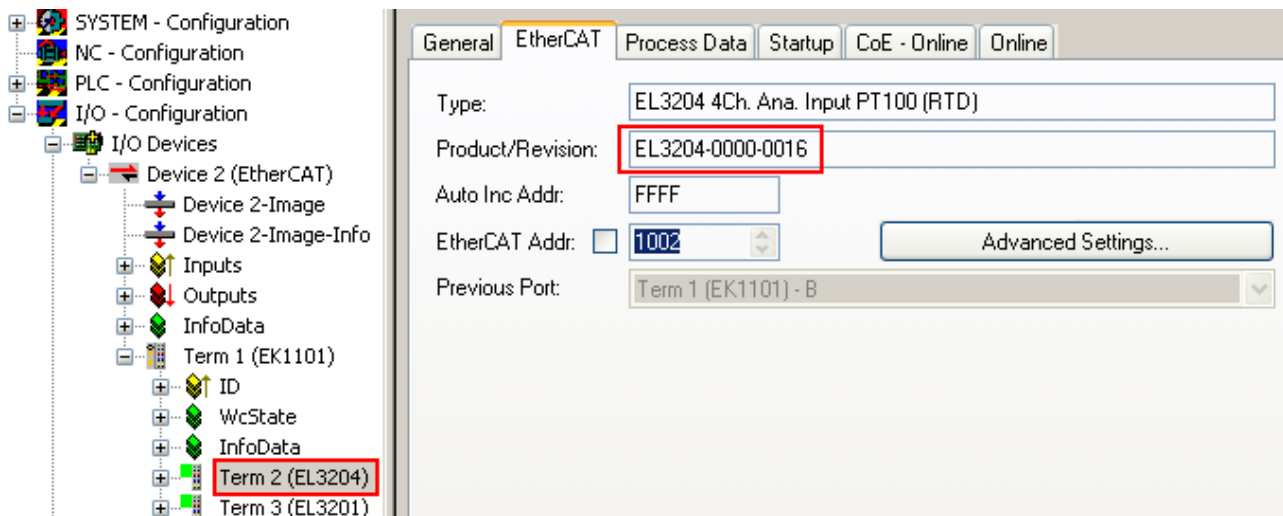

Fig. 164: Device identifier consisting of name EL3204-0000 and revision -0016

The configured identifier must be compatible with the actual device description used as hardware, i.e. the description which the slave has loaded on start-up (in this case EL3204). Normally the configured revision must be the same or lower than that actually present in the terminal network.

For further information on this, please refer to the [EtherCAT system documentation](#).

● Update of XML/ESI description

i The device revision is closely linked to the firmware and hardware used. Incompatible combinations lead to malfunctions or even final shutdown of the device. Corresponding updates should only be carried out in consultation with Beckhoff support.

Display of ESI slave identifier

The simplest way to ascertain compliance of configured and actual device description is to scan the EtherCAT boxes in TwinCAT mode Config/FreeRun:

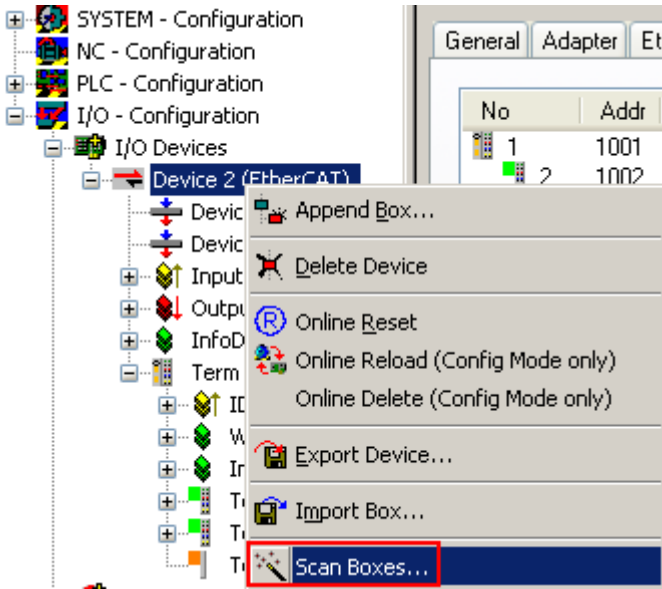

Fig. 165: Scan the subordinate field by right-clicking on the EtherCAT device

If the found field matches the configured field, the display shows



Fig. 166: Configuration is identical

otherwise a change dialog appears for entering the actual data in the configuration.

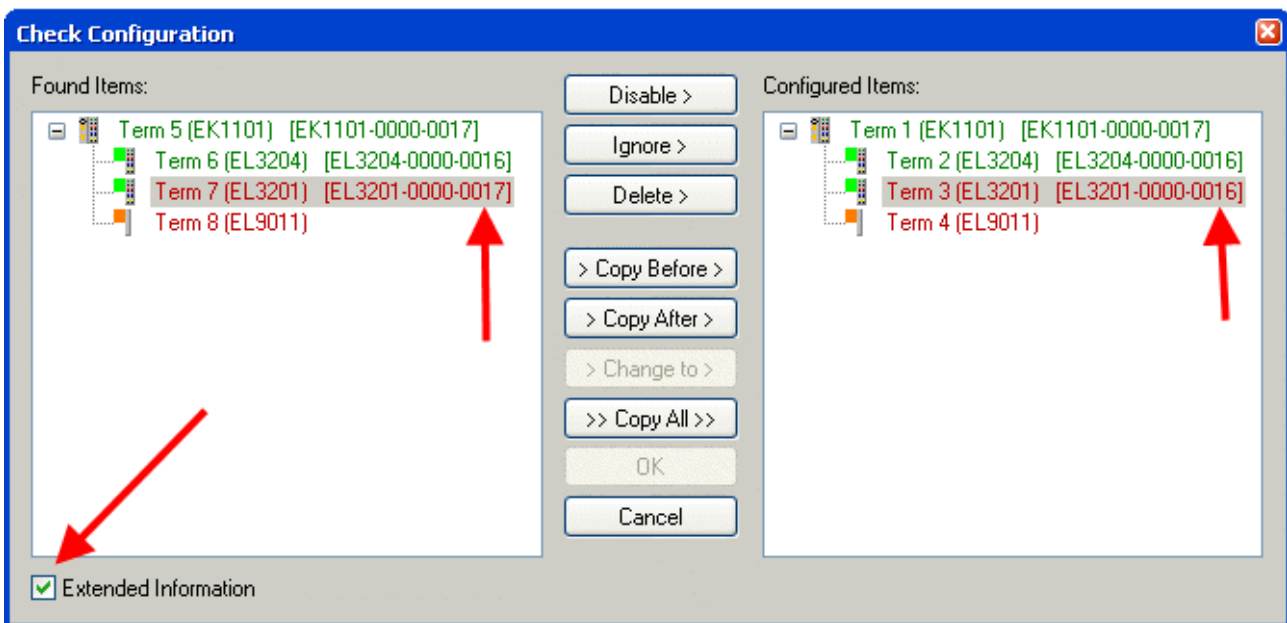

Fig. 167: Change dialog

In this example in Fig. *Change dialog*, an EL3201-0000-0017 was found, while an EL3201-0000-0016 was configured. In this case the configuration can be adapted with the *Copy Before* button. The *Extended Information* checkbox must be set in order to display the revision.

Changing the ESI slave identifier

The ESI/EEPROM identifier can be updated as follows under TwinCAT:

- Trouble-free EtherCAT communication must be established with the slave.
- The state of the slave is irrelevant.
- Right-clicking on the slave in the online display opens the *EEPROM Update* dialog, Fig. *EEPROM Update*

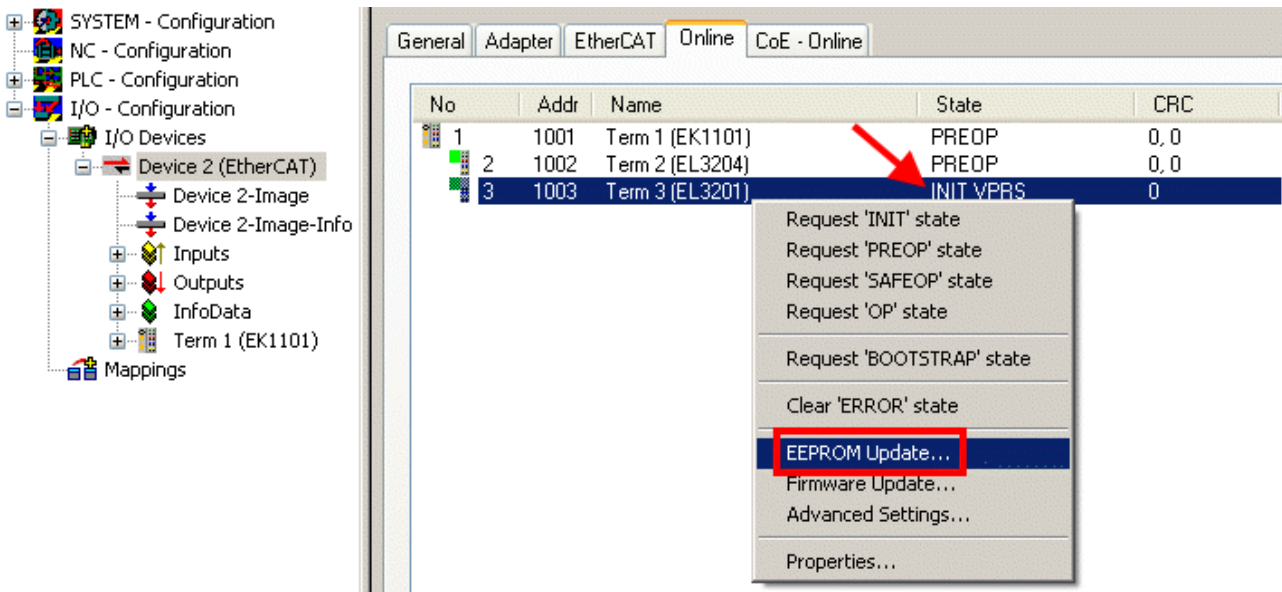

Fig. 168: EEPROM Update

The new ESI description is selected in the following dialog, see Fig. *Selecting the new ESI*. The checkbox *Show Hidden Devices* also displays older, normally hidden versions of a slave.

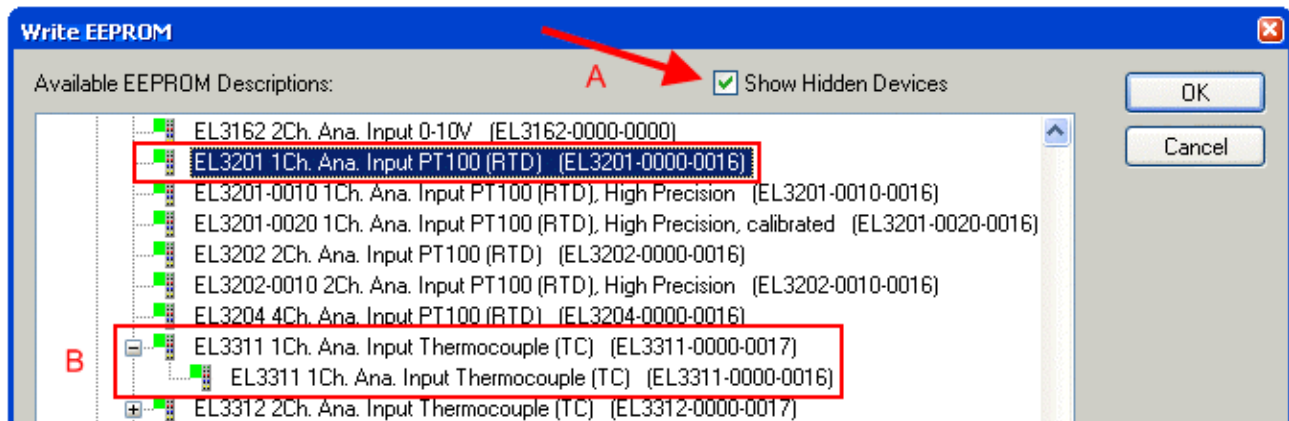

Fig. 169: Selecting the new ESI

A progress bar in the System Manager shows the progress. Data are first written, then verified.

i The change only takes effect after a restart.

Most EtherCAT devices read a modified ESI description immediately or after startup from the INIT. Some communication settings such as distributed clocks are only read during power-on. The EtherCAT slave therefore has to be switched off briefly in order for the change to take effect.

7.3.2 Firmware explanation

Determining the firmware version

Determining the version on laser inscription

Beckhoff EtherCAT slaves feature serial numbers applied by laser. The serial number has the following structure: **KK YY FF HH**

KK - week of production (CW, calendar week)
 YY - year of production
 FF - firmware version
 HH - hardware version

Example with ser. no.: 12 10 03 02:

12 - week of production 12
 10 - year of production 2010
 03 - firmware version 03
 02 - hardware version 02

Determining the version via the System Manager

The TwinCAT System Manager shows the version of the controller firmware if the master can access the slave online. Click on the E-Bus Terminal whose controller firmware you want to check (in the example terminal 2 (EL3204)) and select the tab *CoE Online* (CAN over EtherCAT).

● CoE Online and Offline CoE

i Two CoE directories are available:

- **online**: This is offered in the EtherCAT slave by the controller, if the EtherCAT slave supports this. This CoE directory can only be displayed if a slave is connected and operational.
- **offline**: The EtherCAT Slave Information ESI/XML may contain the default content of the CoE. This CoE directory can only be displayed if it is included in the ESI (e.g. "Beckhoff EL5xxx.xml").

The Advanced button must be used for switching between the two views.

In Fig. *Display of EL3204 firmware version* the firmware version of the selected EL3204 is shown as 03 in CoE entry 0x100A.

The screenshot displays the TwinCAT System Manager interface. On the left, a tree view shows the configuration for 'Device 2 (EtherCAT)', with 'Term 2 (EL3204)' selected. The main window shows the 'CoE - Online' tab. The 'Advanced Settings' dialog is open, with the 'Online Data' button highlighted. The 'Dictionary' tab is selected, showing the 'Software version' entry (100A) with a value of 03. The 'Advanced Settings' dialog also shows the 'Online' radio button selected.

Index	Name	Flags	Value
1000	Device type	RO	0x01401389 (20976521)
1008	Device name	RO	EL3204-0000
1009	Hardware version	RO	00
100A	Software version	RO	03
1011:0	Restore default parameters	RU	> 1 <

Fig. 170: Display of EL3204 firmware version

In (A) TwinCAT 2.11 shows that the Online CoE directory is currently displayed. If this is not the case, the Online directory can be loaded via the *Online* option in Advanced Settings (B) and double-clicking on *AllObjects*.

7.3.3 Updating controller firmware *.efw

i **CoE directory**

The Online CoE directory is managed by the controller and stored in a dedicated EEPROM, which is generally not changed during a firmware update.

Switch to the *Online* tab to update the controller firmware of a slave, see Fig. *Firmware Update*.

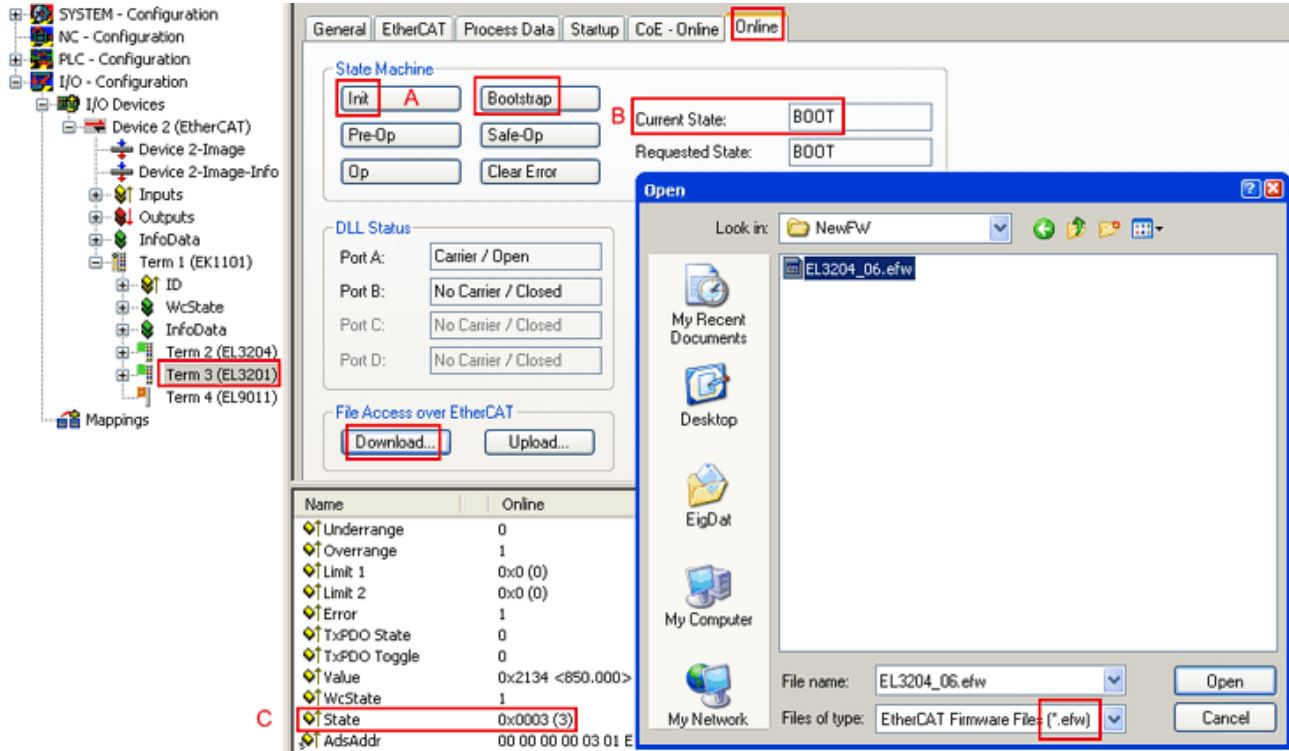
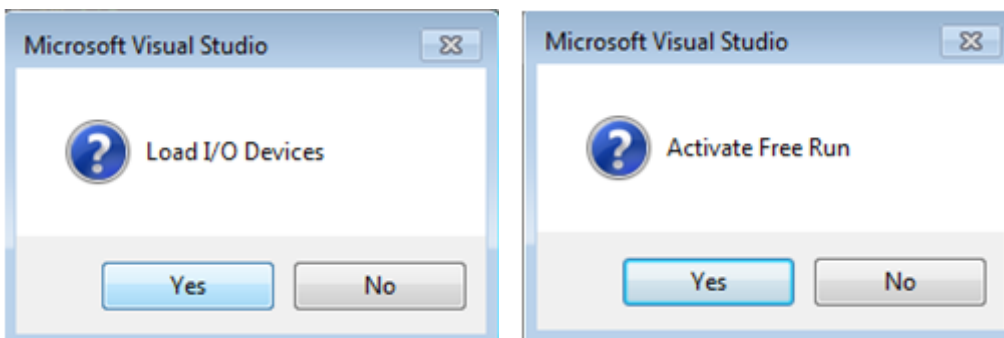

Fig. 171: Firmware Update

Proceed as follows, unless instructed otherwise by Beckhoff support. Valid for TwinCAT 2 and 3 as EtherCAT master.

- Switch TwinCAT system to ConfigMode/FreeRun with cycle time ≥ 1 ms (default in ConfigMode is 4 ms). A FW-Update during real time operation is not recommended.



- Switch EtherCAT Master to PreOP

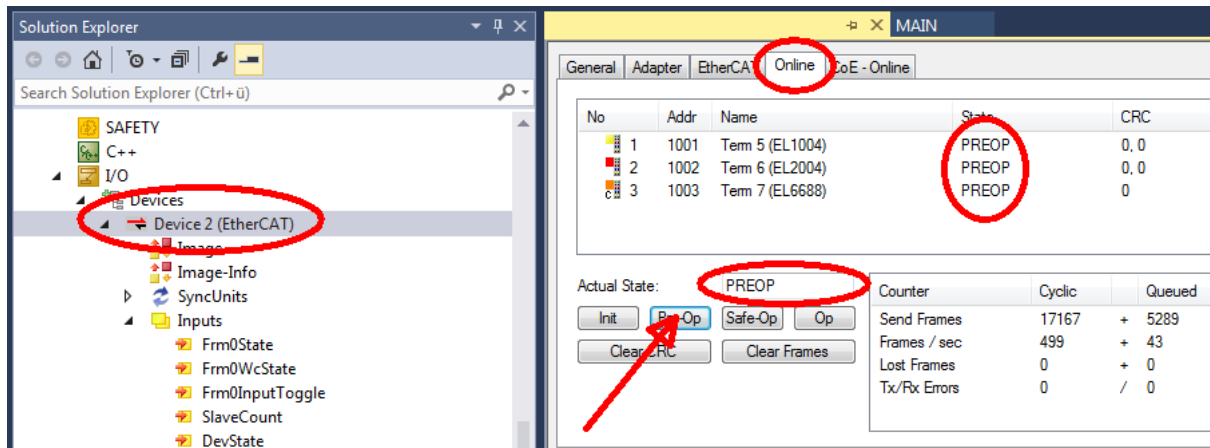

- Switch slave to INIT (A)
- Switch slave to BOOTSTRAP
- Check the current status (B, C)
- Download the new *.efw file (wait until it ends). A pass word will not be necessary usually.

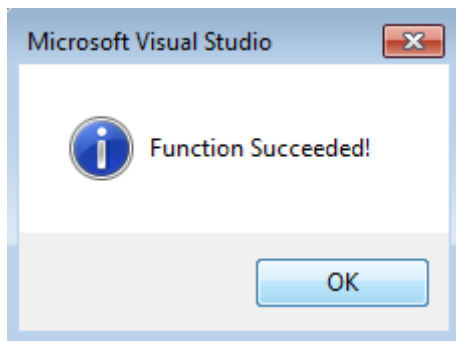

- After the download switch to INIT, then PreOP
- Switch off the slave briefly (don't pull under voltage!)
- Check within CoE 0x100A, if the FW status was correctly overtaken.

7.3.4 FPGA firmware *.rbf

If an FPGA chip deals with the EtherCAT communication an update may be accomplished via an *.rbf file.

- Controller firmware for processing I/O signals
- FPGA firmware for EtherCAT communication (only for terminals with FPGA)

The firmware version number included in the terminal serial number contains both firmware components. If one of these firmware components is modified this version number is updated.

Determining the version via the System Manager

The TwinCAT System Manager indicates the FPGA firmware version. Click on the Ethernet card of your EtherCAT strand (Device 2 in the example) and select the *Online* tab.

The *Reg:0002* column indicates the firmware version of the individual EtherCAT devices in hexadecimal and decimal representation.

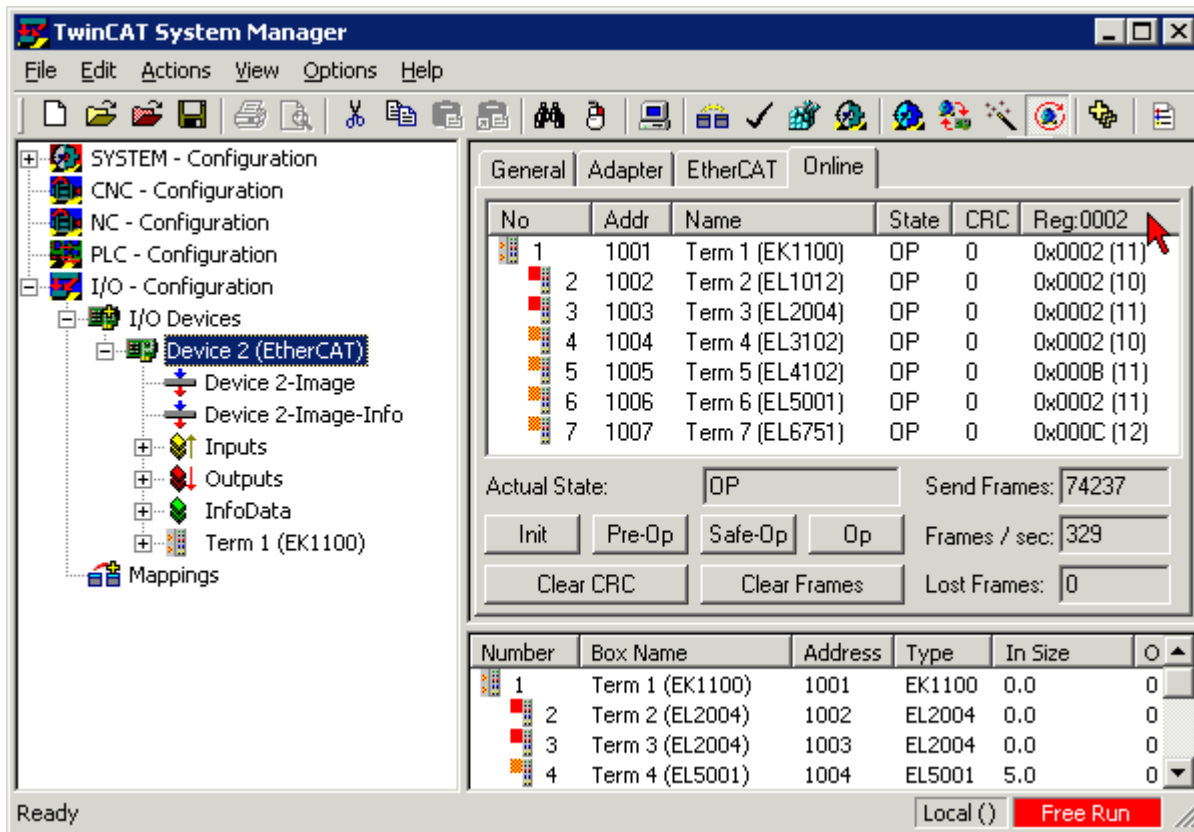

Fig. 172: FPGA firmware version definition

If the column *Reg:0002* is not displayed, right-click the table header and select *Properties* in the context menu.

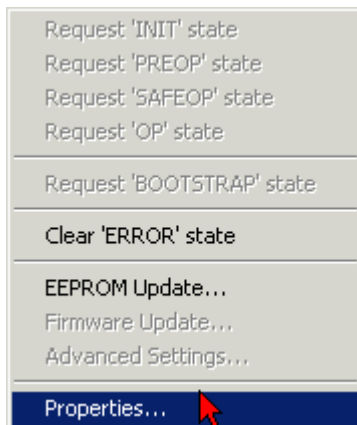

Fig. 173: Context menu *Properties*

The *Advanced Settings* dialog appears where the columns to be displayed can be selected. Under *Diagnosis/Online View* select the *'0002 ETxxxx Build'* check box in order to activate the FPGA firmware version display.

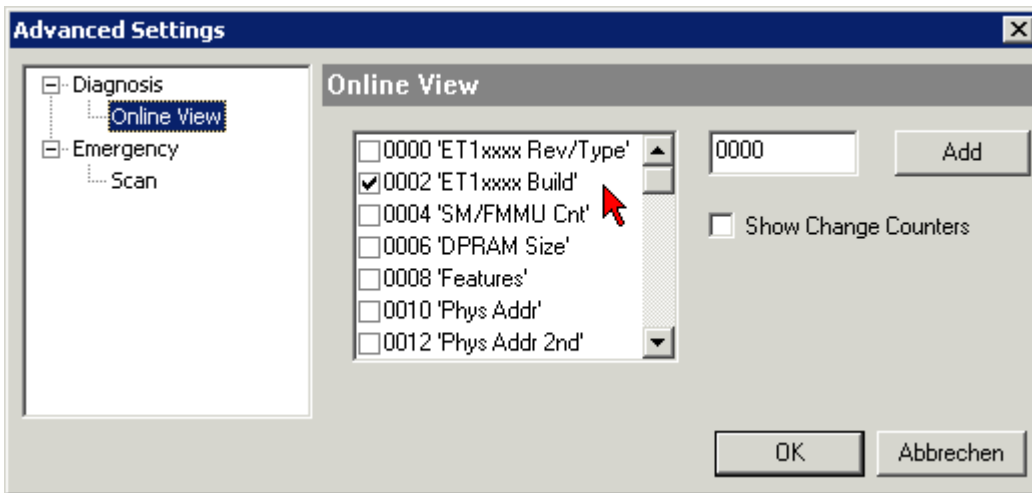

Fig. 174: Dialog *Advanced Settings*

Update

For updating the FPGA firmware

- of an EtherCAT coupler the coupler must have FPGA firmware version 11 or higher;
- of an E-Bus Terminal the terminal must have FPGA firmware version 10 or higher.

Older firmware versions can only be updated by the manufacturer!

Updating an EtherCAT device

The following sequence order have to be met if no other specifications are given (e.g. by the Beckhoff support):

- Switch TwinCAT system to ConfigMode/FreeRun with cycle time ≥ 1 ms (default in ConfigMode is 4 ms). A FW-Update during real time operation is not recommended.

- In the TwinCAT System Manager select the terminal for which the FPGA firmware is to be updated (in the example: Terminal 5: EL5001) and click the *Advanced Settings* button in the *EtherCAT* tab:

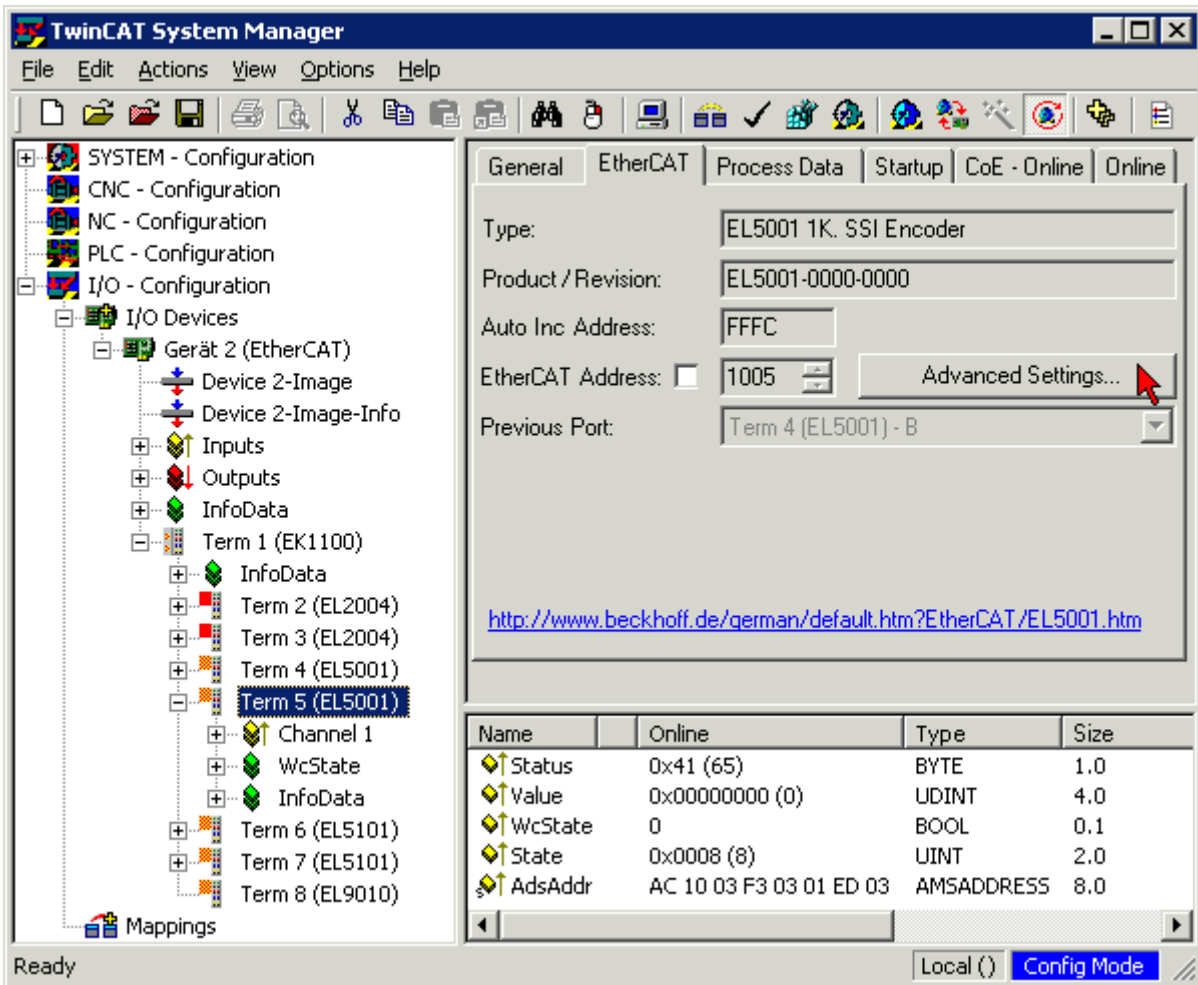

- The *Advanced Settings* dialog appears. Under *ESC Access/E²PROM/FPGA* click on *Write FPGA* button:

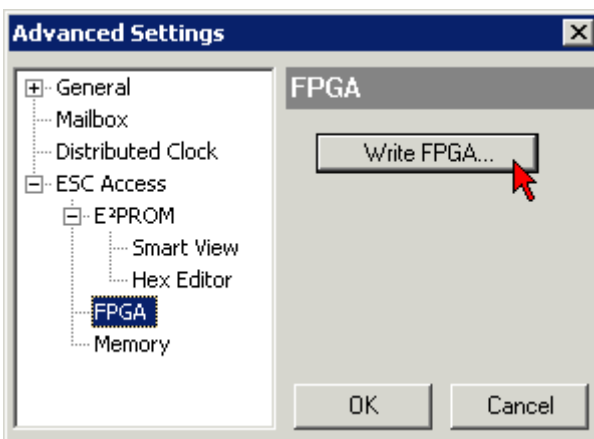

- Select the file (*.rbf) with the new FPGA firmware, and transfer it to the EtherCAT device:

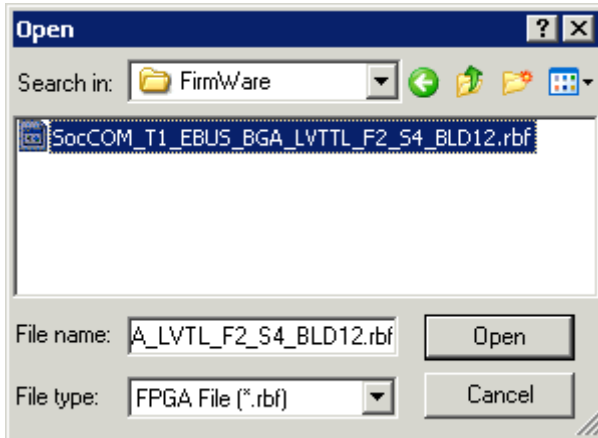

- Wait until download ends
- Switch slave current less for a short time (don't pull under voltage!). In order to activate the new FPGA firmware a restart (switching the power supply off and on again) of the EtherCAT device is required.
- Check the new FPGA status

NOTE

Risk of damage to the device!

A download of firmware to an EtherCAT device must not be interrupted in any case! If you interrupt this process by switching off power supply or disconnecting the Ethernet link, the EtherCAT device can only be recommissioned by the manufacturer!

7.3.5 Simultaneous updating of several EtherCAT devices

The firmware and ESI descriptions of several devices can be updated simultaneously, provided the devices have the same firmware file/ESI.

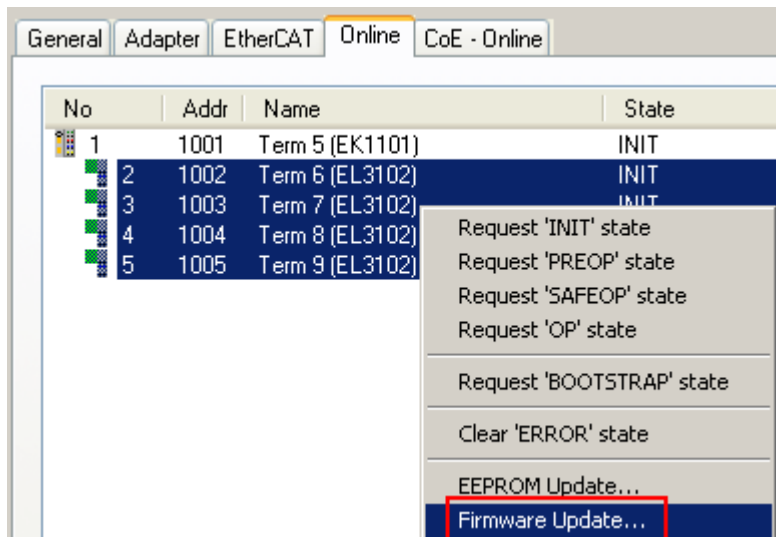

Fig. 175: Multiple selection and firmware update

Select the required slaves and carry out the firmware update in BOOTSTRAP mode as described above.

7.4 Restoring the delivery state

To restore the delivery state for backup objects in ELxxx terminals, the CoE object Restore default parameters, *SubIndex 001* can be selected in the TwinCAT System Manager (Config mode) (see Fig. *Selecting the Restore default parameters PDO*)

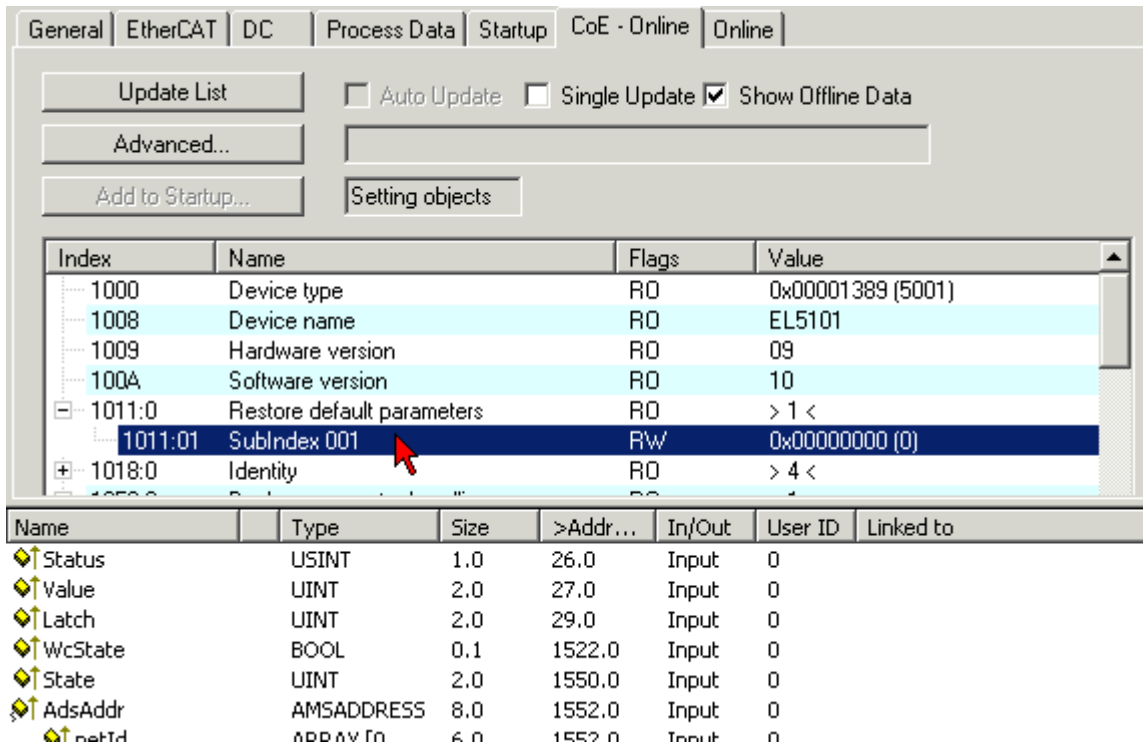

Fig. 176: Selecting the "Restore default parameters" PDO

Double-click on SubIndex 001 to enter the Set Value dialog. Enter the value **1684107116** in field *Dec* or the value **0x64616F6C** in field *Hex* and confirm with *OK* (Fig. *Entering a restore value in the Set Value dialog*). All backup objects are reset to the delivery state.

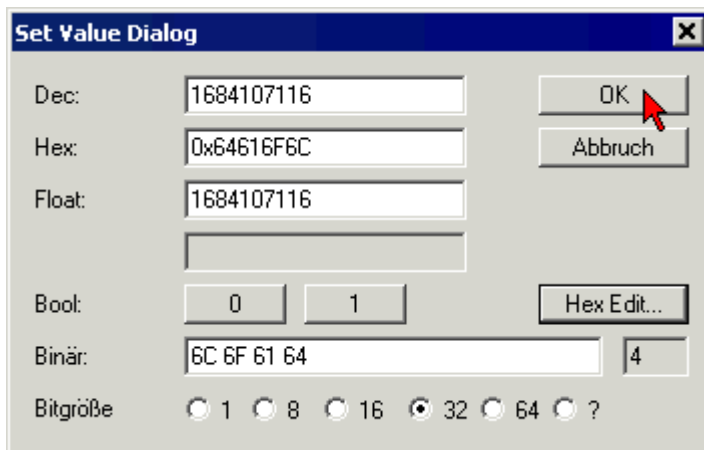

Fig. 177: Entering a restore value in the Set Value dialog

Alternative restore value

In some older terminals the backup objects can be switched with an alternative restore value: Decimal value: 1819238756, Hexadecimal value: 0x6C6F6164An incorrect entry for the restore value has no effect.

7.5 Support and Service

Beckhoff and their partners around the world offer comprehensive support and service, making available fast and competent assistance with all questions related to Beckhoff products and system solutions.

Beckhoff's branch offices and representatives

Please contact your Beckhoff branch office or representative for local support and service on Beckhoff products!

The addresses of Beckhoff's branch offices and representatives round the world can be found on her internet pages:

<http://www.beckhoff.com>

You will also find further documentation for Beckhoff components there.

Beckhoff Headquarters

Beckhoff Automation GmbH & Co. KG

Huelshorstweg 20
33415 Verl
Germany

Phone: +49(0)5246/963-0
Fax: +49(0)5246/963-198
e-mail: info@beckhoff.com

Beckhoff Support

Support offers you comprehensive technical assistance, helping you not only with the application of individual Beckhoff products, but also with other, wide-ranging services:

- support
- design, programming and commissioning of complex automation systems
- and extensive training program for Beckhoff system components

Hotline: +49(0)5246/963-157
Fax: +49(0)5246/963-9157
e-mail: support@beckhoff.com

Beckhoff Service

The Beckhoff Service Center supports you in all matters of after-sales service:

- on-site service
- repair service
- spare parts service
- hotline service

Hotline: +49(0)5246/963-460
Fax: +49(0)5246/963-479
e-mail: service@beckhoff.com

List of illustrations

Fig. 1	EL5021 EL terminal, standard IP20 IO device with serial/ batch number and revision ID (since 2014/01).....	13
Fig. 2	EK1100 EtherCAT coupler, standard IP20 IO device with serial/ batch number.....	13
Fig. 3	CU2016 switch with serial/ batch number.....	13
Fig. 4	EL3202-0020 with serial/ batch number 26131006 and unique ID-number 204418	14
Fig. 5	EP1258-00001 IP67 EtherCAT Box with batch number/ date code 22090101 and unique serial number 158102.....	14
Fig. 6	EP1908-0002 IP67 EtherCAT Safety Box with batch number/ date code 071201FF and unique serial number 00346070	14
Fig. 7	EL2904 IP20 safety terminal with batch number/ date code 50110302 and unique serial number 00331701.....	14
Fig. 8	ELM3604-0002 terminal with unique ID number (QR code) 100001051 and serial/ batch number 44160201.....	15
Fig. 9	EL3413	16
Fig. 10	EL3413-0001	16
Fig. 11	EL3413-0120	17
Fig. 12	EL3433	19
Fig. 13	Voltage u and current i curves	21
Fig. 14	Power s(t) curve.....	22
Fig. 15	u(t), i(t), p(t) curves with phase shift angle φ	23
Fig. 16	Four-quadrant representation of active/reactive power in motor and generator mode.....	24
Fig. 17	System manager current calculation	28
Fig. 18	EtherCAT tab -> Advanced Settings -> Behavior -> Watchdog	29
Fig. 19	States of the EtherCAT State Machine.....	31
Fig. 20	"CoE Online " tab	33
Fig. 21	Startup list in the TwinCAT System Manager	34
Fig. 22	Offline list.....	35
Fig. 23	Online list	35
Fig. 24	Spring contacts of the Beckhoff I/O components.....	38
Fig. 25	Attaching on mounting rail	39
Fig. 26	Disassembling of terminal.....	40
Fig. 27	Power contact on left side.....	41
Fig. 28	Standard wiring.....	42
Fig. 29	Pluggable wiring	42
Fig. 30	High Density Terminals.....	42
Fig. 31	Connecting a cable on a terminal point	44
Fig. 32	Recommended distances for standard installation position	46
Fig. 33	Other installation positions	47
Fig. 34	Correct positioning.....	48
Fig. 35	Incorrect positioning.....	48
Fig. 36	EL3413-0000 LEDs	50
Fig. 37	EL3413-0000 Connection.....	51
Fig. 38	EL3413-0001 LEDs	53
Fig. 39	EL3413-0001 Connection.....	54
Fig. 40	EL3413-0120 LEDs	56
Fig. 41	EL3413-0120 Connection.....	57

Fig. 42	EL3433-0000 LEDs	59
Fig. 43	EL3433-0000 Connection	60
Fig. 44	Relationship between user side (commissioning) and installation.....	63
Fig. 45	Control configuration with Embedded PC, input (EL1004) and output (EL2008)	64
Fig. 46	Initial TwinCAT 2 user interface.....	65
Fig. 47	Selection of the target system	66
Fig. 48	Specify the PLC for access by the TwinCAT System Manager: selection of the target system ..	66
Fig. 49	Select "Scan Devices..."	67
Fig. 50	Automatic detection of I/O devices: selection the devices to be integrated.....	67
Fig. 51	Mapping of the configuration in the TwinCAT 2 System Manager.....	68
Fig. 52	Reading of individual terminals connected to a device.....	68
Fig. 53	TwinCAT PLC Control after startup	69
Fig. 54	Sample program with variables after a compile process (without variable integration).....	70
Fig. 55	Appending the TwinCAT PLC Control project	70
Fig. 56	PLC project integrated in the PLC configuration of the System Manager	71
Fig. 57	Creating the links between PLC variables and process objects	71
Fig. 58	Selecting PDO of type BOOL	72
Fig. 59	Selecting several PDOs simultaneously: activate "Continuous" and "All types".....	72
Fig. 60	Application of a "Goto Link" variable, using "MAIN.bEL1004_Ch4" as a sample	73
Fig. 61	Choose target system (remote)	74
Fig. 62	PLC Control logged in, ready for program startup	75
Fig. 63	Initial TwinCAT 3 user interface.....	76
Fig. 64	Create new TwinCAT project.....	76
Fig. 65	New TwinCAT3 project in the project folder explorer	77
Fig. 66	Selection dialog: Choose the target system	77
Fig. 67	Specify the PLC for access by the TwinCAT System Manager: selection of the target system ..	78
Fig. 68	Select "Scan"	78
Fig. 69	Automatic detection of I/O devices: selection the devices to be integrated.....	79
Fig. 70	Mapping of the configuration in VS shell of the TwinCAT3 environment.....	79
Fig. 71	Reading of individual terminals connected to a device.....	80
Fig. 72	Adding the programming environment in "PLC"	81
Fig. 73	Specifying the name and directory for the PLC programming environment	81
Fig. 74	Initial "Main" program of the standard PLC project.....	82
Fig. 75	Sample program with variables after a compile process (without variable integration).....	83
Fig. 76	Start program compilation.....	83
Fig. 77	Creating the links between PLC variables and process objects	84
Fig. 78	Selecting PDO of type BOOL	84
Fig. 79	Selecting several PDOs simultaneously: activate "Continuous" and "All types".....	85
Fig. 80	Application of a "Goto Link" variable, using "MAIN.bEL1004_Ch4" as a sample	85
Fig. 81	TwinCAT development environment (VS shell): logged-in, after program startup.....	86
Fig. 82	System Manager "Options" (TwinCAT 2).....	88
Fig. 83	Call up under VS Shell (TwinCAT 3)	88
Fig. 84	Overview of network interfaces	88
Fig. 85	EtherCAT device properties(TwinCAT 2): click on „Compatible Devices...“ of tab “Adapter”	89
Fig. 86	Windows properties of the network interface.....	89
Fig. 87	Exemplary correct driver setting for the Ethernet port	90

Fig. 88	Incorrect driver settings for the Ethernet port	91
Fig. 89	TCP/IP setting for the Ethernet port	92
Fig. 90	Identifier structure	93
Fig. 91	OnlineDescription information window (TwinCAT 2)	94
Fig. 92	Information window OnlineDescription (TwinCAT 3)	94
Fig. 93	File OnlineDescription.xml created by the System Manager	95
Fig. 94	Indication of an online recorded ESI of EL2521 as an example	95
Fig. 95	Information window for faulty ESI file (left: TwinCAT 2; right: TwinCAT 3).....	95
Fig. 96	Using the ESI Updater (>= TwinCAT 2.11).....	97
Fig. 97	Using the ESI Updater (TwinCAT 3).....	97
Fig. 98	Append EtherCAT device (left: TwinCAT 2; right: TwinCAT 3)	98
Fig. 99	Selecting the EtherCAT connection (TwinCAT 2.11, TwinCAT 3).....	98
Fig. 100	Selecting the Ethernet port	98
Fig. 101	EtherCAT device properties (TwinCAT 2)	99
Fig. 102	Appending EtherCAT devices (left: TwinCAT 2; right: TwinCAT 3).....	99
Fig. 103	Selection dialog for new EtherCAT device	100
Fig. 104	Display of device revision	100
Fig. 105	Display of previous revisions	101
Fig. 106	Name/revision of the terminal	101
Fig. 107	EtherCAT terminal in the TwinCAT tree (left: TwinCAT 2; right: TwinCAT 3).....	102
Fig. 108	Differentiation local/target system (left: TwinCAT 2; right: TwinCAT 3).....	103
Fig. 109	Scan Devices (left: TwinCAT 2; right: TwinCAT 3).....	103
Fig. 110	Note for automatic device scan (left: TwinCAT 2; right: TwinCAT 3).....	103
Fig. 111	Detected Ethernet devices	104
Fig. 112	Example default state	104
Fig. 113	Installing EthetCAT terminal with revision -1018	105
Fig. 114	Detection of EtherCAT terminal with revision -1019.....	105
Fig. 115	Scan query after automatic creation of an EtherCAT device (left: TwinCAT 2; right: Twin- CAT 3)	105
Fig. 116	Manual triggering of a device scan on a specified EtherCAT device (left: TwinCAT 2; right: TwinCAT 3).....	106
Fig. 117	Scan progressexemplary by TwinCAT 2	106
Fig. 118	Config/FreeRun query (left: TwinCAT 2; right: TwinCAT 3).....	106
Fig. 119	Displaying of “Free Run” and “Config Mode” toggling right below in the status bar	106
Fig. 120	TwinCAT can also be switched to this state by using a button (left: TwinCAT 2; right: Twin- CAT 3)	106
Fig. 121	Online display example	107
Fig. 122	Faulty identification	107
Fig. 123	Identical configuration (left: TwinCAT 2; right: TwinCAT 3)	108
Fig. 124	Correction dialog	108
Fig. 125	Name/revision of the terminal	109
Fig. 126	Correction dialog with modifications	110
Fig. 127	Dialog “Change to Compatible Type...” (left: TwinCAT 2; right: TwinCAT 3).....	110
Fig. 128	TwinCAT 2 Dialog Change to Alternative Type	110
Fig. 129	Branch element as terminal EL3751.....	111
Fig. 130	“General” tab.....	111
Fig. 131	„EtherCAT“ tab.....	112

Fig. 132 "Process Data" tab	113
Fig. 133 Configuring the process data	114
Fig. 134 „Startup“ tab	115
Fig. 135 "CoE – Online" tab	116
Fig. 136 Dialog "Advanced settings"	117
Fig. 137 „Online“ tab	117
Fig. 138 "DC" tab (Distributed Clocks).....	118
Fig. 139 Selection of the diagnostic information of an EtherCAT Slave	120
Fig. 140 Basic EtherCAT Slave Diagnosis in the PLC.....	121
Fig. 141 EL3102, CoE directory	123
Fig. 142 Example of commissioning aid for a EL3204	124
Fig. 143 Default behaviour of the System Manager	125
Fig. 144 Default target state in the Slave	125
Fig. 145 PLC function blocks	126
Fig. 146 Illegally exceeding the E-Bus current	127
Fig. 147 Warning message for exceeding E-Bus current	127
Fig. 148 Process Data tab SM2, EL34x3.....	128
Fig. 149 Process Data tab SM3, EL34x3.....	129
Fig. 150 Selection of predefined PDOs	133
Fig. 151 Writing Subindex 01, Object FB00.....	135
Fig. 152 Full scale value, measuring span	141
Fig. 153 SE and DIFF module as 2-channel version	143
Fig. 154 2-wire connection.....	145
Fig. 155 Connection of externally supplied sensors	146
Fig. 156 2-, 3- and 4-wire connection at single-ended and differential inputs	147
Fig. 157 Common-mode voltage (V _{cm}).....	148
Fig. 158 Recommended operating voltage range.....	149
Fig. 159 Signal processing analog input.....	149
Fig. 160 Diagram signal delay (step response)	151
Fig. 161 Diagram signal delay (linear)	151
Fig. 162 DiagMessages in the CoE	173
Fig. 163 Implementation of the DiagMessage system in the TwinCAT System Manager	174
Fig. 164 Device identifier consisting of name EL3204-0000 and revision -0016	185
Fig. 165 Scan the subordinate field by right-clicking on the EtherCAT device	186
Fig. 166 Configuration is identical	186
Fig. 167 Change dialog	186
Fig. 168 EEPROM Update	187
Fig. 169 Selecting the new ESI.....	187
Fig. 170 Display of EL3204 firmware version	188
Fig. 171 Firmware Update	189
Fig. 172 FPGA firmware version definition	191
Fig. 173 Context menu Properties	191
Fig. 174 Dialog Advanced Settings	192
Fig. 175 Multiple selection and firmware update	194
Fig. 176 Selecting the "Restore default parameters" PDO	195
Fig. 177 Entering a restore value in the Set Value dialog.....	195