

Documentation

EL6861

BACnet-MS/TP Terminal

Version: 1.0
Date: 2018-08-22

BECKHOFF

Table of Contents

1	Foreword	5
1.1	Notes on the documentation.....	5
1.2	Safety instructions	6
1.3	Documentation issue status	7
1.4	Version identification of EtherCAT devices	7
2	Product overview	11
2.1	Introduction.....	11
2.2	Technical data	12
2.3	Start	12
3	Basics communication	13
3.1	EtherCAT basics.....	13
3.2	EtherCAT cabling – wire-bound.....	13
3.3	General notes for setting the watchdog.....	14
3.4	EtherCAT State Machine	16
3.5	CoE Interface.....	18
4	Installation	23
4.1	Instructions for ESD protection	23
4.2	Installation on mounting rails	23
4.3	Installation positions	26
4.4	Positioning of passive Terminals	28
4.5	EL6861 - LEDs and connection.....	30
5	Configuration of the MS/TP Supplement	32
6	Commissioning	35
6.1	TwinCAT Quick Start	35
6.1.1	TwinCAT 2	37
6.1.2	TwinCAT 3	47
6.2	TwinCAT Development Environment	59
6.2.1	Installation of the TwinCAT real-time driver.....	59
6.2.2	Notes regarding ESI device description.....	65
6.2.3	TwinCAT ESI Updater	69
6.2.4	Distinction between Online and Offline.....	69
6.2.5	OFFLINE configuration creation	70
6.2.6	ONLINE configuration creation	75
6.2.7	EtherCAT subscriber configuration.....	83
6.3	General Notes - EtherCAT Slave Application.....	93
6.4	Configuration	101
6.5	Object description and parameterization	110
6.5.1	Restore object.....	111
6.5.2	Configuration data	111
6.5.3	Input data	112
6.5.4	Output data	112
6.5.5	Information data	113
6.5.6	Diagnostic data	113

6.6	Object description - standard objects	113
7	Appendix	118
7.1	EtherCAT AL Status Codes	118
7.2	Firmware compatibility	118
7.3	Firmware Update EL/ES/EM/EPxxxx	118
7.3.1	Device description ESI file/XML	119
7.3.2	Firmware explanation	122
7.3.3	Updating controller firmware *.efw	123
7.3.4	FPGA firmware *.rbf	125
7.3.5	Simultaneous updating of several EtherCAT devices	129
7.4	Restoring the delivery state	130
7.5	Support and Service	131

1 Foreword

1.1 Notes on the documentation

Intended audience

This description is only intended for the use of trained specialists in control and automation engineering who are familiar with the applicable national standards.

It is essential that the documentation and the following notes and explanations are followed when installing and commissioning these components.

It is the duty of the technical personnel to use the documentation published at the respective time of each installation and commissioning.

The responsible staff must ensure that the application or use of the products described satisfy all the requirements for safety, including all the relevant laws, regulations, guidelines and standards.

Disclaimer

The documentation has been prepared with care. The products described are, however, constantly under development.

We reserve the right to revise and change the documentation at any time and without prior announcement.

No claims for the modification of products that have already been supplied may be made on the basis of the data, diagrams and descriptions in this documentation.

Trademarks

Beckhoff®, TwinCAT®, EtherCAT®, Safety over EtherCAT®, TwinSAFE®, XFC® and XTS® are registered trademarks of and licensed by Beckhoff Automation GmbH.

Other designations used in this publication may be trademarks whose use by third parties for their own purposes could violate the rights of the owners.

Patent Pending

The EtherCAT Technology is covered, including but not limited to the following patent applications and patents: EP1590927, EP1789857, DE102004044764, DE102007017835 with corresponding applications or registrations in various other countries.

The TwinCAT Technology is covered, including but not limited to the following patent applications and patents: EP0851348, US6167425 with corresponding applications or registrations in various other countries.



EtherCAT® is registered trademark and patented technology, licensed by Beckhoff Automation GmbH, Germany

Copyright

© Beckhoff Automation GmbH & Co. KG, Germany.

The reproduction, distribution and utilization of this document as well as the communication of its contents to others without express authorization are prohibited.

Offenders will be held liable for the payment of damages. All rights reserved in the event of the grant of a patent, utility model or design.

1.2 Safety instructions

Safety regulations

Please note the following safety instructions and explanations!
Product-specific safety instructions can be found on following pages or in the areas mounting, wiring, commissioning etc.

Exclusion of liability

All the components are supplied in particular hardware and software configurations appropriate for the application. Modifications to hardware or software configurations other than those described in the documentation are not permitted, and nullify the liability of Beckhoff Automation GmbH & Co. KG.

Personnel qualification

This description is only intended for trained specialists in control, automation and drive engineering who are familiar with the applicable national standards.

Description of instructions

In this documentation the following instructions are used.
These instructions must be read carefully and followed without fail!

DANGER

Serious risk of injury!

Failure to follow this safety instruction directly endangers the life and health of persons.

WARNING

Risk of injury!

Failure to follow this safety instruction endangers the life and health of persons.

CAUTION

Personal injuries!

Failure to follow this safety instruction can lead to injuries to persons.

NOTE

Damage to environment/equipment or data loss

Failure to follow this instruction can lead to environmental damage, equipment damage or data loss.



Tip or pointer

This symbol indicates information that contributes to better understanding.

1.3 Documentation issue status

Version	Comment
1.0	<ul style="list-style-type: none"> • Complements, corrections • 1st public issue
0.4	<ul style="list-style-type: none"> • Complements, corrections
0.3	<ul style="list-style-type: none"> • Complements, corrections
0.2	<ul style="list-style-type: none"> • Complements, corrections
0.1	<ul style="list-style-type: none"> • Preliminary documentation for EL6861

1.4 Version identification of EtherCAT devices

Designation

A Beckhoff EtherCAT device has a 14-digit designation, made up of

- family key
- type
- version
- revision

Example	Family	Type	Version	Revision
EL3314-0000-0016	EL terminal (12 mm, non-pluggable connection level)	3314 (4-channel thermocouple terminal)	0000 (basic type)	0016
ES3602-0010-0017	ES terminal (12 mm, pluggable connection level)	3602 (2-channel voltage measurement)	0010 (high-precision version)	0017
CU2008-0000-0000	CU device	2008 (8-port fast ethernet switch)	0000 (basic type)	0000

Notes

- The elements mentioned above result in the **technical designation**. EL3314-0000-0016 is used in the example below.
- EL3314-0000 is the order identifier, in the case of “-0000” usually abbreviated to EL3314. “-0016” is the EtherCAT revision.
- The **order identifier** is made up of
 - family key (EL, EP, CU, ES, KL, CX, etc.)
 - type (3314)
 - version (-0000)
- The **revision** -0016 shows the technical progress, such as the extension of features with regard to the EtherCAT communication, and is managed by Beckhoff.
In principle, a device with a higher revision can replace a device with a lower revision, unless specified otherwise, e.g. in the documentation.
Associated and synonymous with each revision there is usually a description (ESI, EtherCAT Slave Information) in the form of an XML file, which is available for download from the Beckhoff web site.
From 2014/01 the revision is shown on the outside of the IP20 terminals, see Fig. “*EL5021 EL terminal, standard IP20 IO device with batch number and revision ID (since 2014/01)*”.
- The type, version and revision are read as decimal numbers, even if they are technically saved in hexadecimal.

Identification number

Beckhoff EtherCAT devices from the different lines have different kinds of identification numbers:

Production lot/batch number/serial number/date code/D number

The serial number for Beckhoff IO devices is usually the 8-digit number printed on the device or on a sticker. The serial number indicates the configuration in delivery state and therefore refers to a whole production batch, without distinguishing the individual modules of a batch.

Structure of the serial number: **KK YY FF HH**

KK - week of production (CW, calendar week)

YY - year of production

FF - firmware version

HH - hardware version

Example with

Ser. no.: 12063A02: 12 - production week 12 06 - production year 2006 3A - firmware version 3A 02 - hardware version 02

Exceptions can occur in the **IP67 area**, where the following syntax can be used (see respective device documentation):

Syntax: D ww yy x y z u

D - prefix designation

ww - calendar week

yy - year

x - firmware version of the bus PCB

y - hardware version of the bus PCB

z - firmware version of the I/O PCB

u - hardware version of the I/O PCB

Example: D.22081501 calendar week 22 of the year 2008 firmware version of bus PCB: 1 hardware version of bus PCB: 5 firmware version of I/O PCB: 0 (no firmware necessary for this PCB) hardware version of I/O PCB: 1

Unique serial number/ID, ID number

In addition, in some series each individual module has its own unique serial number.

See also the further documentation in the area

- IP67: [EtherCAT Box](#)
- Safety: [TwinSafe](#)
- Terminals with factory calibration certificate and other measuring terminals

Examples of markings



Fig. 1: EL5021 EL terminal, standard IP20 IO device with serial/ batch number and revision ID (since 2014/01)



Fig. 2: EK1100 EtherCAT coupler, standard IP20 IO device with serial/ batch number



Fig. 3: CU2016 switch with serial/ batch number

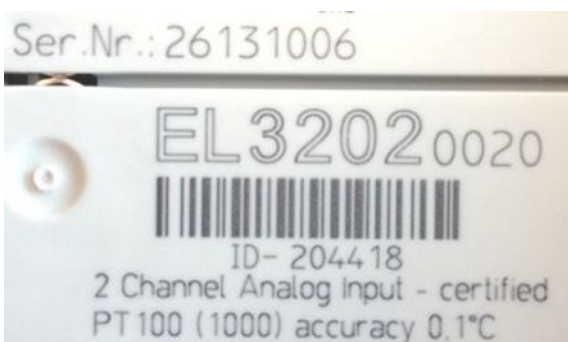

Fig. 4: EL3202-0020 with serial/ batch number 26131006 and unique ID-number 204418

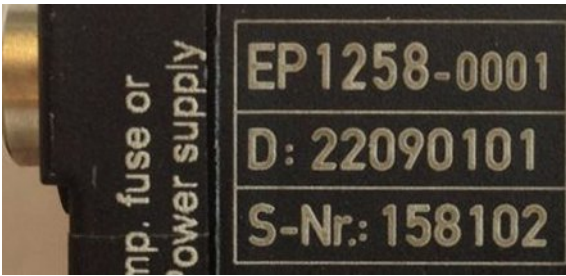

Fig. 5: EP1258-0001 IP67 EtherCAT Box with batch number/ date code 22090101 and unique serial number 158102

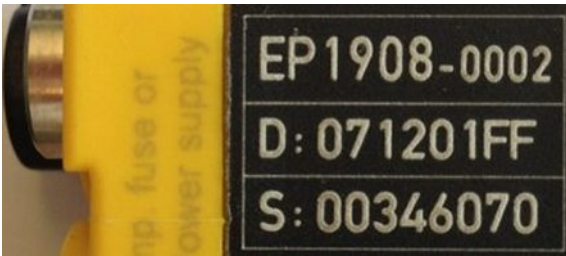

Fig. 6: EP1908-0002 IP67 EtherCAT Safety Box with batch number/ date code 071201FF and unique serial number 00346070



Fig. 7: EL2904 IP20 safety terminal with batch number/ date code 50110302 and unique serial number 00331701



Fig. 8: ELM3604-0002 terminal with unique ID number (QR code) 100001051 and serial/ batch number 44160201

2 Product overview

2.1 Introduction

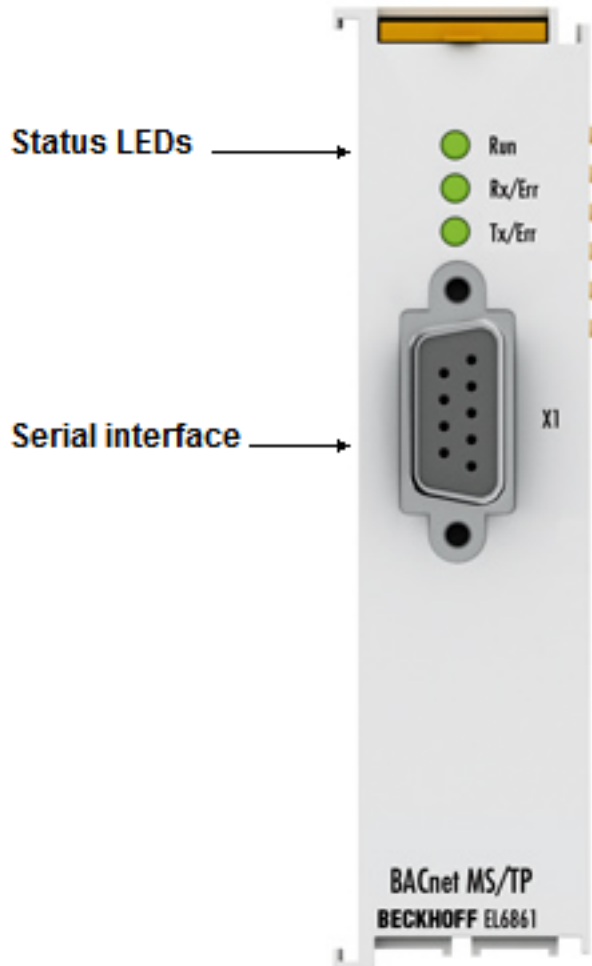

Fig. 9: EL6861

1-channel BACnet MS/TP interface RS485, D-sub connection

The EL6861 serial interface enables the connection of BACnet MS/TP devices (Master-Slave/Token-Passing) via an RS485 interface. Up to 32 MS/TP devices (up to 64 if ultra-low power transceivers are used) can be connected. Use the EL6861 interface only in combination with TwinCAT and CX9020 as a minimum, since the BACnet MS/TP driver integrated in TwinCAT implements the communication via the MS/TP protocol (BACnet revision 12). The configuration is also done in TwinCAT.

The RS485 interface guarantees high interference immunity through electrically isolated signals. The EL6861 provides 1 x 5 V DC at 20 mA (electrically isolated, short-circuit proof) from the E-bus supply for use with the bias resistors (network bias).

The following devices are typically connected to the EL6861:

- Frequency converters
- Pumps
- Drives (especially valve drives)

- Room control units
- Compact controllers (e.g. volume flow regulators)

Quick links

- [Technical data \[► 12\]](#)
- [EtherCAT basics](#)
- [Basics and functionality \[► 32\]](#)
- [Configuration \[► 101\]](#)

2.2 Technical data

Technical data	EL6861-0000
Technology	D-sub, 9-pin
Devices	32, up to 64 if ultra-low power transceivers are used
Data transfer channels	1
Data transfer rates	9600, 19,200, 38,400, 57,600, 76,800 and 115,200 baud (default: 9600 baud)
Interfaces	1 x RS485
Termination resistor	externally via plug ZB3100 or ZS1031-3000
Bias resistor (network bias)	externally via plug ZB3100 or ZS1031-3000
Cable length	max. 500 m twisted-pair
Providing external supply	1 x max. 5 V/20 mA, from E-bus supply, short-circuit proof
Power supply	via the E-bus
Dimensions (W x H x D)	approx. 26 mm x 100 mm x 52 mm (width aligned: 23 mm)
Weight	approx. 70 g
Mounting [► 23]	on 35 mm mounting rail according to EN 60715
Operating temperature	-25°C ... +60°C
Storage temperature	-40°C ... +85°C
Relative humidity	95% no condensation
Vibration/shock resistance	conforms to EN 60068-2-6/EN 60068-2-27
EMC immunity/emission	conforms to EN 61000-6-2/EN 61000-6-4
Protect. class / installation pos.	IP20 / see note [► 26] !
Approvals	CE

2.3 Start

For commissioning:

- mount the EL6861 as described in the chapter [Mounting and wiring](#)
- configure the EL6861 in TwinCAT as described in the chapter [Commissioning \[► 101\]](#).

3 Basics communication

3.1 EtherCAT basics

Please refer to the chapter [EtherCAT System Documentation](#) for the EtherCAT fieldbus basics.

3.2 EtherCAT cabling – wire-bound

The cable length between two EtherCAT devices must not exceed 100 m. This results from the FastEthernet technology, which, above all for reasons of signal attenuation over the length of the cable, allows a maximum link length of 5 + 90 + 5 m if cables with appropriate properties are used. See also the [Design recommendations for the infrastructure for EtherCAT/Ethernet](#).

Cables and connectors

For connecting EtherCAT devices only Ethernet connections (cables + plugs) that meet the requirements of at least category 5 (Cat5) according to EN 50173 or ISO/IEC 11801 should be used. EtherCAT uses 4 wires for signal transfer.

EtherCAT uses RJ45 plug connectors, for example. The pin assignment is compatible with the Ethernet standard (ISO/IEC 8802-3).

Pin	Color of conductor	Signal	Description
1	yellow	TD +	Transmission Data +
2	orange	TD -	Transmission Data -
3	white	RD +	Receiver Data +
6	blue	RD -	Receiver Data -

Due to automatic cable detection (auto-crossing) symmetric (1:1) or cross-over cables can be used between EtherCAT devices from Beckhoff.



Recommended cables

Suitable cables for the connection of EtherCAT devices can be found on the Beckhoff website!

E-Bus supply

A bus coupler can supply the EL terminals added to it with the E-bus system voltage of 5 V; a coupler is thereby loadable up to 2 A as a rule (see details in respective device documentation). Information on how much current each EL terminal requires from the E-bus supply is available online and in the catalogue. If the added terminals require more current than the coupler can supply, then power feed terminals (e.g. [EL9410](#)) must be inserted at appropriate places in the terminal strand.

The pre-calculated theoretical maximum E-Bus current is displayed in the TwinCAT System Manager. A shortfall is marked by a negative total amount and an exclamation mark; a power feed terminal is to be placed before such a position.

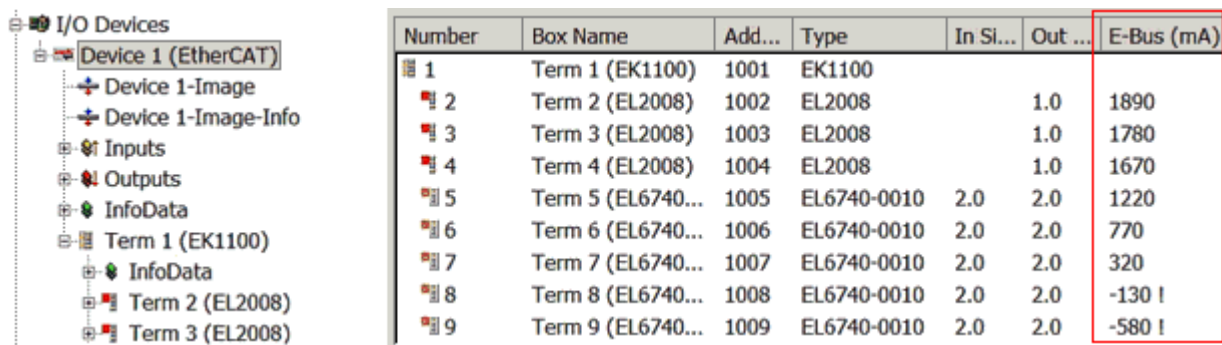

Fig. 10: System manager current calculation

NOTE

Malfunction possible!
 The same ground potential must be used for the E-Bus supply of all EtherCAT terminals in a terminal block!

3.3 General notes for setting the watchdog

ELxxxx terminals are equipped with a safety feature (watchdog) that switches off the outputs after a specifiable time e.g. in the event of an interruption of the process data traffic, depending on the device and settings, e.g. in OFF state.

The EtherCAT slave controller (ESC) in the EL2xxx terminals features 2 watchdogs:

- SM watchdog (default: 100 ms)
- PDI watchdog (default: 100 ms)

SM watchdog (SyncManager Watchdog)

The SyncManager watchdog is reset after each successful EtherCAT process data communication with the terminal. If no EtherCAT process data communication takes place with the terminal for longer than the set and activated SM watchdog time, e.g. in the event of a line interruption, the watchdog is triggered and the outputs are set to FALSE. The OP state of the terminal is unaffected. The watchdog is only reset after a successful EtherCAT process data access. Set the monitoring time as described below.

The SyncManager watchdog monitors correct and timely process data communication with the ESC from the EtherCAT side.

PDI watchdog (Process Data Watchdog)

If no PDI communication with the EtherCAT slave controller (ESC) takes place for longer than the set and activated PDI watchdog time, this watchdog is triggered.

PDI (Process Data Interface) is the internal interface between the ESC and local processors in the EtherCAT slave, for example. The PDI watchdog can be used to monitor this communication for failure.

The PDI watchdog monitors correct and timely process data communication with the ESC from the application side.

The settings of the SM- and PDI-watchdog must be done for each slave separately in the TwinCAT System Manager.

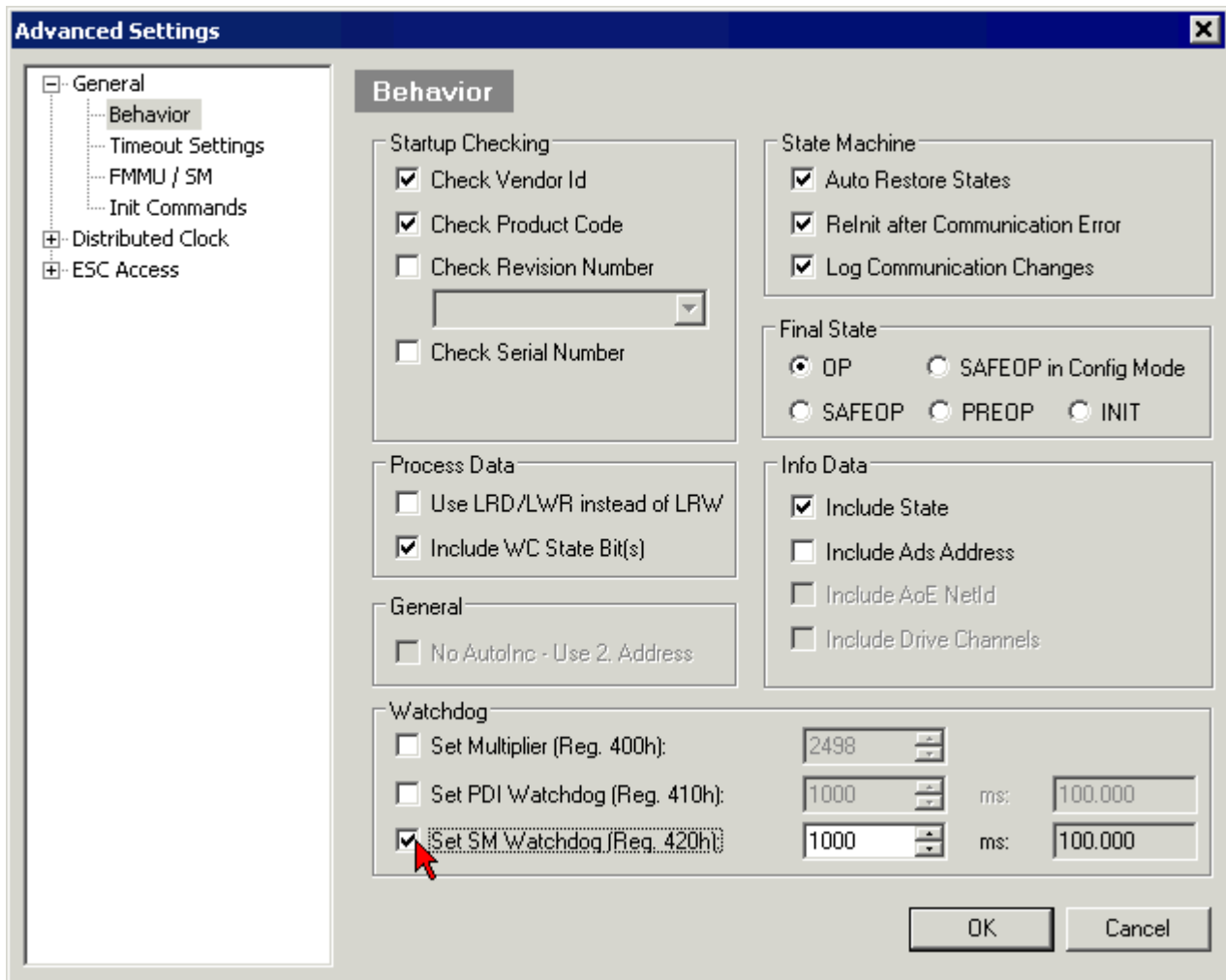

Fig. 11: EtherCAT tab -> Advanced Settings -> Behavior -> Watchdog

Notes:

- the multiplier is valid for both watchdogs.
- each watchdog has its own timer setting, the outcome of this in summary with the multiplier is a resulting time.
- Important: the multiplier/timer setting is only loaded into the slave at the start up, if the checkbox is activated.
If the checkbox is not activated, nothing is downloaded and the ESC settings remain unchanged.

Multiplier

Multiplier

Both watchdogs receive their pulses from the local terminal cycle, divided by the watchdog multiplier:

$$1/25 \text{ MHz} * (\text{watchdog multiplier} + 2) = 100 \mu\text{s} \text{ (for default setting of 2498 for the multiplier)}$$

The standard setting of 1000 for the SM watchdog corresponds to a release time of 100 ms.

The value in multiplier + 2 corresponds to the number of basic 40 ns ticks representing a watchdog tick. The multiplier can be modified in order to adjust the watchdog time over a larger range.

Example "Set SM watchdog"

This checkbox enables manual setting of the watchdog times. If the outputs are set and the EtherCAT communication is interrupted, the SM watchdog is triggered after the set time and the outputs are erased. This setting can be used for adapting a terminal to a slower EtherCAT master or long cycle times. The default SM watchdog setting is 100 ms. The setting range is 0..65535. Together with a multiplier with a range of 1..65535 this covers a watchdog period between 0..~170 seconds.

Calculation

Multiplier = 2498 → watchdog base time = $1 / 25 \text{ MHz} * (2498 + 2) = 0.0001 \text{ seconds} = 100 \mu\text{s}$
 SM watchdog = 10000 → $10000 * 100 \mu\text{s} = 1 \text{ second watchdog monitoring time}$

⚠ CAUTION**Undefined state possible!**

The function for switching off of the SM watchdog via SM watchdog = 0 is only implemented in terminals from version -0016. In previous versions this operating mode should not be used.

⚠ CAUTION**Damage of devices and undefined state possible!**

If the SM watchdog is activated and a value of 0 is entered the watchdog switches off completely. This is the deactivation of the watchdog! Set outputs are NOT set in a safe state, if the communication is interrupted.

3.4 EtherCAT State Machine

The state of the EtherCAT slave is controlled via the EtherCAT State Machine (ESM). Depending upon the state, different functions are accessible or executable in the EtherCAT slave. Specific commands must be sent by the EtherCAT master to the device in each state, particularly during the bootup of the slave.

A distinction is made between the following states:

- Init
- Pre-Operational
- Safe-Operational and
- Operational
- Boot

The regular state of each EtherCAT slave after bootup is the OP state.

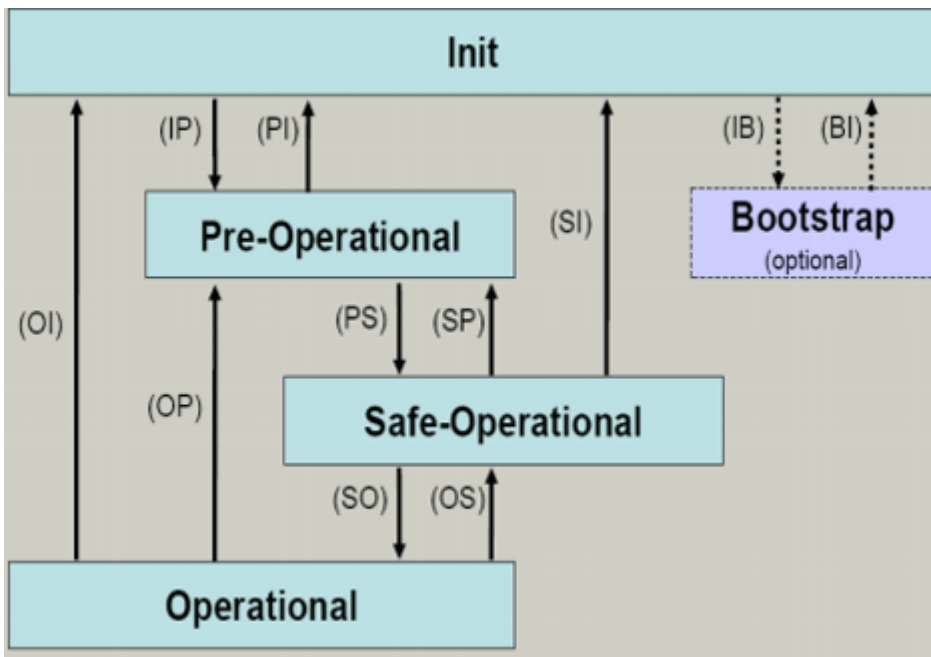

Fig. 12: States of the EtherCAT State Machine

Init

After switch-on the EtherCAT slave in the *Init* state. No mailbox or process data communication is possible. The EtherCAT master initializes sync manager channels 0 and 1 for mailbox communication.

Pre-Operational (Pre-Op)

During the transition between *Init* and *Pre-Op* the EtherCAT slave checks whether the mailbox was initialized correctly.

In *Pre-Op* state mailbox communication is possible, but not process data communication. The EtherCAT master initializes the sync manager channels for process data (from sync manager channel 2), the FMMU channels and, if the slave supports configurable mapping, PDO mapping or the sync manager PDO assignment. In this state the settings for the process data transfer and perhaps terminal-specific parameters that may differ from the default settings are also transferred.

Safe-Operational (Safe-Op)

During transition between *Pre-Op* and *Safe-Op* the EtherCAT slave checks whether the sync manager channels for process data communication and, if required, the distributed clocks settings are correct. Before it acknowledges the change of state, the EtherCAT slave copies current input data into the associated DP-RAM areas of the EtherCAT slave controller (ECSC).

In *Safe-Op* state mailbox and process data communication is possible, although the slave keeps its outputs in a safe state, while the input data are updated cyclically.

● Outputs in SAFEOP state

i The default set `watchdog [▶ 14]` monitoring sets the outputs of the module in a safe state - depending on the settings in SAFEOP and OP - e.g. in OFF state. If this is prevented by deactivation of the watchdog monitoring in the module, the outputs can be switched or set also in the SAFEOP state.

Operational (Op)

Before the EtherCAT master switches the EtherCAT slave from *Safe-Op* to *Op* it must transfer valid output data.

In the *Op* state the slave copies the output data of the masters to its outputs. Process data and mailbox communication is possible.

Boot

In the *Boot* state the slave firmware can be updated. The *Boot* state can only be reached via the *Init* state.

In the *Boot* state mailbox communication via the *file access over EtherCAT* (FoE) protocol is possible, but no other mailbox communication and no process data communication.

3.5 CoE Interface

General description

The CoE interface (CANopen over EtherCAT) is used for parameter management of EtherCAT devices. EtherCAT slaves or the EtherCAT master manage fixed (read only) or variable parameters which they require for operation, diagnostics or commissioning.

CoE parameters are arranged in a table hierarchy. In principle, the user has read access via the fieldbus. The EtherCAT master (TwinCAT System Manager) can access the local CoE lists of the slaves via EtherCAT in read or write mode, depending on the attributes.

Different CoE parameter types are possible, including string (text), integer numbers, Boolean values or larger byte fields. They can be used to describe a wide range of features. Examples of such parameters include manufacturer ID, serial number, process data settings, device name, calibration values for analog measurement or passwords.

The order is specified in 2 levels via hexadecimal numbering: (main)index, followed by subindex. The value ranges are

- Index: 0x0000 ...0xFFFF (0...65535_{dez})
- SubIndex: 0x00...0xFF (0...255_{dez})

A parameter localized in this way is normally written as 0x8010:07, with preceding "x" to identify the hexadecimal numerical range and a colon between index and subindex.

The relevant ranges for EtherCAT fieldbus users are:

- 0x1000: This is where fixed identity information for the device is stored, including name, manufacturer, serial number etc., plus information about the current and available process data configurations.
- 0x8000: This is where the operational and functional parameters for all channels are stored, such as filter settings or output frequency.

Other important ranges are:

- 0x4000: In some EtherCAT devices the channel parameters are stored here (as an alternative to the 0x8000 range).
- 0x6000: Input PDOs ("input" from the perspective of the EtherCAT master)
- 0x7000: Output PDOs ("output" from the perspective of the EtherCAT master)

● Availability



Not every EtherCAT device must have a CoE list. Simple I/O modules without dedicated processor usually have no variable parameters and therefore no CoE list.

If a device has a CoE list, it is shown in the TwinCAT System Manager as a separate tab with a listing of the elements:

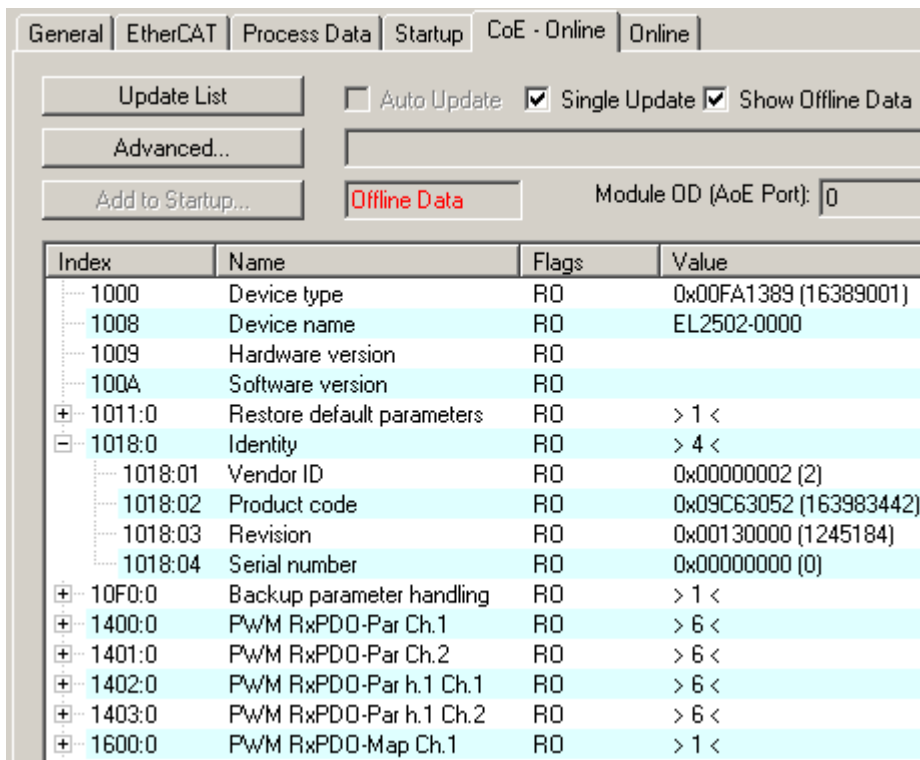

Fig. 13: "CoE Online " tab

The figure above shows the CoE objects available in device "EL2502", ranging from 0x1000 to 0x1600. The subindices for 0x1018 are expanded.

Data management and function "NoCoeStorage"

Some parameters, particularly the setting parameters of the slave, are configurable and writeable. This can be done in write or read mode

- via the System Manager (Fig. "CoE Online " tab) by clicking
This is useful for commissioning of the system/slaves. Click on the row of the index to be parameterised and enter a value in the "SetValue" dialog.
- from the control system/PLC via ADS, e.g. through blocks from the TcEtherCAT.lib library
This is recommended for modifications while the system is running or if no System Manager or operating staff are available.

Data management

I If slave CoE parameters are modified online, Beckhoff devices store any changes in a fail-safe manner in the EEPROM, i.e. the modified CoE parameters are still available after a restart. The situation may be different with other manufacturers.

An EEPROM is subject to a limited lifetime with respect to write operations. From typically 100,000 write operations onwards it can no longer be guaranteed that new (changed) data are reliably saved or are still readable. This is irrelevant for normal commissioning. However, if CoE parameters are continuously changed via ADS at machine runtime, it is quite possible for the lifetime limit to be reached. Support for the NoCoeStorage function, which suppresses the saving of changed CoE values, depends on the firmware version.

Please refer to the technical data in this documentation as to whether this applies to the respective device.

- If the function is supported: the function is activated by entering the code word 0x12345678 once in CoE 0xF008 and remains active as long as the code word is not changed. After switching the device on it is then inactive. Changed CoE values are not saved in the EEPROM and can thus be changed any number of times.
- Function is not supported: continuous changing of CoE values is not permissible in view of the lifetime limit.

Startup list

Changes in the local CoE list of the terminal are lost if the terminal is replaced. If a terminal is replaced with a new Beckhoff terminal, it will have the default settings. It is therefore advisable to link all changes in the CoE list of an EtherCAT slave with the Startup list of the slave, which is processed whenever the EtherCAT fieldbus is started. In this way a replacement EtherCAT slave can automatically be parameterized with the specifications of the user.

If EtherCAT slaves are used which are unable to store local CoE values permanently, the Startup list must be used.

Recommended approach for manual modification of CoE parameters

- Make the required change in the System Manager
The values are stored locally in the EtherCAT slave
- If the value is to be stored permanently, enter it in the Startup list.
The order of the Startup entries is usually irrelevant.

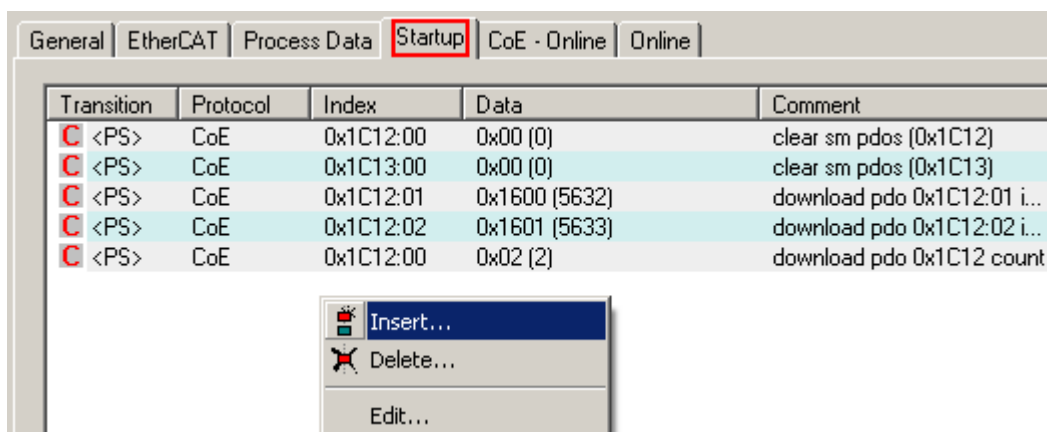

Fig. 14: Startup list in the TwinCAT System Manager

The Startup list may already contain values that were configured by the System Manager based on the ESI specifications. Additional application-specific entries can be created.

Online/offline list

While working with the TwinCAT System Manager, a distinction has to be made whether the EtherCAT device is "available", i.e. switched on and linked via EtherCAT and therefore **online**, or whether a configuration is created **offline** without connected slaves.

In both cases a CoE list as shown in Fig. "CoE online' tab" is displayed. The connectivity is shown as offline/online.

- If the slave is offline
 - The offline list from the ESI file is displayed. In this case modifications are not meaningful or possible.
 - The configured status is shown under Identity.
 - No firmware or hardware version is displayed, since these are features of the physical device.
 - **Offline** is shown in red.

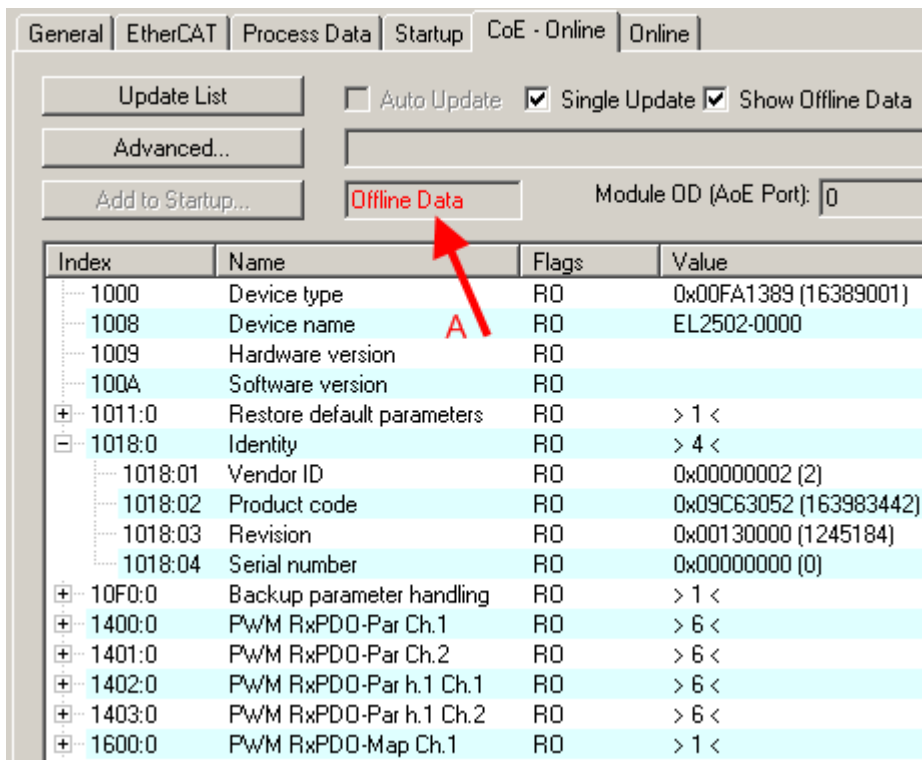

Fig. 15: Offline list

- If the slave is online
 - The actual current slave list is read. This may take several seconds, depending on the size and cycle time.
 - The actual identity is displayed
 - The firmware and hardware version of the equipment according to the electronic information is displayed
 - **Online** is shown in green.

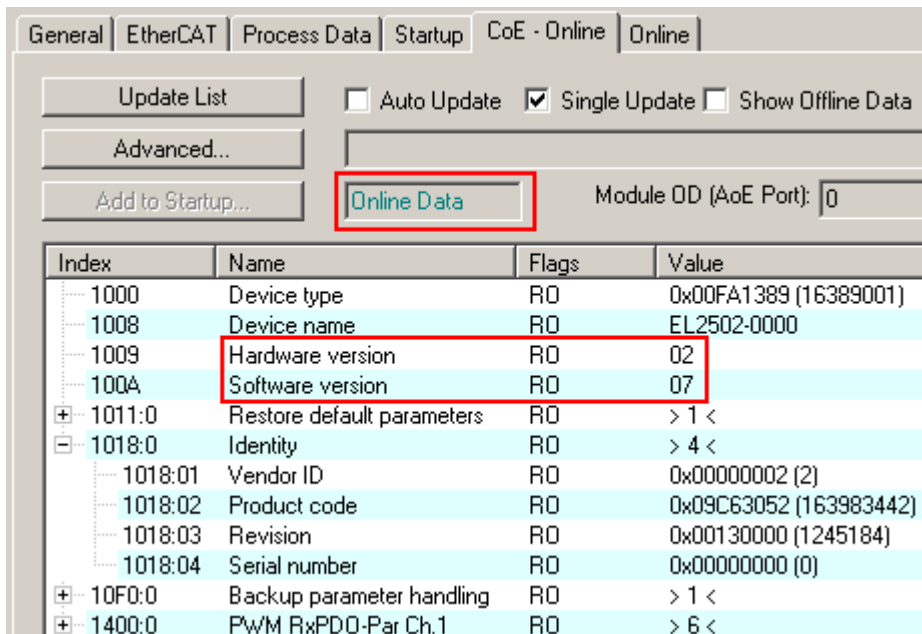

Fig. 16: Online list

Channel-based order

The CoE list is available in EtherCAT devices that usually feature several functionally equivalent channels. For example, a 4-channel analog 0..10 V input terminal also has 4 logical channels and therefore 4 identical sets of parameter data for the channels. In order to avoid having to list each channel in the documentation, the placeholder "n" tends to be used for the individual channel numbers.

In the CoE system 16 indices, each with 255 subindices, are generally sufficient for representing all channel parameters. The channel-based order is therefore arranged in $16_{\text{dec}}/10_{\text{hex}}$ steps. The parameter range 0x8000 exemplifies this:

- Channel 0: parameter range 0x8000:00 ... 0x800F:255
- Channel 1: parameter range 0x8010:00 ... 0x801F:255
- Channel 2: parameter range 0x8020:00 ... 0x802F:255
- ...

This is generally written as 0x80n0.

Detailed information on the CoE interface can be found in the [EtherCAT system documentation](#) on the Beckhoff website.

4 Installation

4.1 Instructions for ESD protection

NOTE

Destruction of the devices by electrostatic discharge possible!

The devices contain components at risk from electrostatic discharge caused by improper handling.

- ✓ Please ensure you are electrostatically discharged and avoid touching the contacts of the device directly.
- a) Avoid contact with highly insulating materials (synthetic fibers, plastic film etc.).
- b) Surroundings (working place, packaging and personnel) should be grounded probably, when handling with the devices.
- c) Each assembly must be terminated at the right hand end with an [EL9011](#) or [EL9012](#) bus end cap, to ensure the protection class and ESD protection.



Fig. 17: Spring contacts of the Beckhoff I/O components

4.2 Installation on mounting rails

⚠ WARNING

Risk of electric shock and damage of device!

Bring the bus terminal system into a safe, powered down state before starting installation, disassembly or wiring of the bus terminals!

Assembly

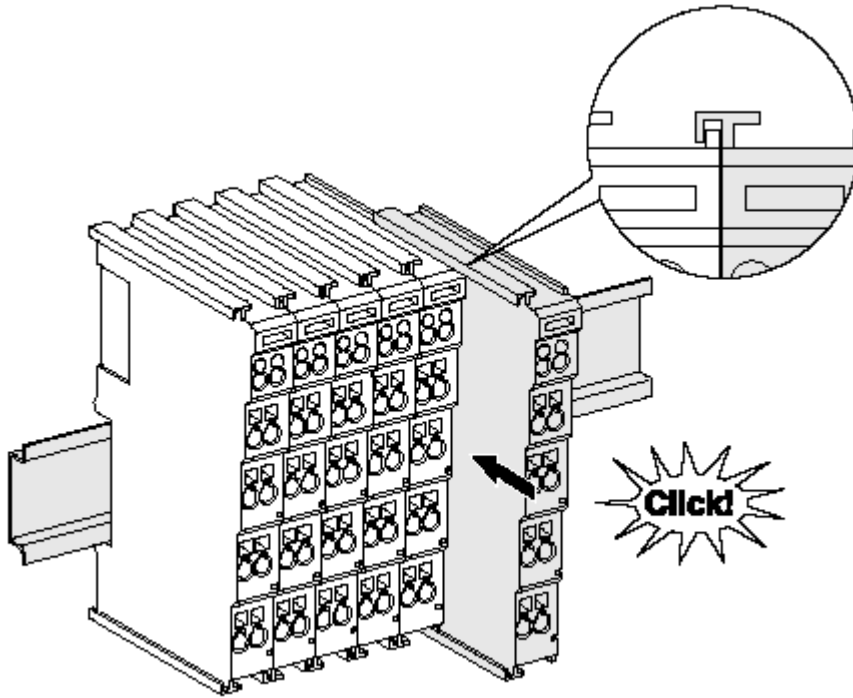

Fig. 18: Attaching on mounting rail

The bus coupler and bus terminals are attached to commercially available 35 mm mounting rails (DIN rails according to EN 60715) by applying slight pressure:

1. First attach the fieldbus coupler to the mounting rail.
2. The bus terminals are now attached on the right-hand side of the fieldbus coupler. Join the components with tongue and groove and push the terminals against the mounting rail, until the lock clicks onto the mounting rail.

If the terminals are clipped onto the mounting rail first and then pushed together without tongue and groove, the connection will not be operational! When correctly assembled, no significant gap should be visible between the housings.

i Fixing of mounting rails

The locking mechanism of the terminals and couplers extends to the profile of the mounting rail. At the installation, the locking mechanism of the components must not come into conflict with the fixing bolts of the mounting rail. To mount the mounting rails with a height of 7.5 mm under the terminals and couplers, you should use flat mounting connections (e.g. countersunk screws or blind rivets).

Disassembly

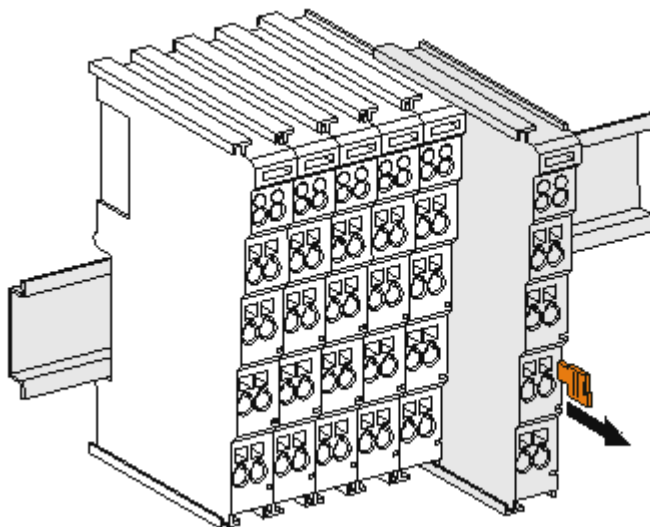

Fig. 19: Disassembling of terminal

Each terminal is secured by a lock on the mounting rail, which must be released for disassembly:

1. Pull the terminal by its orange-colored lugs approximately 1 cm away from the mounting rail. In doing so for this terminal the mounting rail lock is released automatically and you can pull the terminal out of the bus terminal block easily without excessive force.
2. Grasp the released terminal with thumb and index finger simultaneous at the upper and lower grooved housing surfaces and pull the terminal out of the bus terminal block.

Connections within a bus terminal block

The electric connections between the Bus Coupler and the Bus Terminals are automatically realized by joining the components:

- The six spring contacts of the K-Bus/E-Bus deal with the transfer of the data and the supply of the Bus Terminal electronics.
- The power contacts deal with the supply for the field electronics and thus represent a supply rail within the bus terminal block. The power contacts are supplied via terminals on the Bus Coupler (up to 24 V) or for higher voltages via power feed terminals.

● Power Contacts

i During the design of a bus terminal block, the pin assignment of the individual Bus Terminals must be taken account of, since some types (e.g. analog Bus Terminals or digital 4-channel Bus Terminals) do not or not fully loop through the power contacts. Power Feed Terminals (KL91xx, KL92xx or EL91xx, EL92xx) interrupt the power contacts and thus represent the start of a new supply rail.

PE power contact

The power contact labeled PE can be used as a protective earth. For safety reasons this contact mates first when plugging together, and can ground short-circuit currents of up to 125 A.

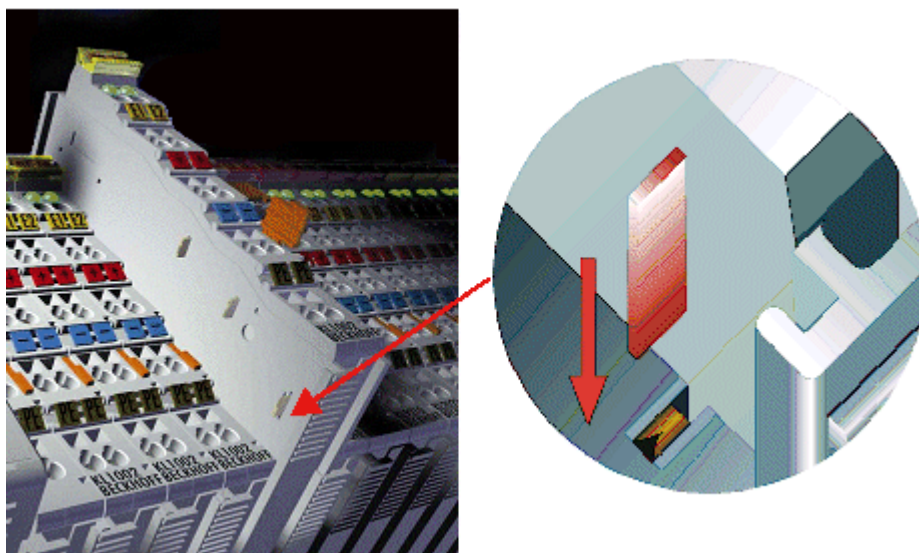

Fig. 20: Power contact on left side

NOTE**Possible damage of the device**

Note that, for reasons of electromagnetic compatibility, the PE contacts are capacitatively coupled to the mounting rail. This may lead to incorrect results during insulation testing or to damage on the terminal (e.g. disruptive discharge to the PE line during insulation testing of a consumer with a nominal voltage of 230 V). For insulation testing, disconnect the PE supply line at the Bus Coupler or the Power Feed Terminal! In order to decouple further feed points for testing, these Power Feed Terminals can be released and pulled at least 10 mm from the group of terminals.

⚠ WARNING**Risk of electric shock!**

The PE power contact must not be used for other potentials!

4.3 Installation positions

NOTE**Constraints regarding installation position and operating temperature range**

Please refer to the technical data for a terminal to ascertain whether any restrictions regarding the installation position and/or the operating temperature range have been specified. When installing high power dissipation terminals ensure that an adequate spacing is maintained between other components above and below the terminal in order to guarantee adequate ventilation!

Optimum installation position (standard)

The optimum installation position requires the mounting rail to be installed horizontally and the connection surfaces of the EL/KL terminals to face forward (see Fig. "Recommended distances for standard installation position"). The terminals are ventilated from below, which enables optimum cooling of the electronics through convection. "From below" is relative to the acceleration of gravity.

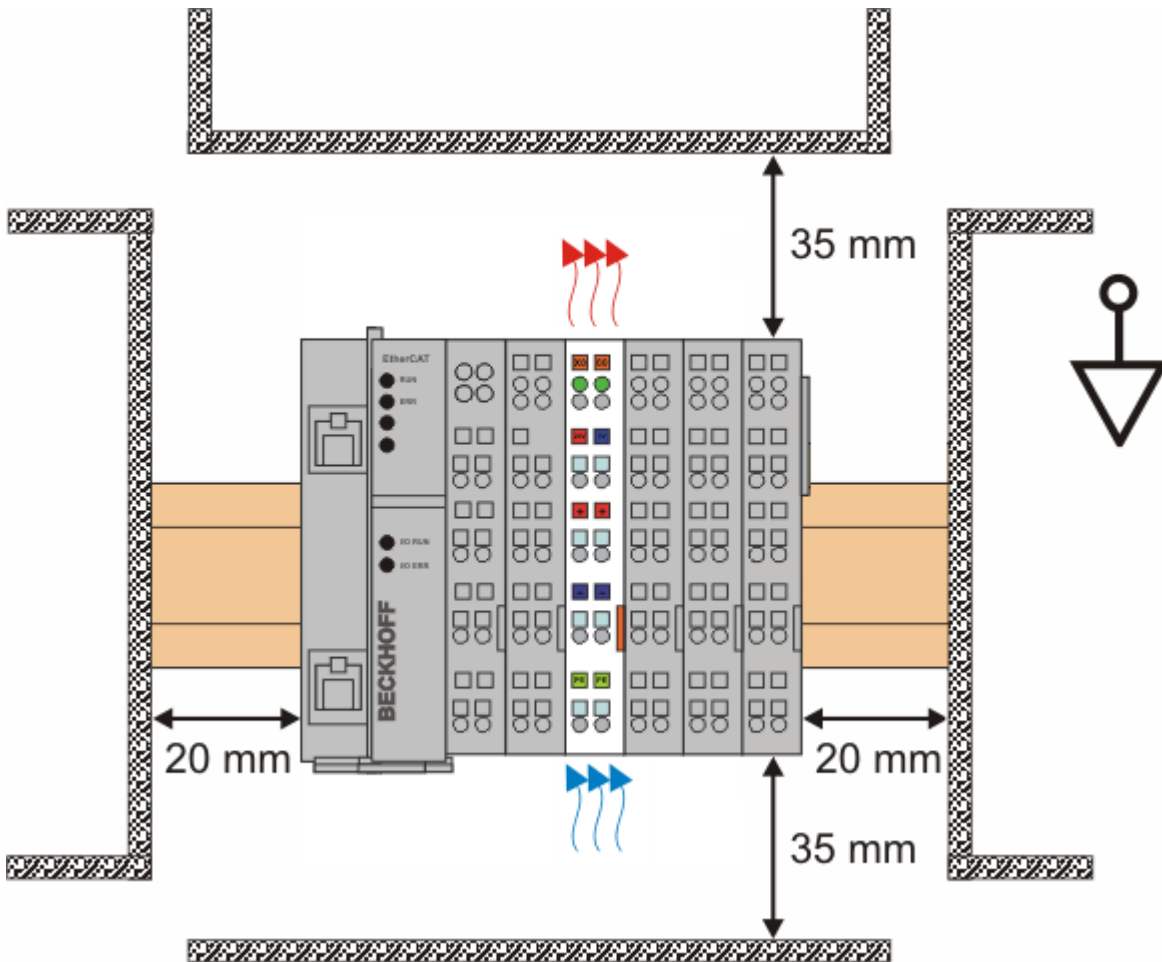

Fig. 21: Recommended distances for standard installation position

Compliance with the distances shown in Fig. “Recommended distances for standard installation position” is recommended.

Other installation positions

All other installation positions are characterized by different spatial arrangement of the mounting rail - see Fig “Other installation positions”.

The minimum distances to ambient specified above also apply to these installation positions.

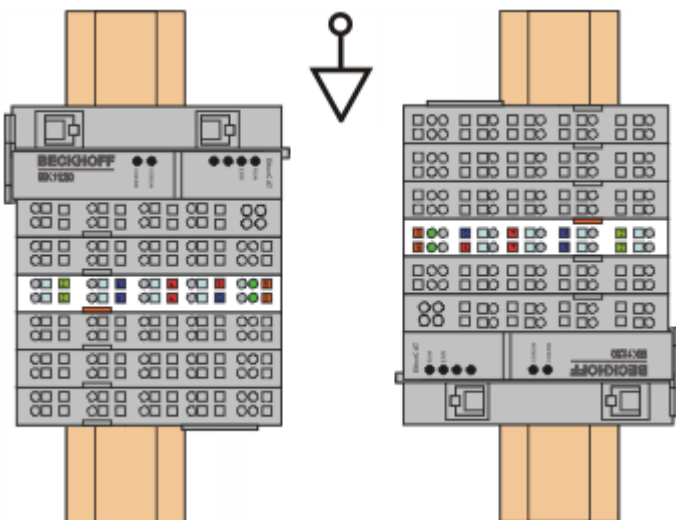

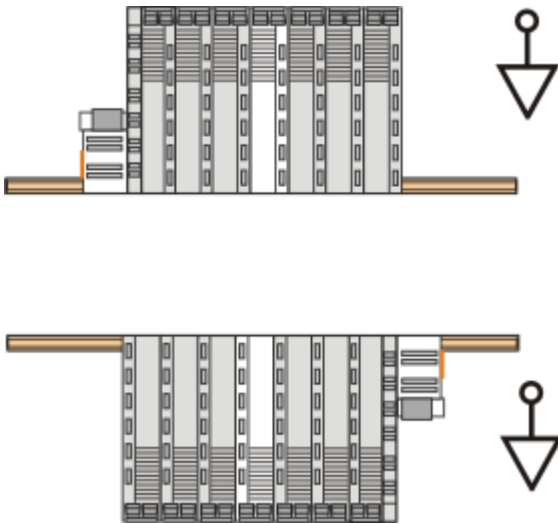

Fig. 22: Other installation positions

4.4 Positioning of passive Terminals

● Hint for positioning of passive terminals in the bus terminal block

i EtherCAT Terminals (ELxxxx / ESxxxx), which do not take an active part in data transfer within the bus terminal block are so called passive terminals. The passive terminals have no current consumption out of the E-Bus.
 To ensure an optimal data transfer, you must not directly string together more than 2 passive terminals!

Examples for positioning of passive terminals (highlighted)

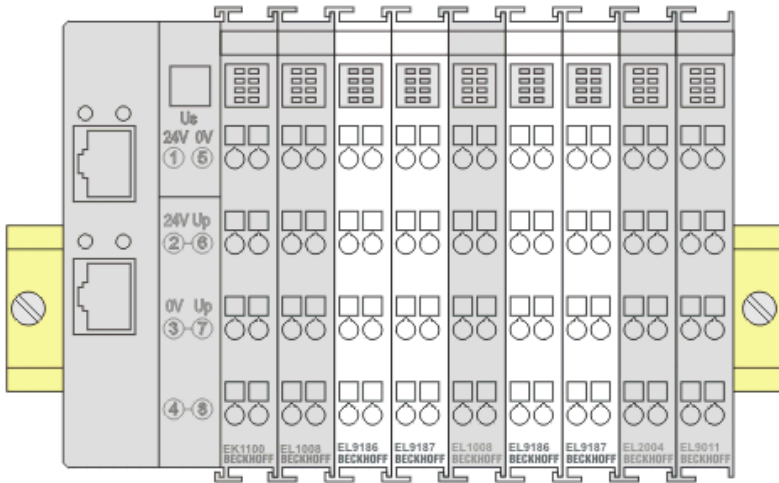

Fig. 23: Correct positioning

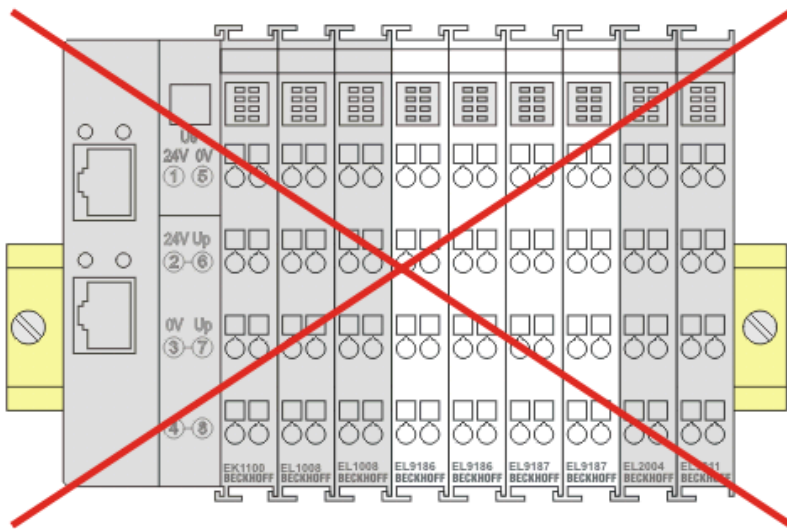

Fig. 24: Incorrect positioning

4.5 EL6861 - LEDs and connection

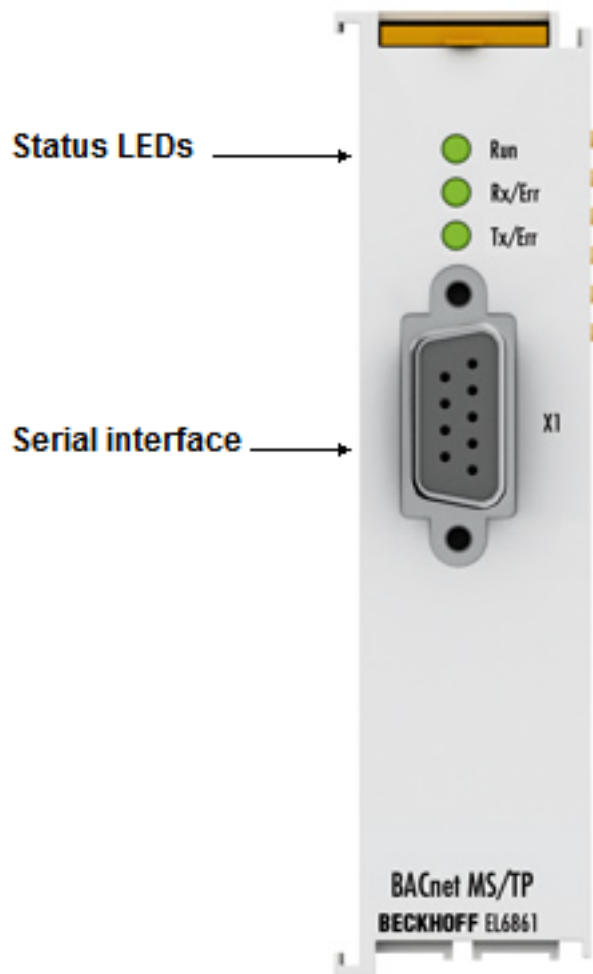

Fig. 25: LEDs and serial interface

LEDs

LED	Color	Meaning	
RUN	green	This LED indicates the terminal's operating state:	
		off	State of the EtherCAT State Machine [▶ 16]: INIT = initialization of the terminal or BOOTSTRAP = function for <u>firmware updates</u> [▶ 118] of the terminal
		flashing	State of the EtherCAT State Machine: PREOP = function for mailbox communication and different default settings set
		single flash	State of the EtherCAT State Machine: SAFEOP = verification of the "Process Data" tab [▶ 84] channels and the distributed clocks. Outputs remain in safe state
		on	State of the EtherCAT State Machine: OP = normal operating state; mailbox and process data communication is possible
Rx/	green	Serial port at this connection receives data	
Err	orange	Frame error (on for 250 ms)	
Tx/	green	Serial port at this connection sends data	
Err	orange	Rx Overrun error (on for 250 ms)	

EL6861 connection

1 x D-Sub connection socket, 9-pin

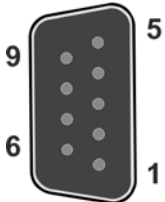
D-sub connector, female (plan view)	Connection (X1)	
	Pin	Connection
	1	n.c.
	2	n.c.
	3	+
	4	n.c.
	5	GND
	6	+5 V DC
	7	n.c.
	8	-
	9	n.c.

5 Configuration of the MS/TP Supplement

MS/TP Introduction

General

MS/TP (Master Slave / Token Passing) specifies connections between BACnet devices using the standard EIA-485 for serial networks. Typical devices using MS/TP include VFD=variable frequency drives, pumps, actuators, room-operating units, sensors or actuators as well as compact air-conditioning units or chillers..

Layer 1 EIA-485

MS/TP networks use an EIA-485 connection. The following requirements shall be fulfilled:

- Twisted Pair cable AWG18 or better(0,82mm² conductor area of the signal wires) with foil or braided shield
- Impedance 100-130 Ohms
- Capacitance <100pF/m (30pF/ft) between conductors
- Capacitance <200pF/m (60pF/ft) between conductors and shield
- Max. (recommended) length of a single segment is 1.200m (4.000ft) with AWG18 cable (0,82mm² conductor area). Depending on the number of connections the actual maximum length of a segment may reduce to 500-700m only. Due to this the maximum specified segment length for the terminal EL6861 is limited to 500m.
- Max. number of devices per segment: 32 (using the terminal EL6861 and devices w/ low-power transceiver: 64 devices per segment)
- Polarity is important, the signal wires are marked: B+, A- (Attention, sometimes devices are marked with an incorrect A+, B-, in this case the signal wires must be swapped).
- To connect segments, segment-repeaters may be used.
- The wiring is specified to use Daisy-Chain only, starting with the first device directly from device to device. Using T-Junctions or star topology is not allowed.
- To prevent from ground-loops, the shield shall only be connected to potential ground at a single point. The BACnet standard ANSI/ASHRAE 135 specifies various deployment options for various installations.
- The connector is not specified. The Terminal EL6861 uses a Profibus-compliant 9-pin Sub-D connector.
- The serial network shall be terminated at both ends (default: 120 ohms, tolerance: 5% between the signal wires).
- A minimum of 1, maximum of two network bias resistors shall be installed in every MS/TP network (default: 510 ohms, tolerance: 5%), preferably at the ends of the network. These resistors keep the signal wires at pre-defined signal levels and allow for a better signal detection of the transceivers.
- *Termination and network-bias using the EL6861*: For this terminal the values specified in the Profibus-standard have been implemented: Termination (220 Ohm) and network-bias (620 Ohm) using the optional Profibus-connector. Network-Bias and termination may optionally be switched using the built-in DIP-switch of the Profibus-connector.
- An isolation of at least 1500V is required if connecting devices between buildings. This may be installed using optional segment repeaters w/ built-in isolation

Logical Layer 2

The MS/TP protocol on ISO/OSI layer 2 was exclusively specified for use with BACnet. MS/TP specifies a multi-master / multi-slave serial network. Due to potential collisions only one device is allowed to send to the network simultaneously. The right to send is transferred using a token, which is passed from device to device. After sending to the network a device is obligated to distribute the token to the successor device. To determine the successor all MS/TP devices periodically send a Poll-For-Master request. A positive response identifies the successor device. With this new devices may enter the token-ring or devices not being present anymore are detected and will be excluded from the token-passing.

Master devices are active network participants and may request data from other master- or slave devices (e.g. to read values or to command set-points by writing to others). Slave devices are –by nature- passive and are not allowed to access the network, except they are requested by a master device. In this case they are obligated to respond to the request. Dynamic Device Binding (DM-DDB-A) using a BACnet-broadcast message “Who-Is” cannot be used by slave devices.

The majority of MS/TP devices are master implementations though. Some devices may be configured in both master- and slave mode. Devices which only support slave-mode are rare.

Interface settings

MS/TP uses NRZ (non-return-to-zero), the interface settings are fixed:

- 1 Startbit
- 8 Databits
- 1 Stopbit
- No Parity
- Short form: 8,N,1

Normally these settings are fixed within MS/TP devices and don't need to be modified. Some devices (VFD, pumps, actuators or VAV-boxes), especially those supporting other protocols like Modbus as well, may require to setup the interface parameters as shown above.

All devices within the network shall be configured to use the same speed. Like always for serial communication, the speed is specified in “baud” (baud described the number of characters transmitted per second).

The following baud-rates are specified for BACnet MS/TP:

- 9600 baud*
- 19200 baud
- 38400 baud*
- 57600 baud
- 76800 baud
- 115200 baud

The baud-rates marked with * are required to be supported by all MS/TP devices.

The terminal EL6861 supports all baud-rates specified in the BACnet-standard as shown above.

Device addressing

Every device in a MS/TP network (master or slave) shall be configured using an individual address (MAC address=Media Access Control). The address length is 1 octet and is typically setup using a software tool or DIP-switches. The address shall be unique within the MS/TP network.

Address 0-127 may be used for master devices, where 0-254 may be used for slave devices.

Address 255 specifies the broadcast address (telegrams sent to all devices on the network) and shall not be used as source address. The max. length of telegrams in MS/TP is specified to 501 octet (21 octet network layer header plus 480 octet application layer data).

Specific characteristics when communicating w/ MS/TP devices

The benefit of MS/TP is cheap wiring using long distance connections. But this results in lower transmission speed compared to Ethernet networks. In addition the BACnet implementations of MS/TP devices are often very limited. The majority of devices conforms to the BACnet device profile B-ASC (BACnet Application Specific Controller), not supporting functionality like COV (change of value notifications) as well as ReadPropertyMultiple (reading multiple properties at once). This means communicating to MS/TP devices may require a lot higher reply-times than using Ethernet/IP-connections, especially when requesting larger data portions from devices.

Due to this it is highly recommended to poll only those properties which are required in the application or user representation. Static properties may be requested only once or upon request after it is known that they have changed.

It is recommended to adjust the poll-rates to higher cycle-times to not overload smaller MS/TP devices w/ less resources compared to PLC-controllers.

Routing between MS/TP and BACnet/IP

A device may optionally provide routing capabilities between MS/TP and BACnet/IP. Along with the supplement TS8020 (BACnet/IP) the terminal EL6861 may be optionally configured as a BACnet router. Using multiple EL6861 terminals may setup a multi-channel BACnet-router.

Optimizing the communication

Assigning more bus-access

MS/TP devices which require more access to the network compared to other devices (like BACnet routers to connect different networks) may be assigned a higher number of frames than other devices. The setting „Max_Info_Frames“ in the device object specifies the number of frames the device is allow to send before it has to pass the token. The default value for the terminal EL6861 is specified for 20 Infoframes because the PLC usually requires more bandwidth on the network compared to the devices connected. The default value for all other devices on the network is suggested to equal 1 Infoframe.

Specifying the highest station address

Cyclic „PollForMaster“ telegrams to determine successor devices may cause a heavy bandwidth usage on the network if station addresses are not carefully configured.

Every station address higher than the own station address is required to be requested which leads to unnecessary PollForMaster requests in case of gaps in the addressing. In a perfectly configured network the first device is configured using MAC-address=0 (default value for the terminal EL6861). Further devices should be addressed in ascending order starting with 1, 2, 3 etc. The highest station address used within the network may then be specified in the property MAX_MASTER in the device object of all devices.

Hint: In case some devices do not support writable MAX_MASTER properties (in this case the value is required to equal 127), the terminal EL6861 may be configured using the highest known station address and this setting may be configured in the MAX_MASTER setting of the EL6861 MS/TP configuration.

6 Commissioning

6.1 TwinCAT Quick Start

TwinCAT is a development environment for real-time control including multi-PLC system, NC axis control, programming and operation. The whole system is mapped through this environment and enables access to a programming environment (including compilation) for the controller. Individual digital or analog inputs or outputs can also be read or written directly, in order to verify their functionality, for example.

For further information please refer to <http://infosys.beckhoff.com>:

- **EtherCAT Systemmanual:**
Fieldbus Components → EtherCAT Terminals → EtherCAT System Documentation → Setup in the TwinCAT System Manager
- **TwinCAT 2** → TwinCAT System Manager → I/O - Configuration
- In particular, TwinCAT driver installation:
Fieldbus components → Fieldbus Cards and Switches → FC900x – PCI Cards for Ethernet → Installation

Devices contain the terminals for the actual configuration. All configuration data can be entered directly via editor functions (offline) or via the "Scan" function (online):

- **"offline"**: The configuration can be customized by adding and positioning individual components. These can be selected from a directory and configured.
 - The procedure for offline mode can be found under <http://infosys.beckhoff.com>:
TwinCAT 2 → TwinCAT System Manager → IO - Configuration → Adding an I/O Device
- **"online"**: The existing hardware configuration is read
 - See also <http://infosys.beckhoff.com>:
Fieldbus components → Fieldbus cards and switches → FC900x – PCI Cards for Ethernet → Installation → Searching for devices

The following relationship is envisaged from user PC to the individual control elements:

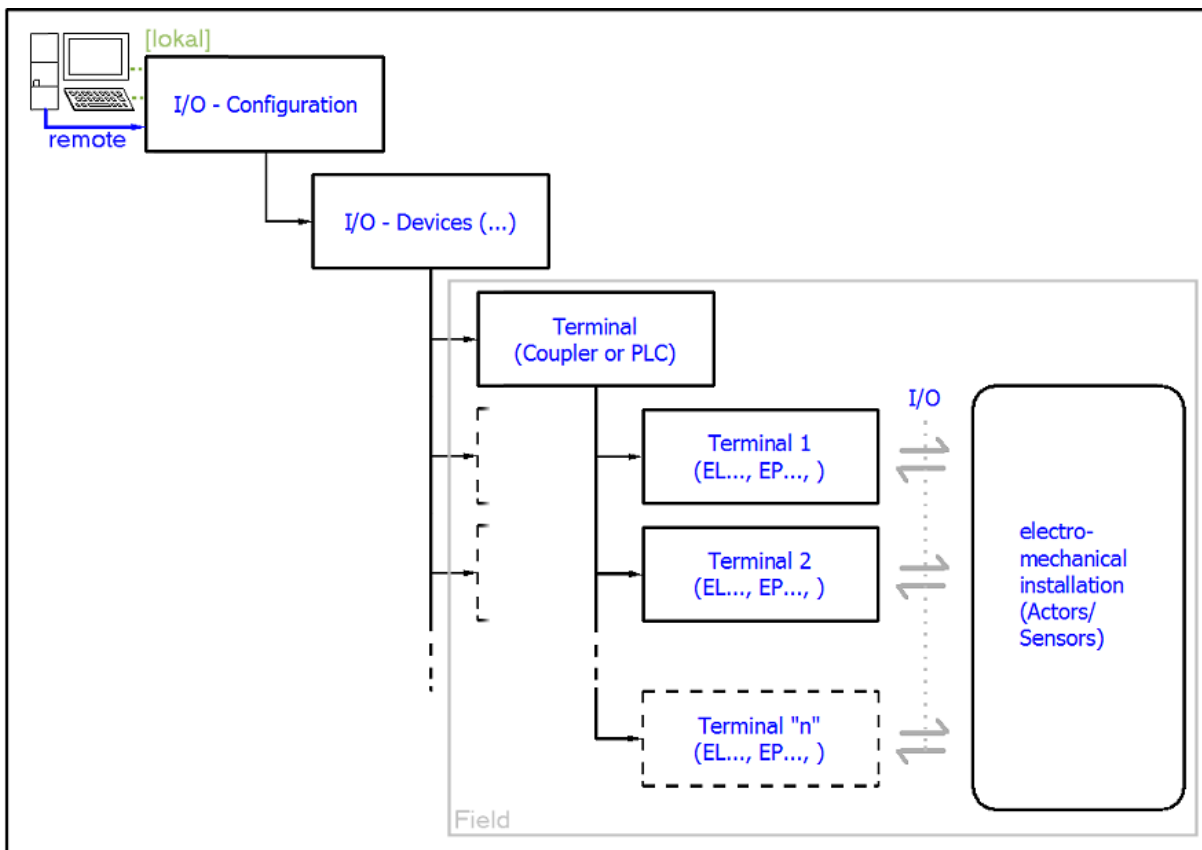

Fig. 26: Relationship between user side (commissioning) and installation

The user inserting of certain components (I/O device, terminal, box...) is the same in TwinCAT 2 and TwinCAT 3. The descriptions below relate to the online procedure.

Sample configuration (actual configuration)

Based on the following sample configuration, the subsequent subsections describe the procedure for TwinCAT 2 and TwinCAT 3:

- Control system (PLC) **CX2040** including **CX2100-0004** power supply unit
- Connected to the CX2040 on the right (E-bus):
EL1004 (4-channel analog input terminal -10...+10 V)
- Linked via the X001 port (RJ-45): **EK1100** EtherCAT Coupler
- Connected to the EK1100 EtherCAT coupler on the right (E-bus):
EL2008 (8-channel digital output terminal 24 V DC; 0.5 A)
- (Optional via X000: a link to an external PC for the user interface)

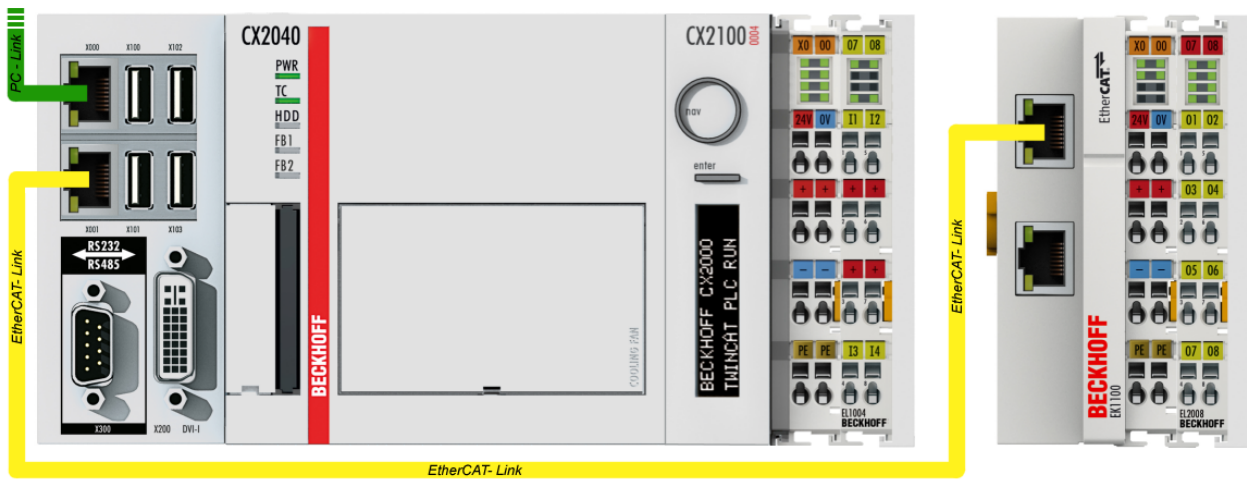

Fig. 27: Control configuration with Embedded PC, input (EL1004) and output (EL2008)

Note that all combinations of a configuration are possible; for example, the EL1004 terminal could also be connected after the coupler, or the EL2008 terminal could additionally be connected to the CX2040 on the right, in which case the EK1100 coupler wouldn't be necessary.

6.1.1 TwinCAT 2

Startup

TwinCAT basically uses two user interfaces: the TwinCAT System Manager for communication with the electromechanical components and TwinCAT PLC Control for the development and compilation of a controller. The starting point is the TwinCAT System Manager.

After successful installation of the TwinCAT system on the PC to be used for development, the TwinCAT 2 System Manager displays the following user interface after startup:

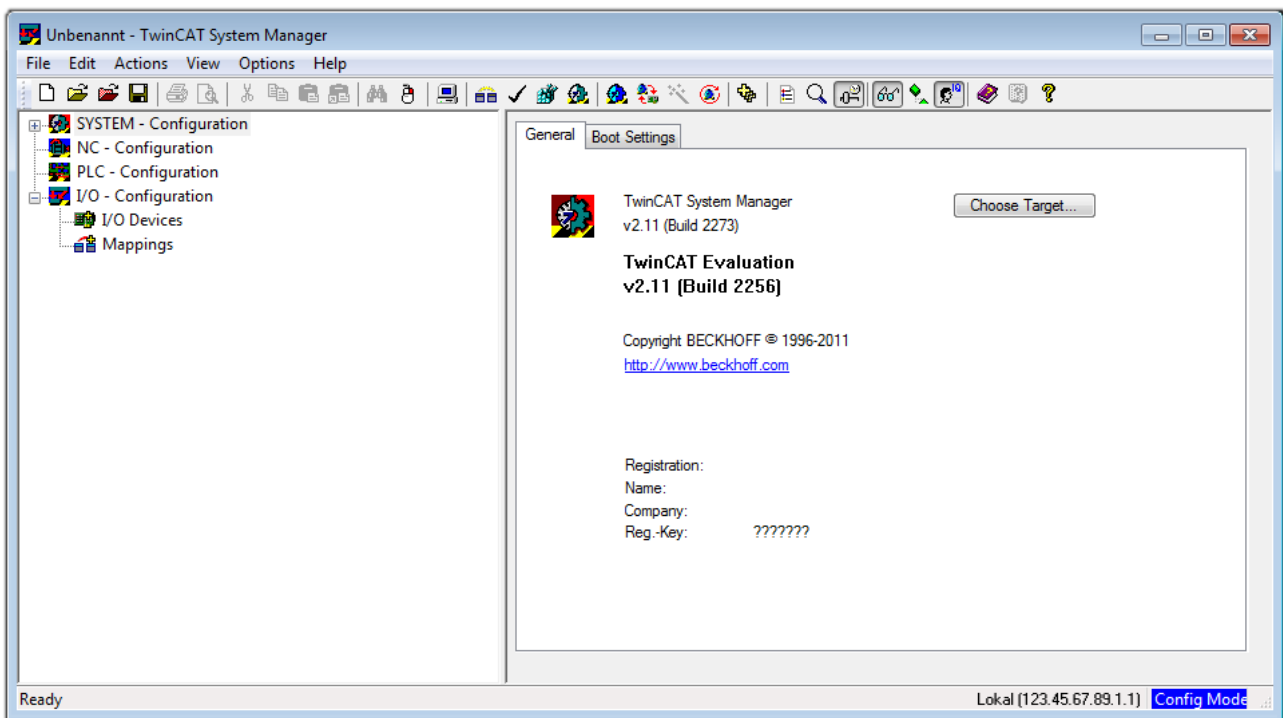



Fig. 28: Initial TwinCAT 2 user interface

Generally, TwinCAT can be used in local or remote mode. Once the TwinCAT system including the user interface (standard) is installed on the respective PLC, TwinCAT can be used in local mode and thereby the next step is "Insert Device [▶ 39]".

If the intention is to address the TwinCAT runtime environment installed on a PLC as development environment remotely from another system, the target system must be made known first. In the menu under

"Actions" → "Choose Target System...", via the symbol  " or the "F8" key, open the following window:

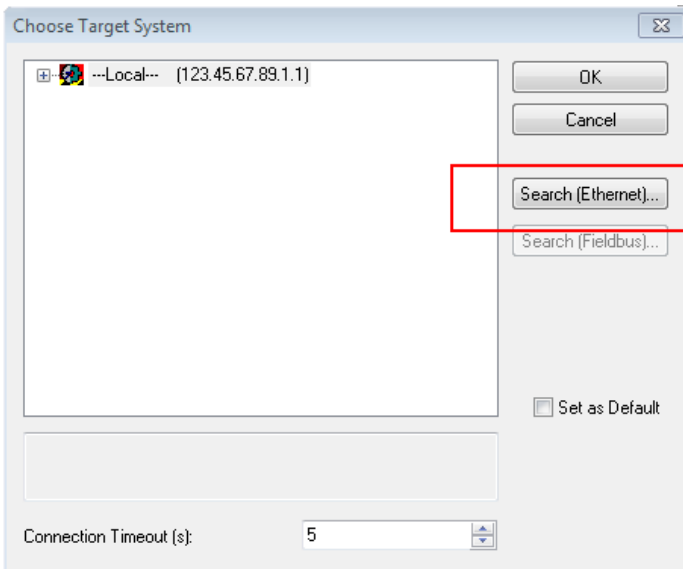

Fig. 29: Selection of the target system

Use "Search (Ethernet)..." to enter the target system. Thus a next dialog opens to either:

- enter the known computer name after "Enter Host Name / IP:" (as shown in red)
- perform a "Broadcast Search" (if the exact computer name is not known)
- enter the known computer IP or AmsNetID.

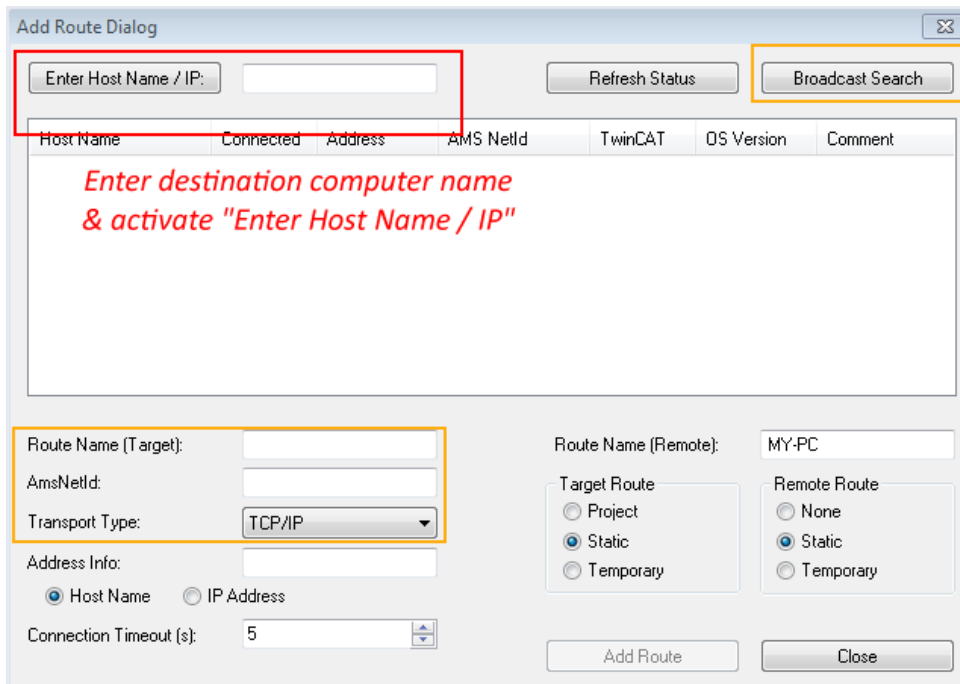
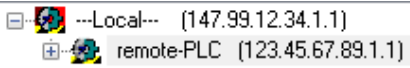

Fig. 30: Specify the PLC for access by the TwinCAT System Manager: selection of the target system



Once the target system has been entered, it is available for selection as follows (a password may have to be entered):



After confirmation with "OK" the target system can be accessed via the System Manager.

Adding devices

In the configuration tree of the TwinCAT 2 System Manager user interface on the left, select "I/O Devices" and then right-click to open a context menu and select "Scan Devices...", or start the action in the menu bar

via . The TwinCAT System Manager may first have to be set to "Config mode" via  or via menu "Actions" → "Set/Reset TwinCAT to Config Mode..." (Shift + F4).

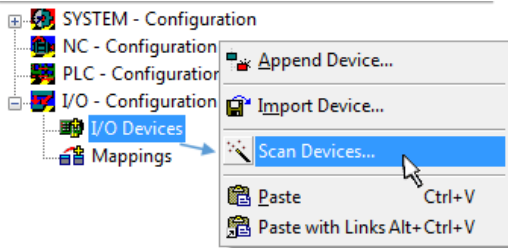

Fig. 31: Select "Scan Devices..."

Confirm the warning message, which follows, and select "EtherCAT" in the dialog:

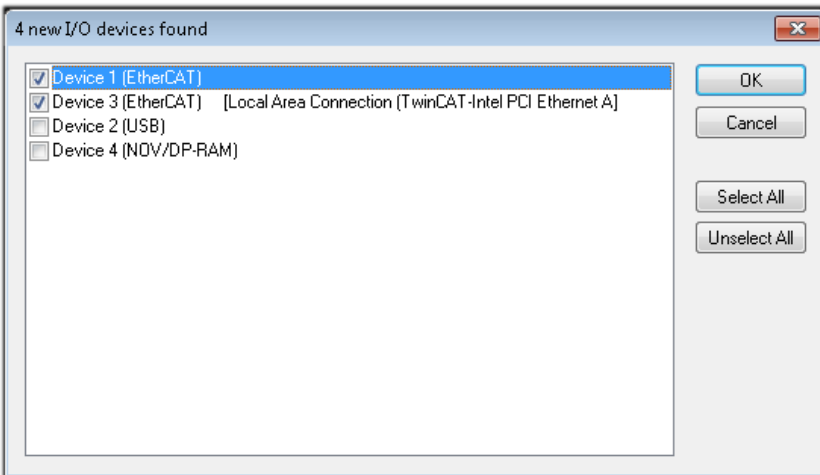

Fig. 32: Automatic detection of I/O devices: selection the devices to be integrated

Confirm the message "Find new boxes", in order to determine the terminals connected to the devices. "Free Run" enables manipulation of input and output values in "Config mode" and should also be acknowledged.

Based on the [sample configuration](#) [▶ 36] described at the beginning of this section, the result is as follows:

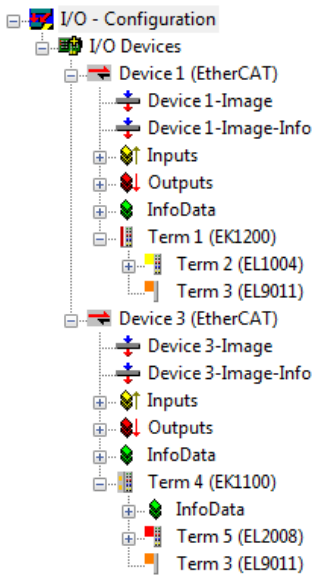

Fig. 33: Mapping of the configuration in the TwinCAT 2 System Manager

The whole process consists of two stages, which may be performed separately (first determine the devices, then determine the connected elements such as boxes, terminals, etc.). A scan can also be initiated by selecting "Device ..." from the context menu, which then reads the elements present in the configuration below:

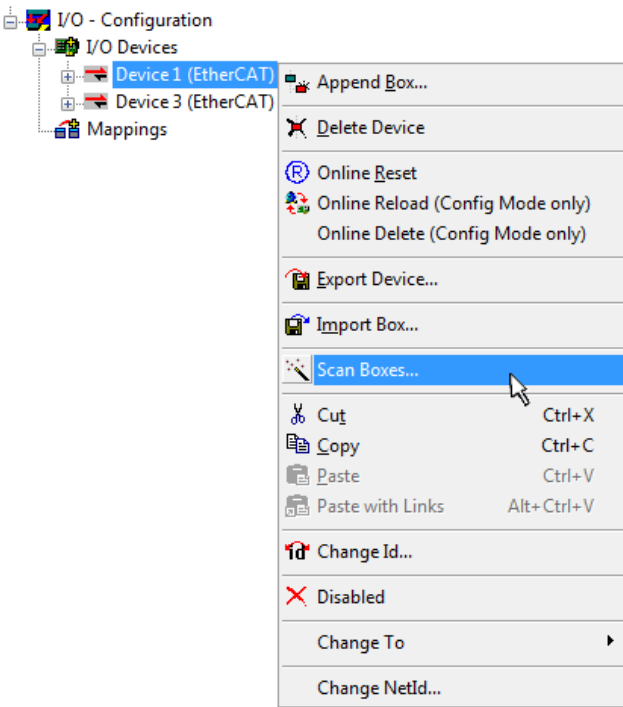

Fig. 34: Reading of individual terminals connected to a device

This functionality is useful if the actual configuration is modified at short notice.

Programming and integrating the PLC

TwinCAT PLC Control is the development environment for the creation of the controller in different program environments: TwinCAT PLC Control supports all languages described in IEC 61131-3. There are two text-based languages and three graphical languages.

- **Text-based languages**
 - Instruction List (IL)
 - Structured Text (ST)

- **Graphical languages**
 - Function Block Diagram (FBD)
 - Ladder Diagram (LD)
 - The Continuous Function Chart Editor (CFC)
 - Sequential Function Chart (SFC)

The following section refers to Structured Text (ST).

After starting TwinCAT PLC Control, the following user interface is shown for an initial project:

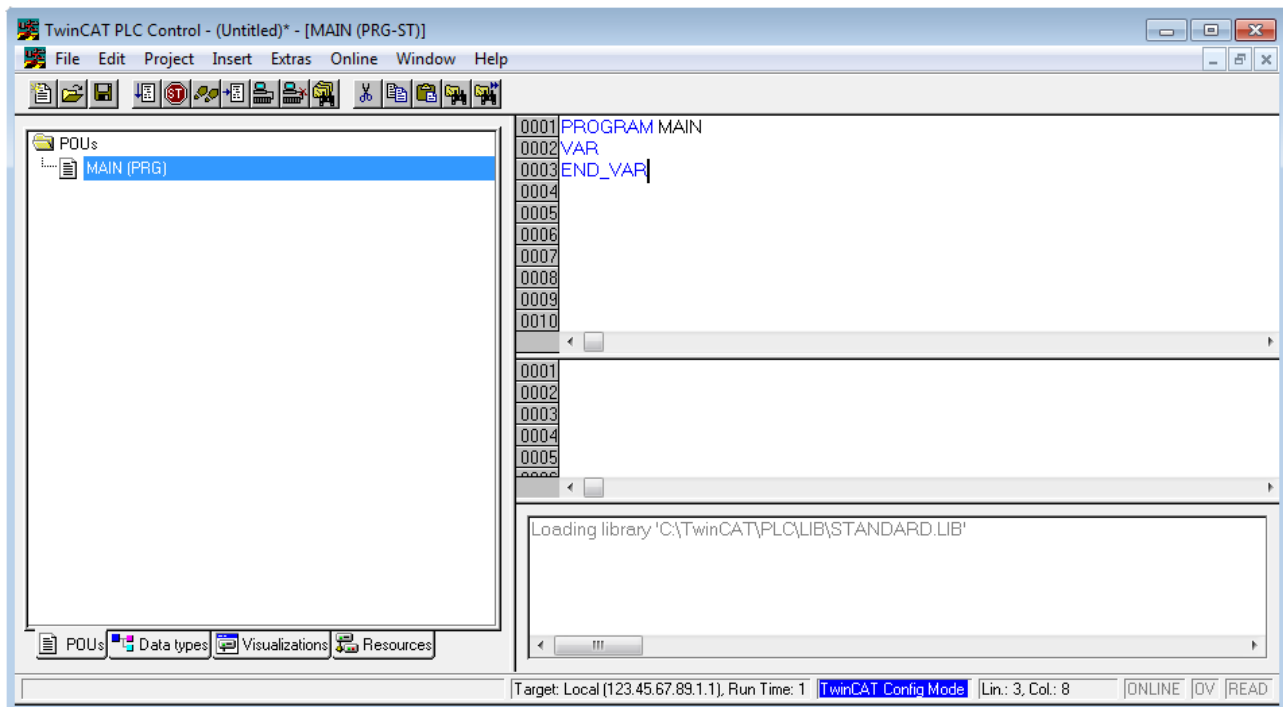

Fig. 35: TwinCAT PLC Control after startup

Sample variables and a sample program have been created and stored under the name "PLC_example.pro":

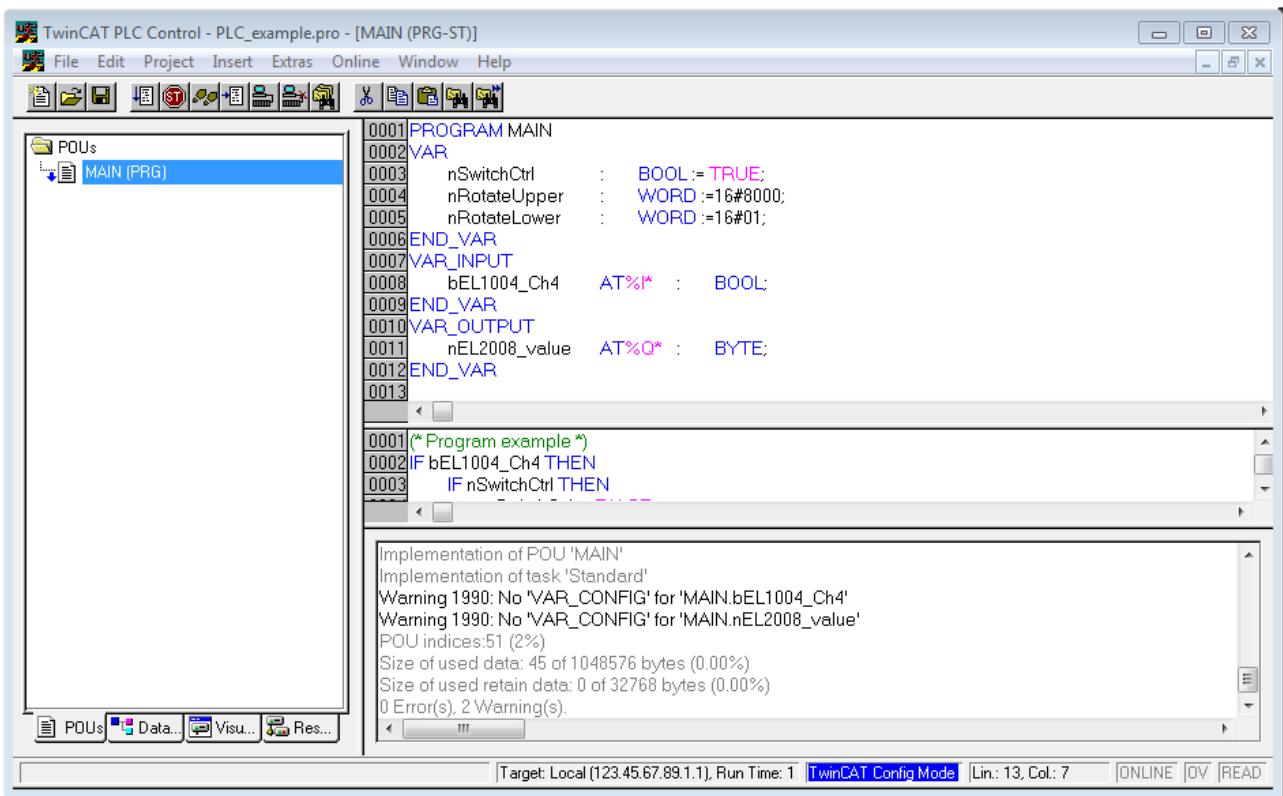

Fig. 36: Sample program with variables after a compile process (without variable integration)

Warning 1990 (missing "VAR_CONFIG") after a compile process indicates that the variables defined as external (with the ID "AT%I*" or "AT%Q*") have not been assigned. After successful compilation, TwinCAT PLC Control creates a ".tpy" file in the directory in which the project was stored. This file (.tpy) contains variable assignments and is not known to the System Manager, hence the warning. Once the System Manager has been notified, the warning no longer appears.

First, integrate the TwinCAT PLC Control project in the **System Manager** via the context menu of the PLC configuration; right-click and select "Append PLC Project...":

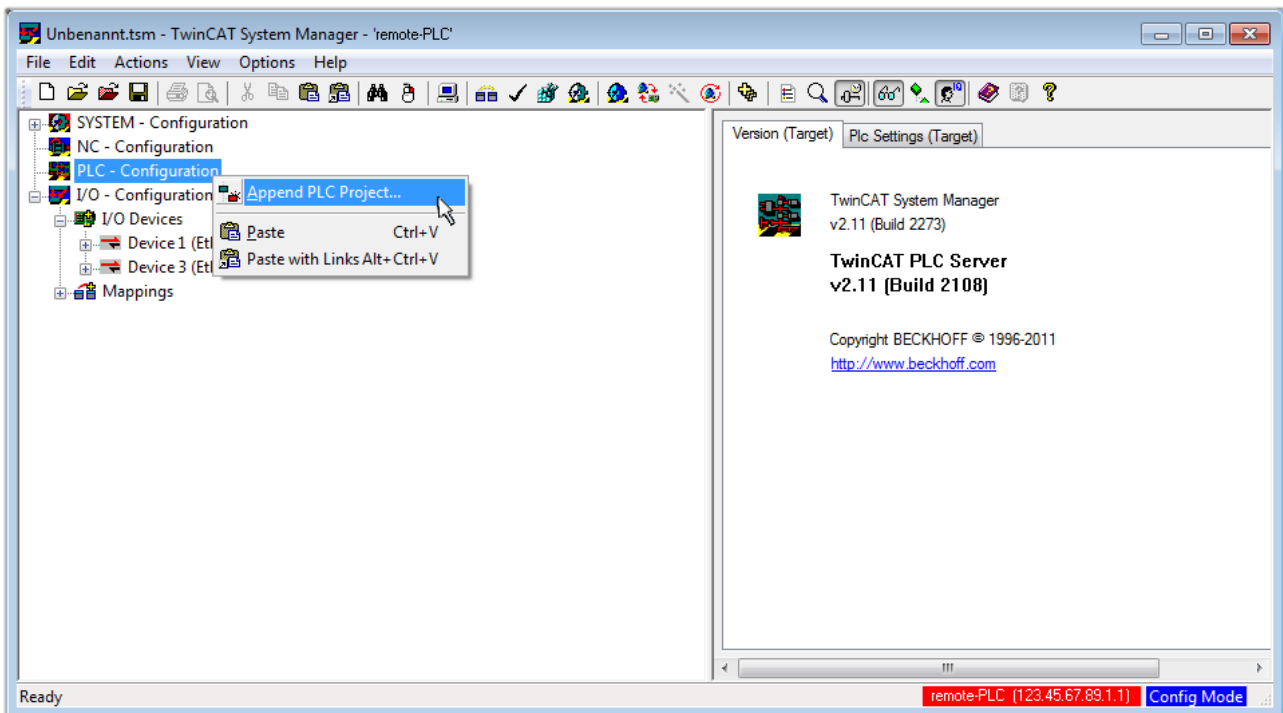

Fig. 37: Appending the TwinCAT PLC Control project

Select the PLC configuration "PLC_example.tpy" in the browser window that opens. The project including the two variables identified with "AT" are then integrated in the configuration tree of the System Manager:

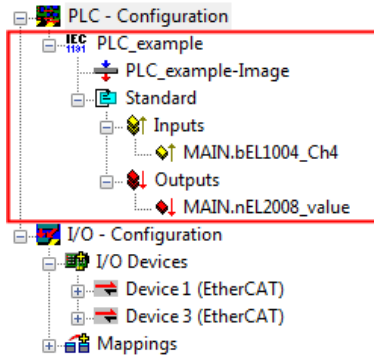

Fig. 38: PLC project integrated in the PLC configuration of the System Manager

The two variables "bEL1004_Ch4" and "nEL2008_value" can now be assigned to certain process objects of the I/O configuration.

Assigning variables

Open a window for selecting a suitable process object (PDO) via the context menu of a variable of the integrated project "PLC_example" and via "Modify Link..." "Standard":

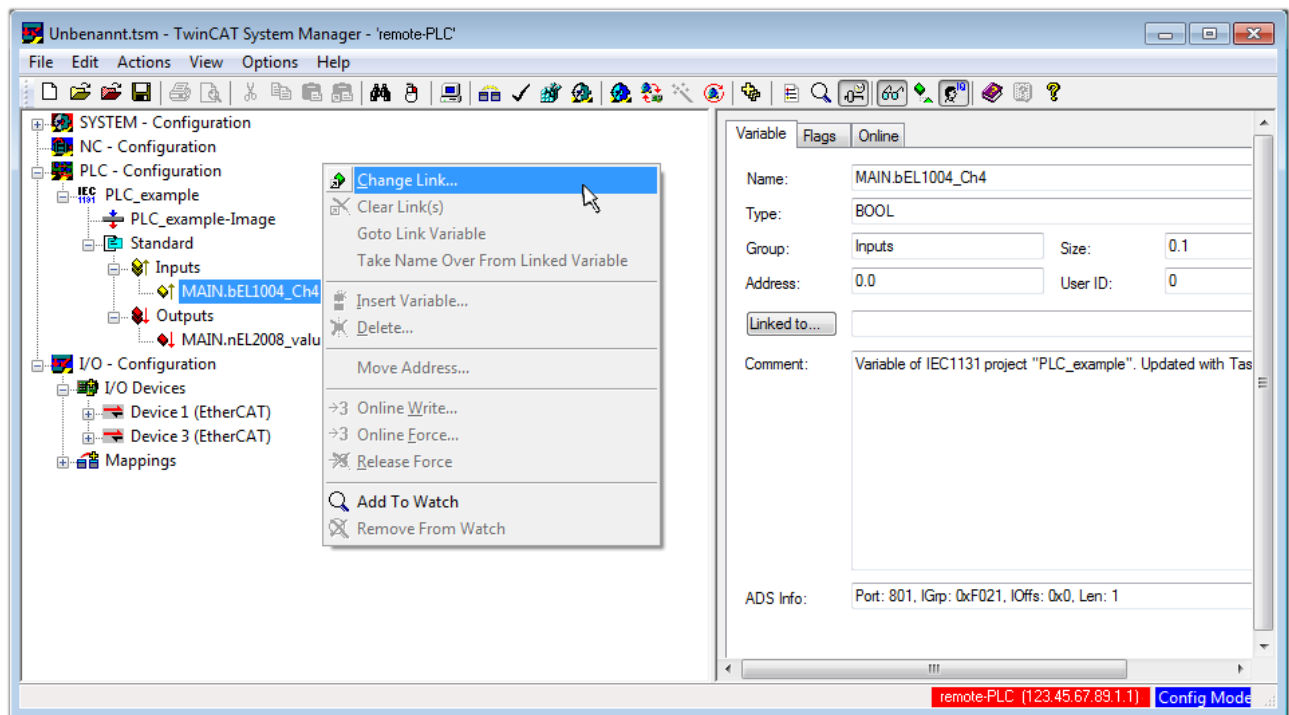

Fig. 39: Creating the links between PLC variables and process objects

In the window that opens, the process object for the variable "bEL1004_Ch4" of type BOOL can be selected from the PLC configuration tree:

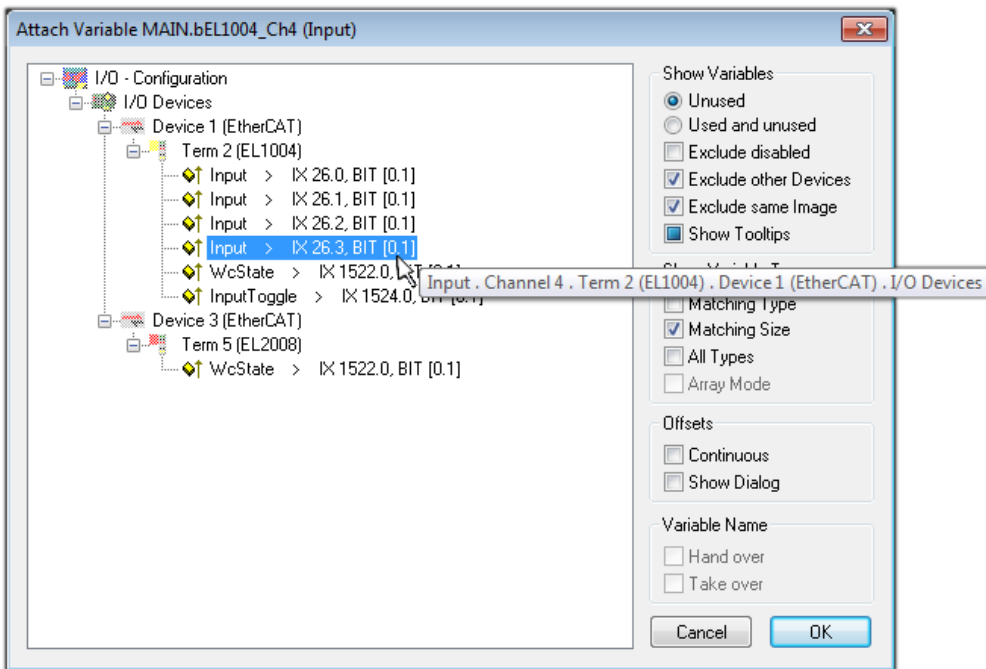

Fig. 40: Selecting PDO of type BOOL

According to the default setting, certain PDO objects are now available for selection. In this sample the input of channel 4 of the EL1004 terminal is selected for linking. In contrast, the checkbox "All types" must be ticked for creating the link for the output variables, in order to allocate a set of eight separate output bits to a byte variable. The following diagram shows the whole process:

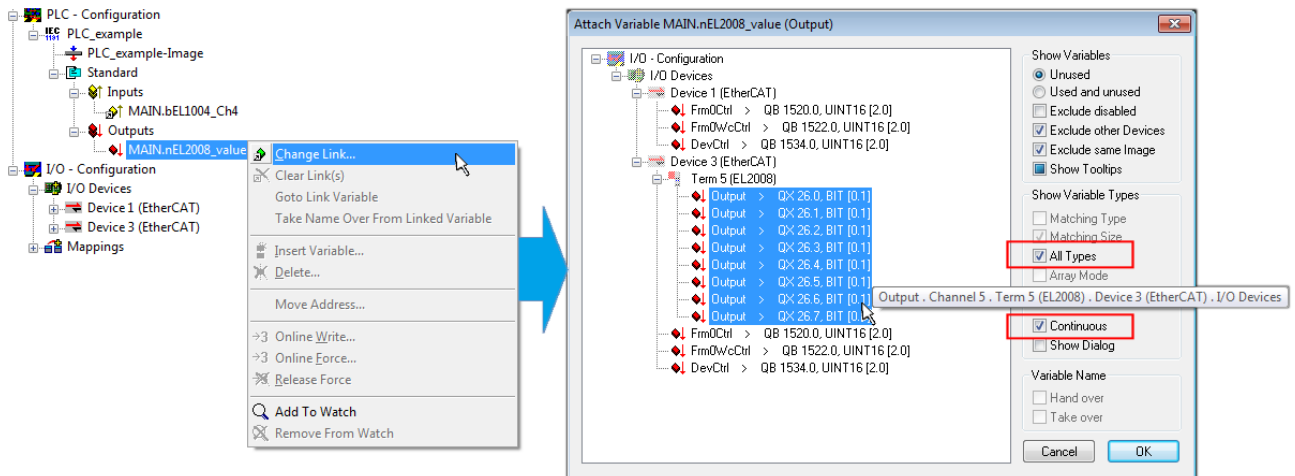



Fig. 41: Selecting several PDOs simultaneously: activate "Continuous" and "All types"

Note that the "Continuous" checkbox was also activated. This is designed to allocate the bits contained in the byte of the variable "nEL2008_value" sequentially to all eight selected output bits of the EL2008 terminal. In this way it is possible to subsequently address all eight outputs of the terminal in the program with a byte corresponding to bit 0 for channel 1 to bit 7 for channel 8 of the PLC. A special symbol () at the yellow or red object of the variable indicates that a link exists. The links can also be checked by selecting a "Goto Link Variable" from the context menu of a variable. The object opposite, in this case the PDO, is automatically selected:

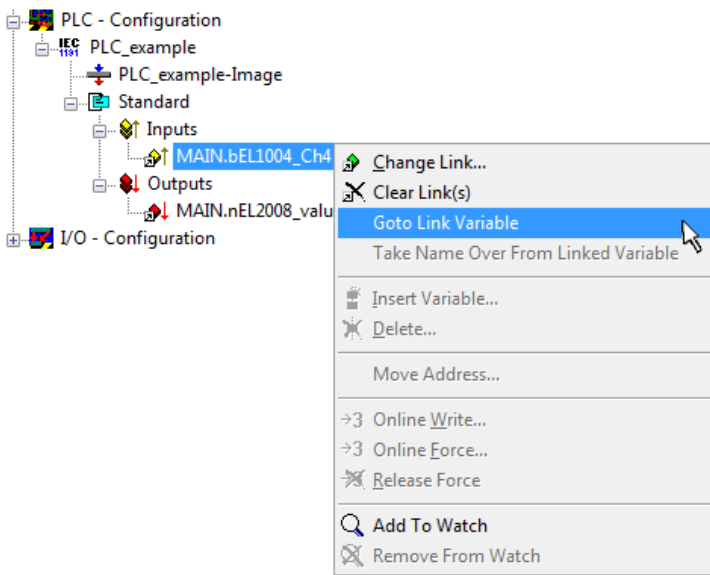

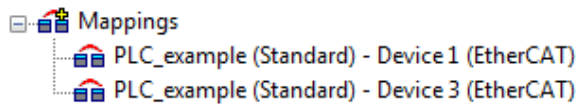

Fig. 42: Application of a "Goto Link" variable, using "MAIN.bEL1004_Ch4" as a sample

The process of assigning variables to the PDO is completed via the menu selection "Actions" → "Generate Mappings", key Ctrl+M or by clicking on the symbol  in the menu.

This can be visualized in the configuration:



The process of creating links can also take place in the opposite direction, i.e. starting with individual PDOs to variable. However, in this example it would then not be possible to select all output bits for the EL2008, since the terminal only makes individual digital outputs available. If a terminal has a byte, word, integer or similar PDO, it is possible to allocate this a set of bit-standardised variables (type "BOOL"). Here, too, a "Goto Link Variable" from the context menu of a PDO can be executed in the other direction, so that the respective PLC instance can then be selected.

Activation of the configuration

The allocation of PDO to PLC variables has now established the connection from the controller to the inputs and outputs of the terminals. The configuration can now be activated. First, the configuration can be verified

via  (or via "Actions" → "Check Configuration"). If no error is present, the configuration can be

activated via  (or via "Actions" → "Activate Configuration...") to transfer the System Manager settings to the runtime system. Confirm the messages "Old configurations are overwritten!" and "Restart TwinCAT system in Run mode" with "OK".

A few seconds later the real-time status **RTime 0%** is displayed at the bottom right in the System Manager. The PLC system can then be started as described below.

Starting the controller

Starting from a remote system, the PLC control has to be linked with the Embedded PC over Ethernet via "Online" → "Choose Run-Time System...":

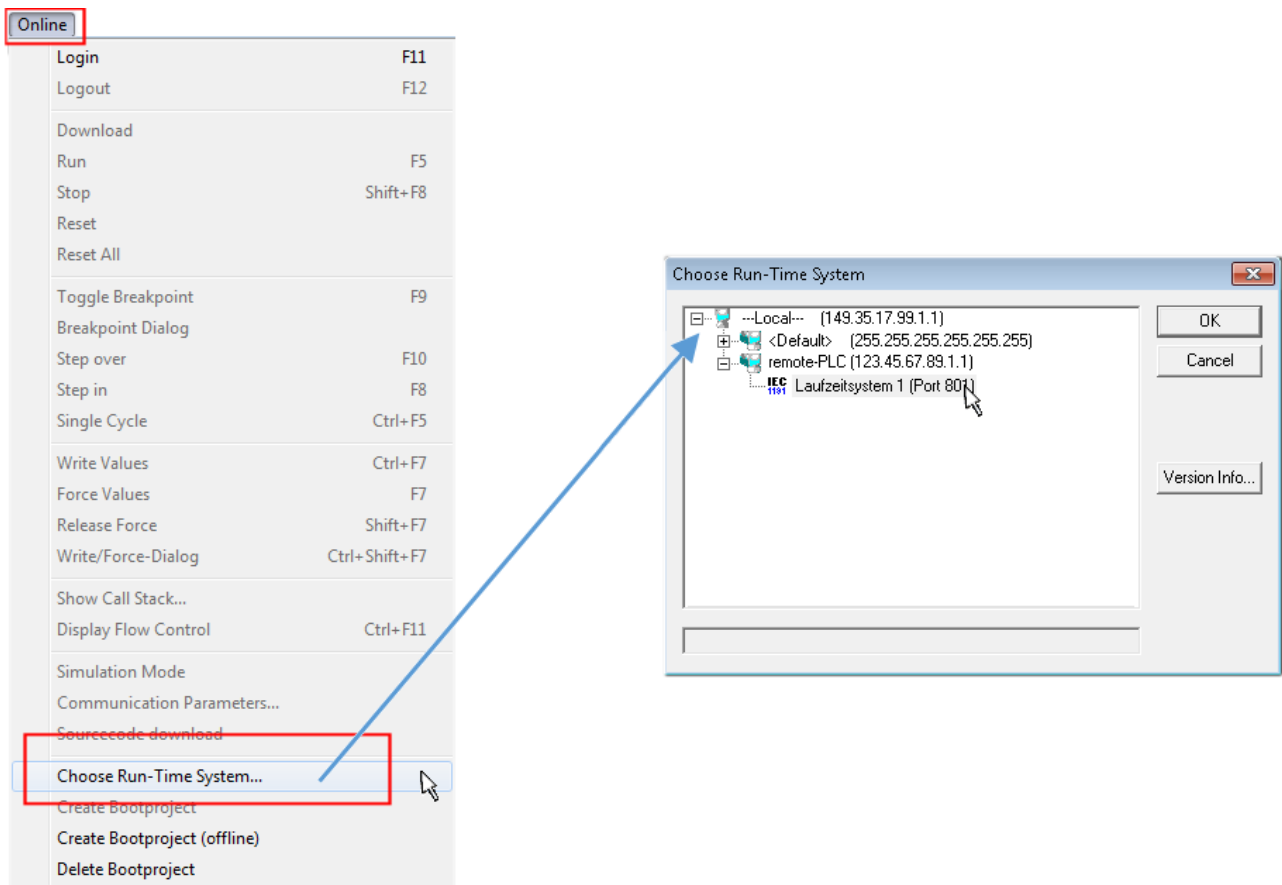



Fig. 43: Choose target system (remote)

In this sample "Runtime system 1 (port 801)" is selected and confirmed. Link the PLC with the real-time

system via menu option "Online" → "Login", the F11 key or by clicking on the symbol . The control program can then be loaded for execution. This results in the message "No program on the controller! Should the new program be loaded?", which should be acknowledged with "Yes". The runtime environment is ready for the program start:

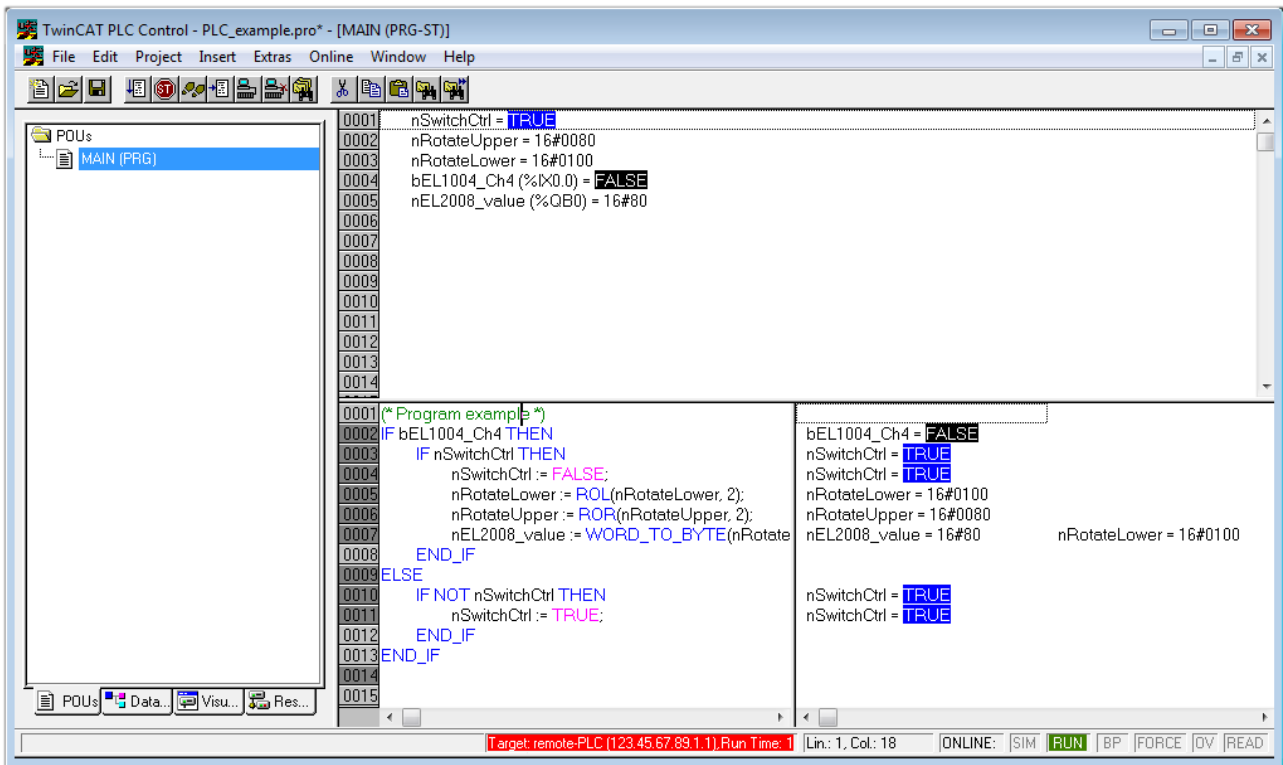

Fig. 44: PLC Control logged in, ready for program startup

The PLC can now be started via "Online" → "Run", F5 key or .

6.1.2 TwinCAT 3

Startup

TwinCAT makes the development environment areas available together with Microsoft Visual Studio: after startup, the project folder explorer appears on the left in the general window area (cf. "TwinCAT System Manager" of TwinCAT 2) for communication with the electromechanical components.

After successful installation of the TwinCAT system on the PC to be used for development, TwinCAT 3 (shell) displays the following user interface after startup:

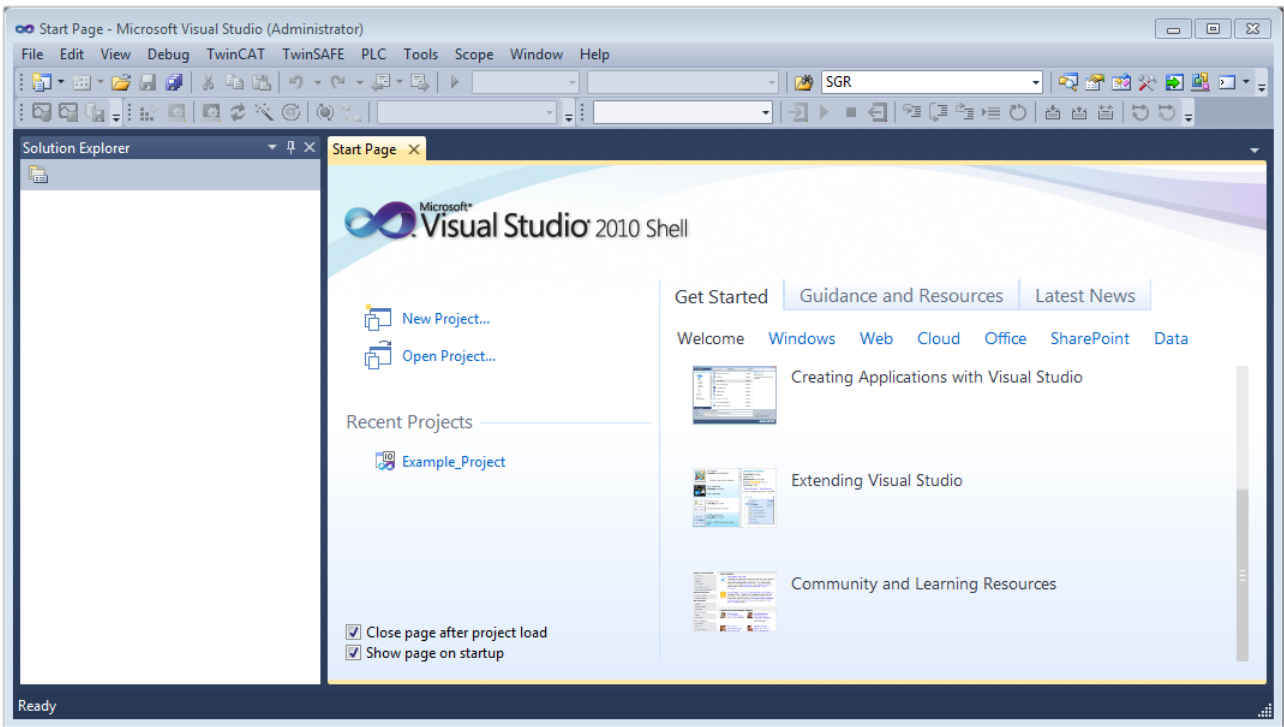



Fig. 45: Initial TwinCAT 3 user interface

First create a new project via  **New TwinCAT Project...** (or under "File"→"New"→"Project..."). In the following dialog make the corresponding entries as required (as shown in the diagram):

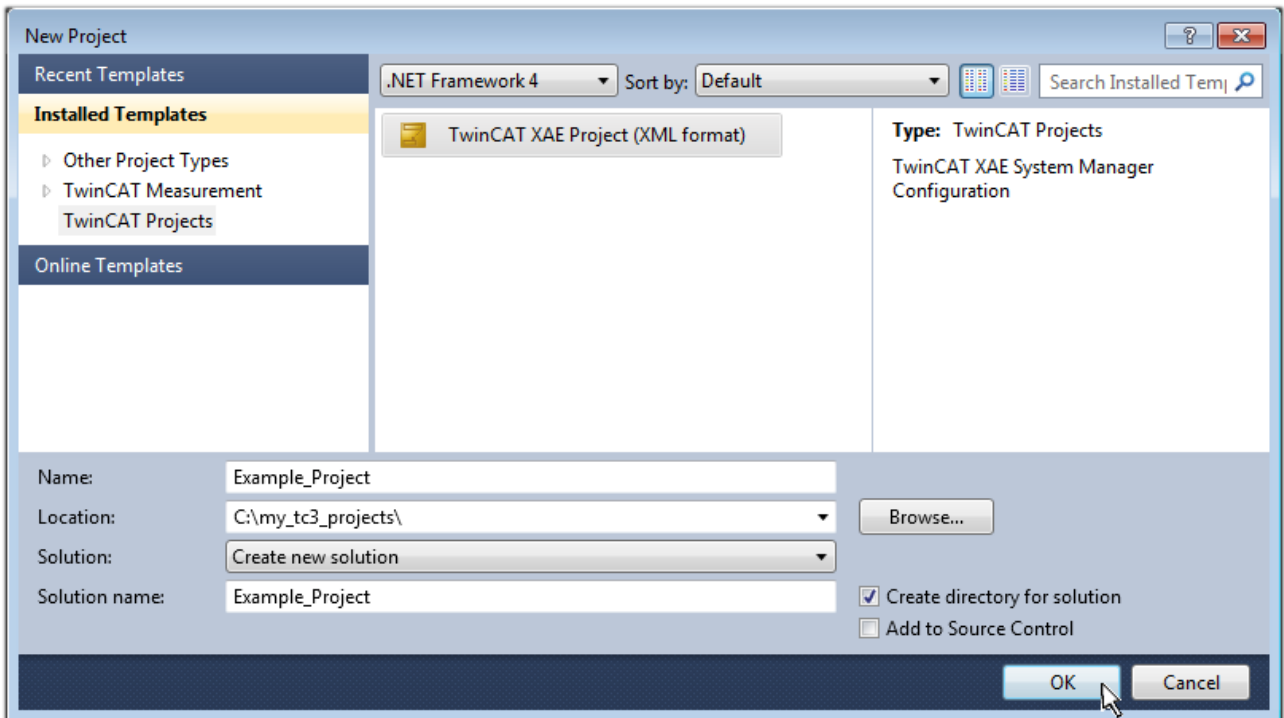

Fig. 46: Create new TwinCAT project

The new project is then available in the project folder explorer:

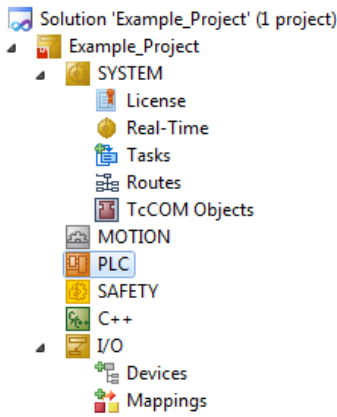
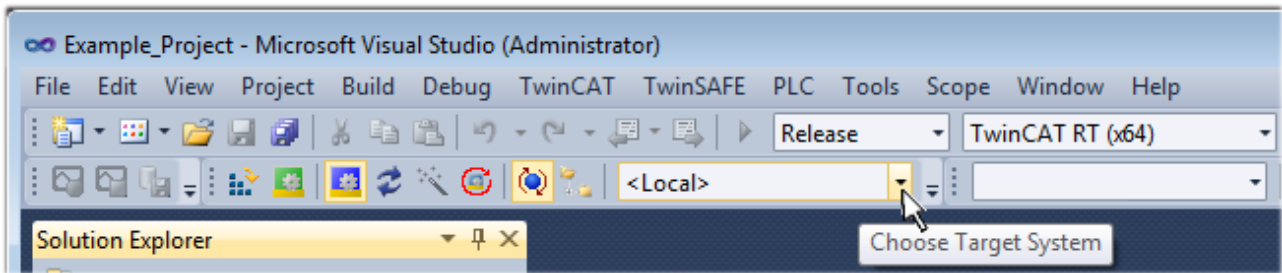

Fig. 47: New TwinCAT3 project in the project folder explorer

Generally, TwinCAT can be used in local or remote mode. Once the TwinCAT system including the user interface (standard) is installed on the respective PLC, TwinCAT can be used in local mode and thereby the next step is "Insert Device [▶ 50]".

If the intention is to address the TwinCAT runtime environment installed on a PLC as development environment remotely from another system, the target system must be made known first. Via the symbol in the menu bar:



expand the pull-down menu:

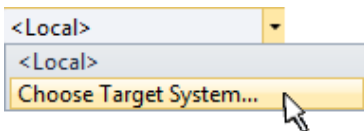

and open the following window:

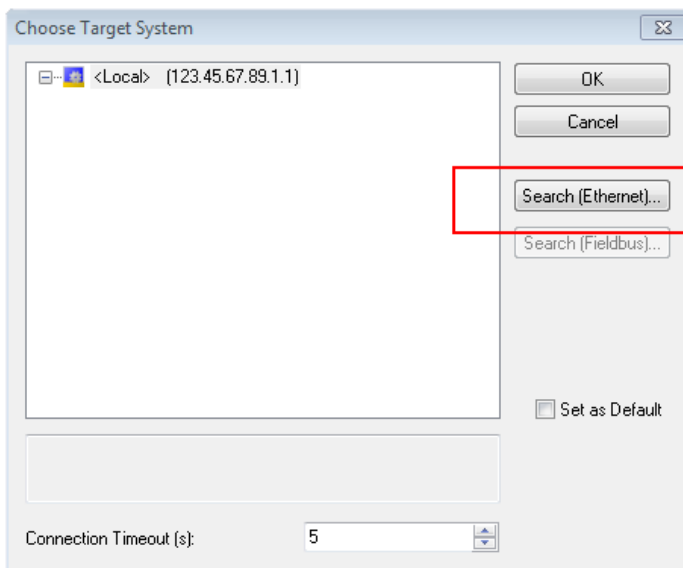

Fig. 48: Selection dialog: Choose the target system

Use "Search (Ethernet)..." to enter the target system. Thus a next dialog opens to either:

- enter the known computer name after "Enter Host Name / IP:" (as shown in red)
- perform a "Broadcast Search" (if the exact computer name is not known)
- enter the known computer IP or AmsNetID.

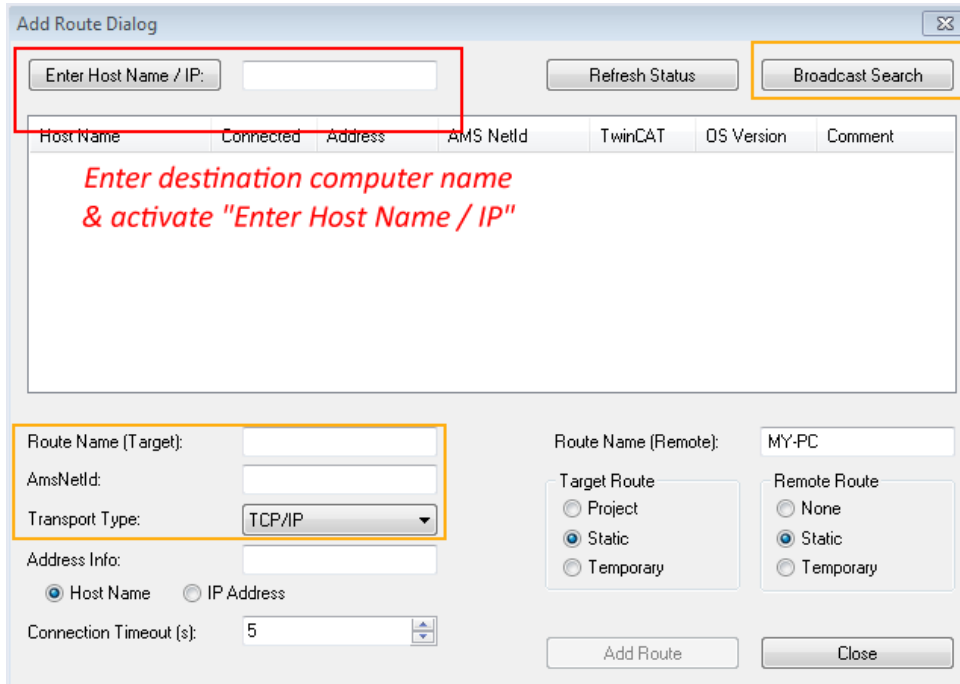
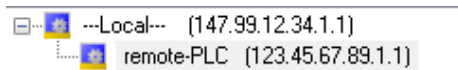

Fig. 49: Specify the PLC for access by the TwinCAT System Manager: selection of the target system

Once the target system has been entered, it is available for selection as follows (a password may have to be entered):



After confirmation with "OK" the target system can be accessed via the Visual Studio shell.

Adding devices

In the project folder explorer of the Visual Studio shell user interface on the left, select "Devices" within

element "I/O", then right-click to open a context menu and select "Scan" or start the action via  in the

menu bar. The TwinCAT System Manager may first have to be set to "Config mode" via  or via the menu "TwinCAT" → "Restart TwinCAT (Config mode)".

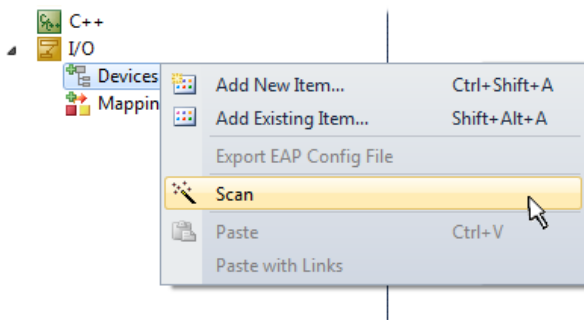

Fig. 50: Select "Scan"

Confirm the warning message, which follows, and select "EtherCAT" in the dialog:

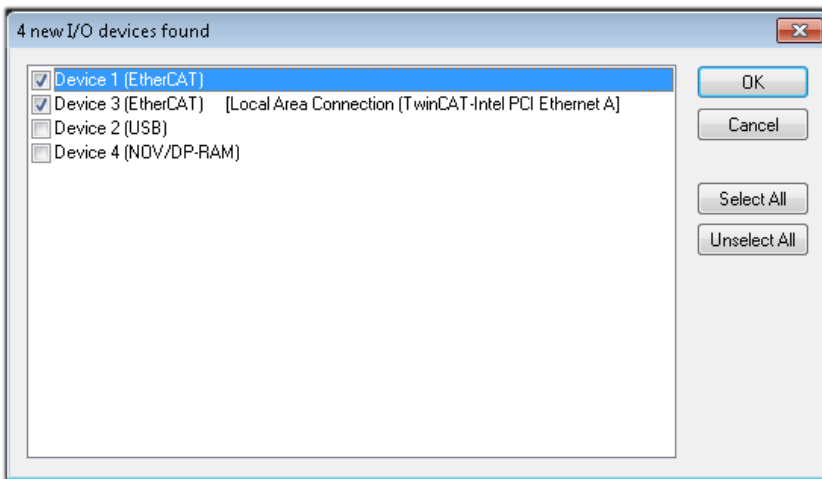

Fig. 51: Automatic detection of I/O devices: selection the devices to be integrated

Confirm the message "Find new boxes", in order to determine the terminals connected to the devices. "Free Run" enables manipulation of input and output values in "Config mode" and should also be acknowledged.

Based on the [sample configuration \[▶_36\]](#) described at the beginning of this section, the result is as follows:

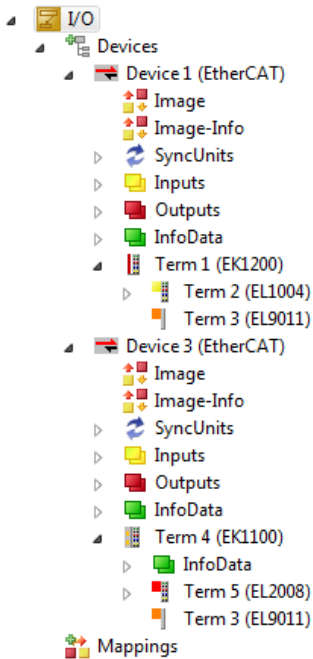

Fig. 52: Mapping of the configuration in VS shell of the TwinCAT3 environment

The whole process consists of two stages, which may be performed separately (first determine the devices, then determine the connected elements such as boxes, terminals, etc.). A scan can also be initiated by selecting "Device ..." from the context menu, which then reads the elements present in the configuration below:

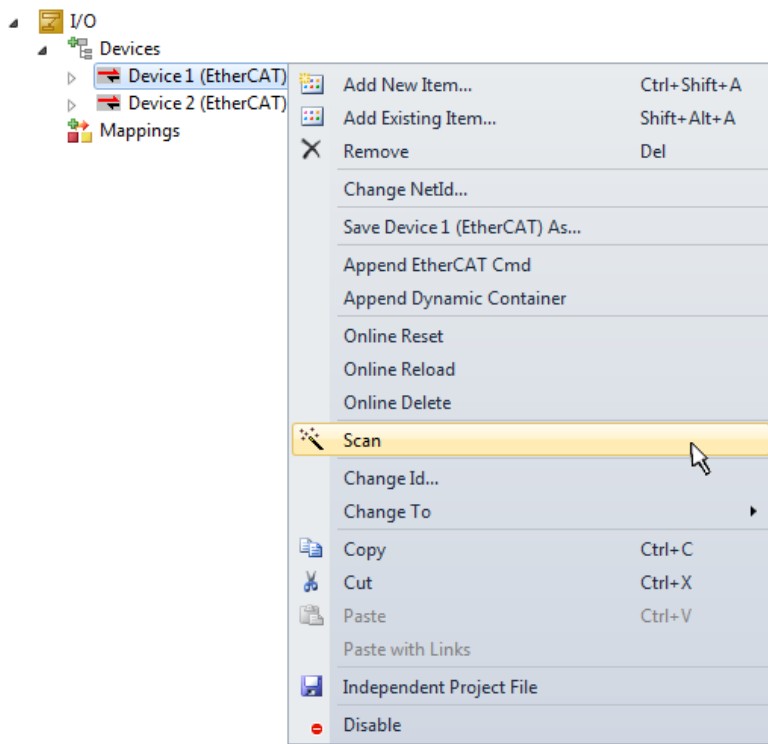

Fig. 53: Reading of individual terminals connected to a device

This functionality is useful if the actual configuration is modified at short notice.

Programming the PLC

TwinCAT PLC Control is the development environment for the creation of the controller in different program environments: TwinCAT PLC Control supports all languages described in IEC 61131-3. There are two text-based languages and three graphical languages.

- **Text-based languages**
 - Instruction List (IL)
 - Structured Text (ST)
- **Graphical languages**
 - Function Block Diagram (FBD)
 - Ladder Diagram (LD)
 - The Continuous Function Chart Editor (CFC)
 - Sequential Function Chart (SFC)

The following section refers to Structured Text (ST).

In order to create a programming environment, a PLC subproject is added to the project sample via the context menu of "PLC" in the project folder explorer by selecting "Add New Item....":

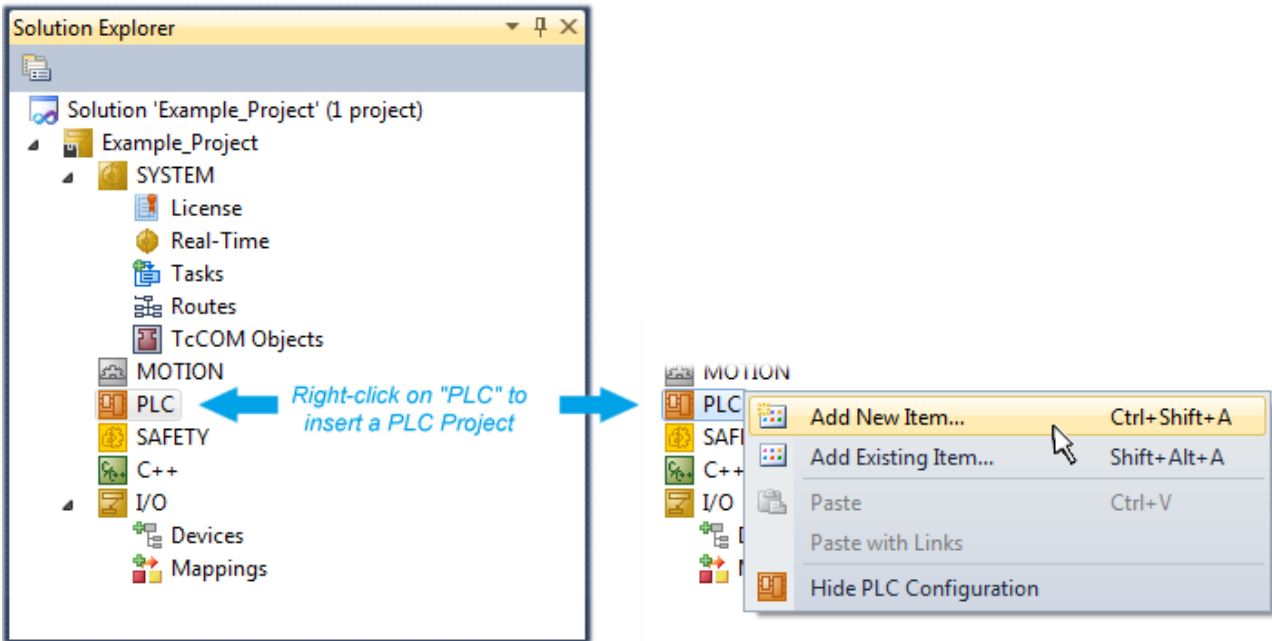

Fig. 54: Adding the programming environment in "PLC"

In the dialog that opens select "Standard PLC project" and enter "PLC_example" as project name, for example, and select a corresponding directory:

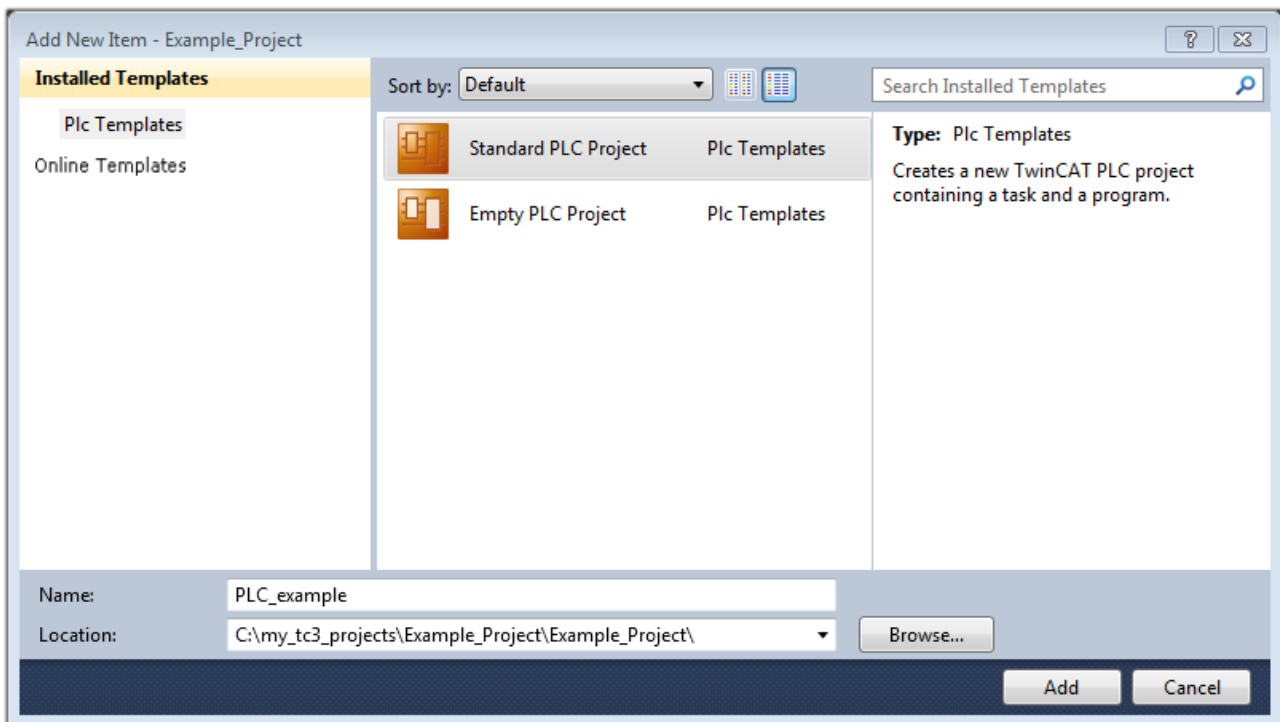

Fig. 55: Specifying the name and directory for the PLC programming environment

The "Main" program, which already exists by selecting "Standard PLC project", can be opened by double-clicking on "PLC_example_project" in "POUs". The following user interface is shown for an initial project:

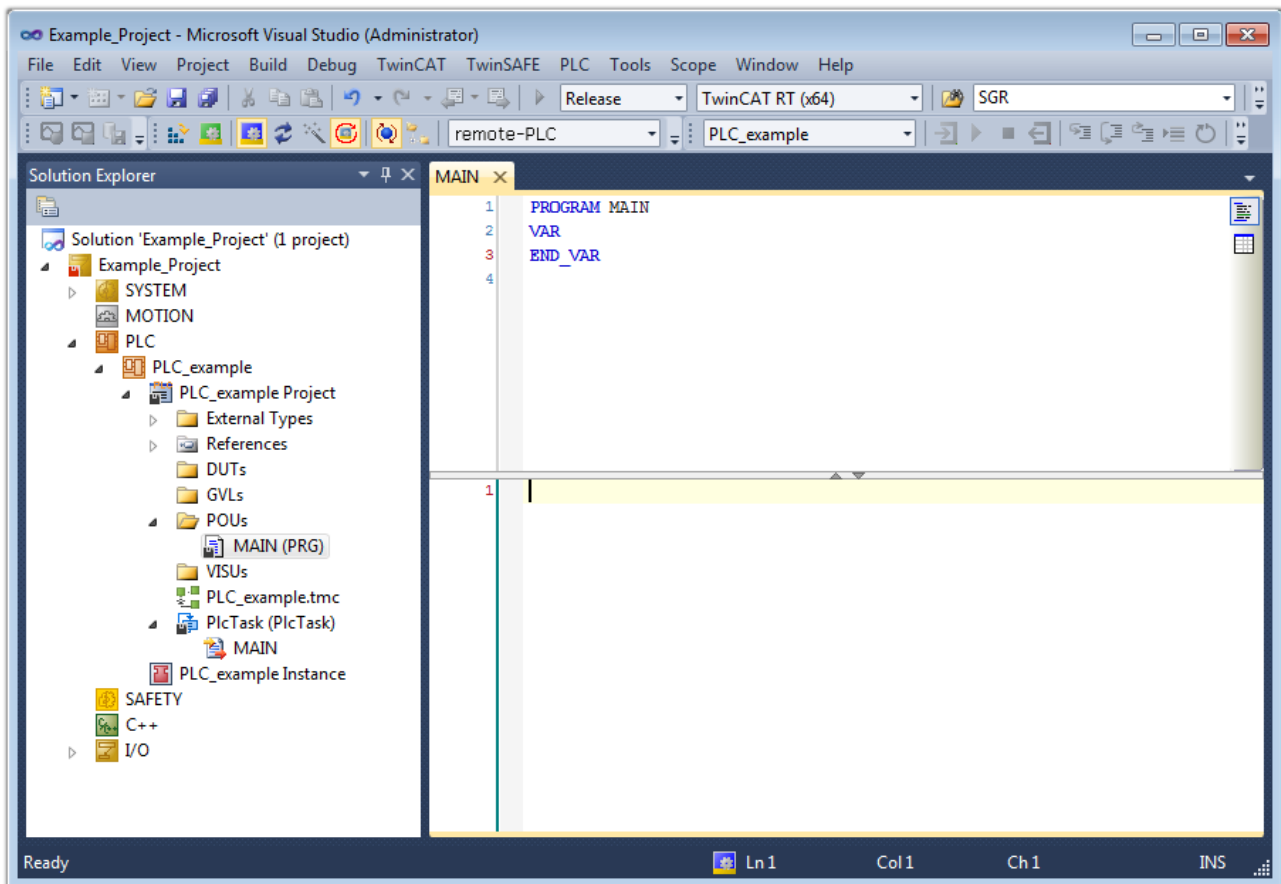

Fig. 56: Initial "Main" program of the standard PLC project

To continue, sample variables and a sample program have now been created:

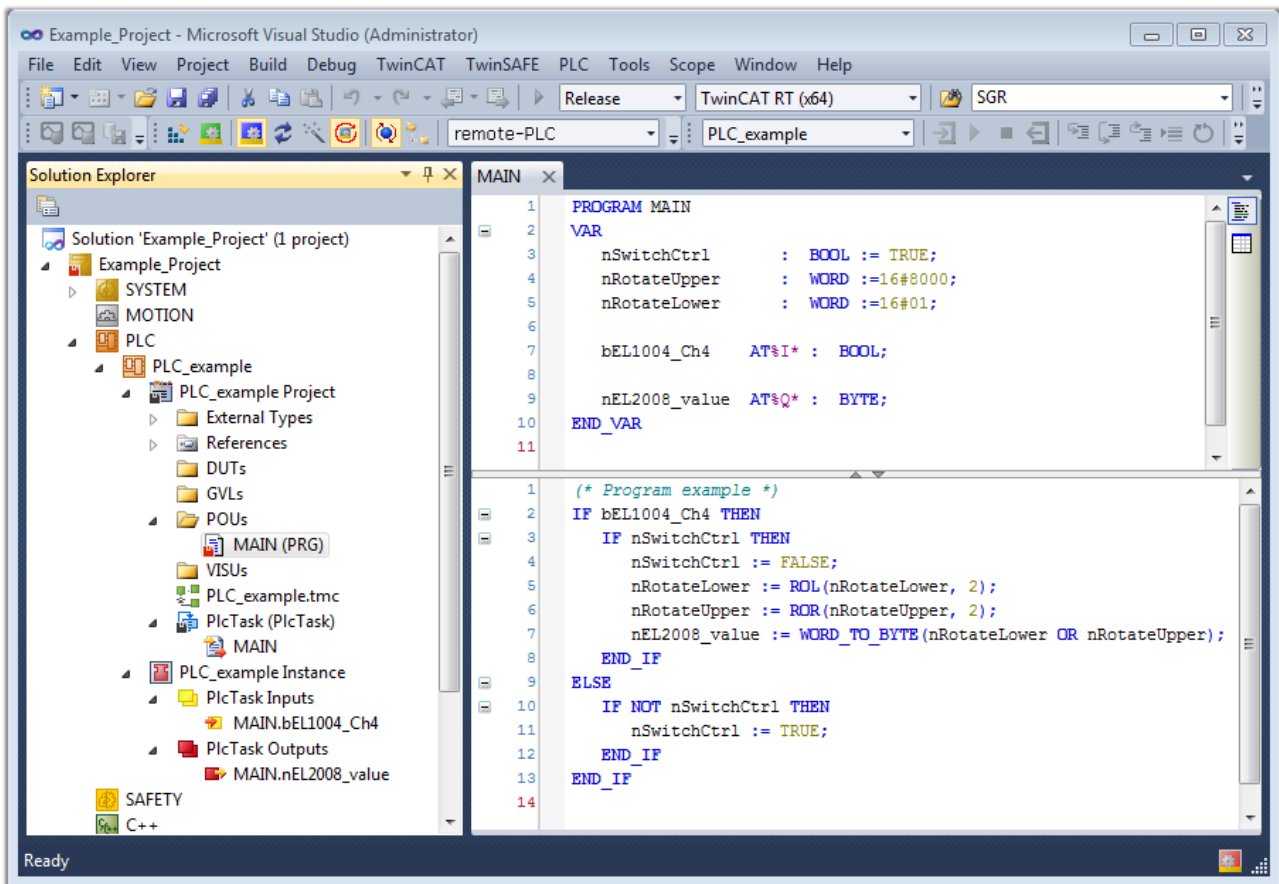

Fig. 57: Sample program with variables after a compile process (without variable integration)

The control program is now created as a project folder, followed by the compile process:

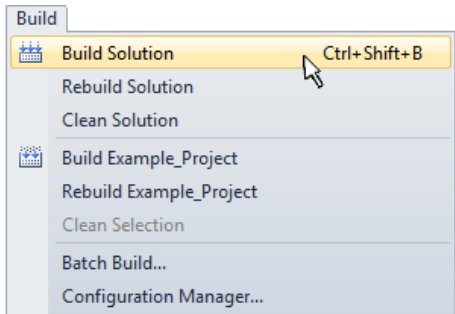
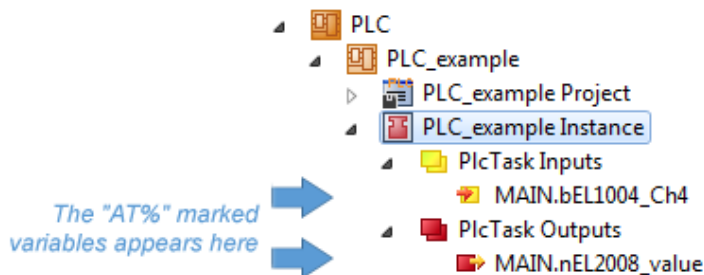

Fig. 58: Start program compilation

The following variables, identified in the ST/ PLC program with "AT%", are then available in under "Assignments" in the project folder explorer:



Assigning variables

Via the menu of an instance - variables in the "PLC" context, use the "Modify Link..." option to open a window for selecting a suitable process object (PDO) for linking:

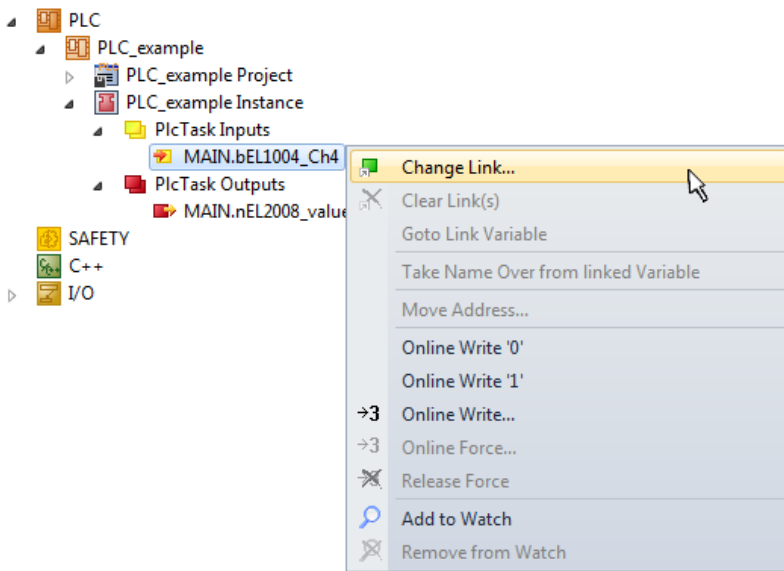

Fig. 59: Creating the links between PLC variables and process objects

In the window that opens, the process object for the variable "bEL1004_Ch4" of type BOOL can be selected from the PLC configuration tree:

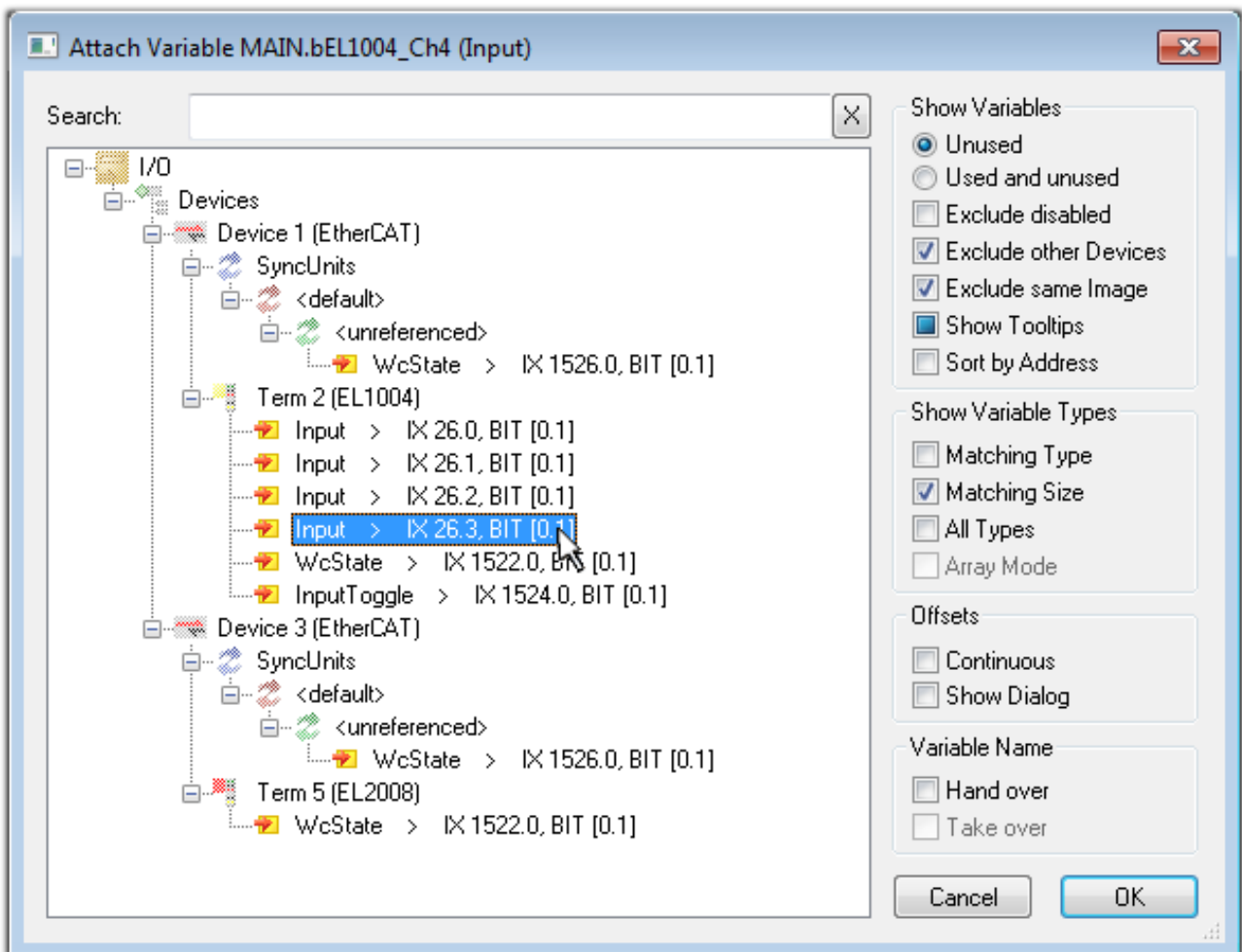

Fig. 60: Selecting PDO of type BOOL

According to the default setting, certain PDO objects are now available for selection. In this sample the input of channel 4 of the EL1004 terminal is selected for linking. In contrast, the checkbox "All types" must be ticked for creating the link for the output variables, in order to allocate a set of eight separate output bits to a byte variable. The following diagram shows the whole process:

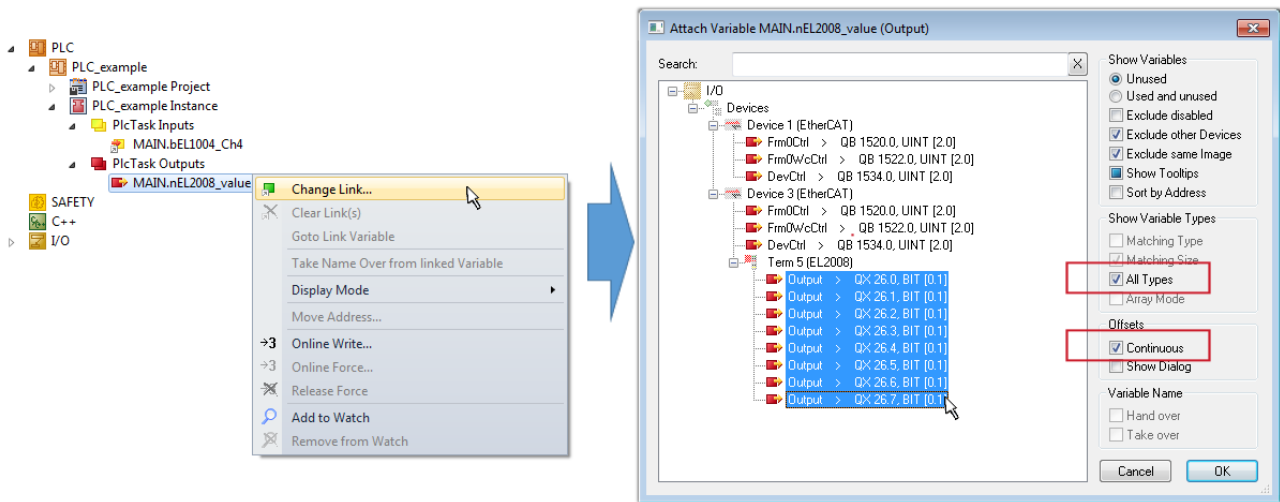



Fig. 61: Selecting several PDOs simultaneously: activate "Continuous" and "All types"

Note that the "Continuous" checkbox was also activated. This is designed to allocate the bits contained in the byte of the variable "nEL2008_value" sequentially to all eight selected output bits of the EL2008 terminal. In this way it is possible to subsequently address all eight outputs of the terminal in the program with a byte corresponding to bit 0 for channel 1 to bit 7 for channel 8 of the PLC. A special symbol () at the yellow or red object of the variable indicates that a link exists. The links can also be checked by selecting a "Goto Link Variable" from the context menu of a variable. The object opposite, in this case the PDO, is automatically selected:

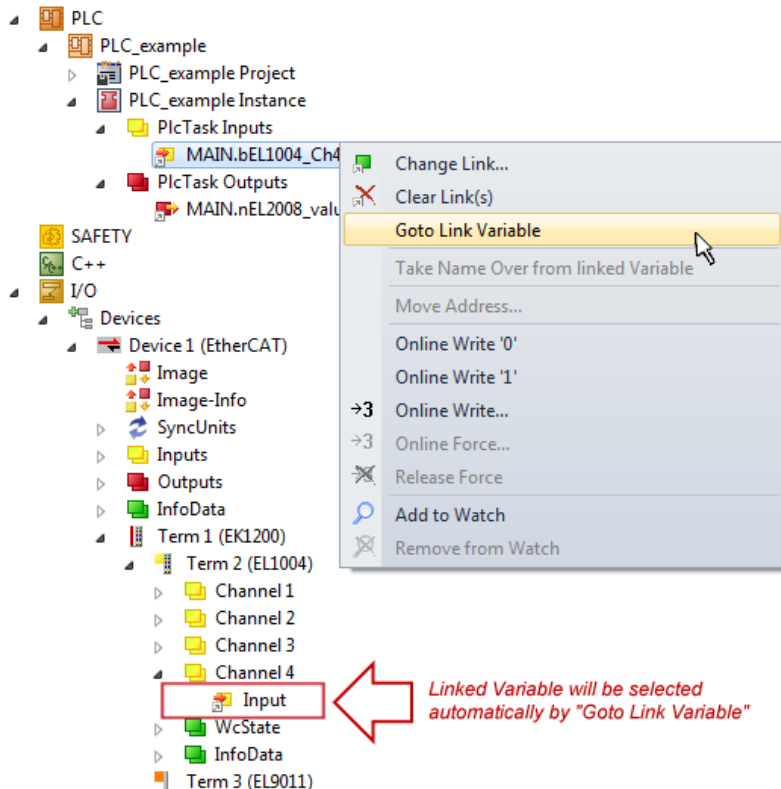

Fig. 62: Application of a "Goto Link" variable, using "MAIN.bEL1004_Ch4" as a sample

The process of creating links can also take place in the opposite direction, i.e. starting with individual PDOs to variable. However, in this example it would then not be possible to select all output bits for the EL2008, since the terminal only makes individual digital outputs available. If a terminal has a byte, word, integer or similar PDO, it is possible to allocate this a set of bit-standardised variables (type "BOOL"). Here, too, a "Goto Link Variable" from the context menu of a PDO can be executed in the other direction, so that the respective PLC instance can then be selected.

Activation of the configuration

The allocation of PDO to PLC variables has now established the connection from the controller to the inputs

and outputs of the terminals. The configuration can now be activated with  or via the menu under "TwinCAT" in order to transfer settings of the development environment to the runtime system. Confirm the messages "Old configurations are overwritten!" and "Restart TwinCAT system in Run mode" with "OK". The corresponding assignments can be seen in the project folder explorer:

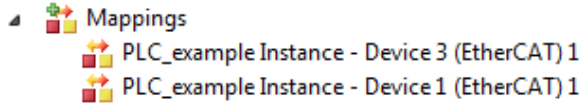



A few seconds later the corresponding status of the Run mode is displayed in the form of a rotating symbol



at the bottom right of the VS shell development environment. The PLC system can then be started as described below.

Starting the controller

Select the menu option "PLC" → "Login" or click on  to link the PLC with the real-time system and load the control program for execution. This results in the message "No program on the controller! Should the new program be loaded?", which should be acknowledged with "Yes". The runtime environment is ready for

program start by click on symbol , the "F5" key or via "PLC" in the menu selecting "Start". The started programming environment shows the runtime values of individual variables:

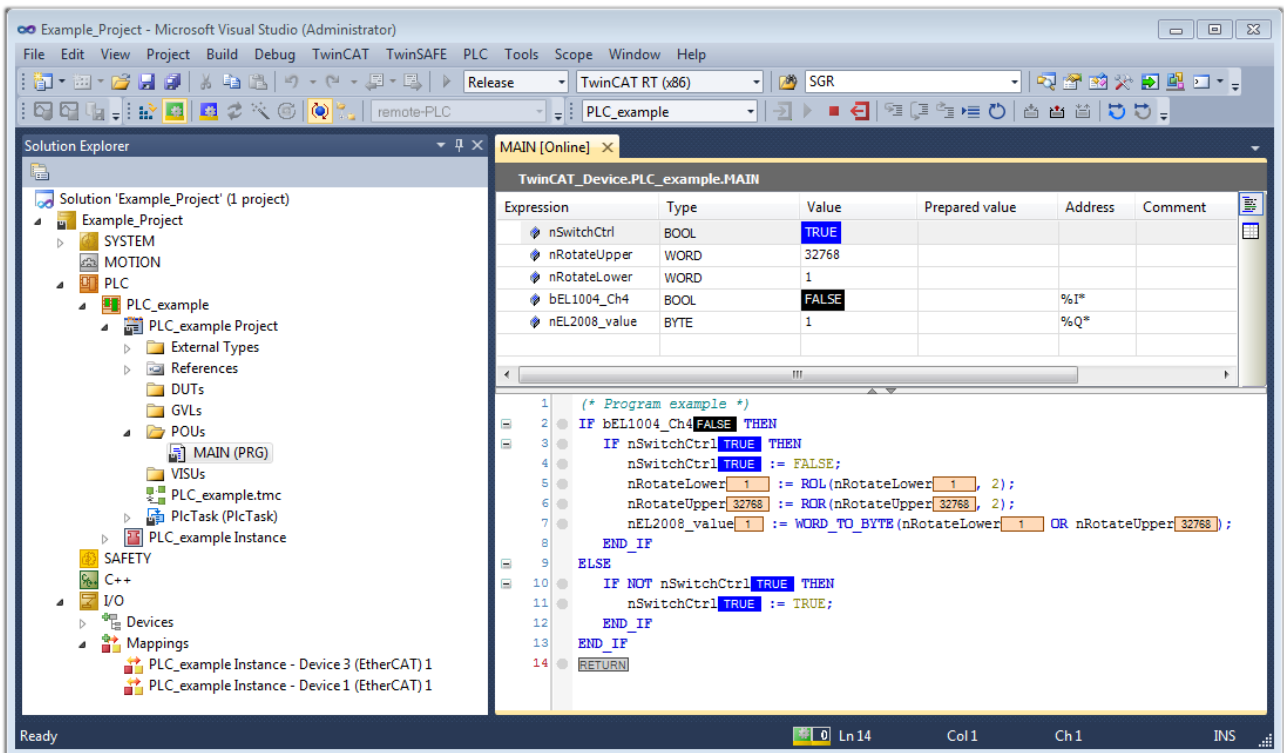

Fig. 63: TwinCAT development environment (VS shell): logged-in, after program startup

The two operator control elements for stopping  and logout  result in the required action (accordingly also for stop "Shift + F5", or both actions can be selected via the PLC menu).

6.2 TwinCAT Development Environment

The Software for automation TwinCAT (The Windows Control and Automation Technology) will be distinguished into:

- TwinCAT 2: System Manager (Configuration) & PLC Control (Programming)
- TwinCAT 3: Enhancement of TwinCAT 2 (Programming and Configuration takes place via a common Development Environment)

Details:

- **TwinCAT 2:**
 - Connects I/O devices to tasks in a variable-oriented manner
 - Connects tasks to tasks in a variable-oriented manner
 - Supports units at the bit level
 - Supports synchronous or asynchronous relationships
 - Exchange of consistent data areas and process images
 - Datalink on NT - Programs by open Microsoft Standards (OLE, OCX, ActiveX, DCOM+, etc.)
 - Integration of IEC 61131-3-Software-SPS, Software- NC and Software-CNC within Windows NT/2000/XP/Vista, Windows 7, NT/XP Embedded, CE
 - Interconnection to all common fieldbusses
 - More...

Additional features:

- **TwinCAT 3 (eXtended Automation):**
 - Visual-Studio®-Integration
 - Choice of the programming language
 - Supports object orientated extension of IEC 61131-3
 - Usage of C/C++ as programming language for real time applications
 - Connection to MATLAB®/Simulink®
 - Open interface for expandability
 - Flexible run-time environment
 - Active support of Multi-Core- und 64-Bit-Operatingsystem
 - Automatic code generation and project creation with the TwinCAT Automation Interface
 - More...

Within the following sections commissioning of the TwinCAT Development Environment on a PC System for the control and also the basically functions of unique control elements will be explained.

Please see further information to TwinCAT 2 and TwinCAT 3 at <http://infosys.beckhoff.com>.

6.2.1 Installation of the TwinCAT real-time driver

In order to assign real-time capability to a standard Ethernet port of an IPC controller, the Beckhoff real-time driver has to be installed on this port under Windows.

This can be done in several ways. One option is described here.

In the System Manager call up the TwinCAT overview of the local network interfaces via Options → Show Real Time Ethernet Compatible Devices.

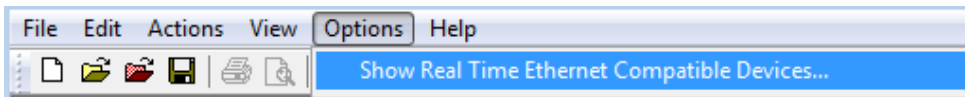

Fig. 64: System Manager "Options" (TwinCAT 2)

This has to be called up by the Menü "TwinCAT" within the TwinCAT 3 environment:

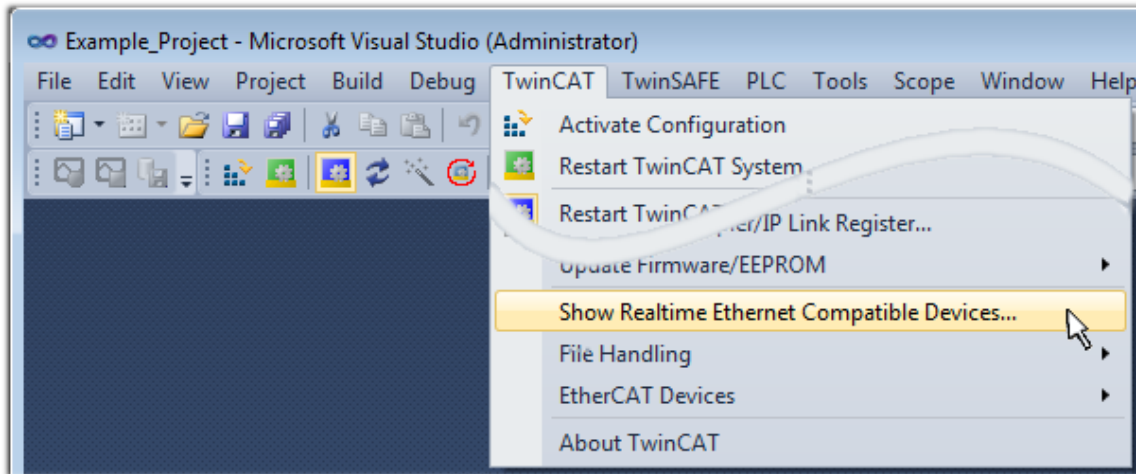

Fig. 65: Call up under VS Shell (TwinCAT 3)

The following dialog appears:

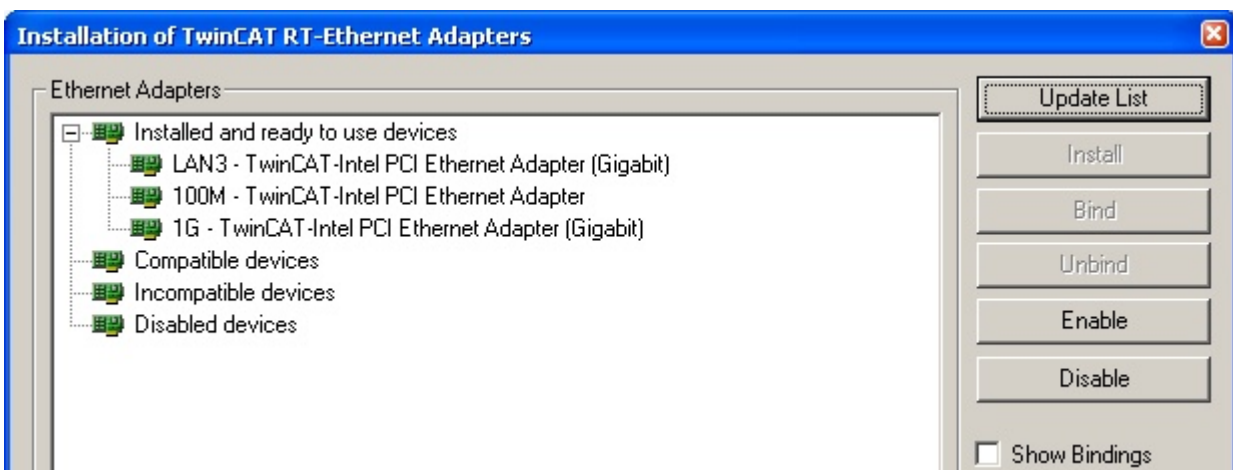

Fig. 66: Overview of network interfaces

Interfaces listed under "Compatible devices" can be assigned a driver via the "Install" button. A driver should only be installed on compatible devices.

A Windows warning regarding the unsigned driver can be ignored.

Alternatively an EtherCAT-device can be inserted first of all as described in chapter [Offline configuration creation, section "Creating the EtherCAT device" \[▶ 70\]](#) in order to view the compatible ethernet ports via its EtherCAT properties (tab „Adapter“, button „Compatible Devices...“):



Fig. 67: EtherCAT device properties(TwinCAT 2): click on „Compatible Devices...“ of tab “Adapter”

TwinCAT 3: the properties of the EtherCAT device can be opened by double click on “Device .. (EtherCAT)” within the Solution Explorer under “I/O”:

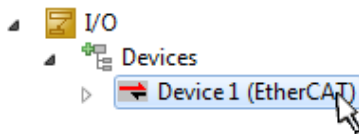

After the installation the driver appears activated in the Windows overview for the network interface (Windows Start → System Properties → Network)

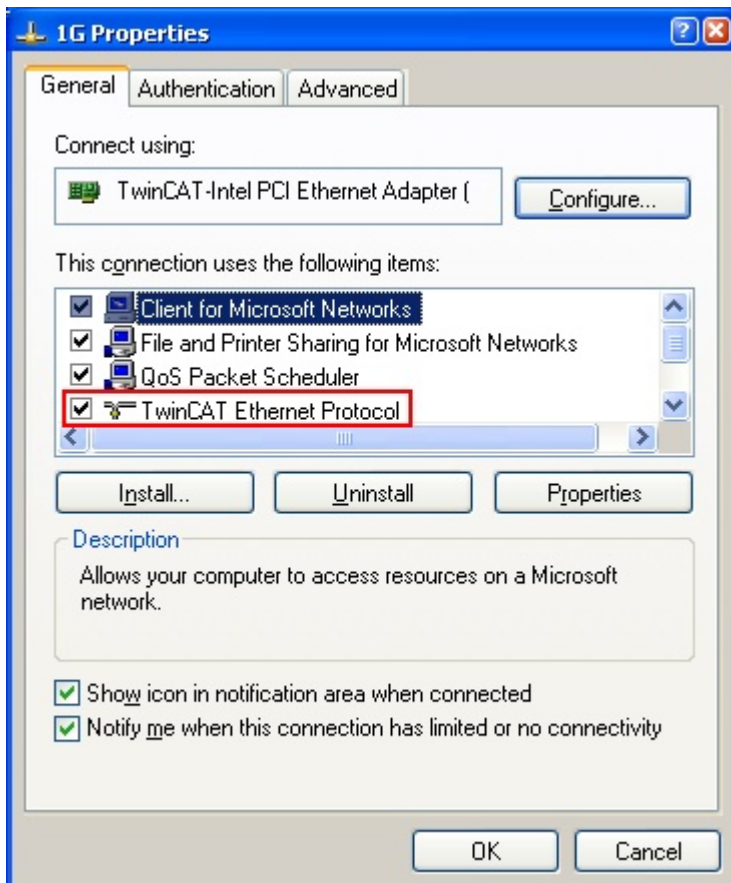

Fig. 68: Windows properties of the network interface

A correct setting of the driver could be:

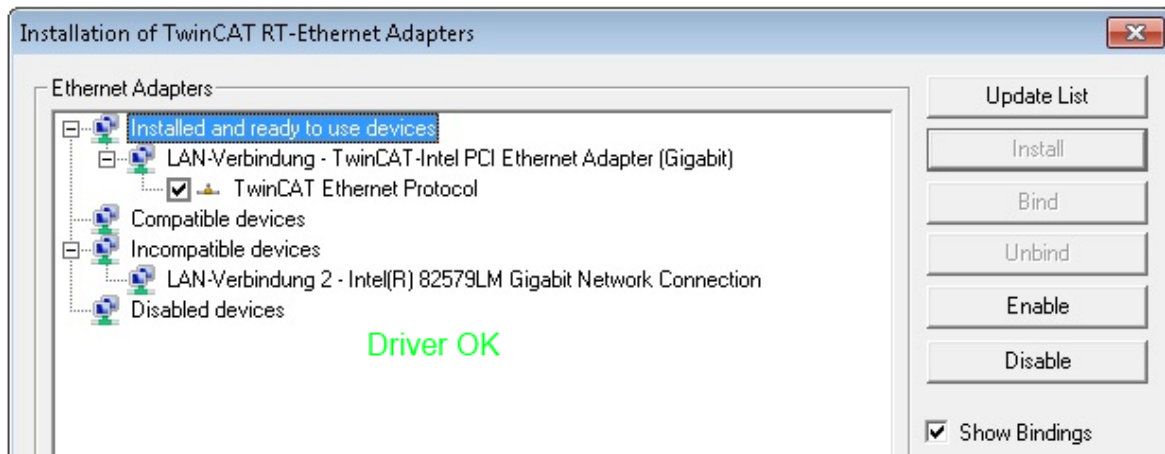

Fig. 69: Exemplary correct driver setting for the Ethernet port

Other possible settings have to be avoided:

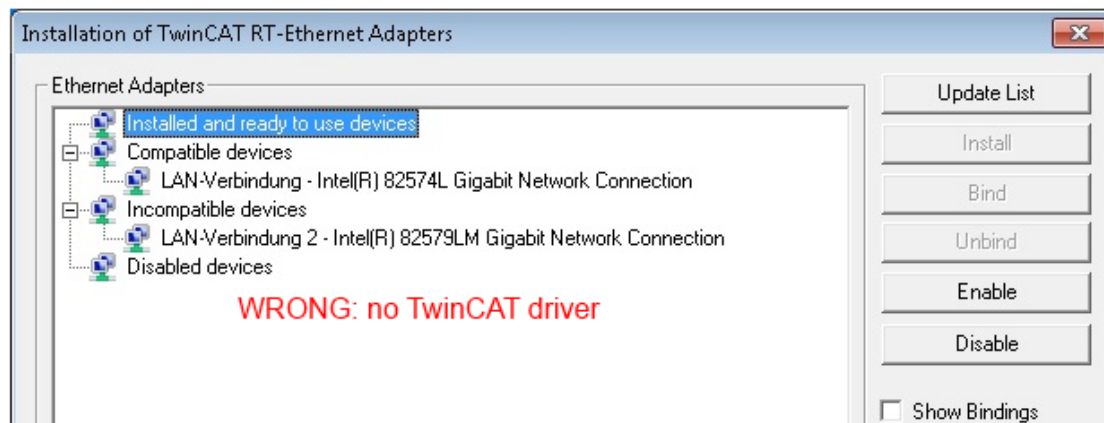
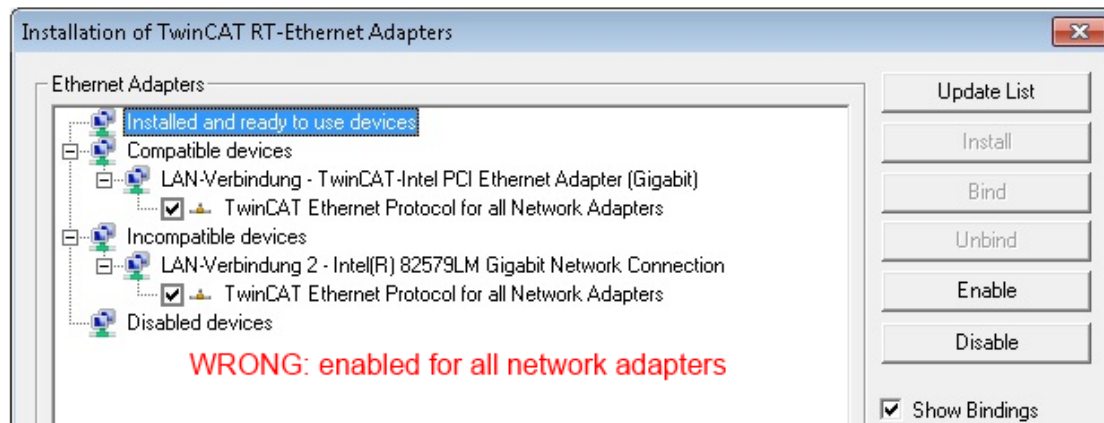
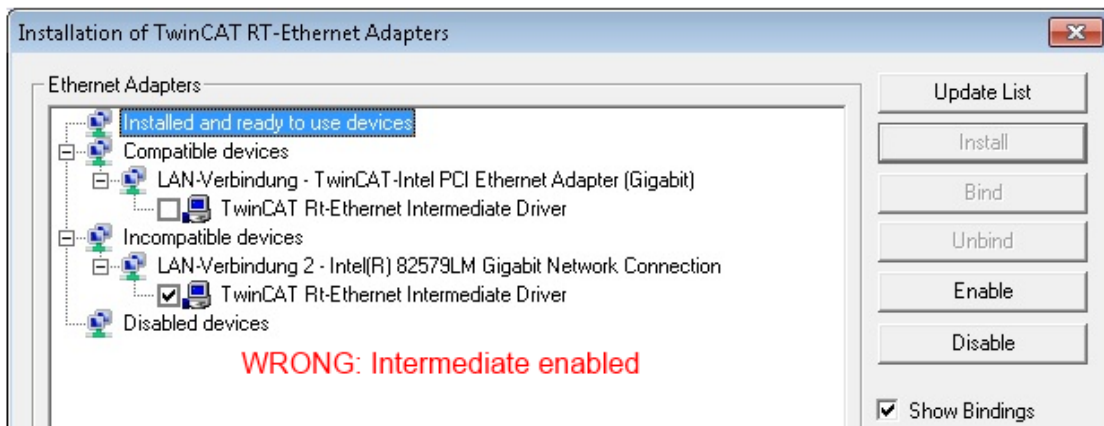
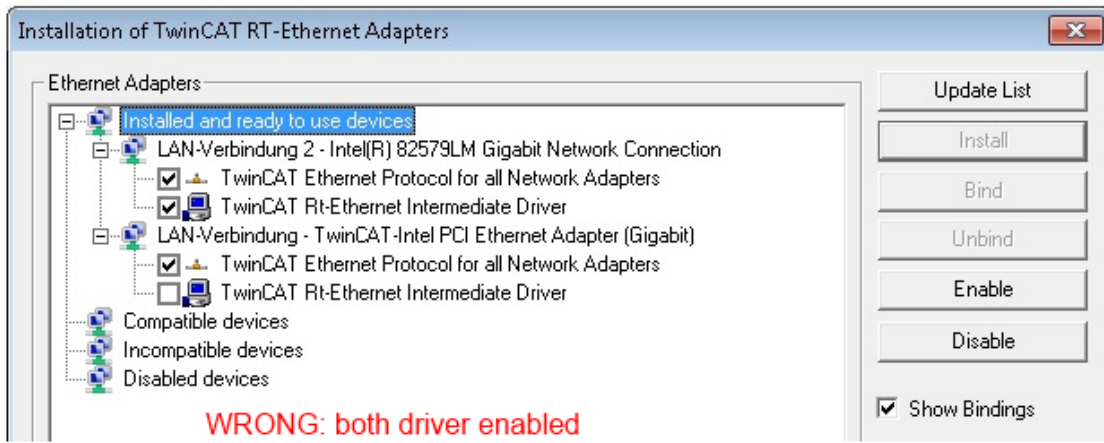

Fig. 70: Incorrect driver settings for the Ethernet port

IP address of the port used

● IP address/DHCP

i In most cases an Ethernet port that is configured as an EtherCAT device will not transport general IP packets. For this reason and in cases where an EL6601 or similar devices are used it is useful to specify a fixed IP address for this port via the “Internet Protocol TCP/IP” driver setting and to disable DHCP. In this way the delay associated with the DHCP client for the Ethernet port assigning itself a default IP address in the absence of a DHCP server is avoided. A suitable address space is 192.168.x.x, for example.

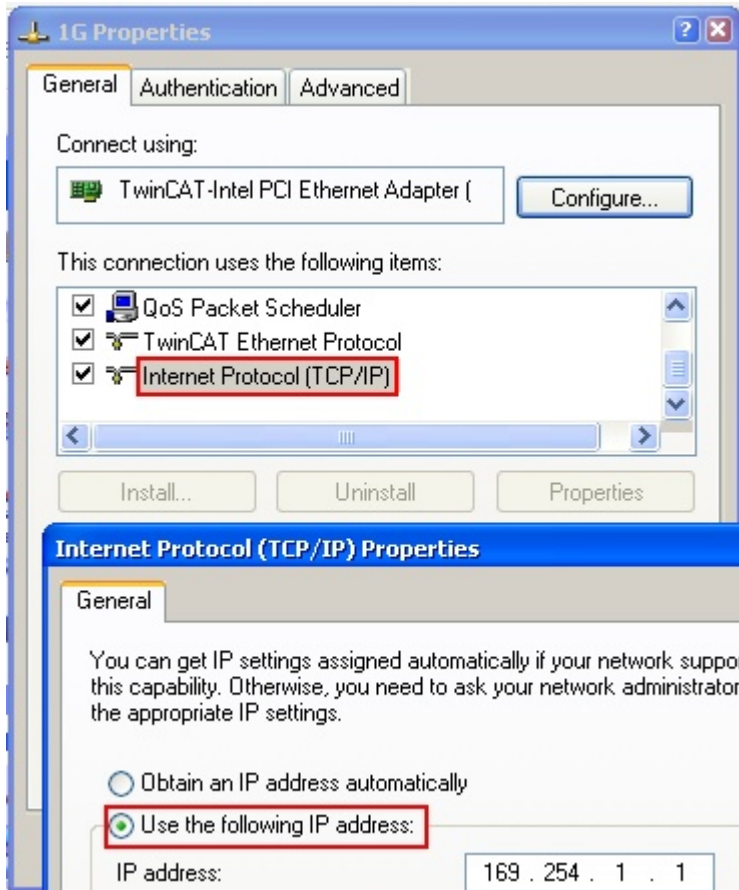

Fig. 71: TCP/IP setting for the Ethernet port

6.2.2 Notes regarding ESI device description

Installation of the latest ESI device description

The TwinCAT EtherCAT master/System Manager needs the device description files for the devices to be used in order to generate the configuration in online or offline mode. The device descriptions are contained in the so-called ESI files (EtherCAT Slave Information) in XML format. These files can be requested from the respective manufacturer and are made available for download. An *.xml file may contain several device descriptions.

The ESI files for Beckhoff EtherCAT devices are available on the [Beckhoff website](#).

The ESI files should be stored in the TwinCAT installation directory.

Default settings:

- **TwinCAT 2:** C:\TwinCAT\IO\EtherCAT
- **TwinCAT 3:** C:\TwinCAT\3.1\Config\Io\EtherCAT

The files are read (once) when a new System Manager window is opened, if they have changed since the last time the System Manager window was opened.

A TwinCAT installation includes the set of Beckhoff ESI files that was current at the time when the TwinCAT build was created.

For TwinCAT 2.11/TwinCAT 3 and higher, the ESI directory can be updated from the System Manager, if the programming PC is connected to the Internet; by

- **TwinCAT 2:** Option → “Update EtherCAT Device Descriptions”
- **TwinCAT 3:** TwinCAT → EtherCAT Devices → “Update Device Descriptions (via ETG Website)...”

The [TwinCAT ESI Updater \[▶ 69\]](#) is available for this purpose.



ESI

The *.xml files are associated with *.xsd files, which describe the structure of the ESI XML files. To update the ESI device descriptions, both file types should therefore be updated.

Device differentiation

EtherCAT devices/slaves are distinguished by four properties, which determine the full device identifier. For example, the device identifier EL2521-0025-1018 consists of:

- family key “EL”
- name “2521”
- type “0025”
- and revision “1018”

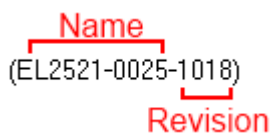

Fig. 72: Identifier structure

The order identifier consisting of name + type (here: EL2521-0010) describes the device function. The revision indicates the technical progress and is managed by Beckhoff. In principle, a device with a higher revision can replace a device with a lower revision, unless specified otherwise, e.g. in the documentation. Each revision has its own ESI description. See [further notes \[▶ 7\]](#).

Online description

If the EtherCAT configuration is created online through scanning of real devices (see section Online setup) and no ESI descriptions are available for a slave (specified by name and revision) that was found, the System Manager asks whether the description stored in the device should be used. In any case, the System Manager needs this information for setting up the cyclic and acyclic communication with the slave correctly.

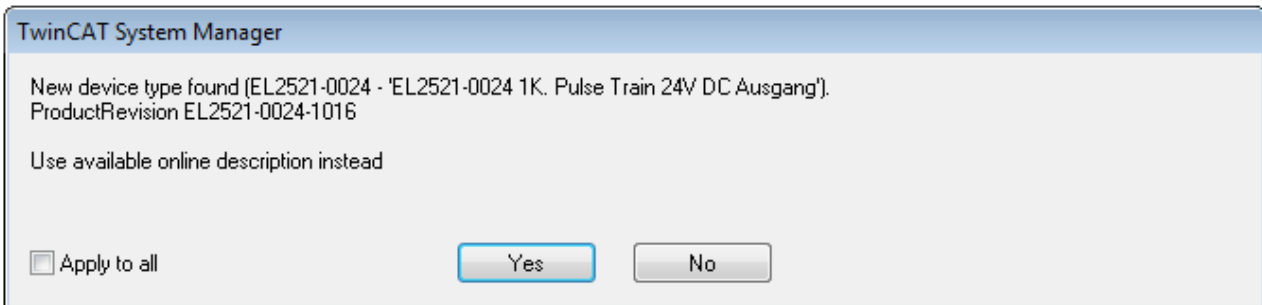

Fig. 73: *OnlineDescription information window (TwinCAT 2)*

In TwinCAT 3 a similar window appears, which also offers the Web update:

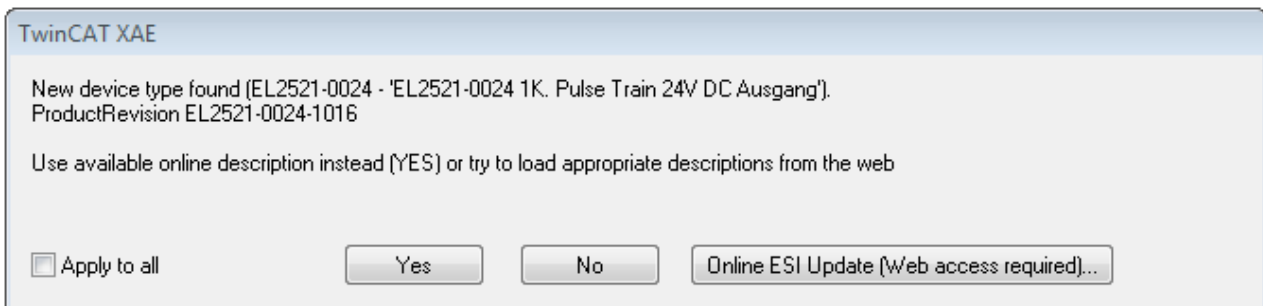

Fig. 74: *Information window OnlineDescription (TwinCAT 3)*

If possible, the Yes is to be rejected and the required ESI is to be requested from the device manufacturer. After installation of the XML/XSD file the configuration process should be repeated.

NOTE

Changing the 'usual' configuration through a scan

- ✓ If a scan discovers a device that is not yet known to TwinCAT, distinction has to be made between two cases. Taking the example here of the EL2521-0000 in the revision 1019
 - a) no ESI is present for the EL2521-0000 device at all, either for the revision 1019 or for an older revision. The ESI must then be requested from the manufacturer (in this case Beckhoff).
 - b) an ESI is present for the EL2521-0000 device, but only in an older revision, e.g. 1018 or 1017. In this case an in-house check should first be performed to determine whether the spare parts stock allows the integration of the increased revision into the configuration at all. A new/higher revision usually also brings along new features. If these are not to be used, work can continue without reservations with the previous revision 1018 in the configuration. This is also stated by the Beckhoff compatibility rule.

Refer in particular to the chapter '[General notes on the use of Beckhoff EtherCAT IO components](#)' and for manual configuration to the chapter '[Offline configuration creation](#)' [[▶ 70](#)].

If the OnlineDescription is used regardless, the System Manager reads a copy of the device description from the EEPROM in the EtherCAT slave. In complex slaves the size of the EEPROM may not be sufficient for the complete ESI, in which case the ESI would be *incomplete* in the configurator. Therefore it's recommended using an offline ESI file with priority in such a case.

The System Manager creates for online recorded device descriptions a new file "OnlineDescription0000...xml" in its ESI directory, which contains all ESI descriptions that were read online.

OnlineDescriptionCache00000002.xml

Fig. 75: File OnlineDescription.xml created by the System Manager

If a slave desired to be added manually to the configuration at a later stage, online created slaves are indicated by a prepended symbol ">" in the selection list (see Figure "Indication of an online recorded ESI of EL2521 as an example").

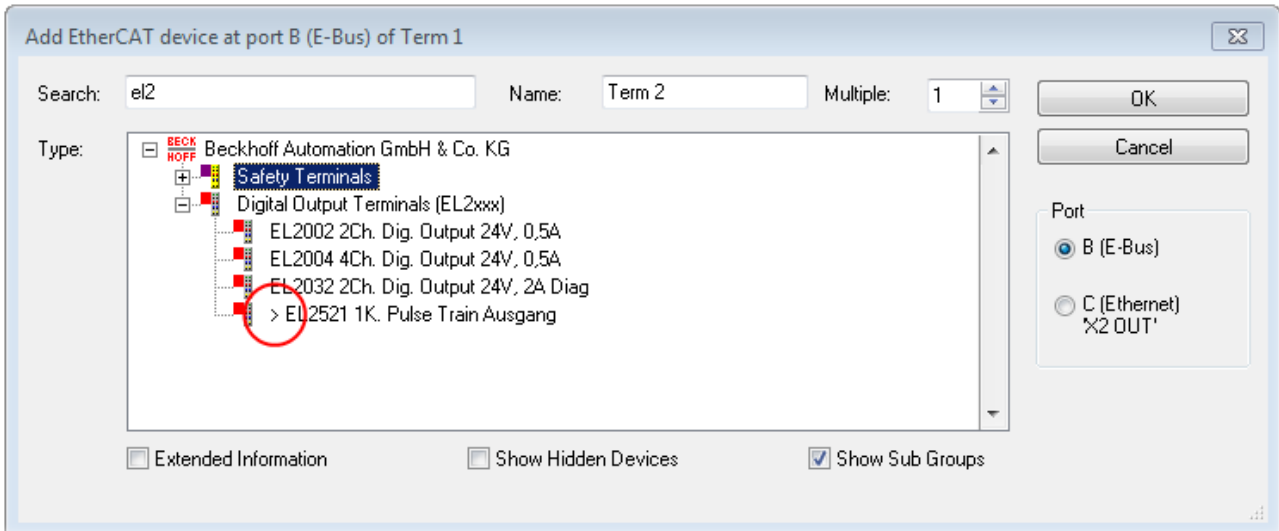

Fig. 76: Indication of an online recorded ESI of EL2521 as an example

If such ESI files are used and the manufacturer's files become available later, the file OnlineDescription.xml should be deleted as follows:

- close all System Manager windows
- restart TwinCAT in Config mode
- delete "OnlineDescription0000...xml"
- restart TwinCAT System Manager

This file should not be visible after this procedure, if necessary press <F5> to update

i OnlineDescription for TwinCAT 3.x

In addition to the file described above "OnlineDescription0000...xml", a so called EtherCAT cache with new discovered devices is created by TwinCAT 3.x, e.g. under Windows 7:

```
C:\User\[USERNAME]\AppData\Roaming\Beckhoff\TwinCAT3\Components\Base\EtherCATCache.xml
```

(Please note the language settings of the OS!)
You have to delete this file, too.

Faulty ESI file

If an ESI file is faulty and the System Manager is unable to read it, the System Manager brings up an information window.

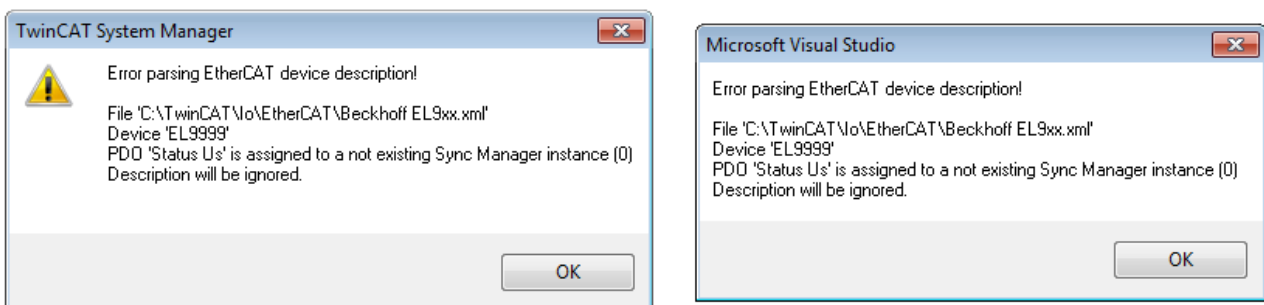

Fig. 77: Information window for faulty ESI file (left: TwinCAT 2; right: TwinCAT 3)

Reasons may include:

- Structure of the *.xml does not correspond to the associated *.xsd file → check your schematics
- Contents cannot be translated into a device description → contact the file manufacturer

6.2.3 TwinCAT ESI Updater

For TwinCAT 2.11 and higher, the System Manager can search for current Beckhoff ESI files automatically, if an online connection is available:

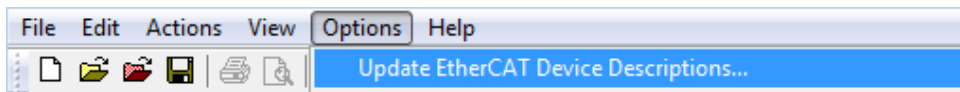

Fig. 78: Using the ESI Updater (>= TwinCAT 2.11)

The call up takes place under:
 "Options" → "Update EtherCAT Device Descriptions"

Selection under TwinCAT 3:

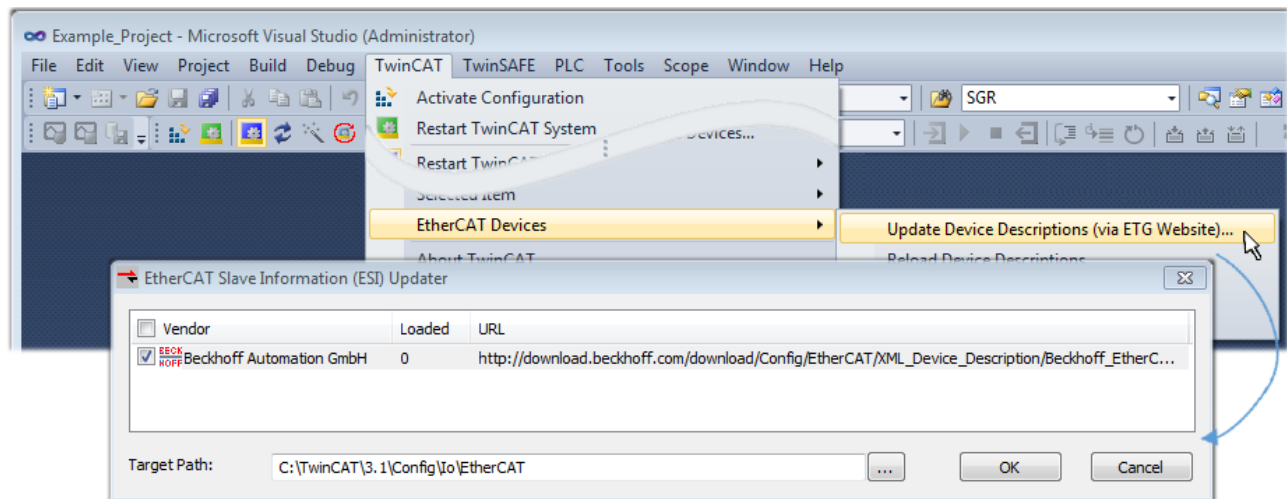

Fig. 79: Using the ESI Updater (TwinCAT 3)

The ESI Updater (TwinCAT 3) is a convenient option for automatic downloading of ESI data provided by EtherCAT manufacturers via the Internet into the TwinCAT directory (ESI = EtherCAT slave information). TwinCAT accesses the central ESI ULR directory list stored at ETG; the entries can then be viewed in the Updater dialog, although they cannot be changed there.

The call up takes place under:
 "TwinCAT" → „EtherCAT Devices“ → “Update Device Description (via ETG Website)...“.

6.2.4 Distinction between Online and Offline

The distinction between online and offline refers to the presence of the actual I/O environment (drives, terminals, EJ-modules). If the configuration is to be prepared in advance of the system configuration as a programming system, e.g. on a laptop, this is only possible in "Offline configuration" mode. In this case all components have to be entered manually in the configuration, e.g. based on the electrical design.

If the designed control system is already connected to the EtherCAT system and all components are energised and the infrastructure is ready for operation, the TwinCAT configuration can simply be generated through "scanning" from the runtime system. This is referred to as online configuration.

In any case, during each startup the EtherCAT master checks whether the slaves it finds match the configuration. This test can be parameterised in the extended slave settings. Refer to note "Installation of the latest ESI-XML device description" [▶ 65].

For preparation of a configuration:

- the real EtherCAT hardware (devices, couplers, drives) must be present and installed
- the devices/modules must be connected via EtherCAT cables or in the terminal/ module strand in the same way as they are intended to be used later

- the devices/modules be connected to the power supply and ready for communication
- TwinCAT must be in CONFIG mode on the target system.

The online scan process consists of:

- detecting the EtherCAT device [▶ 75] (Ethernet port at the IPC)
- detecting the connected EtherCAT devices [▶ 76]. This step can be carried out independent of the preceding step
- troubleshooting [▶ 79]

The scan with existing configuration [▶ 80] can also be carried out for comparison.

6.2.5 OFFLINE configuration creation

Creating the EtherCAT device

Create an EtherCAT device in an empty System Manager window.

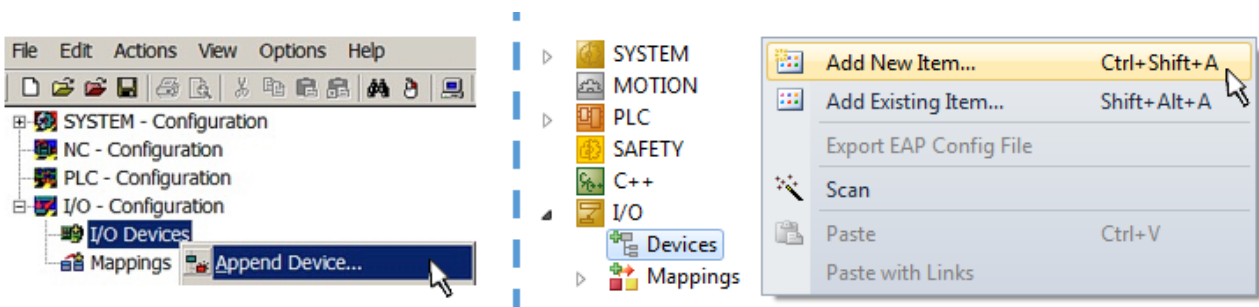

Fig. 80: Append EtherCAT device (left: TwinCAT 2; right: TwinCAT 3)

Select type 'EtherCAT' for an EtherCAT I/O application with EtherCAT slaves. For the present publisher/ subscriber service in combination with an EL6601/EL6614 terminal select "EtherCAT Automation Protocol via EL6601".

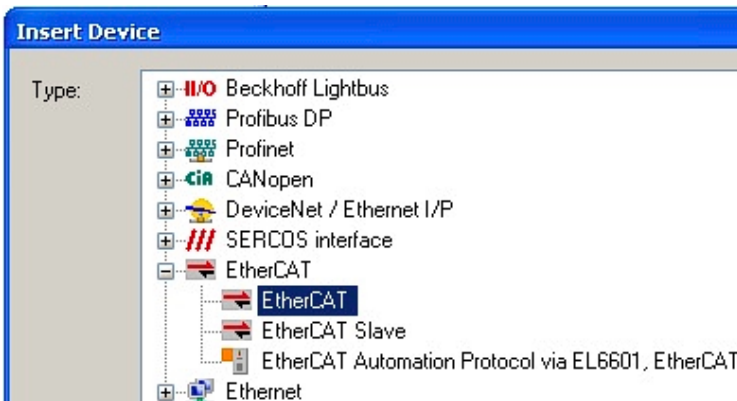

Fig. 81: Selecting the EtherCAT connection (TwinCAT 2.11, TwinCAT 3)

Then assign a real Ethernet port to this virtual device in the runtime system.

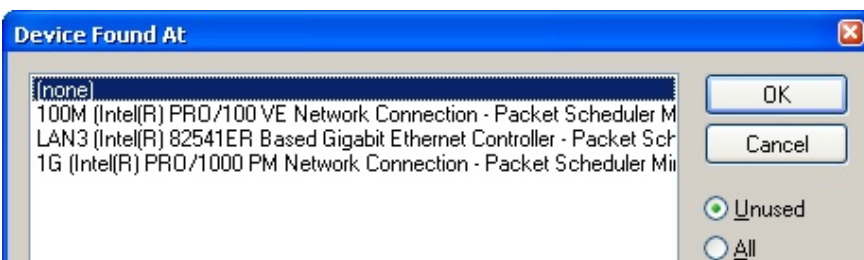

Fig. 82: Selecting the Ethernet port

This query may appear automatically when the EtherCAT device is created, or the assignment can be set/modified later in the properties dialog; see Fig. “EtherCAT device properties (TwinCAT 2)”.

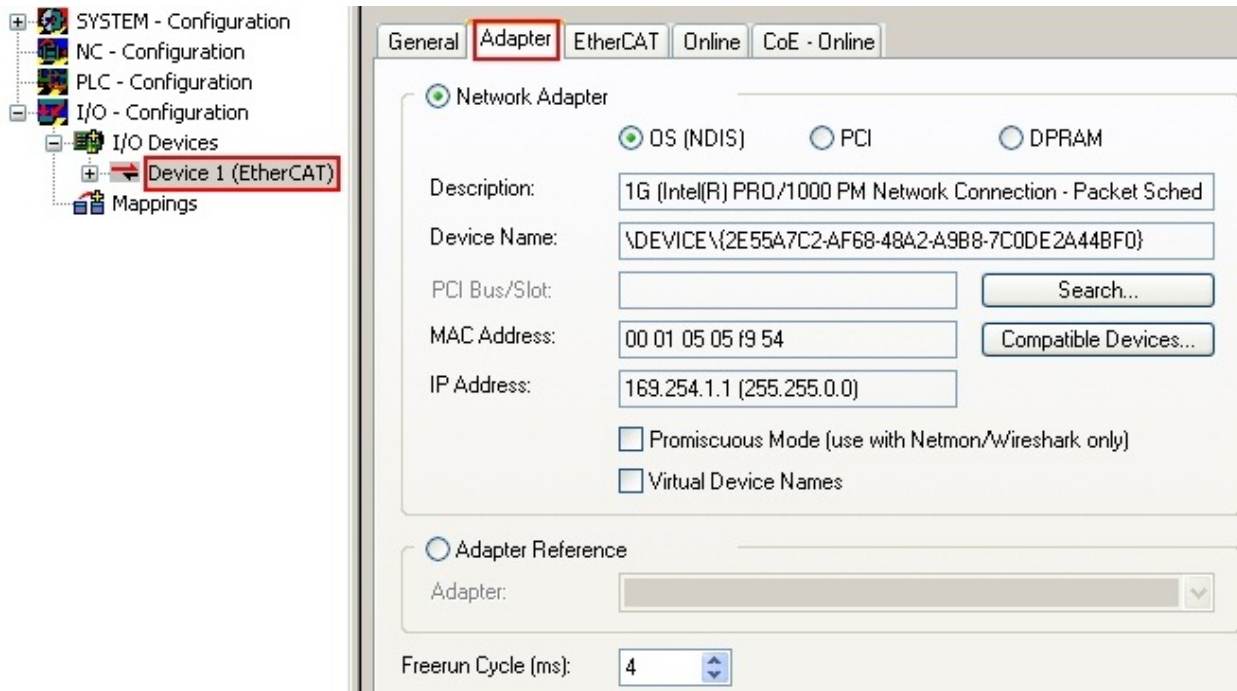
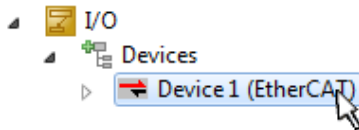

Fig. 83: EtherCAT device properties (TwinCAT 2)

TwinCAT 3: the properties of the EtherCAT device can be opened by double click on “Device .. (EtherCAT)” within the Solution Explorer under “I/O”:



i **Selecting the Ethernet port**

Ethernet ports can only be selected for EtherCAT devices for which the TwinCAT real-time driver is installed. This has to be done separately for each port. Please refer to the respective [installation page \[p. 59\]](#).

Defining EtherCAT slaves

Further devices can be appended by right-clicking on a device in the configuration tree.

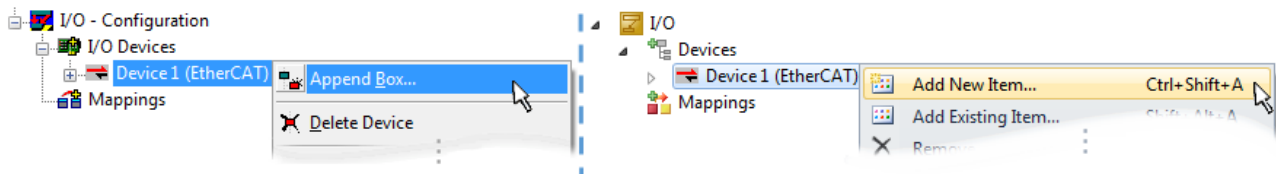

Fig. 84: Appending EtherCAT devices (left: TwinCAT 2; right: TwinCAT 3)

The dialog for selecting a new device opens. Only devices for which ESI files are available are displayed.

Only devices are offered for selection that can be appended to the previously selected device. Therefore the physical layer available for this port is also displayed (Fig. “Selection dialog for new EtherCAT device”, A). In the case of cable-based Fast-Ethernet physical layer with PHY transfer, then also only cable-based devices are available, as shown in Fig. “Selection dialog for new EtherCAT device”. If the preceding device has several free ports (e.g. EK1122 or EK1100), the required port can be selected on the right-hand side (A).

Overview of physical layer

- “Ethernet”: cable-based 100BASE-TX: EK couplers, EP boxes, devices with RJ45/M8/M12 connector

- “E-Bus”: LVDS “terminal bus”, “EJ-module”: EL/ES terminals, various modular modules

The search field facilitates finding specific devices (since TwinCAT 2.11 or TwinCAT 3).

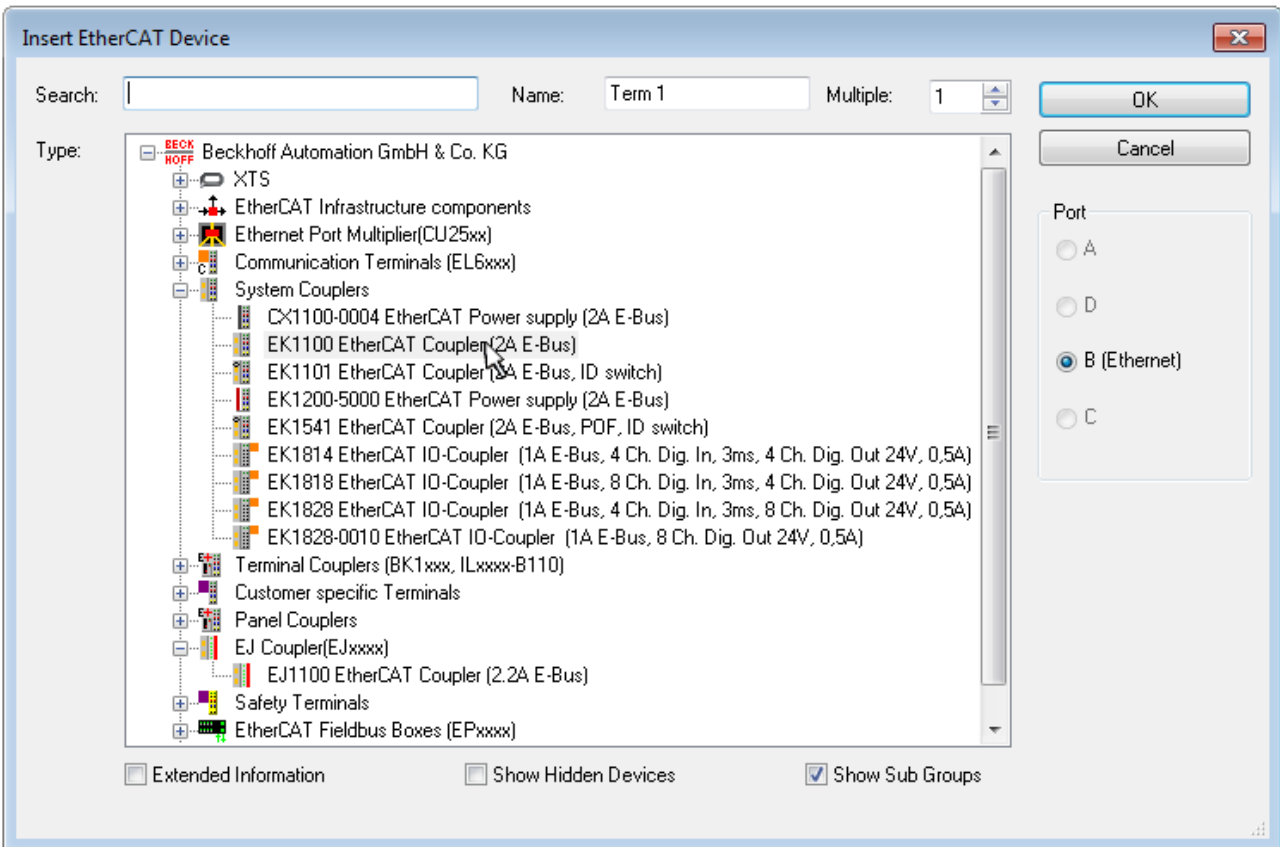

Fig. 85: Selection dialog for new EtherCAT device

By default only the name/device type is used as selection criterion. For selecting a specific revision of the device the revision can be displayed as “Extended Information”.

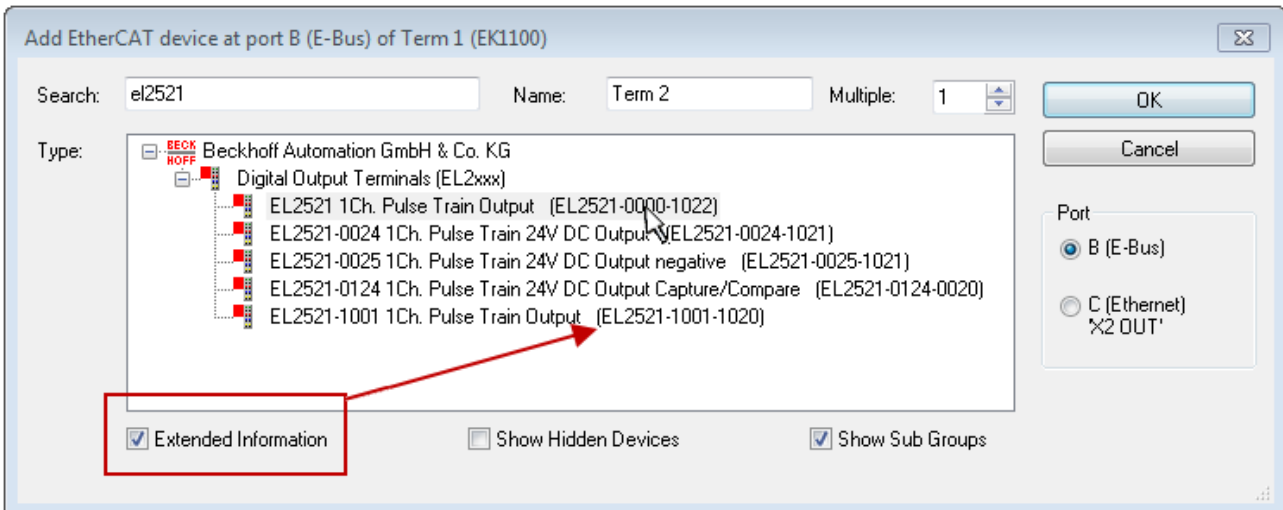

Fig. 86: Display of device revision

In many cases several device revisions were created for historic or functional reasons, e.g. through technological advancement. For simplification purposes (see Fig. “Selection dialog for new EtherCAT device”) only the last (i.e. highest) revision and therefore the latest state of production is displayed in the selection dialog for Beckhoff devices. To show all device revisions available in the system as ESI descriptions tick the “Show Hidden Devices” check box, see Fig. “Display of previous revisions”.

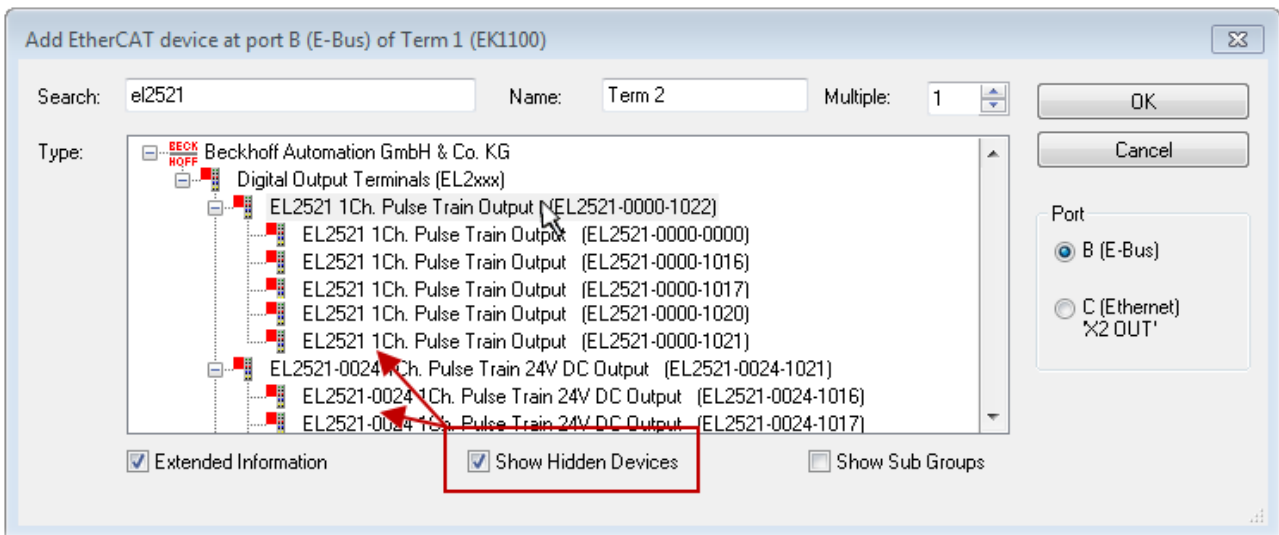

Fig. 87: Display of previous revisions

i Device selection based on revision, compatibility

The ESI description also defines the process image, the communication type between master and slave/device and the device functions, if applicable. The physical device (firmware, if available) has to support the communication queries/settings of the master. This is backward compatible, i.e. newer devices (higher revision) should be supported if the EtherCAT master addresses them as an older revision. The following compatibility rule of thumb is to be assumed for Beckhoff EtherCAT Terminals/ Boxes/ EJ-modules:

device revision in the system >= device revision in the configuration

This also enables subsequent replacement of devices without changing the configuration (different specifications are possible for drives).

Example:

If an EL2521-0025-1018 is specified in the configuration, an EL2521-0025-1018 or higher (-1019, -1020) can be used in practice.

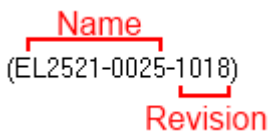

Fig. 88: Name/revision of the terminal

If current ESI descriptions are available in the TwinCAT system, the last revision offered in the selection dialog matches the Beckhoff state of production. It is recommended to use the last device revision when creating a new configuration, if current Beckhoff devices are used in the real application. Older revisions should only be used if older devices from stock are to be used in the application.

In this case the process image of the device is shown in the configuration tree and can be parameterised as follows: linking with the task, CoE/DC settings, plug-in definition, startup settings, ...

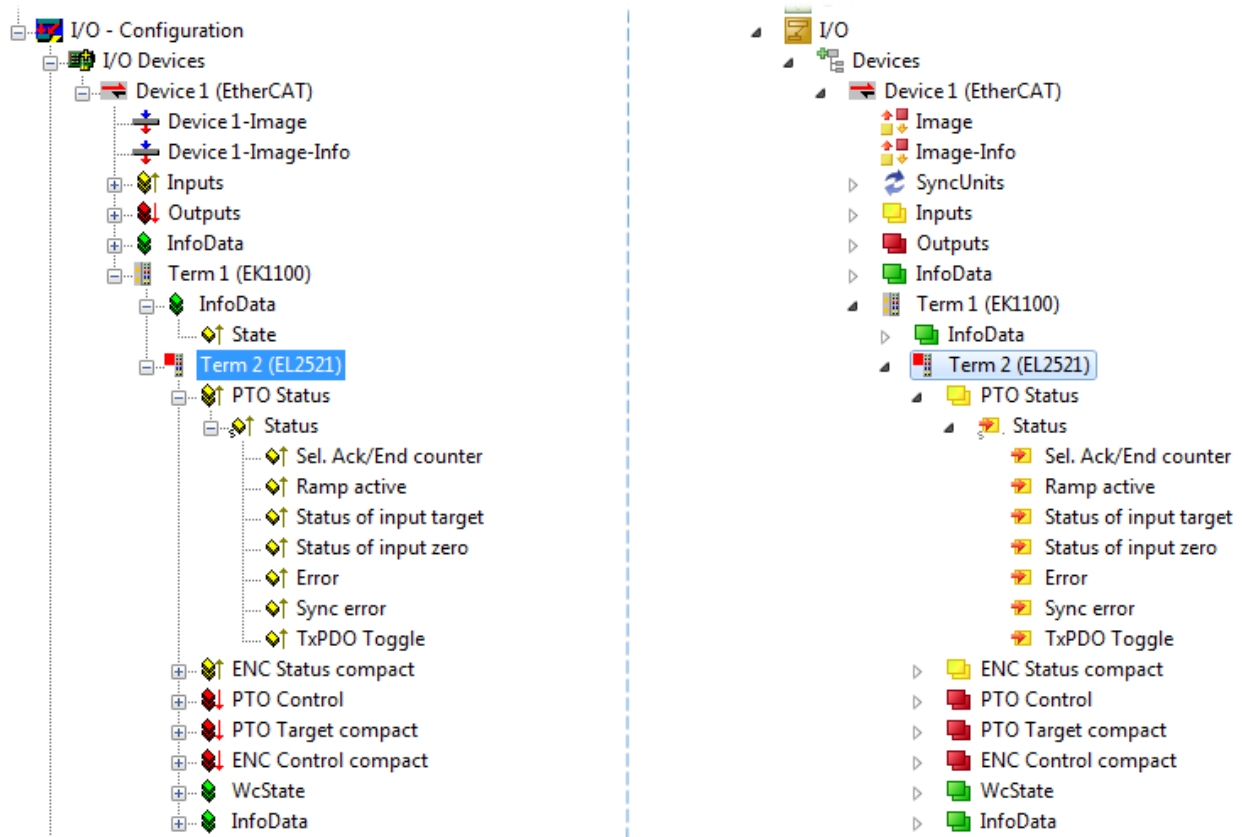



Fig. 89: EtherCAT terminal in the TwinCAT tree (left: TwinCAT 2; right: TwinCAT 3)



6.2.6 ONLINE configuration creation

Detecting/scanning of the EtherCAT device

The online device search can be used if the TwinCAT system is in CONFIG mode. This can be indicated by a symbol right below in the information bar:



- on TwinCAT 2 by a blue display “Config Mode” within the System Manager window:  .
- on TwinCAT 3 within the user interface of the development environment by a symbol  .

TwinCAT can be set into this mode:

- TwinCAT 2: by selection of  in the Menubar or by “Actions” → “Set/Reset TwinCAT to Config Mode...”
- TwinCAT 3: by selection of  in the Menubar or by „TwinCAT“ → “Restart TwinCAT (Config Mode)”

● Online scanning in Config mode

i The online search is not available in RUN mode (production operation). Note the differentiation between TwinCAT programming system and TwinCAT target system.

The TwinCAT 2 icon () or TwinCAT 3 icon () within the Windows-Taskbar always shows the TwinCAT mode of the local IPC. Compared to that, the System Manager window of TwinCAT 2 or the user interface of TwinCAT 3 indicates the state of the target system.

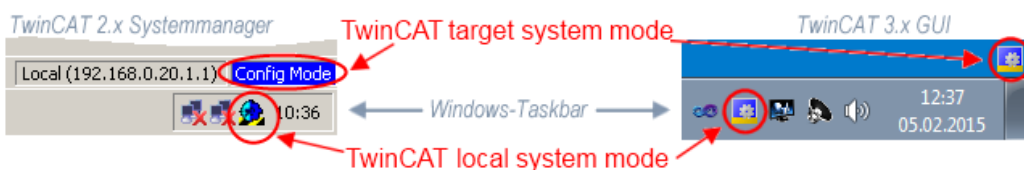

Fig. 90: Differentiation local/target system (left: TwinCAT 2; right: TwinCAT 3)

Right-clicking on “I/O Devices” in the configuration tree opens the search dialog.

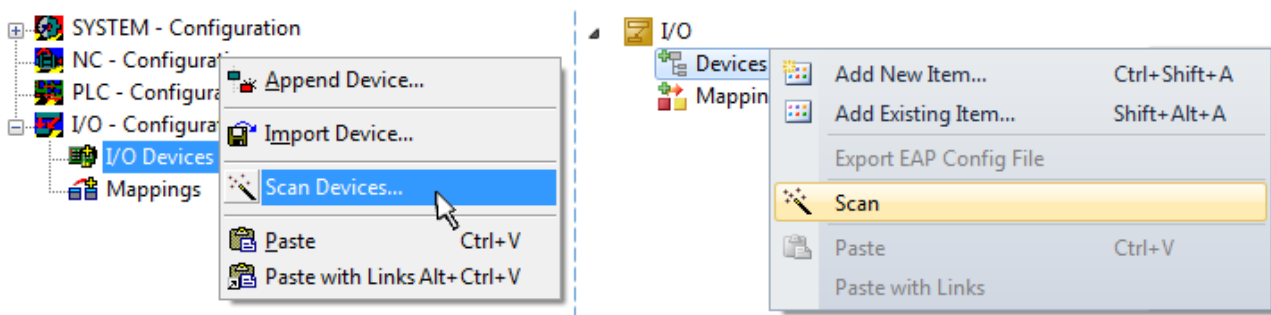

Fig. 91: Scan Devices (left: TwinCAT 2; right: TwinCAT 3)

This scan mode attempts to find not only EtherCAT devices (or Ethernet ports that are usable as such), but also NOVRAM, fieldbus cards, SMB etc. However, not all devices can be found automatically.

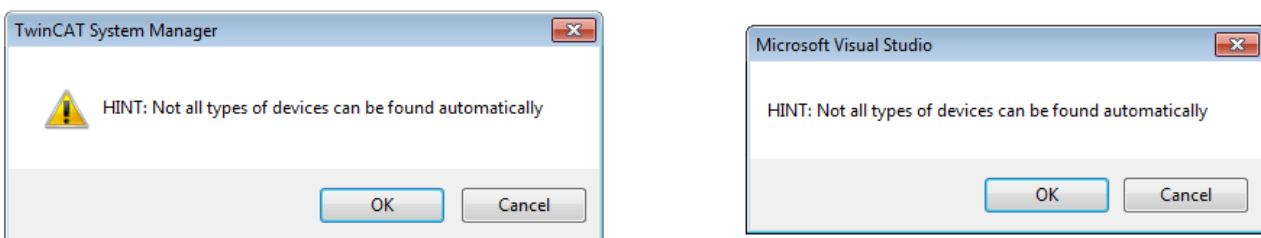

Fig. 92: Note for automatic device scan (left: TwinCAT 2; right: TwinCAT 3)

Ethernet ports with installed TwinCAT real-time driver are shown as “RT Ethernet” devices. An EtherCAT frame is sent to these ports for testing purposes. If the scan agent detects from the response that an EtherCAT slave is connected, the port is immediately shown as an “EtherCAT Device” .

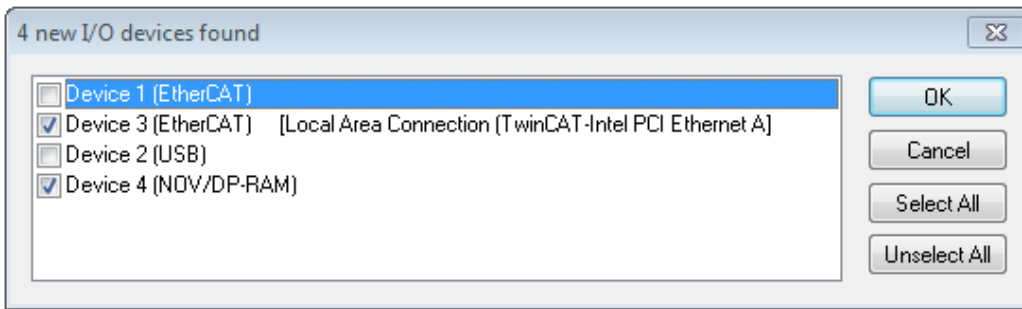

Fig. 93: *Detected Ethernet devices*

Via respective checkboxes devices can be selected (as illustrated in Fig. “*Detected Ethernet devices*” e.g. Device 3 and Device 4 were chosen). After confirmation with “OK” a device scan is suggested for all selected devices, see Fig.: “*Scan query after automatic creation of an EtherCAT device*”.

● Selecting the Ethernet port



Ethernet ports can only be selected for EtherCAT devices for which the TwinCAT real-time driver is installed. This has to be done separately for each port. Please refer to the respective [installation page](#) [▶ 59].

Detecting/Scanning the EtherCAT devices

● Online scan functionality



During a scan the master queries the identity information of the EtherCAT slaves from the slave EEPROM. The name and revision are used for determining the type. The respective devices are located in the stored ESI data and integrated in the configuration tree in the default state defined there.

Name
(EL2521-0025-1018)
Revision

Fig. 94: *Example default state*

NOTE

Slave scanning in practice in series machine production

The scanning function should be used with care. It is a practical and fast tool for creating an initial configuration as a basis for commissioning. In series machine production or reproduction of the plant, however, the function should no longer be used for the creation of the configuration, but if necessary for [comparison](#) [▶ 80] with the defined initial configuration. Background: since Beckhoff occasionally increases the revision version of the delivered products for product maintenance reasons, a configuration can be created by such a scan which (with an identical machine construction) is identical according to the device list; however, the respective device revision may differ from the initial configuration.

Example:

Company A builds the prototype of a machine B, which is to be produced in series later on. To do this the prototype is built, a scan of the IO devices is performed in TwinCAT and the initial configuration ‘B.tsm’ is created. The EL2521-0025 EtherCAT terminal with the revision 1018 is located somewhere. It is thus built into the TwinCAT configuration in this way:

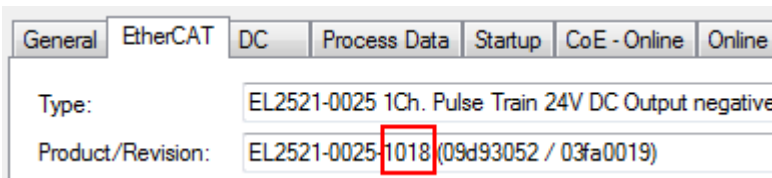

Fig. 95: Installing EthetCAT terminal with revision -1018

Likewise, during the prototype test phase, the functions and properties of this terminal are tested by the programmers/commissioning engineers and used if necessary, i.e. addressed from the PLC 'B.pro' or the NC. (the same applies correspondingly to the TwinCAT 3 solution files).

The prototype development is now completed and series production of machine B starts, for which Beckhoff continues to supply the EL2521-0025-0018. If the commissioning engineers of the series machine production department always carry out a scan, a B configuration with the identical contents results again for each machine. Likewise, A might create spare parts stores worldwide for the coming series-produced machines with EL2521-0025-1018 terminals.

After some time Beckhoff extends the EL2521-0025 by a new feature C. Therefore the FW is changed, outwardly recognizable by a higher FW version and a **new revision -1019**. Nevertheless the new device naturally supports functions and interfaces of the predecessor version(s); an adaptation of 'B.tsm' or even 'B.pro' is therefore unnecessary. The series-produced machines can continue to be built with 'B.tsm' and 'B.pro'; it makes sense to perform a comparative scan [▶ 80](#) against the initial configuration 'B.tsm' in order to check the built machine.

However, if the series machine production department now doesn't use 'B.tsm', but instead carries out a scan to create the productive configuration, the revision **-1019** is automatically detected and built into the configuration:

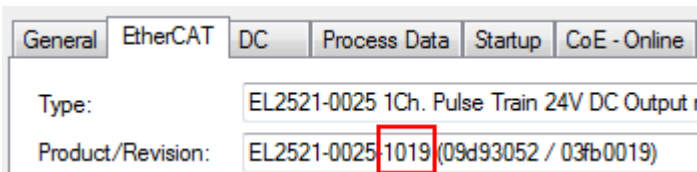

Fig. 96: Detection of EtherCAT terminal with revision -1019

This is usually not noticed by the commissioning engineers. TwinCAT cannot signal anything either, since virtually a new configuration is created. According to the compatibility rule, however, this means that no EL2521-0025-**1018** should be built into this machine as a spare part (even if this nevertheless works in the vast majority of cases).

In addition, it could be the case that, due to the development accompanying production in company A, the new feature C of the EL2521-0025-1019 (for example, an improved analog filter or an additional process data for the diagnosis) is discovered and used without in-house consultation. The previous stock of spare part devices are then no longer to be used for the new configuration 'B2.tsm' created in this way. If series machine production is established, the scan should only be performed for informative purposes for comparison with a defined initial configuration. Changes are to be made with care!

If an EtherCAT device was created in the configuration (manually or through a scan), the I/O field can be scanned for devices/slaves.



Fig. 97: Scan query after automatic creation of an EtherCAT device (left: TwinCAT 2; right: TwinCAT 3)

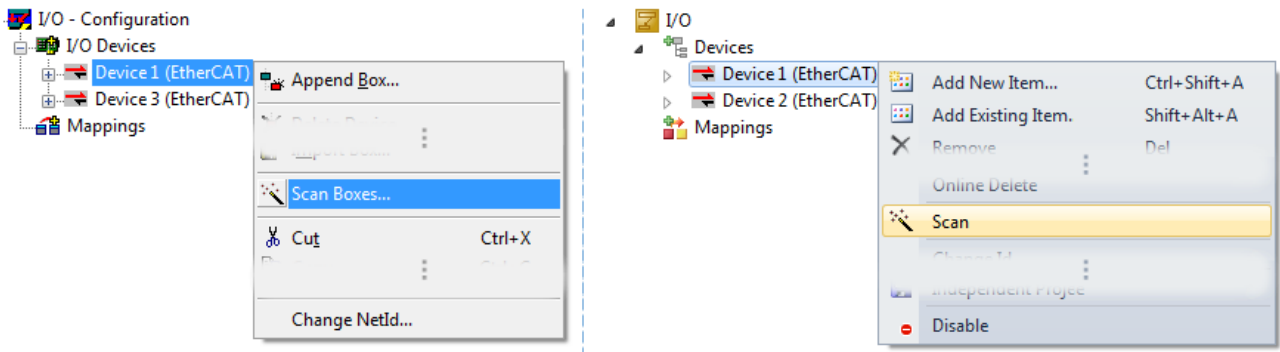

Fig. 98: Manual triggering of a device scan on a specified EtherCAT device (left: TwinCAT 2; right: TwinCAT 3)

In the System Manager (TwinCAT 2) or the User Interface (TwinCAT 3) the scan process can be monitored via the progress bar at the bottom in the status bar.



Fig. 99: Scan progress exemplarily by TwinCAT 2

The configuration is established and can then be switched to online state (OPERATIONAL).



Fig. 100: Config/FreeRun query (left: TwinCAT 2; right: TwinCAT 3)

In Config/FreeRun mode the System Manager display alternates between blue and red, and the EtherCAT device continues to operate with the idling cycle time of 4 ms (default setting), even without active task (NC, PLC).



Fig. 101: Displaying of “Free Run” and “Config Mode” toggling right below in the status bar



Fig. 102: TwinCAT can also be switched to this state by using a button (left: TwinCAT 2; right: TwinCAT 3)

The EtherCAT system should then be in a functional cyclic state, as shown in Fig. “Online display example”.

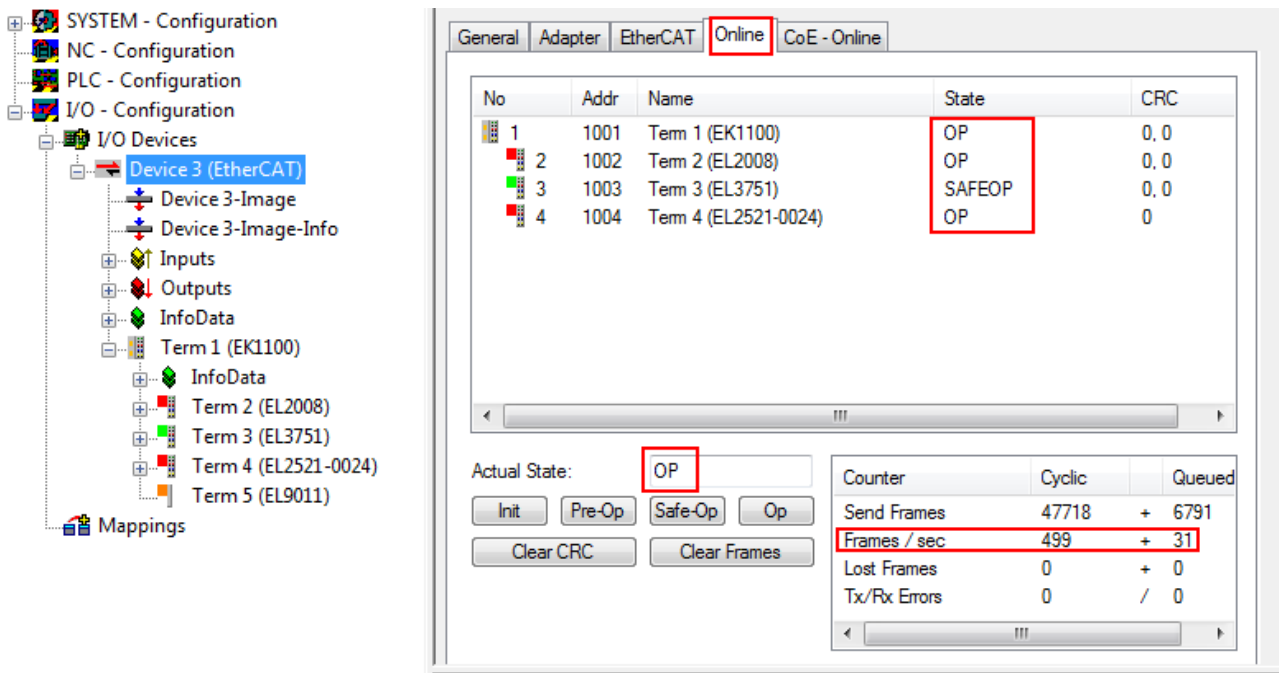

Fig. 103: Online display example

Please note:

- all slaves should be in OP state
- the EtherCAT master should be in “Actual State” OP
- “frames/sec” should match the cycle time taking into account the sent number of frames
- no excessive “LostFrames” or CRC errors should occur

The configuration is now complete. It can be modified as described under [manual procedure \[► 70\]](#).

Troubleshooting

Various effects may occur during scanning.

- An **unknown device** is detected, i.e. an EtherCAT slave for which no ESI XML description is available. In this case the System Manager offers to read any ESI that may be stored in the device. This case is described in the chapter "Notes regarding ESI device description".
- **Device are not detected properly**
Possible reasons include:
 - faulty data links, resulting in data loss during the scan
 - slave has invalid device description
 The connections and devices should be checked in a targeted manner, e.g. via the emergency scan. Then re-run the scan.

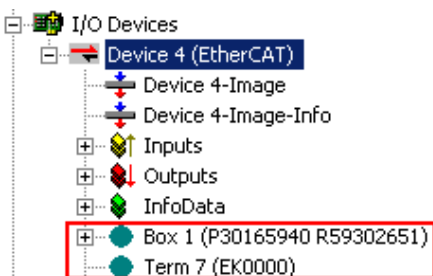

Fig. 104: Faulty identification

In the System Manager such devices may be set up as EK0000 or unknown devices. Operation is not possible or meaningful.

Scan over existing Configuration

NOTE

Change of the configuration after comparison

With this scan (TwinCAT 2.11 or 3.1) only the device properties vendor (manufacturer), device name and revision are compared at present! A 'ChangeTo' or 'Copy' should only be carried out with care, taking into consideration the Beckhoff IO compatibility rule (see above). The device configuration is then replaced by the revision found; this can affect the supported process data and functions.

If a scan is initiated for an existing configuration, the actual I/O environment may match the configuration exactly or it may differ. This enables the configuration to be compared.



Fig. 105: Identical configuration (left: TwinCAT 2; right: TwinCAT 3)

If differences are detected, they are shown in the correction dialog, so that the user can modify the configuration as required.

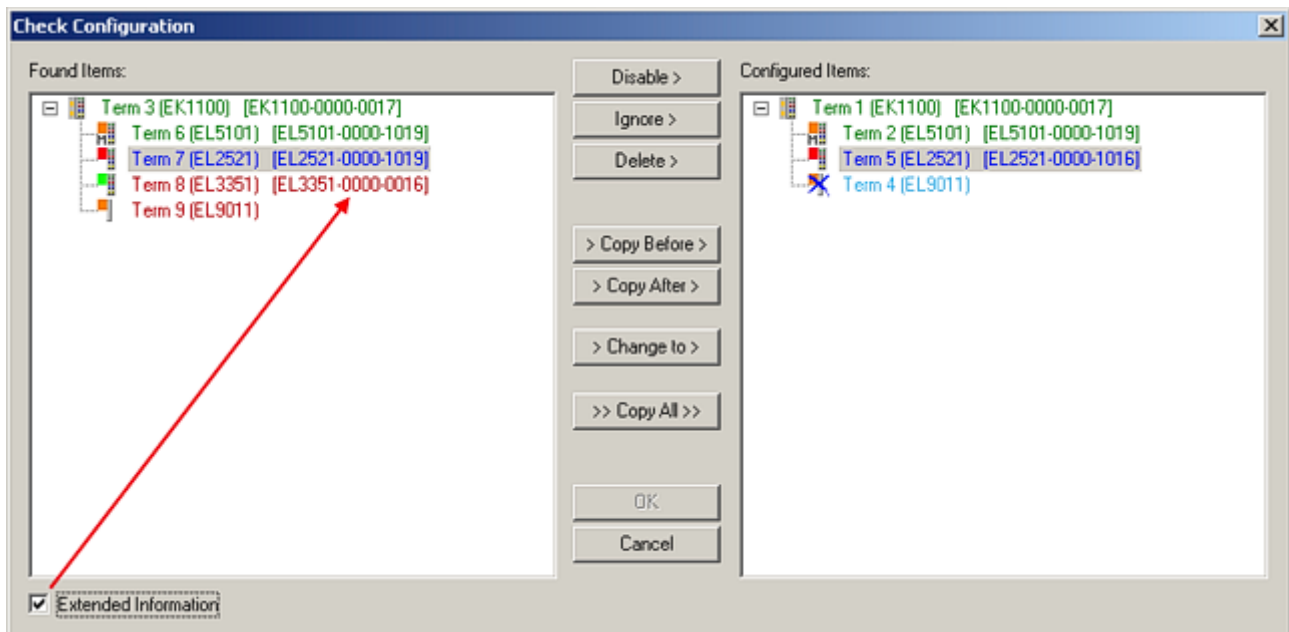

Fig. 106: Correction dialog

It is advisable to tick the “Extended Information” check box to reveal differences in the revision.

Colour	Explanation
green	This EtherCAT slave matches the entry on the other side. Both type and revision match.
blue	This EtherCAT slave is present on the other side, but in a different revision. This other revision can have other default values for the process data as well as other/additional functions. If the found revision is higher than the configured revision, the slave may be used provided compatibility issues are taken into account. If the found revision is lower than the configured revision, it is likely that the slave cannot be used. The found device may not support all functions that the master expects based on the higher revision number.
light blue	This EtherCAT slave is ignored ("Ignore" button)
red	<ul style="list-style-type: none"> This EtherCAT slave is not present on the other side. It is present, but in a different revision, which also differs in its properties from the one specified. The compatibility principle then also applies here: if the found revision is higher than the configured revision, use is possible provided compatibility issues are taken into account, since the successor devices should support the functions of the predecessor devices. If the found revision is lower than the configured revision, it is likely that the slave cannot be used. The found device may not support all functions that the master expects based on the higher revision number.

● Device selection based on revision, compatibility

i The ESI description also defines the process image, the communication type between master and slave/device and the device functions, if applicable. The physical device (firmware, if available) has to support the communication queries/settings of the master. This is backward compatible, i.e. newer devices (higher revision) should be supported if the EtherCAT master addresses them as an older revision. The following compatibility rule of thumb is to be assumed for Beckhoff EtherCAT Terminals/ Boxes/ EJ-modules:

device revision in the system >= device revision in the configuration

This also enables subsequent replacement of devices without changing the configuration (different specifications are possible for drives).

Example:

If an EL2521-0025-**1018** is specified in the configuration, an EL2521-0025-**1018** or higher (**-1019**, **-1020**) can be used in practice.

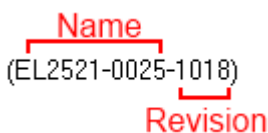

Fig. 107: Name/revision of the terminal

If current ESI descriptions are available in the TwinCAT system, the last revision offered in the selection dialog matches the Beckhoff state of production. It is recommended to use the last device revision when creating a new configuration, if current Beckhoff devices are used in the real application. Older revisions should only be used if older devices from stock are to be used in the application.

In this case the process image of the device is shown in the configuration tree and can be parameterised as follows: linking with the task, CoE/DC settings, plug-in definition, startup settings, ...

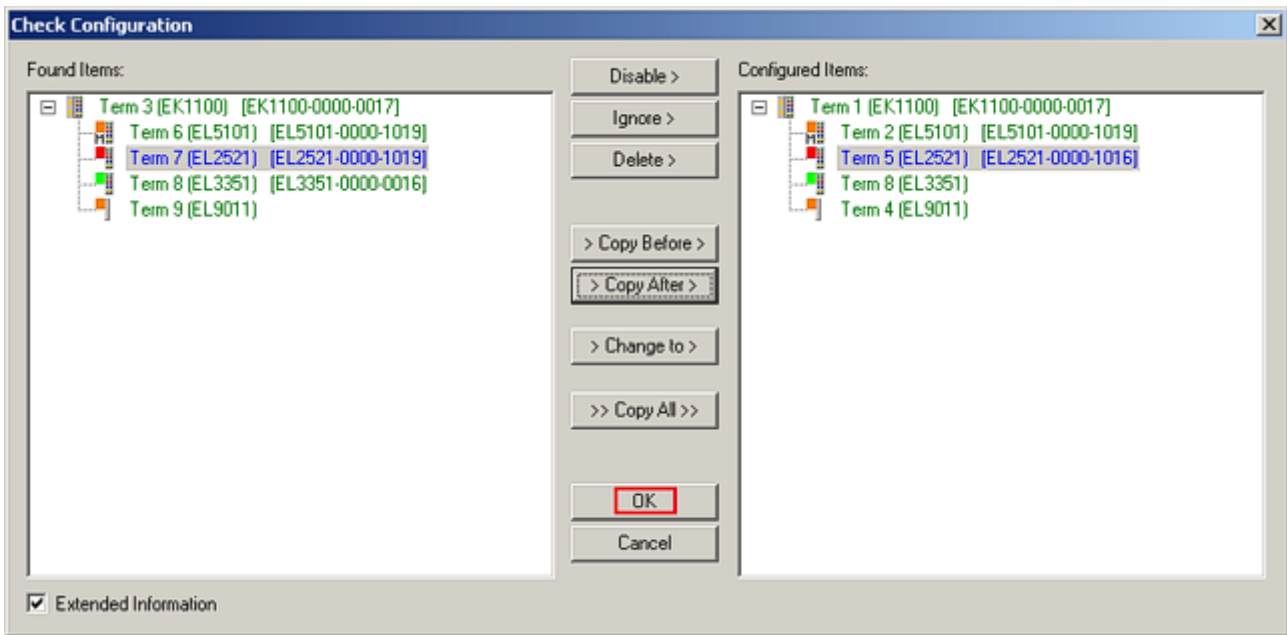

Fig. 108: Correction dialog with modifications

Once all modifications have been saved or accepted, click “OK” to transfer them to the real *.tsm configuration.

Change to Compatible Type

TwinCAT offers a function “Change to Compatible Type...” for the exchange of a device whilst retaining the links in the task.

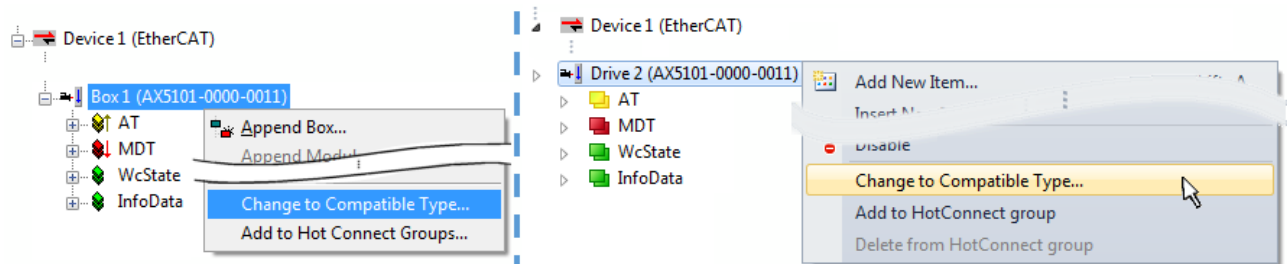

Fig. 109: Dialog “Change to Compatible Type...” (left: TwinCAT 2; right: TwinCAT 3)

This function is preferably to be used on AX5000 devices.

Change to Alternative Type

The TwinCAT System Manager offers a function for the exchange of a device: *Change to Alternative Type*

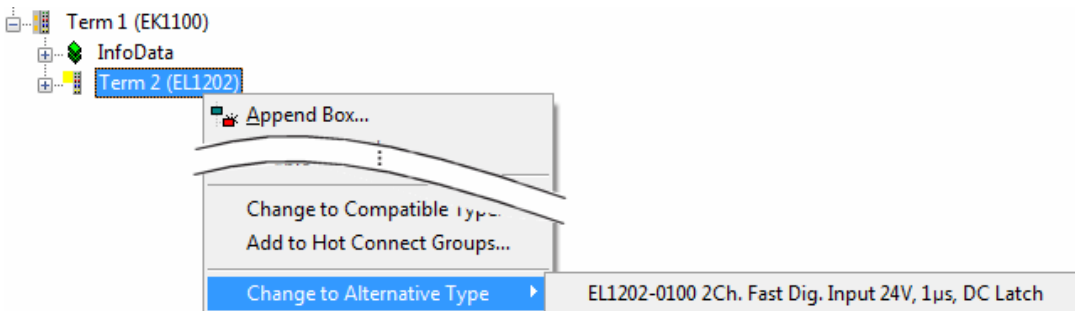

Fig. 110: TwinCAT 2 Dialog Change to Alternative Type

If called, the System Manager searches in the procured device ESI (in this example: EL1202-0000) for details of compatible devices contained there. The configuration is changed and the ESI-EEPROM is overwritten at the same time – therefore this process is possible only in the online state (ConfigMode).

6.2.7 EtherCAT subscriber configuration

In the left-hand window of the TwinCAT 2 System Manager or the Solution Explorer of the TwinCAT 3 Development Environment respectively, click on the element of the terminal within the tree you wish to configure (in the example: EL3751 Terminal 3).

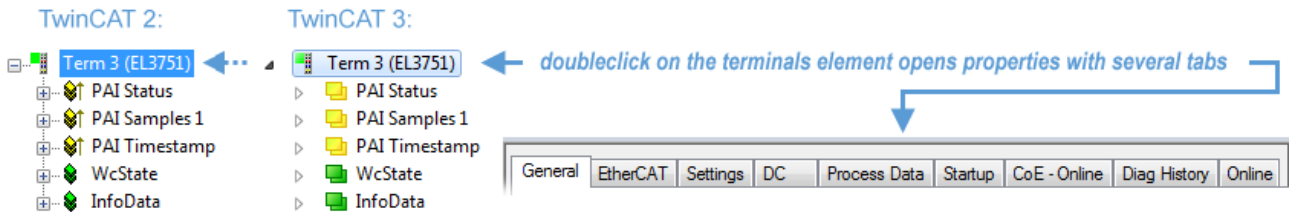

Fig. 111: Branch element as terminal EL3751

In the right-hand window of the TwinCAT System manager (TwinCAT 2) or the Development Environment (TwinCAT 3), various tabs are now available for configuring the terminal. And yet the dimension of complexity of a subscriber determines which tabs are provided. Thus as illustrated in the example above the terminal EL3751 provides many setup options and also a respective number of tabs are available. On the contrary by the terminal EL1004 for example the tabs "General", "EtherCAT", "Process Data" and "Online" are available only. Several terminals, as for instance the EL6695 provide special functions by a tab with its own terminal name, so "EL6695" in this case. A specific tab "Settings" by terminals with a wide range of setup options will be provided also (e.g. EL3751).

„General“ tab

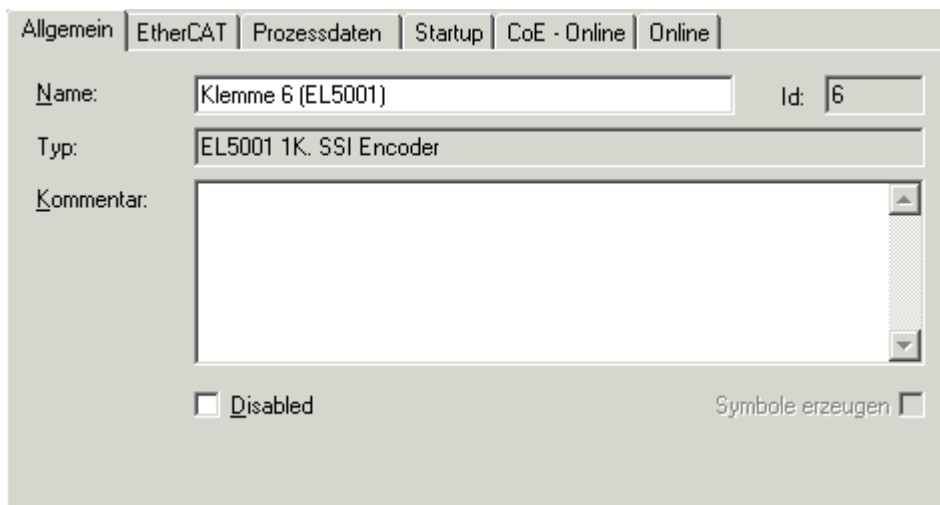

Fig. 112: "General" tab

Name	Name of the EtherCAT device
Id	Number of the EtherCAT device
Type	EtherCAT device type
Comment	Here you can add a comment (e.g. regarding the system).
Disabled	Here you can deactivate the EtherCAT device.
Create symbols	Access to this EtherCAT slave via ADS is only available if this control box is activated.

„EtherCAT“ tab

Fig. 113: „EtherCAT“ tab

Type	EtherCAT device type
Product/Revision	Product and revision number of the EtherCAT device
Auto Inc Addr.	Auto increment address of the EtherCAT device. The auto increment address can be used for addressing each EtherCAT device in the communication ring through its physical position. Auto increment addressing is used during the start-up phase when the EtherCAT master allocates addresses to the EtherCAT devices. With auto increment addressing the first EtherCAT slave in the ring has the address 0000 _{hex} . For each further slave the address is decremented by 1 (FFFF _{hex} , FFFE _{hex} etc.).
EtherCAT Addr.	Fixed address of an EtherCAT slave. This address is allocated by the EtherCAT master during the start-up phase. Tick the control box to the left of the input field in order to modify the default value.
Previous Port	Name and port of the EtherCAT device to which this device is connected. If it is possible to connect this device with another one without changing the order of the EtherCAT devices in the communication ring, then this combination field is activated and the EtherCAT device to which this device is to be connected can be selected.
Advanced Settings	This button opens the dialogs for advanced settings.

The link at the bottom of the tab points to the product page for this EtherCAT device on the web.

“Process Data” tab

Indicates the configuration of the process data. The input and output data of the EtherCAT slave are represented as CANopen process data objects (**P**rocess **D**ata **O**bjects, PDOs). The user can select a PDO via PDO assignment and modify the content of the individual PDO via this dialog, if the EtherCAT slave supports this function.

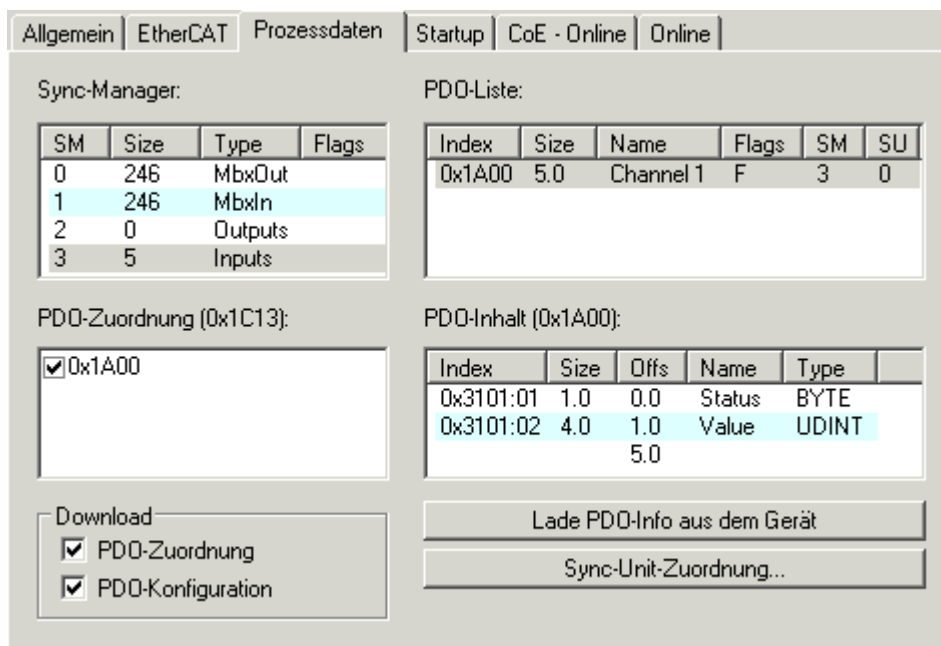

Fig. 114: "Process Data" tab

The process data (PDOs) transferred by an EtherCAT slave during each cycle are user data which the application expects to be updated cyclically or which are sent to the slave. To this end the EtherCAT master (Beckhoff TwinCAT) parameterizes each EtherCAT slave during the start-up phase to define which process data (size in bits/bytes, source location, transmission type) it wants to transfer to or from this slave. Incorrect configuration can prevent successful start-up of the slave.

For Beckhoff EtherCAT EL, ES, EM, EJ and EP slaves the following applies in general:

- The input/output process data supported by the device are defined by the manufacturer in the ESI/XML description. The TwinCAT EtherCAT Master uses the ESI description to configure the slave correctly.
- The process data can be modified in the system manager. See the device documentation. Examples of modifications include: mask out a channel, displaying additional cyclic information, 16-bit display instead of 8-bit data size, etc.
- In so-called "intelligent" EtherCAT devices the process data information is also stored in the CoE directory. Any changes in the CoE directory that lead to different PDO settings prevent successful startup of the slave. It is not advisable to deviate from the designated process data, because the device firmware (if available) is adapted to these PDO combinations.

If the device documentation allows modification of process data, proceed as follows (see Figure "Configuring the process data").

- A: select the device to configure
- B: in the "Process Data" tab select Input or Output under SyncManager (C)
- D: the PDOs can be selected or deselected
- H: the new process data are visible as linkable variables in the system manager
The new process data are active once the configuration has been activated and TwinCAT has been restarted (or the EtherCAT master has been restarted)
- E: if a slave supports this, Input and Output PDO can be modified simultaneously by selecting a so-called PDO record ("predefined PDO settings").

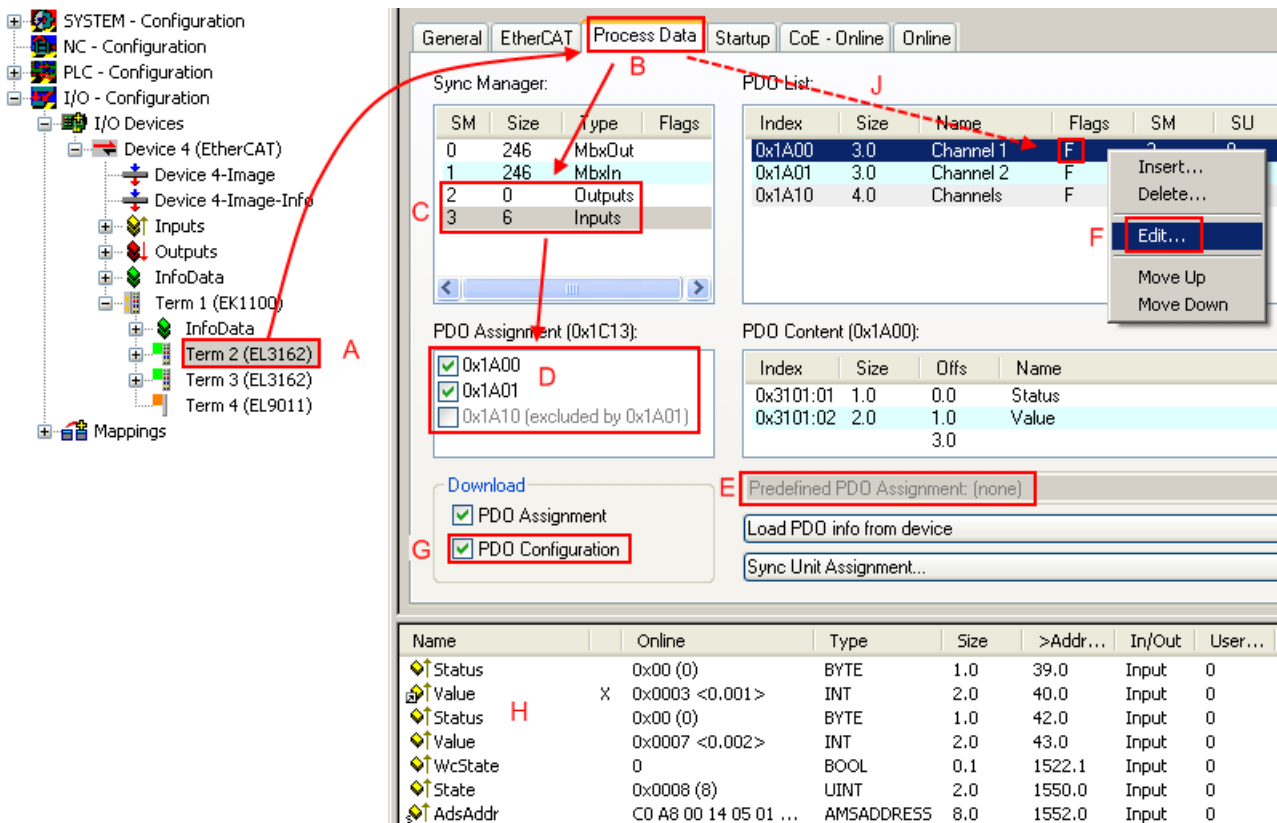

Fig. 115: Configuring the process data

i Manual modification of the process data

According to the ESI description, a PDO can be identified as “fixed” with the flag “F” in the PDO overview (Fig. “Configuring the process data”, J). The configuration of such PDOs cannot be changed, even if TwinCAT offers the associated dialog (“Edit”). In particular, CoE content cannot be displayed as cyclic process data. This generally also applies in cases where a device supports download of the PDO configuration, “G”. In case of incorrect configuration the EtherCAT slave usually refuses to start and change to OP state. The System Manager displays an “invalid SM cfg” log-ger message: This error message (“invalid SM IN cfg” or “invalid SM OUT cfg”) also indicates the reason for the failed start.

A detailed description [► 91] can be found at the end of this section.

„Startup“ tab

The *Startup* tab is displayed if the EtherCAT slave has a mailbox and supports the *CANopen over EtherCAT* (CoE) or *Servo drive over EtherCAT* protocol. This tab indicates which download requests are sent to the mailbox during startup. It is also possible to add new mailbox requests to the list display. The download requests are sent to the slave in the same order as they are shown in the list.

Index	Name	Flags	Wert
1000	Device type	RO	0x00000000 (0)
1008	Device name	RO	EL5001-0000
1009	Hardware version	RO	V00.01
100A	Software version	RO	V00.07
1011:0	Restore default parame...	RW	> 1 <
1011:01	Restore all	RW	0
1018:0	Identity object	RO	> 4 <
1018:01	Vendor id	RO	0x00000002 (2)
1018:02	Product code	RO	0x13893052 (327757906)
1018:03	Revision number	RO	0x00000000 (0)
1018:04	Serial number	RO	0x00000001 (1)
1A00:0	TxPDO 001 mapping	RO	> 2 <
1A00:01	Subindex 001	RO	0x3101:01, 8
1A00:02	Subindex 002	RO	0x3101:02, 32
1C00:0	SM type	RO	> 4 <
1C00:01	Subindex 001	RO	0x01 (1)
1C00:02	Subindex 002	RO	0x02 (2)
1C00:03	Subindex 003	RO	0x03 (3)
1C00:04	Subindex 004	RO	0x04 (4)
1C13:0	SM 3 PDO assign (inputs)	RW	> 1 <
1C13:01	Subindex 001	RW	0x1A00 (6656)
3101:0	Inputs	RO P	> 2 <
3101:01	Status	RO P	0x41 (65)
3101:02	Value	RO P	0x00000000 (0)
4061:0	Feature bits	RW	> 4 <
4061:01	disable frame error	RW	FALSE
4061:02	enable power failure Bit	RW	FALSE
4061:03	enable inhibit time	RW	FALSE
4061:04	enable test mode	RW	FALSE
4066	SSI-coding	RW	Gray code (1)
4067	SSI-baudrate	RW	500 kBaud (3)
4068	SSI-frame type	RW	Multiturn 25 bit (0)
4069	SSI-frame size	RW	0x0019 (25)
406A	Data length	RW	0x0018 (24)
406B	Min. inhibit time[μs]	RW	0x0000 (0)

Fig. 117: "CoE – Online" tab

Object list display

Column	Description	
Index	Index and sub-index of the object	
Name	Name of the object	
Flags	RW	The object can be read, and data can be written to the object (read/write)
	RO	The object can be read, but no data can be written to the object (read only)
	P	An additional P identifies the object as a process data object.
Value	Value of the object	

Update List

The *Update list* button updates all objects in the displayed list

Auto Update

If this check box is selected, the content of the objects is updated automatically.

Advanced

The *Advanced* button opens the *Advanced Settings* dialog. Here you can specify which objects are displayed in the list.

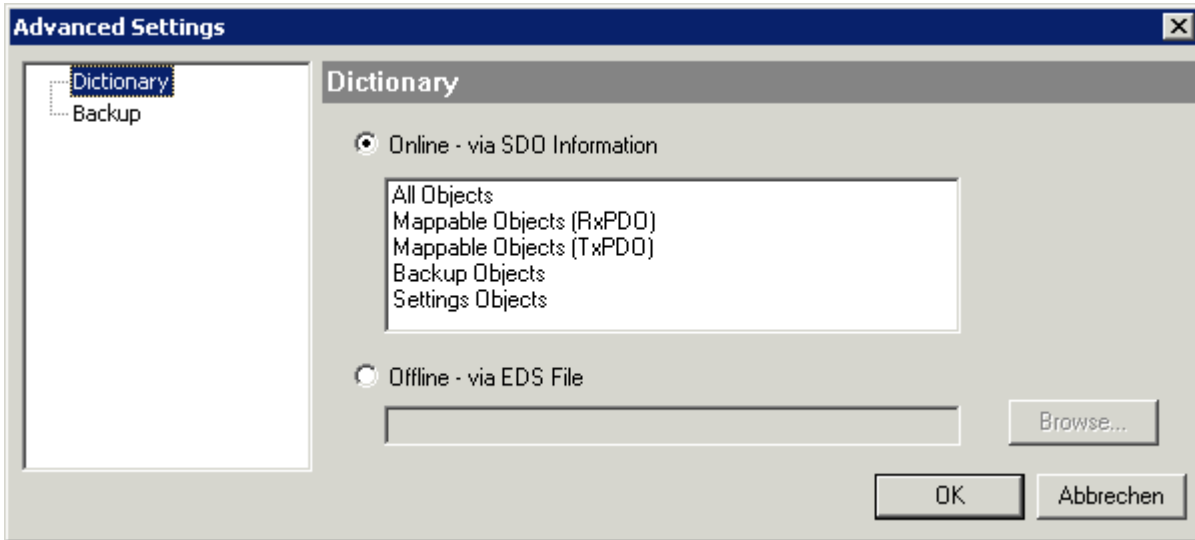

Fig. 118: Dialog “Advanced settings”

<p>Online - via SDO Information</p>	<p>If this option button is selected, the list of the objects included in the object list of the slave is uploaded from the slave via SDO information. The list below can be used to specify which object types are to be uploaded.</p>
<p>Offline - via EDS File</p>	<p>If this option button is selected, the list of the objects included in the object list is read from an EDS file provided by the user.</p>

„Online“ tab

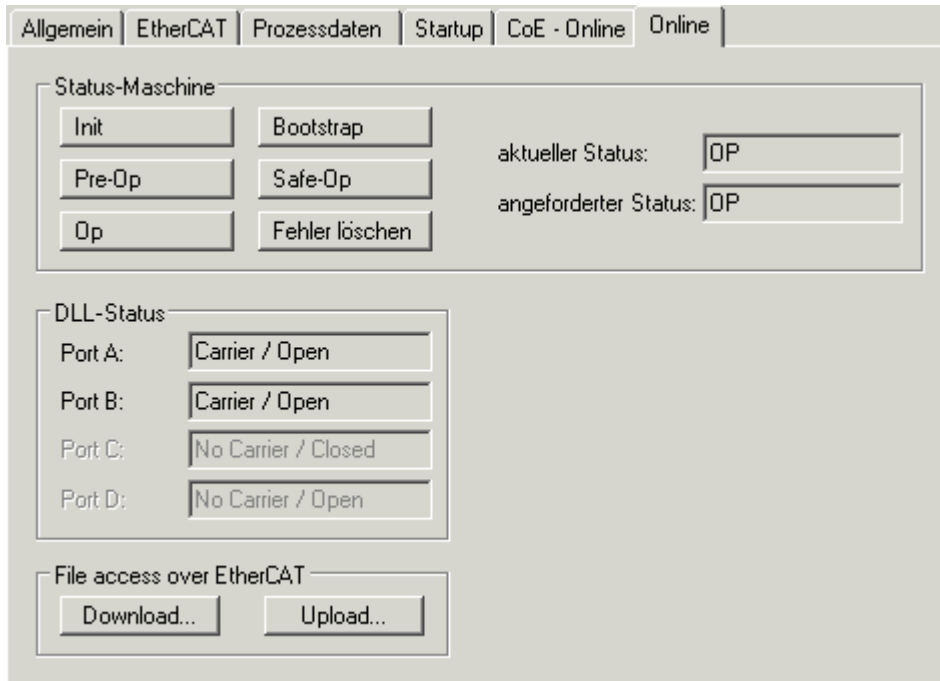

Fig. 119: „Online“ tab

State Machine**Init**

This button attempts to set the EtherCAT device to the *Init* state.

Pre-Op

This button attempts to set the EtherCAT device to the *pre-operational* state.

Op

This button attempts to set the EtherCAT device to the *operational* state.

Bootstrap

This button attempts to set the EtherCAT device to the *Bootstrap* state.

Safe-Op

This button attempts to set the EtherCAT device to the *safe-operational* state.

Clear Error

This button attempts to delete the fault display. If an EtherCAT slave fails during change of state it sets an error flag.

Example: An EtherCAT slave is in PREOP state (pre-operational). The master now requests the SAFEOP state (safe-operational). If the slave fails during change of state it sets the error flag. The current state is now displayed as ERR PREOP. When the *Clear Error* button is pressed the error flag is cleared, and the current state is displayed as PREOP again.

Current State

Indicates the current state of the EtherCAT device.

Requested State

Indicates the state requested for the EtherCAT device.

DLL Status

Indicates the DLL status (data link layer status) of the individual ports of the EtherCAT slave. The DLL status can have four different states:

Status	Description
No Carrier / Open	No carrier signal is available at the port, but the port is open.
No Carrier / Closed	No carrier signal is available at the port, and the port is closed.
Carrier / Open	A carrier signal is available at the port, and the port is open.
Carrier / Closed	A carrier signal is available at the port, but the port is closed.

File Access over EtherCAT

Download

With this button a file can be written to the EtherCAT device.

Upload

With this button a file can be read from the EtherCAT device.

"DC" tab (Distributed Clocks)

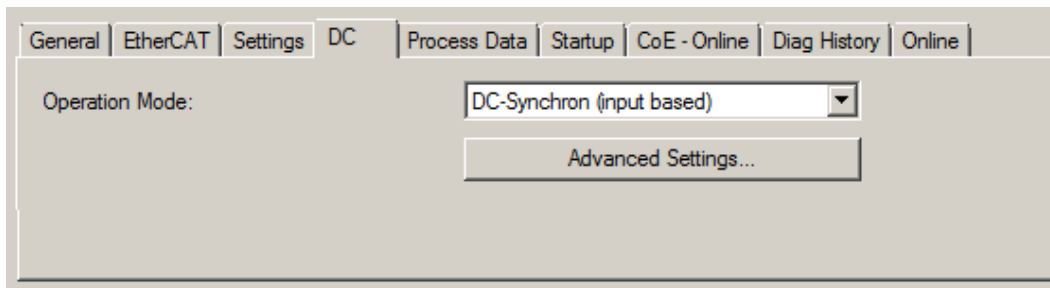

Fig. 120: "DC" tab (Distributed Clocks)

Operation Mode

Options (optional):

- FreeRun
- SM-Synchron
- DC-Synchron (Input based)
- DC-Synchron

Advanced Settings...

Advanced settings for readjustment of the real time determinant TwinCAT-clock

Detailed information to Distributed Clocks are specified on <http://infosys.beckhoff.com>:

Fieldbus Components → EtherCAT Terminals → EtherCAT System documentation → EtherCAT basics → Distributed Clocks

6.2.7.1 Detailed description of Process Data tab

Sync Manager

Lists the configuration of the Sync Manager (SM).

If the EtherCAT device has a mailbox, SM0 is used for the mailbox output (MbxOut) and SM1 for the mailbox input (MbxIn).

SM2 is used for the output process data (outputs) and SM3 (inputs) for the input process data.

If an input is selected, the corresponding PDO assignment is displayed in the *PDO Assignment* list below.

PDO Assignment

PDO assignment of the selected Sync Manager. All PDOs defined for this Sync Manager type are listed here:

- If the output Sync Manager (outputs) is selected in the Sync Manager list, all RxPDOs are displayed.
- If the input Sync Manager (inputs) is selected in the Sync Manager list, all TxPDOs are displayed.

The selected entries are the PDOs involved in the process data transfer. In the tree diagram of the System Manager these PDOs are displayed as variables of the EtherCAT device. The name of the variable is identical to the *Name* parameter of the PDO, as displayed in the PDO list. If an entry in the PDO assignment list is deactivated (not selected and greyed out), this indicates that the input is excluded from the PDO assignment. In order to be able to select a greyed out PDO, the currently selected PDO has to be deselected first.

● **Activation of PDO assignment**



- ✓ If you have changed the PDO assignment, in order to activate the new PDO assignment,
 - a) the EtherCAT slave has to run through the PS status transition cycle (from pre-operational to safe-operational) once (see [Online tab \[▶ 90\]](#)),
 - b) and the System Manager has to reload the EtherCAT slaves



(button for TwinCAT 2 or  button for TwinCAT 3)

PDO list

List of all PDOs supported by this EtherCAT device. The content of the selected PDOs is displayed in the *PDO Content* list. The PDO configuration can be modified by double-clicking on an entry.

Column	Description	
Index	PDO index.	
Size	Size of the PDO in bytes.	
Name	Name of the PDO. If this PDO is assigned to a Sync Manager, it appears as a variable of the slave with this parameter as the name.	
Flags	F	Fixed content: The content of this PDO is fixed and cannot be changed by the System Manager.
	M	Mandatory PDO. This PDO is mandatory and must therefore be assigned to a Sync Manager! Consequently, this PDO cannot be deleted from the <i>PDO Assignment</i> list
SM	Sync Manager to which this PDO is assigned. If this entry is empty, this PDO does not take part in the process data traffic.	
SU	Sync unit to which this PDO is assigned.	

PDO Content

Indicates the content of the PDO. If flag F (fixed content) of the PDO is not set the content can be modified.

Download

If the device is intelligent and has a mailbox, the configuration of the PDO and the PDO assignments can be downloaded to the device. This is an optional feature that is not supported by all EtherCAT slaves.

PDO Assignment

If this check box is selected, the PDO assignment that is configured in the PDO Assignment list is downloaded to the device on startup. The required commands to be sent to the device can be viewed in the [Startup \[▶ 86\]](#) tab.

PDO Configuration

If this check box is selected, the configuration of the respective PDOs (as shown in the PDO list and the PDO Content display) is downloaded to the EtherCAT slave.

6.3 General Notes - EtherCAT Slave Application

This summary briefly deals with a number of aspects of EtherCAT Slave operation under TwinCAT. More detailed information on this may be found in the corresponding sections of, for instance, the EtherCAT System Documentation.

Diagnosis in real time: WorkingCounter, EtherCAT State and Status

Generally speaking an EtherCAT Slave provides a variety of diagnostic information that can be used by the controlling task.

This diagnostic information relates to differing levels of communication. It therefore has a variety of sources, and is also updated at various times.

Any application that relies on I/O data from a fieldbus being correct and up to date must make diagnostic access to the corresponding underlying layers. EtherCAT and the TwinCAT System Manager offer comprehensive diagnostic elements of this kind. Those diagnostic elements that are helpful to the controlling task for diagnosis that is accurate for the current cycle when in operation (not during commissioning) are discussed below.

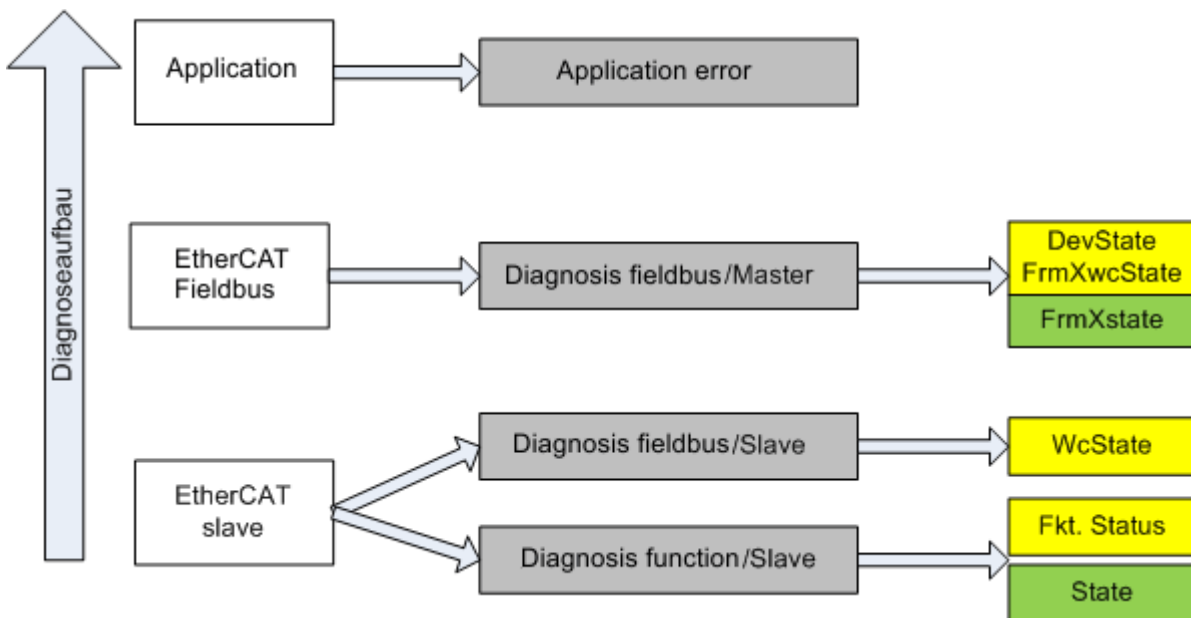

Fig. 121: Selection of the diagnostic information of an EtherCAT Slave

In general, an EtherCAT Slave offers

- communication diagnosis typical for a slave (diagnosis of successful participation in the exchange of process data, and correct operating mode)
This diagnosis is the same for all slaves.

as well as

- function diagnosis typical for a channel (device-dependent)
See the corresponding device documentation

The colors in Fig. “Selection of the diagnostic information of an EtherCAT Slave” also correspond to the variable colors in the System Manager, see Fig. “Basic EtherCAT Slave Diagnosis in the PLC”.

Colour	Meaning
yellow	Input variables from the Slave to the EtherCAT Master, updated in every cycle
red	Output variables from the Slave to the EtherCAT Master, updated in every cycle
green	Information variables for the EtherCAT Master that are updated acyclically. This means that it is possible that in any particular cycle they do not represent the latest possible status. It is therefore useful to read such variables through ADS.

Fig. “Basic EtherCAT Slave Diagnosis in the PLC” shows an example of an implementation of basic EtherCAT Slave Diagnosis. A Beckhoff EL3102 (2-channel analogue input terminal) is used here, as it offers both the communication diagnosis typical of a slave and the functional diagnosis that is specific to a channel. Structures are created as input variables in the PLC, each corresponding to the process image.

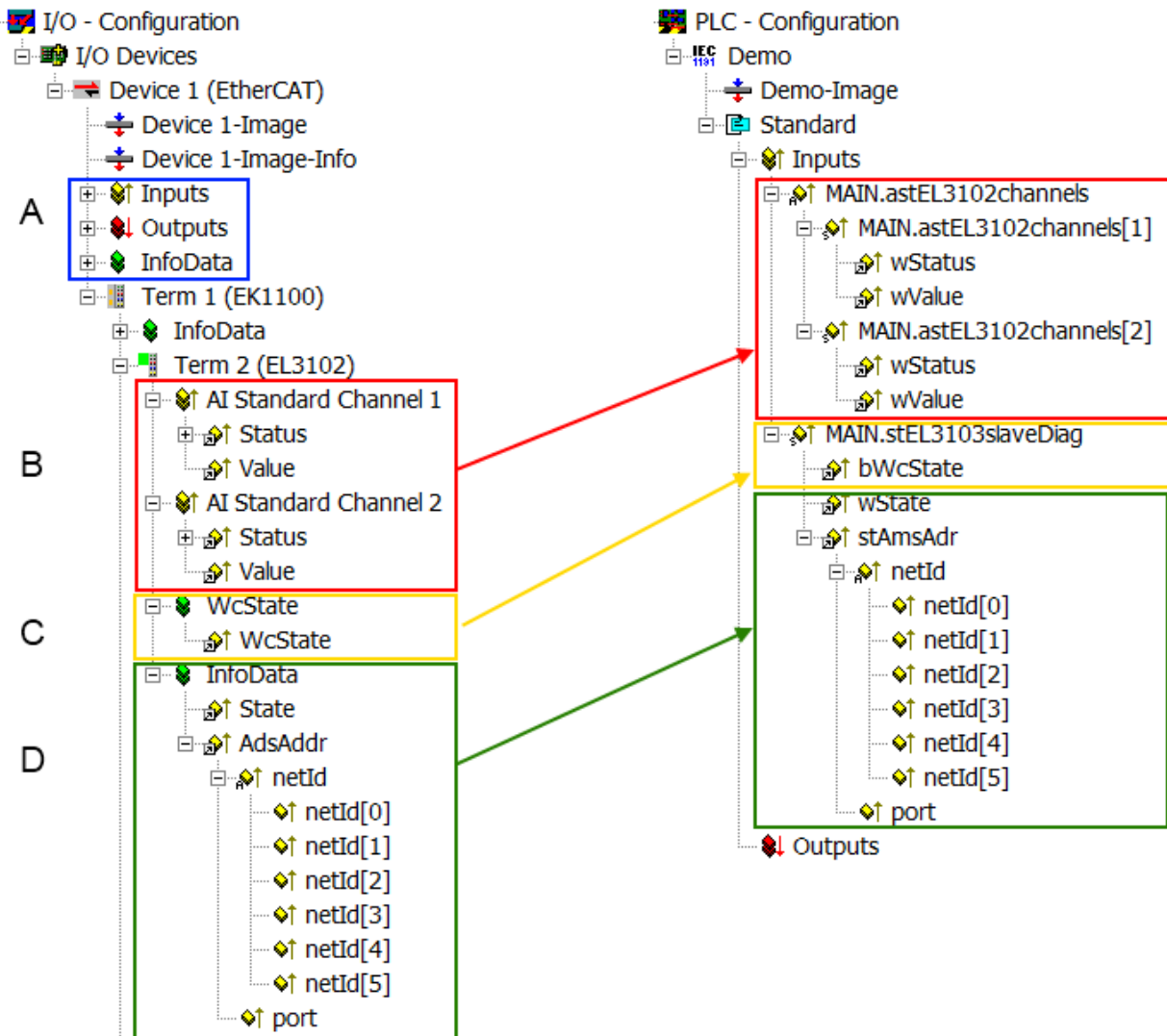

Fig. 122: Basic EtherCAT Slave Diagnosis in the PLC

The following aspects are covered here:

Code	Function	Implementation	Application/evaluation
A	The EtherCAT Master's diagnostic information updated acyclically (yellow) or provided acyclically (green).		At least the DevState is to be evaluated for the most recent cycle in the PLC. The EtherCAT Master's diagnostic information offers many more possibilities than are treated in the EtherCAT System Documentation. A few keywords: <ul style="list-style-type: none"> • CoE in the Master for communication with/through the Slaves • Functions from <i>TcEtherCAT.lib</i> • Perform an OnlineScan
B	In the example chosen (EL3102) the EL3102 comprises two analogue input channels that transmit a single function status for the most recent cycle.	Status <ul style="list-style-type: none"> • the bit significations may be found in the device documentation • other devices may supply more information, or none that is typical of a slave 	In order for the higher-level PLC task (or corresponding control applications) to be able to rely on correct data, the function status must be evaluated there. Such information is therefore provided with the process data for the most recent cycle.
C	For every EtherCAT Slave that has cyclic process data, the Master displays, using what is known as a WorkingCounter, whether the slave is participating successfully and without error in the cyclic exchange of process data. This important, elementary information is therefore provided for the most recent cycle in the System Manager <ol style="list-style-type: none"> 1. at the EtherCAT Slave, and, with identical contents 2. as a collective variable at the EtherCAT Master (see Point A) for linking.	WcState (Working Counter) 0: valid real-time communication in the last cycle 1: invalid real-time communication This may possibly have effects on the process data of other Slaves that are located in the same SyncUnit	In order for the higher-level PLC task (or corresponding control applications) to be able to rely on correct data, the communication status of the EtherCAT Slave must be evaluated there. Such information is therefore provided with the process data for the most recent cycle.
D	Diagnostic information of the EtherCAT Master which, while it is represented at the slave for linking, is actually determined by the Master for the Slave concerned and represented there. This information cannot be characterized as real-time, because it <ul style="list-style-type: none"> • is only rarely/never changed, except when the system starts up • is itself determined acyclically (e.g. EtherCAT Status) 	State current Status (INIT..OP) of the Slave. The Slave must be in OP (=8) when operating normally. <i>AdsAddr</i> The ADS address is useful for communicating from the PLC/task via ADS with the EtherCAT Slave, e.g. for reading/writing to the CoE. The AMS-NetID of a slave corresponds to the AMS-NetID of the EtherCAT Master; communication with the individual Slave is possible via the <i>port</i> (= EtherCAT address).	Information variables for the EtherCAT Master that are updated acyclically. This means that it is possible that in any particular cycle they do not represent the latest possible status. It is therefore possible to read such variables through ADS.

NOTE

Diagnostic information

It is strongly recommended that the diagnostic information made available is evaluated so that the application can react accordingly.

CoE Parameter Directory

The CoE parameter directory (CanOpen-over-EtherCAT) is used to manage the set values for the slave concerned. Changes may, in some circumstances, have to be made here when commissioning a relatively complex EtherCAT Slave. It can be accessed through the TwinCAT System Manager, see Fig. "EL3102, CoE directory".

Index	Name	Flags	Value
6010:0	AI Inputs Ch.2	RO	> 17 <
6401:0	Channels	RO	> 2 <
8000:0	AI Settings Ch.1	RW	> 24 <
8000:01	Enable user scale	RW	FALSE
8000:02	Presentation	RW	Signed (0)
8000:05	Siemens bits	RW	FALSE
8000:06	Enable filter	RW	FALSE
8000:07	Enable limit 1	RW	FALSE
8000:08	Enable limit 2	RW	FALSE
8000:0A	Enable user calibration	RW	FALSE
8000:0B	Enable vendor calibration	RW	TRUE

Fig. 123: EL3102, CoE directory

● EtherCAT System Documentation

i The comprehensive description in the [EtherCAT System Documentation](#) (EtherCAT Basics --> CoE Interface) must be observed!

A few brief extracts:

- Whether changes in the online directory are saved locally in the slave depends on the device. EL terminals (except the EL66xx) are able to save in this way.
- The user must manage the changes to the StartUp list.

Commissioning aid in the TwinCAT System Manager

Commissioning interfaces are being introduced as part of an ongoing process for EL/EP EtherCAT devices. These are available in TwinCAT System Managers from TwinCAT 2.11R2 and above. They are integrated into the System Manager through appropriately extended ESI configuration files.

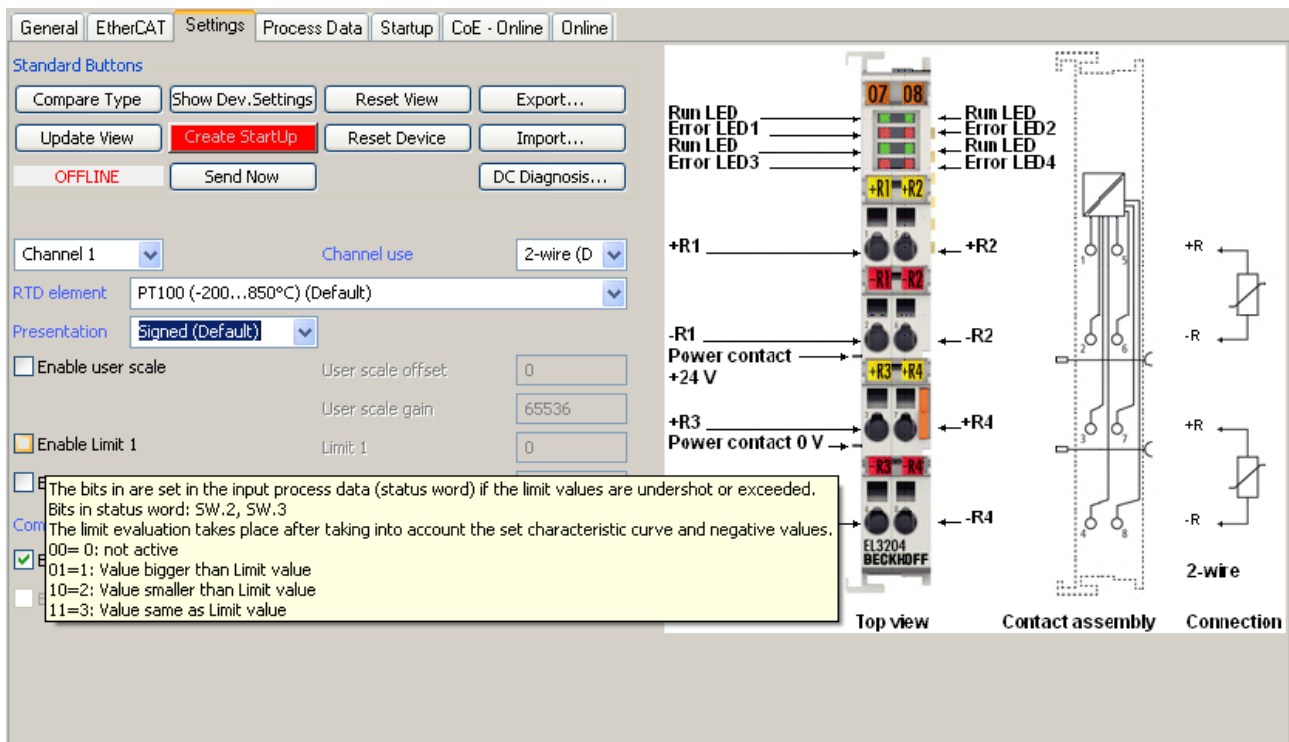

Fig. 124: Example of commissioning aid for a EL3204

This commissioning process simultaneously manages

- CoE Parameter Directory
- DC/FreeRun mode
- the available process data records (PDO)

Although the "Process Data", "DC", "Startup" and "CoE-Online" that used to be necessary for this are still displayed, it is recommended that, if the commissioning aid is used, the automatically generated settings are not changed by it.

The commissioning tool does not cover every possible application of an EL/EP device. If the available setting options are not adequate, the user can make the DC, PDO and CoE settings manually, as in the past.

EtherCAT State: automatic default behaviour of the TwinCAT System Manager and manual operation

After the operating power is switched on, an EtherCAT Slave must go through the following statuses

- INIT
- PREOP
- SAFEOP
- OP

to ensure sound operation. The EtherCAT Master directs these statuses in accordance with the initialization routines that are defined for commissioning the device by the ES/XML and user settings (Distributed Clocks (DC), PDO, CoE). See also the section on "Principles of [Communication, EtherCAT State Machine \[► 16\]](#)" in this connection. Depending how much configuration has to be done, and on the overall communication, booting can take up to a few seconds.

The EtherCAT Master itself must go through these routines when starting, until it has reached at least the OP target state.

The target state wanted by the user, and which is brought about automatically at start-up by TwinCAT, can be set in the System Manager. As soon as TwinCAT reaches the status RUN, the TwinCAT EtherCAT Master will approach the target states.

Standard setting

The advanced settings of the EtherCAT Master are set as standard:

- EtherCAT Master: OP
- Slaves: OP
This setting applies equally to all Slaves.

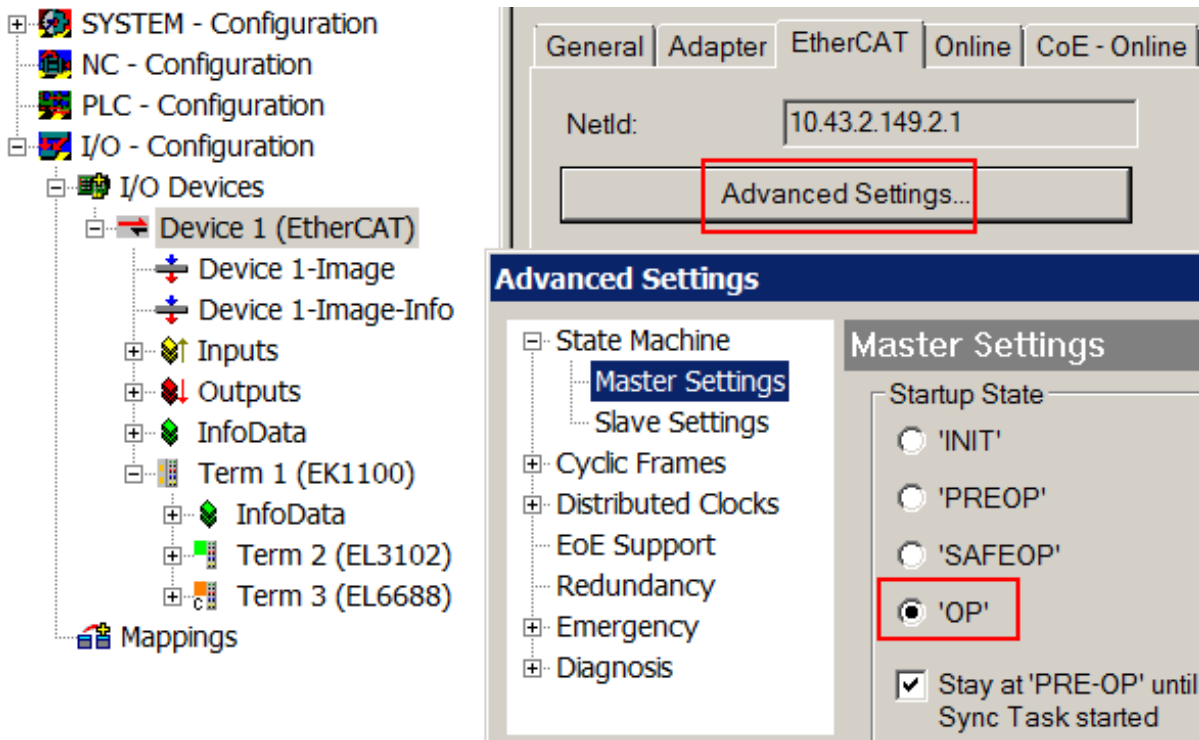

Fig. 125: Default behaviour of the System Manager

In addition, the target state of any particular Slave can be set in the "Advanced Settings" dialogue; the standard setting is again OP.

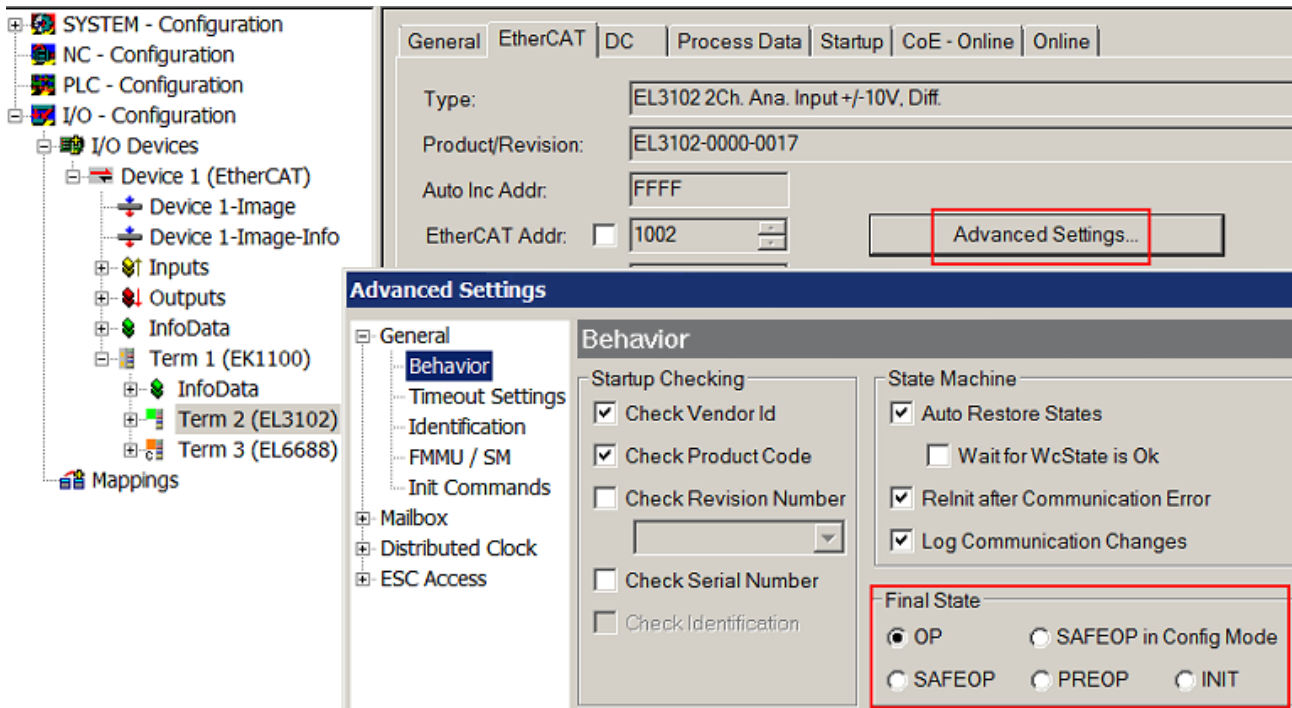

Fig. 126: Default target state in the Slave

Manual Control

There are particular reasons why it may be appropriate to control the states from the application/task/PLC. For instance:

- for diagnostic reasons
- to induce a controlled restart of axes
- because a change in the times involved in starting is desirable

In that case it is appropriate in the PLC application to use the PLC function blocks from the *TcEtherCAT.lib*, which is available as standard, and to work through the states in a controlled manner using, for instance, *FB_EcSetMasterState*.

It is then useful to put the settings in the EtherCAT Master to INIT for master and slave.

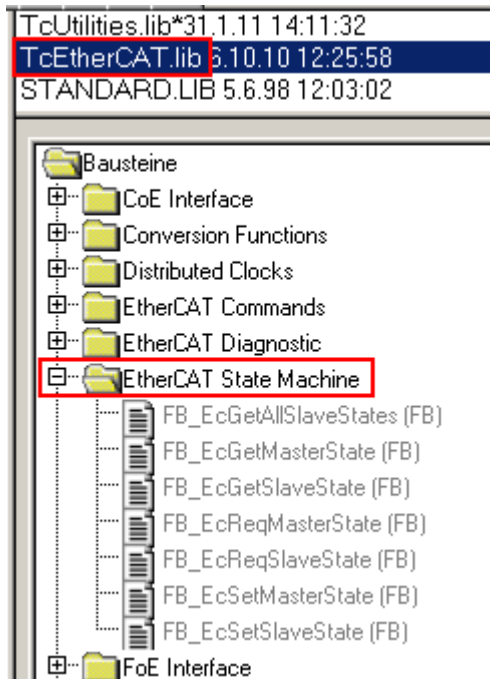

Fig. 127: PLC function blocks

Note regarding E-Bus current

EL/ES terminals are placed on the DIN rail at a coupler on the terminal strand. A Bus Coupler can supply the EL terminals added to it with the E-bus system voltage of 5 V; a coupler is thereby loadable up to 2 A as a rule. Information on how much current each EL terminal requires from the E-bus supply is available online and in the catalogue. If the added terminals require more current than the coupler can supply, then power feed terminals (e.g. EL9410) must be inserted at appropriate places in the terminal strand.

The pre-calculated theoretical maximum E-Bus current is displayed in the TwinCAT System Manager as a column value. A shortfall is marked by a negative total amount and an exclamation mark; a power feed terminal is to be placed before such a position.

General Adapter EtherCAT Online CoE - Online						
NetId:		10.43.2.149.2.1		Advanced Settings...		
Number	Box Name	Address	Type	In Size	Out S...	E-Bus (..
1	Term 1 (EK1100)	1001	EK1100			
2	Term 2 (EL3102)	1002	EL3102	8.0		1830
3	Term 4 (EL2004)	1003	EL2004		0.4	1730
4	Term 5 (EL2004)	1004	EL2004		0.4	1630
5	Term 6 (EL7031)	1005	EL7031	8.0	8.0	1510
6	Term 7 (EL2808)	1006	EL2808		1.0	1400
7	Term 8 (EL3602)	1007	EL3602	12.0		1210
8	Term 9 (EL3602)	1008	EL3602	12.0		1020
9	Term 10 (EL3602)	1009	EL3602	12.0		830
10	Term 11 (EL3602)	1010	EL3602	12.0		640
11	Term 12 (EL3602)	1011	EL3602	12.0		450
12	Term 13 (EL3602)	1012	EL3602	12.0		260
13	Term 14 (EL3602)	1013	EL3602	12.0		70
14	Term 3 (EL6688)	1014	EL6688	22.0		-240 !

Fig. 128: Illegally exceeding the E-Bus current

From TwinCAT 2.11 and above, a warning message "E-Bus Power of Terminal..." is output in the logger window when such a configuration is activated:

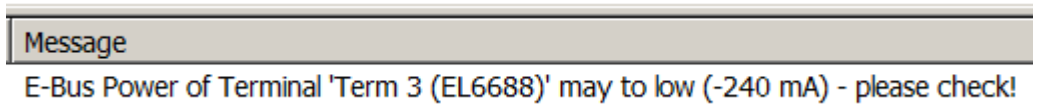

Fig. 129: Warning message for exceeding E-Bus current

NOTE

Caution! Malfunction possible!

The same ground potential must be used for the E-Bus supply of all EtherCAT terminals in a terminal block!

6.4 Configuration

BACnet MS/TP is supported in the following versions of TwinCAT:

- TwinCAT2, Build 2259
- TwinCAT3, Build 4022 (BETA)

BACnet MS/TP is supported in the following controllers:

- Min. CX9020 or higher

BACnet MS/TP device

BACnet MS/TP may be configured in the TwinCAT System Manager in the device category „BACnet“. A MS/TP connection may be added to the system configuration by selecting "I/O Devices". The MS/TP device connects a terminal EL6861 to the TwinCAT system.

It is recommended to scan the terminals before adding a MS/TP device. The terminal / IO-device connection may be specified in a single step.

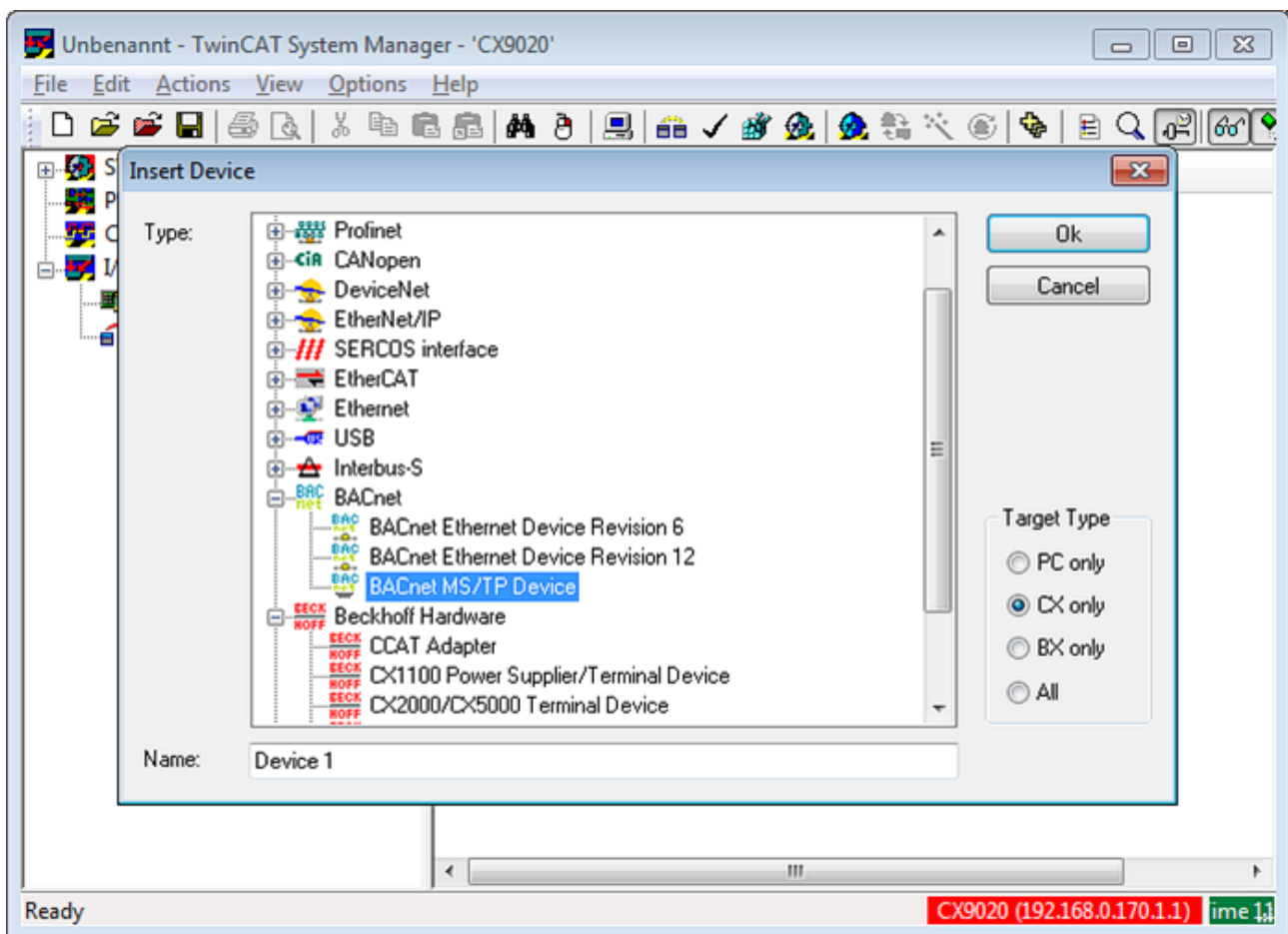

Fig. 130: Inserting BACnet MS/TP Device in TwinCAT

In the following dialog all EL6861 terminals available in the system configuration are shown in a list. Multiple MS/TP channels may be connected to a single controller. Each of the terminals may be operated as a single sub-bus-system or optionally be included into a routing to other MS/TP channels or BACnet/IP.

Select the terminal you want to connect to the MS/TP IO device.

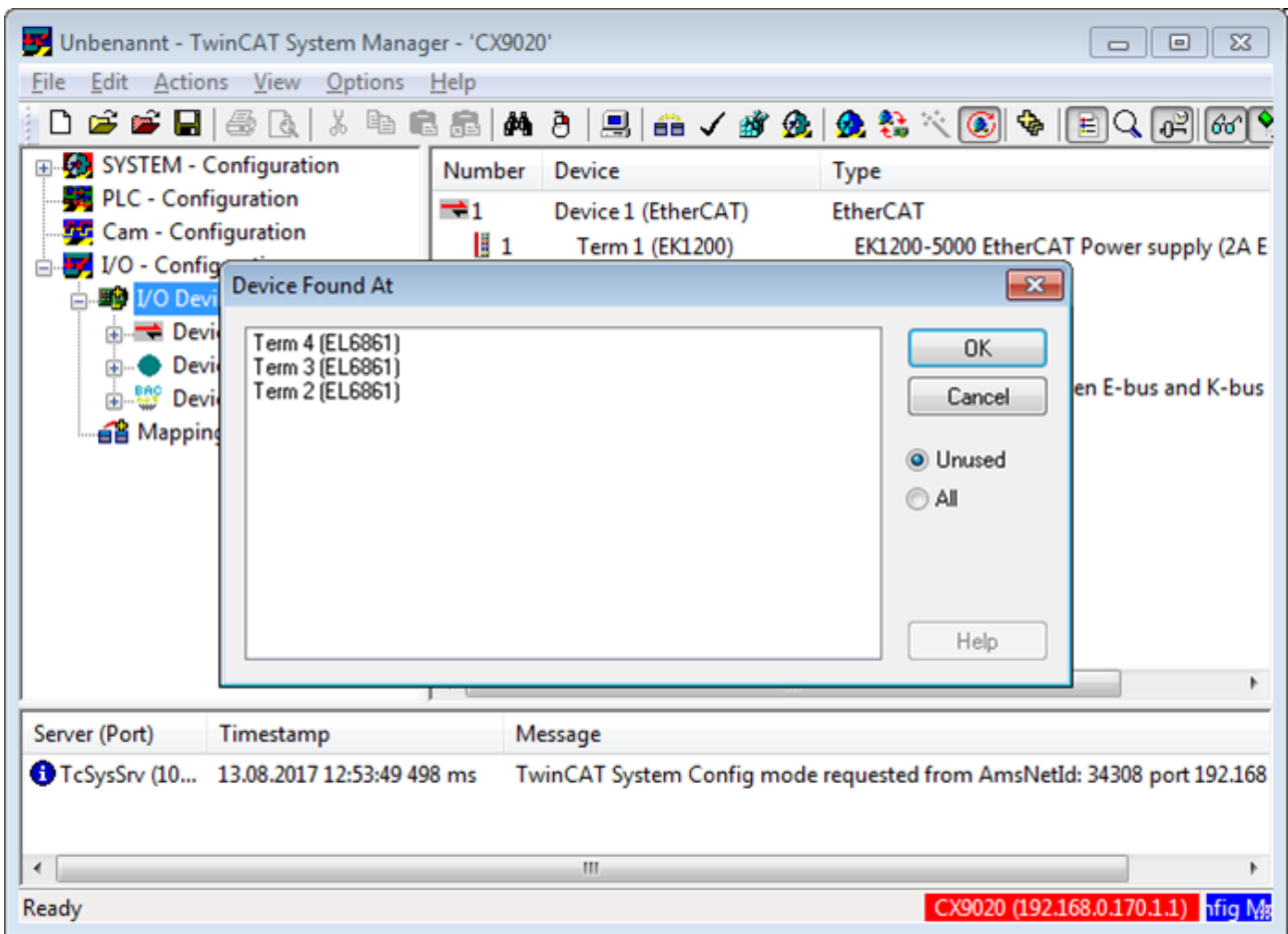

Fig. 131: Selection of the desired terminal

EIA-485 Adapter

Specify the settings for the MS/TP interface in the following dialog box:.

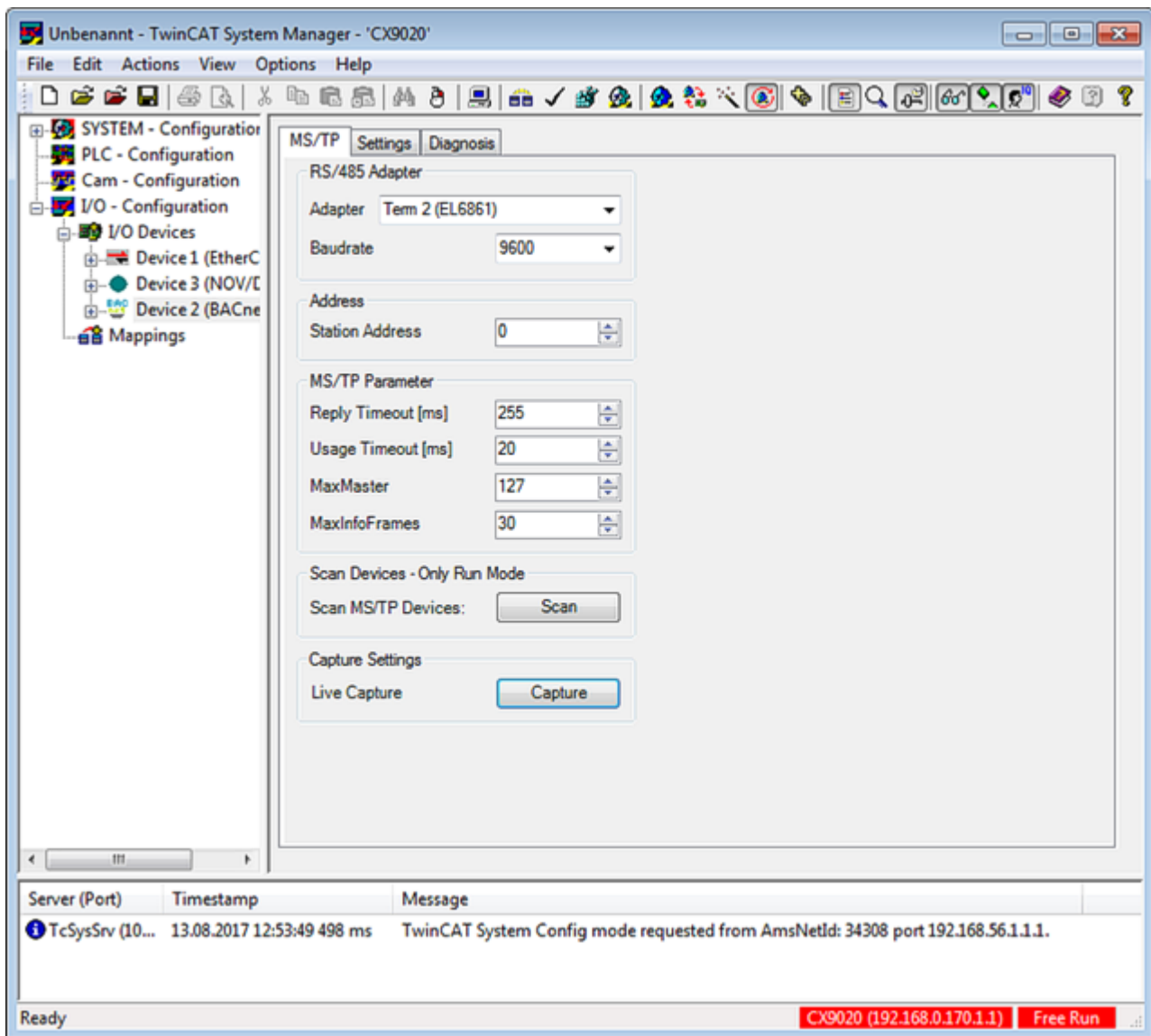

Fig. 132: Setting of the MS/TP interface

Adapter

Select the EL6861 terminal to connect to the BACnet MS/TP IO device.

Baudrate

Select the baud-rate of the MS/TP network. All devices within the same network shall be configured to the same baud-rate.

Station Address

Setup the station address of the MS/TP IO device. Each MAC-address within one MS/TP network shall be unique. The BACnet MS/TP IO device only supports the MS/TP master mode. Possible values of the station address range from 0-127.

Reply Timeout

Specifies the timeout value how long the IO devices waits for a response „DataAvailable“ or „ReceiveError“. The default value equals 255ms and may be adjusted up to 300ms if necessary.

Usage Timeout

Specifies the minimum time without receipt of a „DataAvailable“ or „ReceiveError“ telegram the node has to wait before using the token or responding to a PollForMaster telegram. The default value equals 20ms and may be adjusted up to 100ms if necessary.

Max Master

Specifies the highest station address used in the network. If the highest address is not known, the default value of 127 shall be used.

Max Info Frames

Specifies the number of telegrams the device may send before it has to pass the token to the successor device. The standard value equals 30.

Scan Devices – Only Run Mode

Scan MS/TP Devices: This option allows to determine MS/TP devices connected to the terminal using the BACnet-services „Who-Is“ and „I-Am“. Slave-devices do not support this functionality and must be configured manually. This function is only available in Run-mode. The PLC project has to be activated and the PLC needs to be in Run-mode. After this Dynamic Device Binding feature may be used to determine other MS/TP masters on the network. If MS/TP devices were found and transferred to the System Manager configuration, this configuration needs to be activated again.

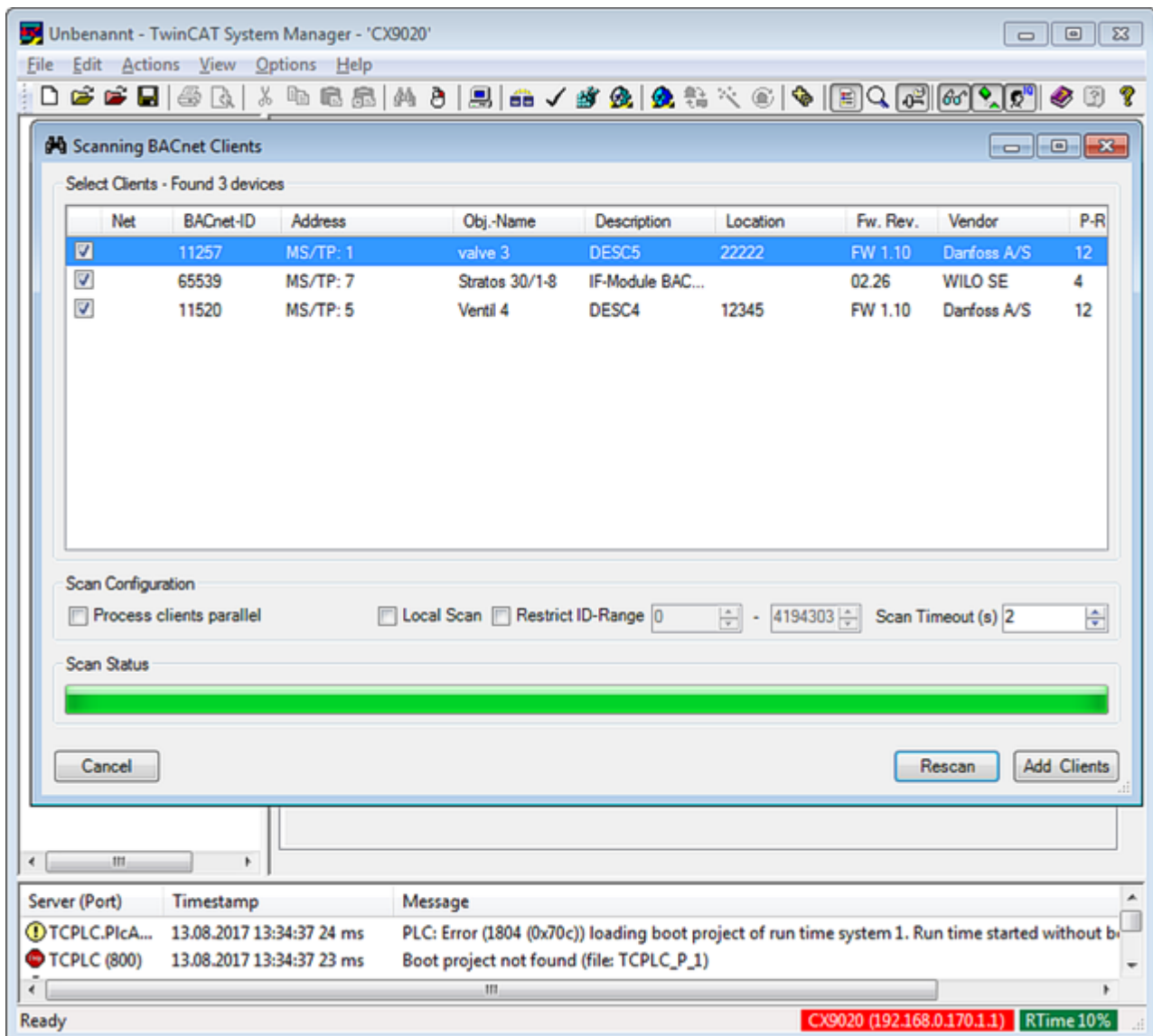

Fig. 133: Dialog „Scanning BACnet Devices“

Capture Settings

Live Capture: This option captures the communication within the MS/TP network. The capture files may be used for analysis using network tools like Wireshark. This option is only available in TwinCAT3.

The capture file will be stored on a local storage medium. Depending upon the operating system the names may vary. In the example below the filename “capture” and a USB memory stick („Hard Disk2“) connected to the PLC was used.

The button „Start“ starts the capture process, the number of telegrams captured is displayed in the right column of the dialog window. The button „Stop“ terminates the capture process. After this the storage media may be disconnected from the PLC.

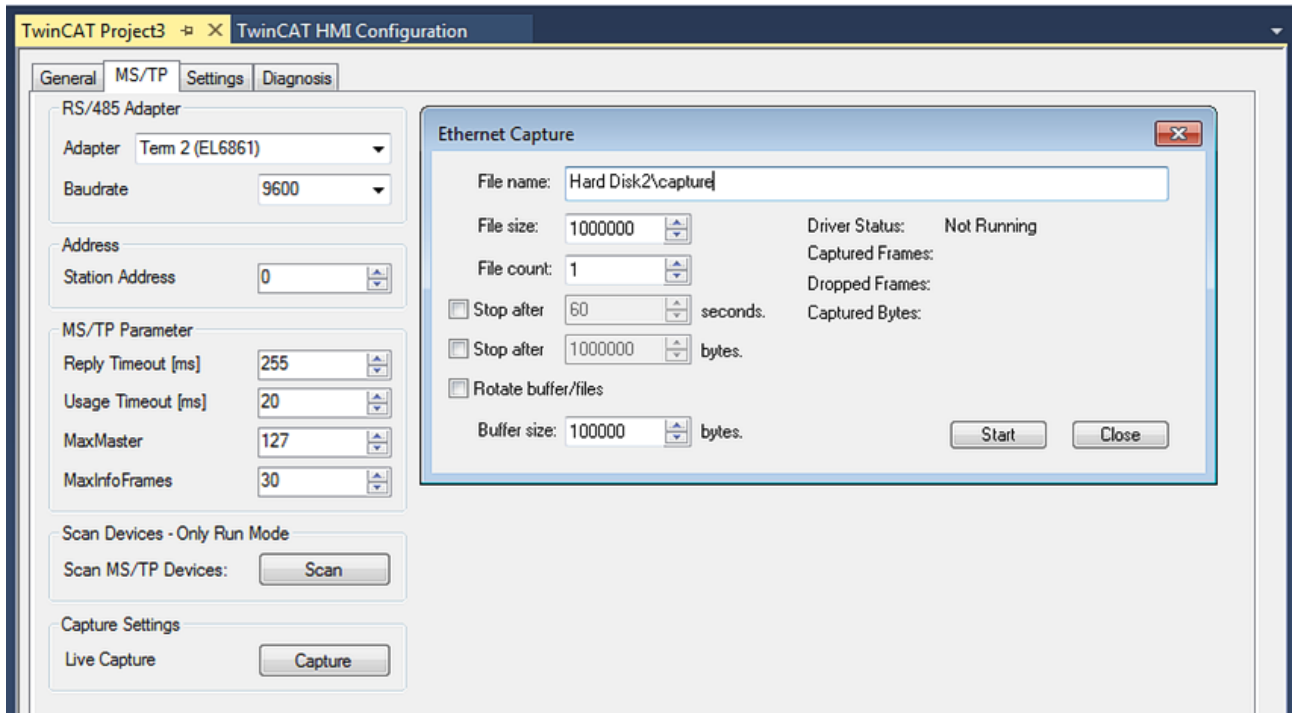

Fig. 134: TwinCAT3: Ethernet Capture Start

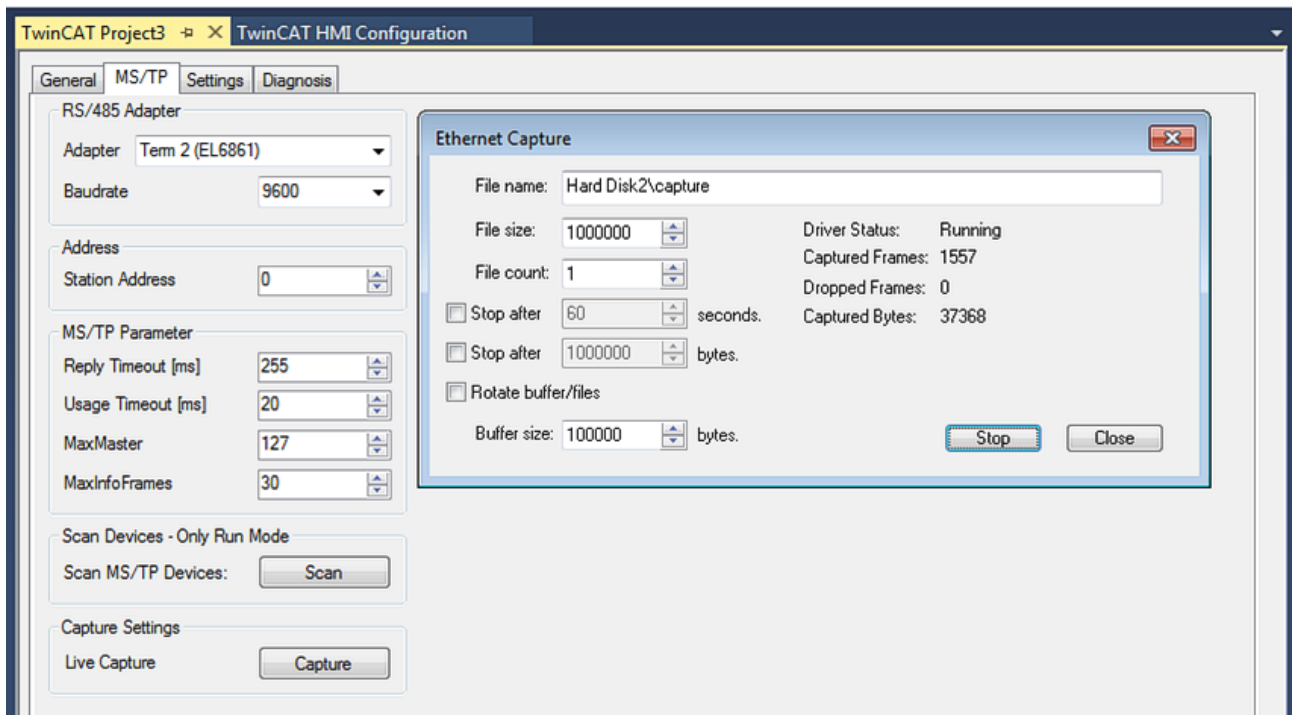

Fig. 135: TwinCAT3: Ethernet Capture Stop

The captured file uses the file extension „.pcap“ and may directly imported into Wireshark or other network analysis tools. In addition the filename contains date and time of the capture.

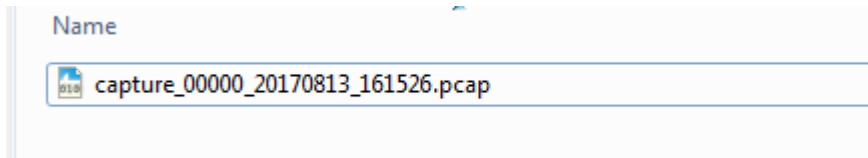

Fig. 136: Recorded file „capture*.pcap“

No.	Time	Time Diff	Source	Destination	Protocol	Length	Info
5321	2017-08-13 18:16:01,143000000	0.006000000	0x01	0x05	BACnet	8	BACnet MS/TP Token
5322	2017-08-13 18:16:01,149000000	0.006000000	0x05	0x07	BACnet	8	BACnet MS/TP Token
5323	2017-08-13 18:16:01,155000000	0.006000000	0x07	0x53	BACnet	8	BACnet MS/TP Poll For Master
5324	2017-08-13 18:16:01,171000000	0.016000000	0x07	0x00	BACnet	8	BACnet MS/TP Token
5325	2017-08-13 18:16:01,171000000	0.000000000	0x00	0x01	BACnet	8	BACnet MS/TP Token
5326	2017-08-13 18:16:01,177000000	0.006000000	0x01	0x05	BACnet	8	BACnet MS/TP Token
5327	2017-08-13 18:16:01,183000000	0.006000000	0x05	0x07	BACnet	8	BACnet MS/TP Token
5328	2017-08-13 18:16:01,189000000	0.006000000	0x07	0x54	BACnet	8	BACnet MS/TP Poll For Master
5329	2017-08-13 18:16:01,205000000	0.016000000	0x07	0x00	BACnet	8	BACnet MS/TP Token
5330	2017-08-13 18:16:01.205000000	0.000000000	0x00	0x01	BACnet	8	BACnet MS/TP Token

Fig. 137: Display in Wireshark

Rules for unique addressing in a BACnet Internetwork

A BACnet Internetwork describes two or more networks connected by BACnet-router devices (most likely supporting different data-link-layer, e.g. BACnet/IP and MS/TP).

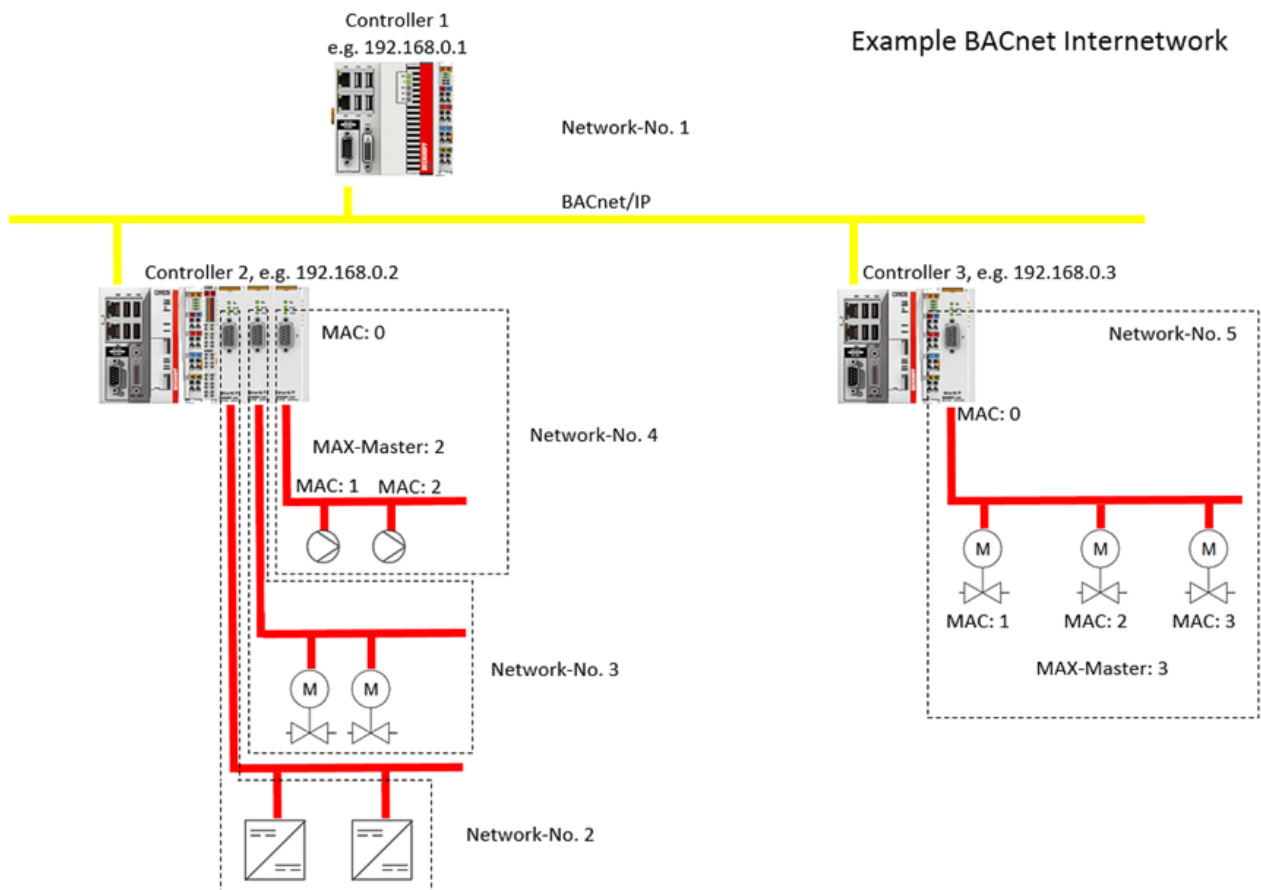

Fig. 138: Scheme of BACnet Internetwork

- The Device-instance-number and the Device-object-name shall be unique for all BACnet devices within the entire BACnet-Internetwork.

- Within each single BACnet-network the MAC address of each device shall be unique. Depending on the data-link-layer the length of the MAC address may be different (BACnet/IP: 6 Byte = 4 Byte IP address+2 Byte UDP-Port, MS/TP: 1 Byte 0-127 for MS/TP master).
- BACnet-Router, which connect BACnet networks are configured knowing their individual BACnet network number. The BACnet network number of each single BACnet network shall be unique within the entire BACnet internetwork as well.
- Devices w/o routing capabilities may be configured for BACnet network no. 0, which means they reside within the "local network".

BACnet-Routing (currently only available in beta state)

BACnet devices using different network media (data-link-layer) may be connected through BACnet router devices. Those devices provide a logical connection on network layer-3. Due to the routing provided the BACnet application layer 7 (reading or writing values, sending alarms, Dynamic Device Binding, etc.) is transparent to all BACnet devices. There is no need to translate the data compared to gateway applications.

BACnet-Network numbers

Every network connected to a BACnet router and so linked to other BACnet networks requires a unique network number in the range from 1-65534. The network number is assigned in the router. The BACnet network number is required to be unique with the entire BACnet inter-network (across all connected media and sub-networks). Using the terminal EL6861 it is up to the configuration whether to use the terminal as a single sub-network w/o routing to other networks or connecting to other BACnet networks through the supported routing functionality.

Setting up routing information

The router settings are provided in the dialog „Settings“ / „System Manager Settings“.

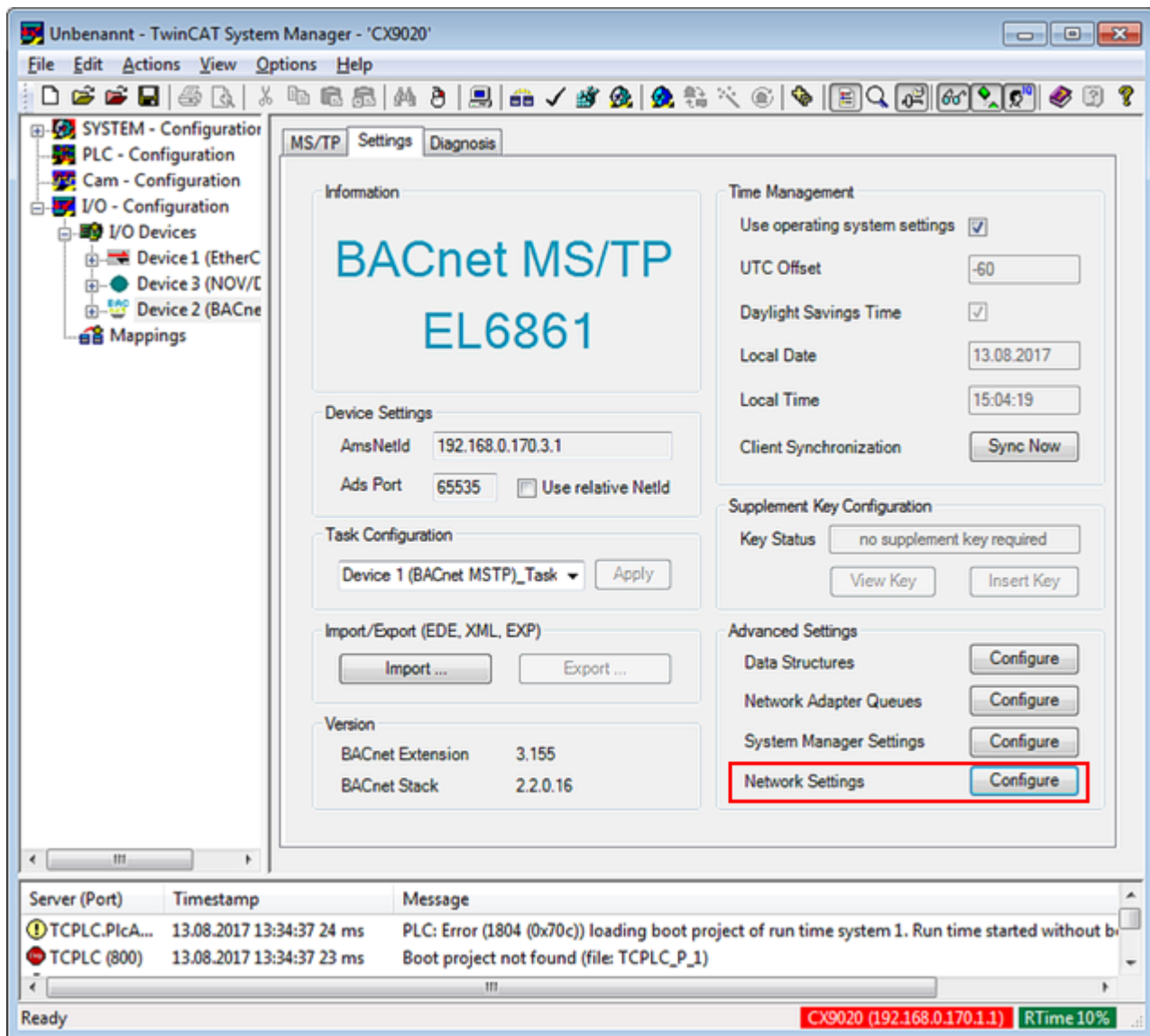

Fig. 139: Setting of the routing information

In the following dialog specify the network number and activate the Checkbox „Enable Routing (beta)“. Confirm these settings by choosing „Save“.

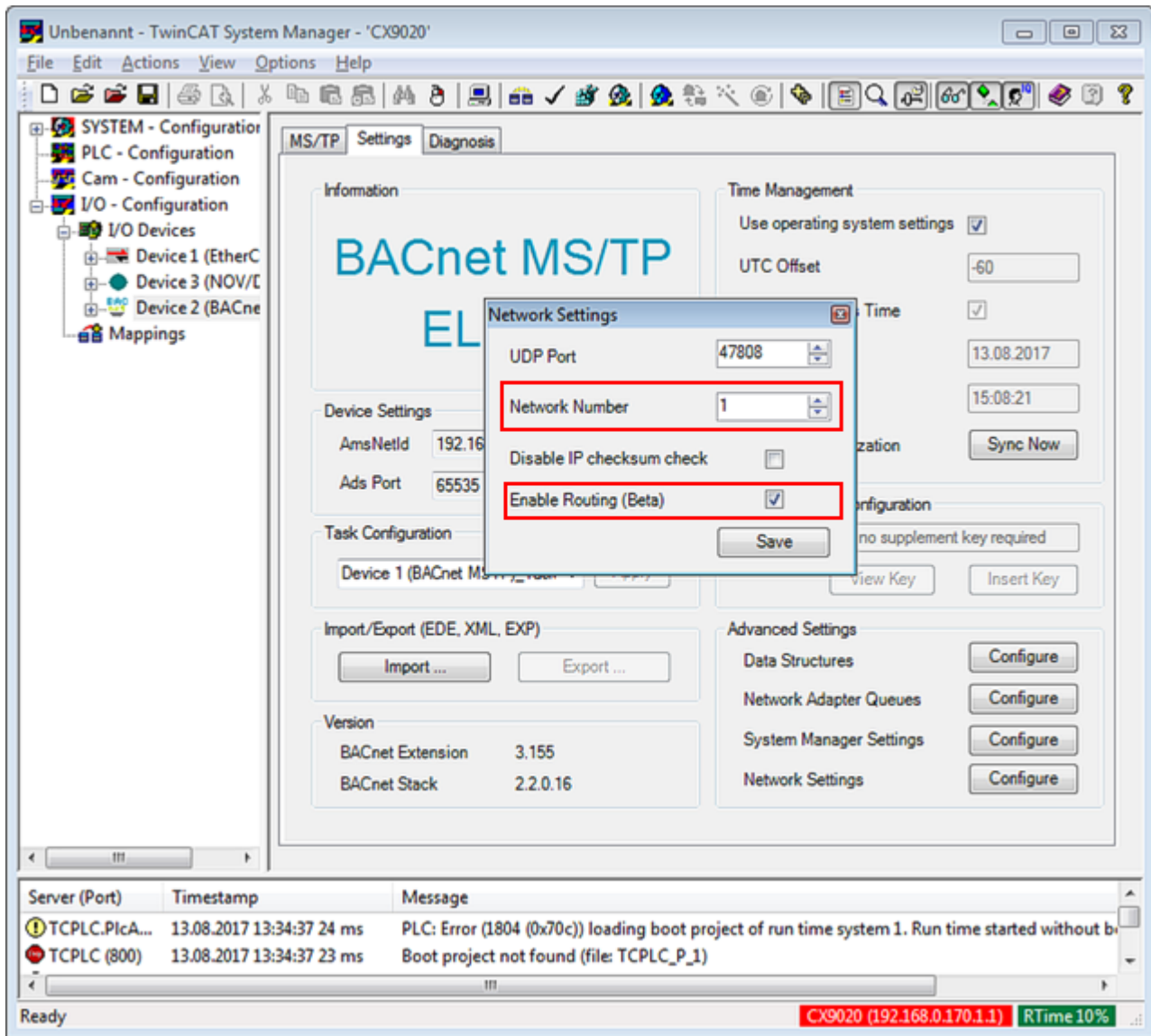

Fig. 140: Setting off he network number

Repeat these settings for all BACnet networks which take part in the BACnet routing. (the following example shows the BACnet/IP supplement configured as router).

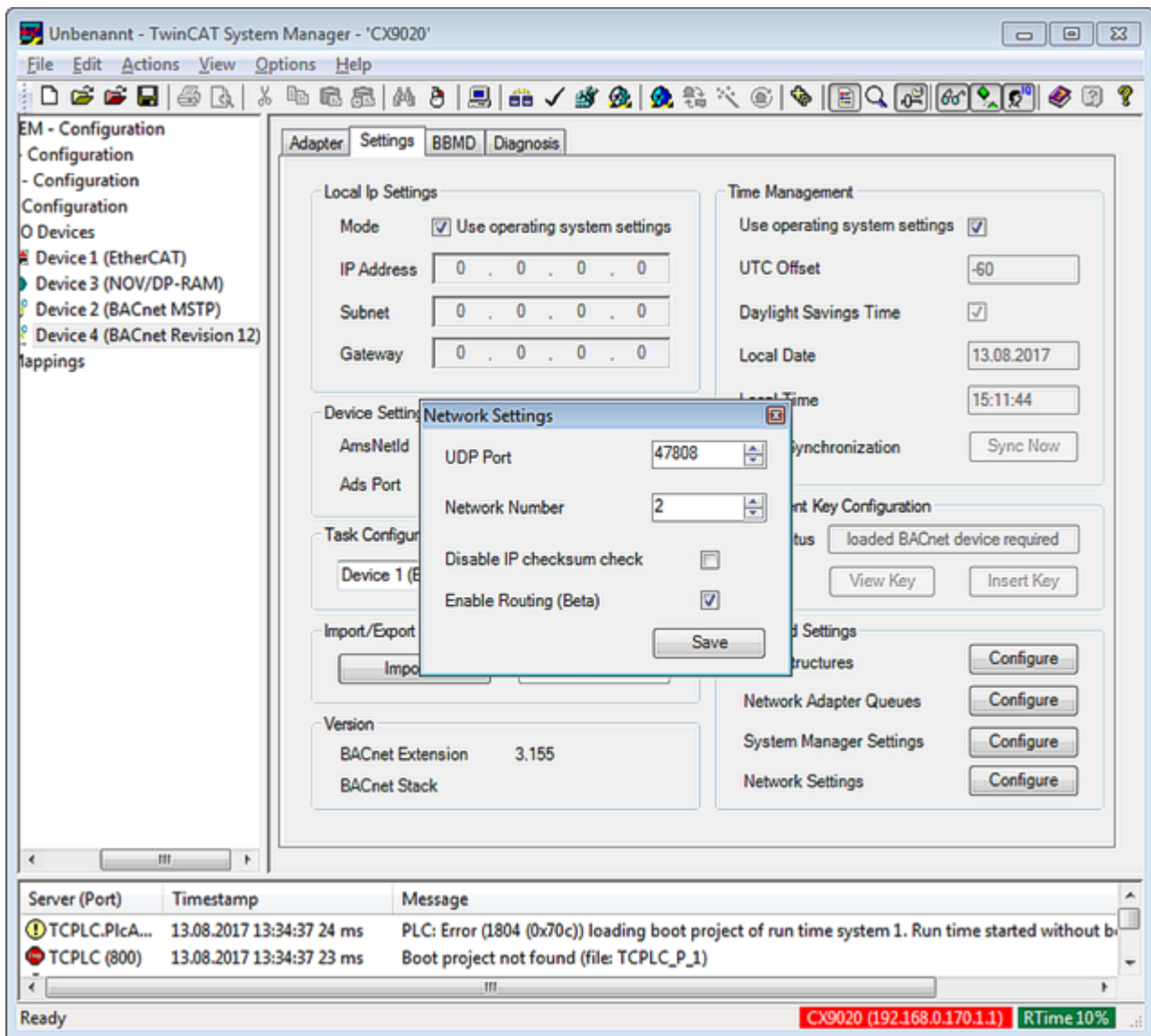

Fig. 141: Make settings for all networks

After activating this example configuration a routing between network 1 (MS/TP) and network 2 (BACnet/IP) will be established. Other devices on the network, e.g. a BACnet/IP management station may request data from devices connected to MS/TP.

6.5 Object description and parameterization

● EtherCAT XML Device Description

i The display matches that of the CoE objects from the EtherCAT XML Device Description. We recommend downloading the latest XML file from the download area of the Beckhoff website and installing it according to installation instructions.

● Parameterization via the CoE list (CAN over EtherCAT)

i The EtherCAT device is parameterized via the CoE - Online tab [► 87] (double-click on the respective object) or via the Process Data tab [► 84] (allocation of PDOs). Please note the following general CoE notes [► 18] when using/manipulating the CoE parameters:

- Keep a startup list if components have to be replaced
- Differentiation between online/offline dictionary, existence of current XML description
- use "CoE reload" for resetting changes

6.5.1 Restore object

Index 1011 Restore default parameters

Index (hex)	Name	Meaning	Data type	Flags	Default
1011:0	Restore default parameters	Restore default settings	UINT8	RO	0x01 (1 _{dec})
1011:01	SubIndex 001	If this object is set to "0x64616F6C" in the set value dialog, all backup objects are reset to their delivery state.	UINT32	RW	0x00000000 (0 _{dec})

6.5.2 Configuration data

Index 8000 COM Settings

Index (hex)	Name	Meaning	Data type	Flags	Default
8000:0	COM Settings	Maximum subindex	UINT8	RO	>27<
8000:11	Baud rate	Baud rate 1: 300 Baud 2: 600 Baud 3:1200 Baud 4: 2400 Baud 5: 4800 Baud 6: 9600 Baud 7: 19.2 kbaud 8: 38.4 kbaud 9: 57.6 kbaud 10: 115.2 kbaud 11: Use explicit baudrate (subindex 0x1B) 12: 76.8 kbaud	BIT4	RW	9600 Baud (6)
8000:1A	Rx buffer full notification	The value specifies the number of data in the receive FIFO, from which the bit "buffer full" is set.	UINT16	RW	0x0360 (864 _{dec})
8000:1B	Explicit baudrate	In this object the desired baud rate can be entered directly as a number. (can be activated in object 8000:11)	UINT32	RW	0x00002580 (9600 _{dec})

Index 800F COM Ext Settings

Index (hex)	Name	Meaning	Data type	Flags	Default	
800F:0	COM Ext Settings	Maximum subindex	UINT8	RO	>1<	
800F:01	Tx buffer Low Water	([800F:01] & 0x0FFF)	UINT16	RW	0x0000 (0 _{dec})	
		Bit 12				1: The explicitly set baud rate is not checked for min (300) and max (256,000)
		Bit 13				1: Invalid input data is zeroed
		Bit 14				res.
		Bit 15				0: 8 byte blocks are copied into each process data input 1: 128 byte blocks are copied into each process data input

6.5.3 Input data

Index 6000 COM Inputs

Index (hex)	Name	Meaning	Data type	Flags	Default	
6000:0	Com Inputs	Maximum subindex	UINT8	RO	>137<	
6000:01	Transmit accepted	The terminal acknowledges receipt of data by changing the state of this bit. Only now new data can be transferred from the controller to the terminal.	BOOLEAN	RO	FALSE	
6000:02	Receive request	By changing the state of this bit, the terminal informs the controller that the DataIn bytes contain the number of bytes displayed in "Input length". The controller must acknowledge receipt of the data by changing the state of the ReceiveAccepted bit. Only then new data can be transferred from the terminal to the controller.	BOOLEAN	RO	FALSE	
6000:03	Init accepted	0	The terminal is ready again for serial data exchange.	BOOLEAN	RO	FALSE
		1				
6000:04	Buffer full	The reception FIFO is full. All incoming data will be lost from this point on!	BOOLEAN	RO	FALSE	
6000:05	Parity error	A parity error has occurred.	BOOLEAN	RO	FALSE	
6000:06	Framing error	A framing error has occurred.	BOOLEAN	RO	FALSE	
6000:07	Overrun error	An overrun error has occurred.	BOOLEAN	RO	FALSE	
6000:08	Tx buffer empty	No data in Tx buffer	BOOLEAN	RO	FALSE	
6000:09	Input length	Number of input bytes available for transfer from the terminal to the controller.	UINT8	RO	0x00 (0 _{dec})	
6000:0A	Data In 0	Input byte 0	UINT8	RO	0x00 (0 _{dec})	
...	
6000:89	Data In 127	Input byte 127	UINT8	RO	0x00 (0 _{dec})	

6.5.4 Output data

Index 7000 COM Outputs

Index (hex)	Name	Meaning	Data type	Flags	Default	
7000:0	Com Outputs	Maximum subindex	UINT8	RO	>137<	
7000:01	Transmit request	By changing the state of this bit, the controller informs the terminal that the DataOut bytes contain the number of bytes displayed in "Output length". The terminal acknowledges receipt of the data by changing the state of the "TransmitAccepted" bit. Only now new data can be transferred from the controller to the terminal.	BOOLEAN	RO	FALSE	
7000:02	Receive accepted	The controller acknowledges receipt of data by changing the state of this bit. Only then new data can be transferred from the terminal to the controller.	BOOLEAN	RO	FALSE	
7000:03	Init request	0	The controller once again requests the terminal to prepare for serial data exchange.	BOOLEAN	RO	FALSE
		1				
7000:04	Send continuous	Continuous sending of data from the FIFO. The send buffer is filled (up to 128 bytes) by the controller. The filled buffer contents will be sent on the rising edge of the bit. If the data has been transferred, the terminal informs the controller by setting the "Init accepted" bit. "Init accepted" is cleared with "SendContinuous".	BOOLEAN	RO	FALSE	
7000:09	Output len	Number of output bytes available for transfer from the controller to the terminal.	UINT8	RO	0x00 (0 _{dec})	
7000:0A	Data Out 0	Output byte 0	UINT8	RO	0x00 (0 _{dec})	
...	
7000:89	Data Out 127	Output byte 127	UINT8	RO	0x00 (0 _{dec})	

6.5.5 Information data

Index 9000 COM Info

Index (hex)	Name	Meaning	Data type	Flags	Default
9000:0	COM Info	Maximum subindex	UINT8	RO	>11<
9000:01	Rxd Bytes	Number of bytes received	UINT16	RO	0x0000 (0 _{dec})
9000:02	Txd Bytes	Number of bytes sent	UINT16	RO	0x0000 (0 _{dec})
9000:03	Buffer overflow	Number of buffer overflow errors	UINT16	RO	0x0000 (0 _{dec})
9000:04	Parity error	Number of parity errors	UINT16	RO	0x0000 (0 _{dec})
9000:05	Framing error	Number of framing errors	UINT16	RO	0x0000 (0 _{dec})
9000:06	Overrun error	Number of overrun errors	UINT16	RO	0x0000 (0 _{dec})
9000:07	Buffer full	Number of "Buffer full" events	UINT16	RO	0x0000 (0 _{dec})
9000:08	Res 0		UINT16	RO	0x0000 (0 _{dec})
9000:09	Res 1		UINT16	RO	0x0000 (0 _{dec})
9000:0A	Res 2		UINT16	RO	0x0000 (0 _{dec})
9000:0B	Res 3		UINT16	RO	0x0000 (0 _{dec})

6.5.6 Diagnostic data

Index A000 COM Diag data

Index (hex)	Name	Meaning	Data type	Flags	Default
A000:0	STM Diag data Ch.1	Maximum subindex	UINT8	RO	>18<
A000:01	Buffer overflow	A buffer overflow has occurred.	BOOLEAN	RO	FALSE
A000:02	Parity error	A parity error has occurred.	BOOLEAN	RO	FALSE
A000:03	Framing error	A framing error has occurred	BOOLEAN	RO	FALSE
A000:04	Overrun error	An overrun error has occurred.	BOOLEAN	RO	FALSE
A000:05	Buffer full	The reception FIFO is full. All incoming data will be lost from this point on!	BOOLEAN	RO	FALSE
A000:11	Data bytes in send buffer	Number of data bytes in the send FIFO	UINT16	RO	0x0000 (0 _{dec})
A000:12	Data bytes in receive buffer	Number of data bytes in the receive FIFO	UINT16	RO	0x0000 (0 _{dec})

6.6 Object description - standard objects

Index 1000 Device type

Index (hex)	Name	Meaning	Data type	Flags	Default
1000:0	Device type	Device type of the EtherCAT slave: The Lo-Word contains the CoE profile used (5001). The Hi-Word contains the module profile according to the modular device profile.	UINT32	RO	0x02581389 (39326601 _{dec})

Index 1008 Device name

Index (hex)	Name	Meaning	Data type	Flags	Default
1008:0	Device name	Device name of the EtherCAT slave	STRING	RO	EL6861

Index 1009 Hardware version

Index (hex)	Name	Meaning	Data type	Flags	Default
1009:0	Hardware version	Hardware version of the EtherCAT slave	STRING	RO	-

Index 100A Software version

Index (hex)	Name	Meaning	Data type	Flags	Default
100A:0	Software version	Firmware version of the EtherCAT slave	STRING	RO	-

Index 1011 Restore default parameters

Index (hex)	Name	Meaning	Data type	Flags	Default
1011:0	Restore default parameters	Restore default settings	UINT8	RO	0x01 (1 _{dec})
1011:01	SubIndex 001	If this object is set to " 0x64616F6C " in the set value dialog, all backup objects are reset to their delivery state.	UINT32	RW	0x00000000 (0 _{dec})

Index 1018 Identity

Index (hex)	Name	Meaning	Data type	Flags	Default
1018:0	Identity	Information for identifying the slave	UINT8	RO	0x04 (4 _{dec})
1018:01	Vendor ID	Vendor ID of the EtherCAT slave	UINT32	RO	0x00000002 (2 _{dec})
1018:02	Product code	Product code of the EtherCAT slave	UINT32	RO	0x1ACD3052 (449654866 _{dec})
1018:03	Revision	Revision number of the EtherCAT slave; the Low Word (bit 0-15) indicates the special terminal number, the High Word (bit 16-31) refers to the device description	UINT32	RO	-
1018:04	Serial number	Serial number of the EtherCAT slave; the Low Byte (bit 0-7) of the Low Word contains the year of production, the High Byte (bit 8-15) of the Low Word contains the week of production, the High Word (bit 16-31) is 0	UINT32	RO	-

Index 10F0 Backup parameter handling

Index (hex)	Name	Meaning	Data type	Flags	Default
10F0:0	Backup parameter handling	Information for standardized loading and saving of backup entries	UINT8	RO	0x01 (1 _{dec})
10F0:01	Checksum	Checksum across all backup entries of the EtherCAT slave	UINT32	RO	-

Index 1600 COM RxPDO-Map

Index (hex)	Name	Meaning	Data type	Flags	Default
1600:0	COM RxPDO-Map	PDO Mapping COM Outputs	UINT8	RO	>134<
1600:01	SubIndex 001	1. PDO Mapping entry (object 0x7000 (COM Outputs), entry 0x01 (Transmit request))	UINT32	RO	0x7000:01, 1
1600:02	SubIndex 002	2. PDO Mapping entry (object 0x7000 (COM Outputs), entry 0x02 (Receive accepted))	UINT32	RO	0x7000:02, 1
1600:03	SubIndex 003	3. PDO Mapping entry (object 0x7000 (COM Outputs), entry 0x03 (Init request))	UINT32	RO	0x7000:03 1
1600:04	SubIndex 004	4. PDO Mapping entry (object 0x7000 (COM Outputs), entry 0x04 (Send continuous))	UINT32	RO	0x7000:04, 1
1600:05	SubIndex 005	5. PDO Mapping entry (4 bits align)	UINT32	RO	0x0000:00, 4
1600:06	SubIndex 006	6. PDO Mapping entry (object 0x7000 (COM Outputs), entry 0x09 (Output len))	UINT32	RO	0x7000:09, 8
1600:07	SubIndex 007	7. PDO Mapping entry (object 0x7000 (COM Outputs), entry 0x09 (Data Out 0))	UINT32	RO	0x7000:0A, 8
...
1600:86	SubIndex 008	134. PDO Mapping entry (object 0x7000 (COM Outputs), entry 0x89 (Data Out 127))	UINT32	RO	0x7000:89, 8

Index 1A00 COM TxPDO-Map Inputs

Index (hex)	Name	Meaning	Data type	Flags	Default
1A00:0	COM RxPDO-Map	PDO Mapping DMX Status	UINT8	RW	>137<
1A00:01	SubIndex 001	1. PDO Mapping entry (object 0x6000 (COM Inputs), entry 0x01 (Transmit accepted))	UINT32	RW	0x6000:01, 1
1A00:02	SubIndex 002	2. PDO Mapping entry (object 0x6000 (COM Inputs), entry 0x02 (Receive request))	UINT32	RW	0x6000:02, 1
1A00:03	SubIndex 003	3. PDO Mapping entry (object 0x6000 (COM Inputs), entry 0x03 (Init accepted))	UINT32	RW	0x6000:03, 1
1A00:04	SubIndex 004	4. PDO Mapping entry (object 0x6000 (COM Inputs), entry 0x04 (Buffer full))	UINT32	RW	0x6000:04, 1
1A00:05	SubIndex 005	5. PDO Mapping entry (object 0x6000 (COM Inputs), entry 0x05 (Parity error))	UINT32	RW	0x6000:05, 1
1A00:06	SubIndex 006	6. PDO Mapping entry (object 0x6000 (COM Inputs), entry 0x06 (Framing error))	UINT32	RW	0x6000:06, 1
1A00:07	SubIndex 007	7. PDO Mapping entry (object 0x6000 (COM Inputs), entry 0x07 (Overrun error))	UINT32	RW	0x6000:07, 1
1A00:08	SubIndex 008	8. PDO Mapping entry (object 0x6000 (COM Inputs), entry 0x08 (Tx buffer empty))	UINT32	RW	0x6000:08, 1
1A00:09	SubIndex 009	9. PDO Mapping entry (object 0x6000 (COM Inputs), entry 0x09 (Input length))	UINT32	RW	0x6000:09, 8
1A00:0A	SubIndex 010	10. PDO Mapping entry (object 0x6000 (COM Inputs), entry 0x0A (Data In 0))	UINT32	RW	0x6000:0A, 8
...
1A00:0B	SubIndex 137	11. PDO Mapping entry (object 0x6000 (COM Inputs), entry 0x89 (Data In 127))	UINT32	RW	0x6000:89, 8

Index 1C00 Sync manager type

Index (hex)	Name	Meaning	Data type	Flags	Default
1C00:0	Sync manager type	Using the sync managers	UINT8	RO	0x04 (4 _{dec})
1C00:01	SubIndex 001	Sync-Manager Type Channel 1: Mailbox Write	UINT8	RO	0x01 (1 _{dec})
1C00:02	SubIndex 002	Sync-Manager Type Channel 2: Mailbox Read	UINT8	RO	0x02 (2 _{dec})
1C00:03	SubIndex 003	Sync-Manager Type Channel 3: Process Data Write (Outputs)	UINT8	RO	0x03 (3 _{dec})
1C00:04	SubIndex 004	Sync-Manager Type Channel 4: Process Data Read (Inputs)	UINT8	RO	0x04 (4 _{dec})

Index 1C12 RxPDO assign

Index (hex)	Name	Meaning	Data type	Flags	Default
1C12:0	RxPDO assign	PDO Assign Outputs	UINT8	RW	0x09 (9 _{dec})
1C12:01	SubIndex 001	1. allocated RxPDO (contains the index of the associated RxPDO mapping object)	UINT16	RW	0x1600 (5632 _{dec})

Index 1C13 TxPDO assign

Index (hex)	Name	Meaning	Data type	Flags	Default
1C13:0	TxPDO assign	PDO Assign Inputs	UINT8	RW	0x02 (2 _{dec})
1C13:01	Subindex 001	1. allocated TxPDO (contains the index of the associated TxPDO mapping object)	UINT16	RW	0x1A00 (6656 _{dec})

Index F000 Modular device profile

Index (hex)	Name	Meaning	Data type	Flags	Default
F000:0	Modular device profile	General information for the modular device profile	UINT8	RO	0x02 (2 _{dec})
F000:01	Module index distance	Index distance of the objects of the individual channels	UINT16	RO	0x0010 (16 _{dec})
F000:02	Maximum number of modules	Number of channels	UINT16	RO	0x0001 (1 _{dec})

Index F008 Code word

Index (hex)	Name	Meaning	Data type	Flags	Default
F008:0	Code word	currently reserved	UINT32	RW	0x00000000 (0 _{dec})

Index F010 Module list

Index (hex)	Name	Meaning	Data type	Flags	Default
F010:0	Module list	Maximum subindex	UINT8	RW	0x01 (1 _{dec})
F010:01	SubIndex 001	reserved	UINT32	RW	0x00000258 (600 _{dec})

Index 1C32 SM output parameter

Index (hex)	Name	Meaning	Data type	Flags	Default
1C32:0	SM output parameter	Synchronization parameters for the outputs	UINT8	RO	0x20 (32 _{dec})
1C32:01	Sync mode	Current synchronization mode: <ul style="list-style-type: none"> 3: DC-Mode - Synchron with SYNC1 Event 	UINT16	RW	0x0001 (1 _{dec})
1C32:02	Cycle time	Cycle time (in ns): <ul style="list-style-type: none"> Free Run: Cycle time of the local timer Synchron with SM 2 Event: Master cycle time DC-Mode: SYNC0/SYNC1 Cycle Time 	UINT32	RW	0x000F4240 (1000000 _{dec})
1C32:03	Shift time	Time between SYNC0 event and output of the outputs (in ns, DC mode only)	UINT32	RO	0x00000000 (0 _{dec})
1C32:04	Sync modes supported	Supported synchronization modes: <ul style="list-style-type: none"> Bit 0 = 1: free run is supported Bit 1 = 1: Synchron with SM 2 Event is supported Bit 2-3 = 01: DC mode is supported Bit 4-5 = 10: Output shift with SYNC1 Event (only DC mode) Bit 14 = 1: dynamic times (measurement through writing of Index 1C32 SM output parameter ▶ 116) 	UINT16	RO	0x0003 (3 _{dec})
1C32:05	Minimum cycle time	Minimum cycle time (in ns)	UINT32	RO	0x00002710 (10000 _{dec})
1C32:06	Calc and copy time	Minimum time between SYNC0 and SYNC1 event (in ns, DC mode only)	UINT32	RO	0x00000000 (0 _{dec})
1C32:07	Minimum delay time		UINT32	RO	0x00000384 (900 _{ez})
1C32:08	Command	<ul style="list-style-type: none"> 0: Measurement of the local cycle time is stopped 1: Measurement of the local cycle time is started <p>The entries Index 1C32 SM output parameter ▶ 116, Index 1C32 SM output parameter ▶ 116, Index 1C32 SM output parameter ▶ 116, Index 1C32 SM output parameter ▶ 116, Index 1C33 SM input parameter ▶ 117, Index 1C32 SM output parameter ▶ 116, Index 1C33 SM input parameter ▶ 117 are updated with the maximum measured values. For a subsequent measurement the measured values are reset</p>	UINT16	RW	0x0000 (0 _{dec})
1C32:09	Maximum Delay time	Time between SYNC1 event and output of the outputs (in ns, DC mode only)	UINT32	RO	0x00000384 (900 _{dec})
1C32:0B	SM event missed counter	Number of missed SM events in OPERATIONAL (DC mode only)	UINT16	RO	0x0000 (0 _{dec})
1C32:0C	Cycle exceeded counter	Number of occasions the cycle time was exceeded in OPERATIONAL (cycle was not completed in time or the next cycle began too early)	UINT16	RO	0x0000 (0 _{dec})
1C32:0D	Shift too short counter	Number of occasions that the interval between SYNC0 and SYNC1 event was too short (DC mode only)	UINT16	RO	0x0000 (0 _{dec})
1C32:20	Sync error	The synchronization was not correct in the last cycle (outputs were output too late; DC mode only)	BOOLEAN	RO	0x00 (0 _{dec})

Index 1C33 SM input parameter

Index (hex)	Name	Meaning	Data type	Flags	Default
1C33:0	SM input parameter	Synchronization parameters for the inputs	UINT8	RO	0x20 (32 _{dec})
1C33:01	Sync mode	<ul style="list-style-type: none"> • 0: Free Run • 1: Synchron with SM 3 Event (no outputs available) • 2: DC - Synchron with SYNC0 Event • 3: DC - Synchron with SYNC1 Event • 34: Synchron with SM 2 event (outputs available) 	UINT16	RW	0x0022 (34 _{dec})
1C33:02	Cycle time	as Index 1C32 SM output parameter [► 116]	UINT32	RW	0x000F4240 (10000 _{dec})
1C33:03	Shift time	Time between SYNC0 event and reading of the inputs (in ns, only DC mode)	UINT32	RO	0x00000384 (900 _{dec})
1C33:04	Sync modes supported	Supported synchronization modes: <ul style="list-style-type: none"> • Bit 0: free run is supported • Bit 1: Synchron with SM 2 Event is supported (outputs available) • Bit 1: Synchron with SM 3 Event is supported (no outputs available) • Bit 2-3 = 01: DC mode is supported • Bit 4-5 = 01: Input shift through local event (outputs available) • Bit 4-5 = 10: Input shift with SYNC1 event (no outputs available) • Bit 14 = 1: dynamic times (measurement through writing of Index 1C32 SM output parameter [► 116] or Index 1C33 SM input parameter [► 117]) 	UINT16	RO	0x0003 (3 _{dec})
1C33:05	Minimum cycle time	as Index 1C32 SM output parameter [► 116]	UINT32	RO	0x000102710 (10000 _{dec})
1C33:06	Calc and copy time	Time between reading of the inputs and availability of the inputs for the master (in ns, only DC mode)	UINT32	RO	0x00000000 (0 _{dec})
1C33:07	Minimum delay time		UINT322	RO	0x00000384 (900 _{dec})
1C33:08	Command	as Index 1C32 SM output parameter [► 116]	UINT16	RW	0x0000 (0 _{dec})
1C33:09	Maximum delay time	Time between SYNC1 event and reading of the inputs (in ns, only DC mode)	UINT32	RO	0x00000384 (900 _{bz})
1C33:0B	SM event missed counter	as Index 1C32 SM output parameter [► 116]	UINT16	RO	0x0000 (0 _{dec})
1C33:0C	Cycle exceeded counter	as Index 1C32 SM output parameter [► 116]	UINT16	RO	0x0000 (0 _{dec})
1C33:0D	Shift too short counter	as Index 1C32 SM output parameter [► 116]	UINT16	RO	0x0000 (0 _{dec})
1C33:20	Sync error	as Index 1C32 SM output parameter [► 116]	BOOLEAN	ROO	0x00 (0 _{dec})

7 Appendix

7.1 EtherCAT AL Status Codes

For detailed information please refer to the [EtherCAT system description](#).

7.2 Firmware compatibility

Beckhoff EtherCAT devices are delivered with the latest available firmware version. Compatibility of firmware and hardware is mandatory; not every combination ensures compatibility. The overview below shows the hardware versions on which a firmware can be operated.

Note

- It is recommended to use the newest possible firmware for the respective hardware.
- Beckhoff is not under any obligation to provide customers with free firmware updates for delivered products.

NOTE

Risk of damage to the device!

Pay attention to the instructions for firmware updates on the [separate page \[► 118\]](#).

If a device is placed in BOOTSTRAP mode for a firmware update, it does not check when downloading whether the new firmware is suitable. This can result in damage to the device! Therefore, always make sure that the firmware is suitable for the hardware version!

EL6861-0000

Hardware (HW)	Firmware (FW)	Revision no.	Release date
00*	04*	EL6861-0000-0017	08/2017

*) This is the current compatible firmware/hardware version at the time of the preparing this documentation. Check on the Beckhoff web page whether more up-to-date [documentation](#) is available.

7.3 Firmware Update EL/ES/EM/EPxxxx

This section describes the device update for Beckhoff EtherCAT slaves from the EL/ES, EM, EK and EP series. A firmware update should only be carried out after consultation with Beckhoff support.

Storage locations

An EtherCAT slave stores operating data in up to 3 locations:

- Depending on functionality and performance EtherCAT slaves have one or several local controllers for processing I/O data. The corresponding program is the so-called **firmware** in *.efw format.
- In some EtherCAT slaves the EtherCAT communication may also be integrated in these controllers. In this case the controller is usually a so-called **FPGA** chip with *.rbf firmware.
- In addition, each EtherCAT slave has a memory chip, a so-called **ESI-EEPROM**, for storing its own device description (ESI: EtherCAT Slave Information). On power-up this description is loaded and the EtherCAT communication is set up accordingly. The device description is available from the download area of the Beckhoff website at (<http://www.beckhoff.de>). All ESI files are accessible there as zip files.

Customers can access the data via the EtherCAT fieldbus and its communication mechanisms. Acyclic mailbox communication or register access to the ESC is used for updating or reading of these data.

The TwinCAT System Manager offers mechanisms for programming all 3 parts with new data, if the slave is set up for this purpose. Generally the slave does not check whether the new data are suitable, i.e. it may no longer be able to operate if the data are unsuitable.

Simplified update by bundle firmware

The update using so-called **bundle firmware** is more convenient: in this case the controller firmware and the ESI description are combined in a *.efw file; during the update both the firmware and the ESI are changed in the terminal. For this to happen it is necessary

- for the firmware to be in a packed format: recognizable by the file name, which also contains the revision number, e.g. ELxxx-xxx_REV0016_SW01.efw
- for password=1 to be entered in the download dialog. If password=0 (default setting) only the firmware update is carried out, without an ESI update.
- for the device to support this function. The function usually cannot be retrofitted; it is a component of many new developments from year of manufacture 2016.

Following the update, its success should be verified

- ESI/Revision: e.g. by means of an online scan in TwinCAT ConfigMode/FreeRun – this is a convenient way to determine the revision
- Firmware: e.g. by looking in the online CoE of the device

NOTE

Risk of damage to the device!

Note the following when downloading new device files

- Firmware downloads to an EtherCAT device must not be interrupted
- Flawless EtherCAT communication must be ensured. CRC errors or LostFrames must be avoided.
- The power supply must adequately dimensioned. The signal level must meet the specification.

In the event of malfunctions during the update process the EtherCAT device may become unusable and require re-commissioning by the manufacturer.

7.3.1 Device description ESI file/XML

NOTE

Attention regarding update of the ESI description/EEPROM

Some slaves have stored calibration and configuration data from the production in the EEPROM. These are irretrievably overwritten during an update.

The ESI device description is stored locally on the slave and loaded on start-up. Each device description has a unique identifier consisting of slave name (9 characters/digits) and a revision number (4 digits). Each slave configured in the System Manager shows its identifier in the EtherCAT tab:

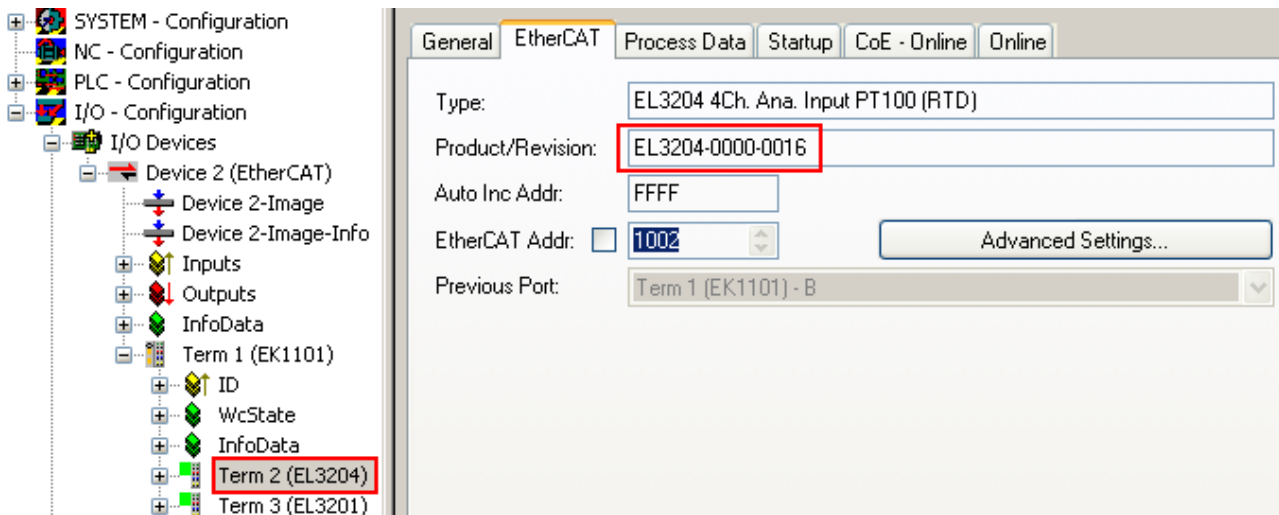

Fig. 142: Device identifier consisting of name EL3204-0000 and revision -0016

The configured identifier must be compatible with the actual device description used as hardware, i.e. the description which the slave has loaded on start-up (in this case EL3204). Normally the configured revision must be the same or lower than that actually present in the terminal network.

For further information on this, please refer to the [EtherCAT system documentation](#).

i Update of XML/ESI description

The device revision is closely linked to the firmware and hardware used. Incompatible combinations lead to malfunctions or even final shutdown of the device. Corresponding updates should only be carried out in consultation with Beckhoff support.

Display of ESI slave identifier

The simplest way to ascertain compliance of configured and actual device description is to scan the EtherCAT boxes in TwinCAT mode Config/FreeRun:

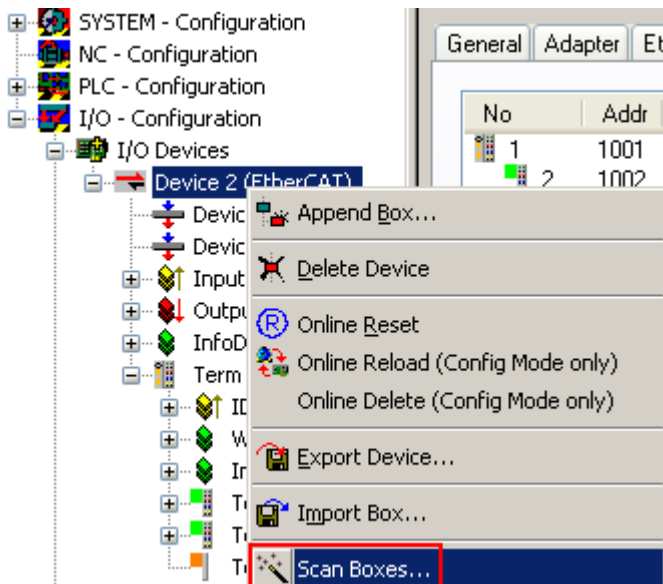

Fig. 143: Scan the subordinate field by right-clicking on the EtherCAT device

If the found field matches the configured field, the display shows



Fig. 144: Configuration is identical

otherwise a change dialog appears for entering the actual data in the configuration.

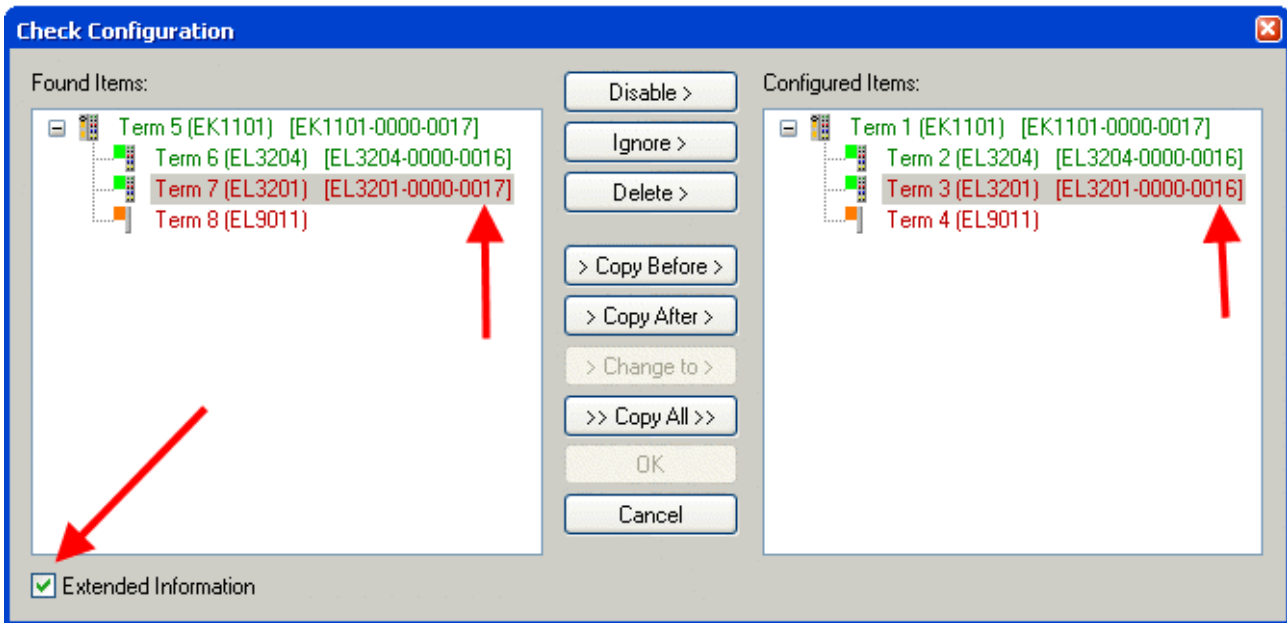

Fig. 145: Change dialog

In this example in Fig. *Change dialog*, an EL3201-0000-0017 was found, while an EL3201-0000-0016 was configured. In this case the configuration can be adapted with the *Copy Before* button. The *Extended Information* checkbox must be set in order to display the revision.

Changing the ESI slave identifier

The ESI/EEPROM identifier can be updated as follows under TwinCAT:

- Trouble-free EtherCAT communication must be established with the slave.
- The state of the slave is irrelevant.
- Right-clicking on the slave in the online display opens the *EEPROM Update* dialog, Fig. *EEPROM Update*

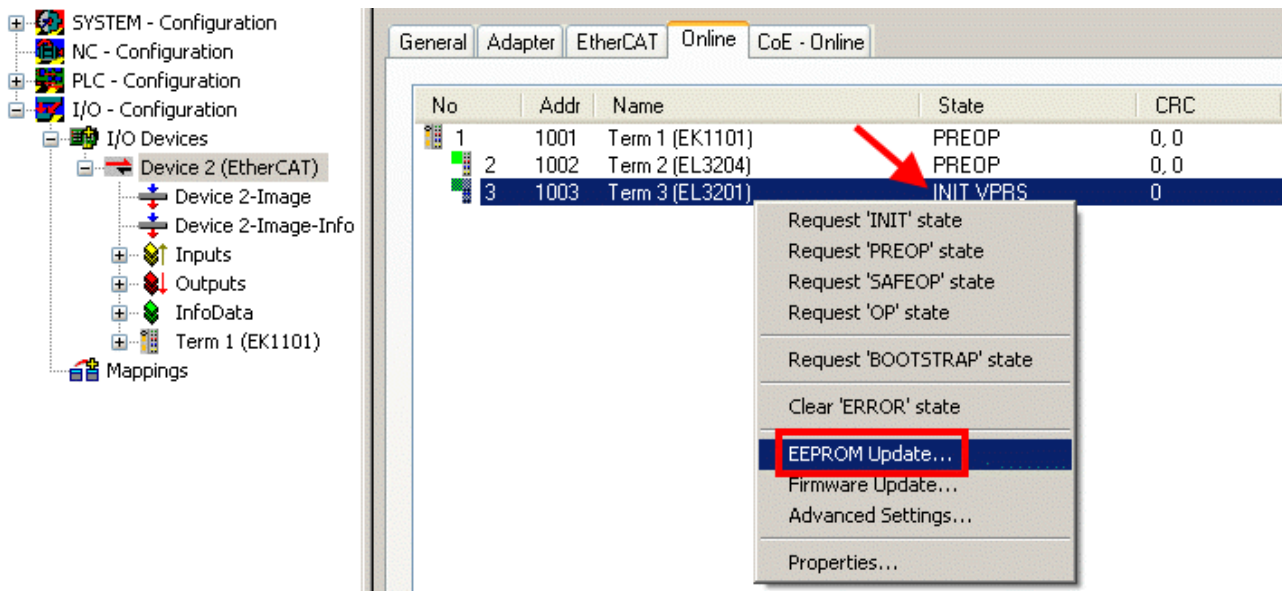

Fig. 146: EEPROM Update

The new ESI description is selected in the following dialog, see Fig. *Selecting the new ESI*. The checkbox *Show Hidden Devices* also displays older, normally hidden versions of a slave.

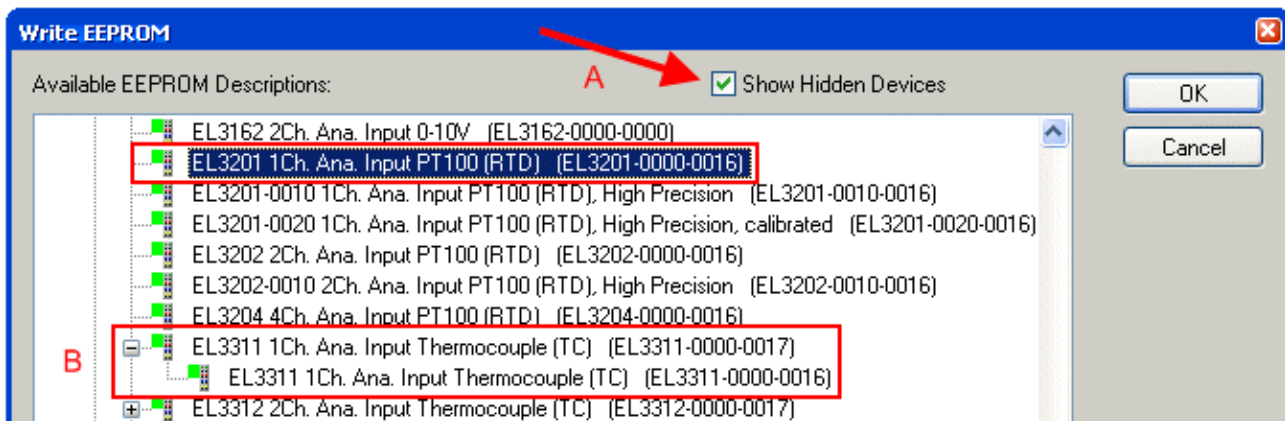

Fig. 147: Selecting the new ESI

A progress bar in the System Manager shows the progress. Data are first written, then verified.

● The change only takes effect after a restart.

i Most EtherCAT devices read a modified ESI description immediately or after startup from the INIT. Some communication settings such as distributed clocks are only read during power-on. The EtherCAT slave therefore has to be switched off briefly in order for the change to take effect.

7.3.2 Firmware explanation

Determining the firmware version

Determining the version on laser inscription

Beckhoff EtherCAT slaves feature serial numbers applied by laser. The serial number has the following structure: **KK YY FF HH**

KK - week of production (CW, calendar week)

YY - year of production

FF - firmware version

HH - hardware version

Example with ser. no.: 12 10 03 02:

- 12 - week of production 12
- 10 - year of production 2010
- 03 - firmware version 03
- 02 - hardware version 02

Determining the version via the System Manager

The TwinCAT System Manager shows the version of the controller firmware if the master can access the slave online. Click on the E-Bus Terminal whose controller firmware you want to check (in the example terminal 2 (EL3204)) and select the tab *CoE Online* (CAN over EtherCAT).

i CoE Online and Offline CoE

Two CoE directories are available:

- **online**: This is offered in the EtherCAT slave by the controller, if the EtherCAT slave supports this. This CoE directory can only be displayed if a slave is connected and operational.
- **offline**: The EtherCAT Slave Information ESI/XML may contain the default content of the CoE. This CoE directory can only be displayed if it is included in the ESI (e.g. "Beckhoff EL5xxx.xml").

The Advanced button must be used for switching between the two views.

In Fig. *Display of EL3204 firmware version* the firmware version of the selected EL3204 is shown as 03 in CoE entry 0x100A.

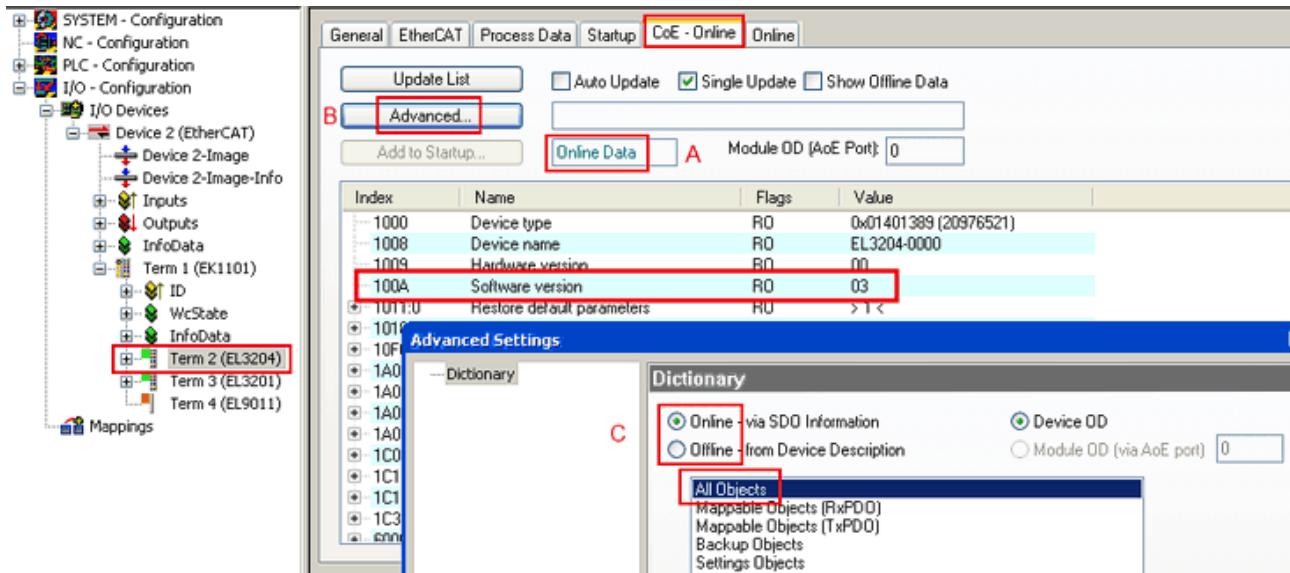

Fig. 148: Display of EL3204 firmware version

In (A) TwinCAT 2.11 shows that the Online CoE directory is currently displayed. If this is not the case, the Online directory can be loaded via the *Online* option in Advanced Settings (B) and double-clicking on *AllObjects*.

7.3.3 Updating controller firmware *.efw

i CoE directory

The Online CoE directory is managed by the controller and stored in a dedicated EEPROM, which is generally not changed during a firmware update.

Switch to the *Online* tab to update the controller firmware of a slave, see Fig. *Firmware Update*.

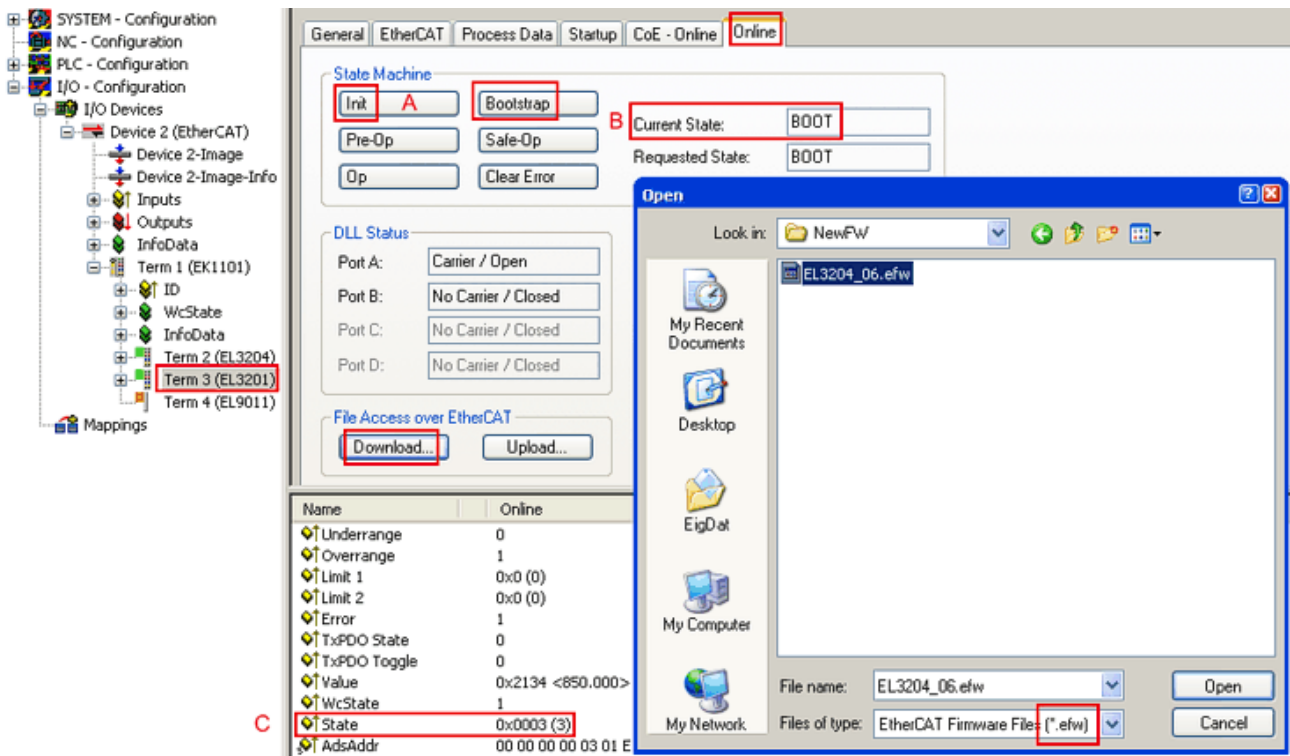
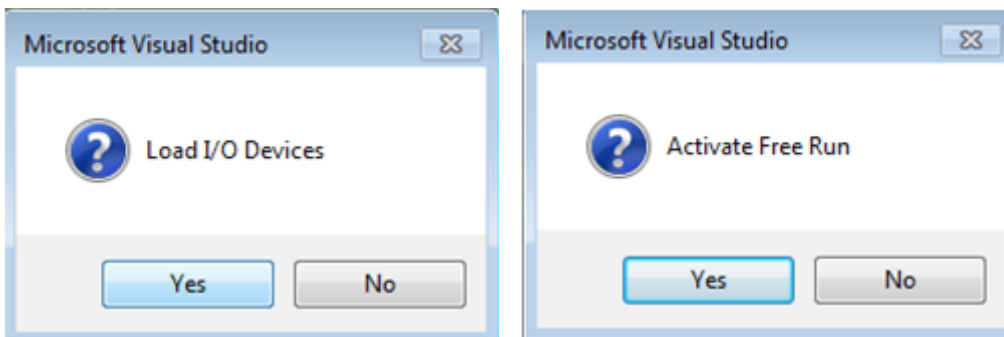

Fig. 149: Firmware Update

Proceed as follows, unless instructed otherwise by Beckhoff support. Valid for TwinCAT 2 and 3 as EtherCAT master.

- Switch TwinCAT system to ConfigMode/FreeRun with cycle time ≥ 1 ms (default in ConfigMode is 4 ms). A FW-Update during real time operation is not recommended.



- Switch EtherCAT Master to PreOP

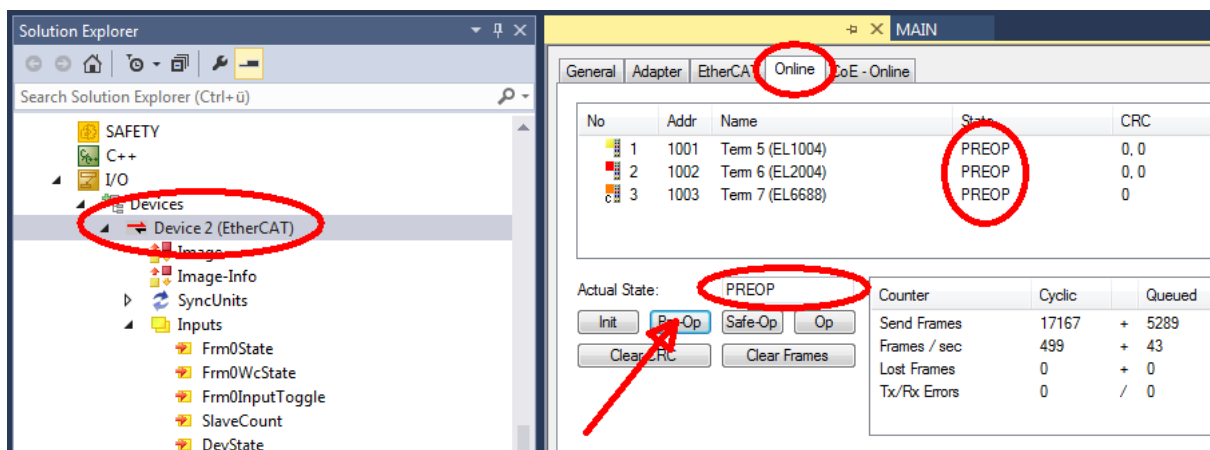

- Switch slave to INIT (A)
- Switch slave to BOOTSTRAP

- Check the current status (B, C)
- Download the new *efw file (wait until it ends). A pass word will not be necessary usually.

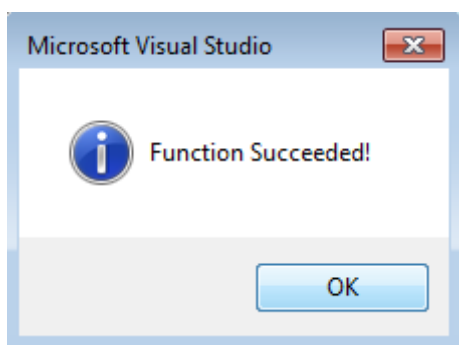

- After the download switch to INIT, then PreOP
- Switch off the slave briefly (don't pull under voltage!)
- Check within CoE 0x100A, if the FW status was correctly overtaken.

7.3.4 FPGA firmware *.rbf

If an FPGA chip deals with the EtherCAT communication an update may be accomplished via an *.rbf file.

- Controller firmware for processing I/O signals
- FPGA firmware for EtherCAT communication (only for terminals with FPGA)

The firmware version number included in the terminal serial number contains both firmware components. If one of these firmware components is modified this version number is updated.

Determining the version via the System Manager

The TwinCAT System Manager indicates the FPGA firmware version. Click on the Ethernet card of your EtherCAT strand (Device 2 in the example) and select the *Online* tab.

The *Reg:0002* column indicates the firmware version of the individual EtherCAT devices in hexadecimal and decimal representation.

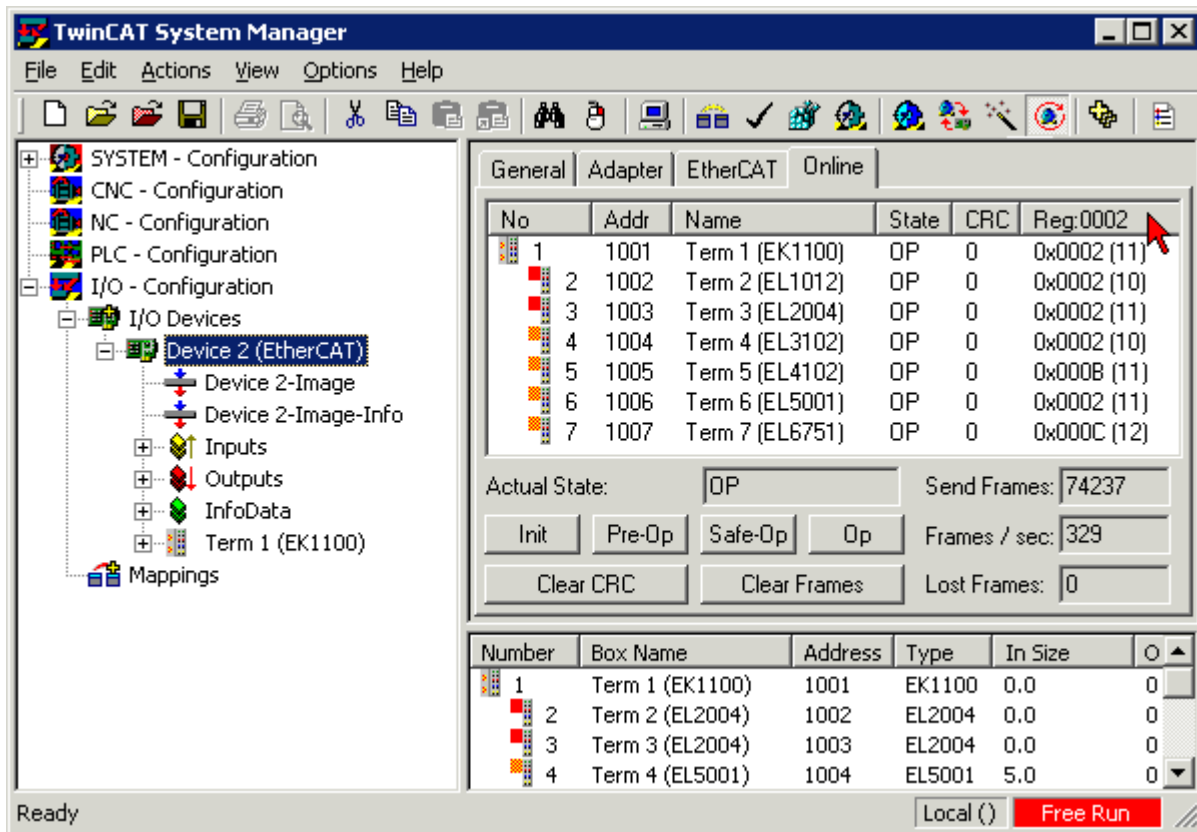
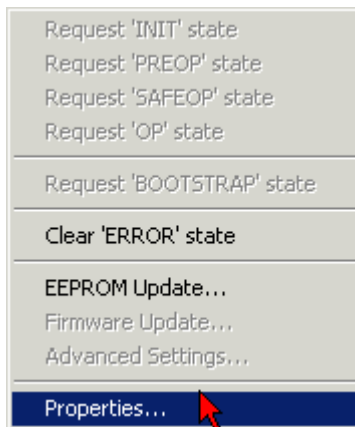

Fig. 150: FPGA firmware version definition

If the column *Reg:0002* is not displayed, right-click the table header and select *Properties* in the context menu.

Fig. 151: Context menu *Properties*

The *Advanced Settings* dialog appears where the columns to be displayed can be selected. Under *Diagnosis/Online View* select the '*0002 ETxxx Build*' check box in order to activate the FPGA firmware version display.

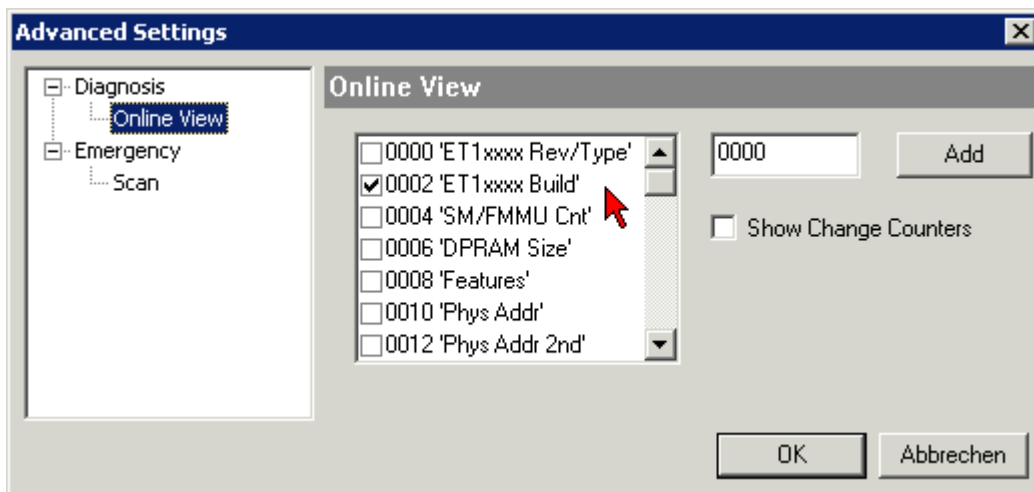

Fig. 152: Dialog *Advanced Settings*

Update

For updating the FPGA firmware

- of an EtherCAT coupler the coupler must have FPGA firmware version 11 or higher;
- of an E-Bus Terminal the terminal must have FPGA firmware version 10 or higher.

Older firmware versions can only be updated by the manufacturer!

Updating an EtherCAT device

The following sequence order have to be met if no other specifications are given (e.g. by the Beckhoff support):

- Switch TwinCAT system to ConfigMode/FreeRun with cycle time ≥ 1 ms (default in ConfigMode is 4 ms). A FW-Update during real time operation is not recommended.

- In the TwinCAT System Manager select the terminal for which the FPGA firmware is to be updated (in the example: Terminal 5: EL5001) and click the *Advanced Settings* button in the *EtherCAT* tab:

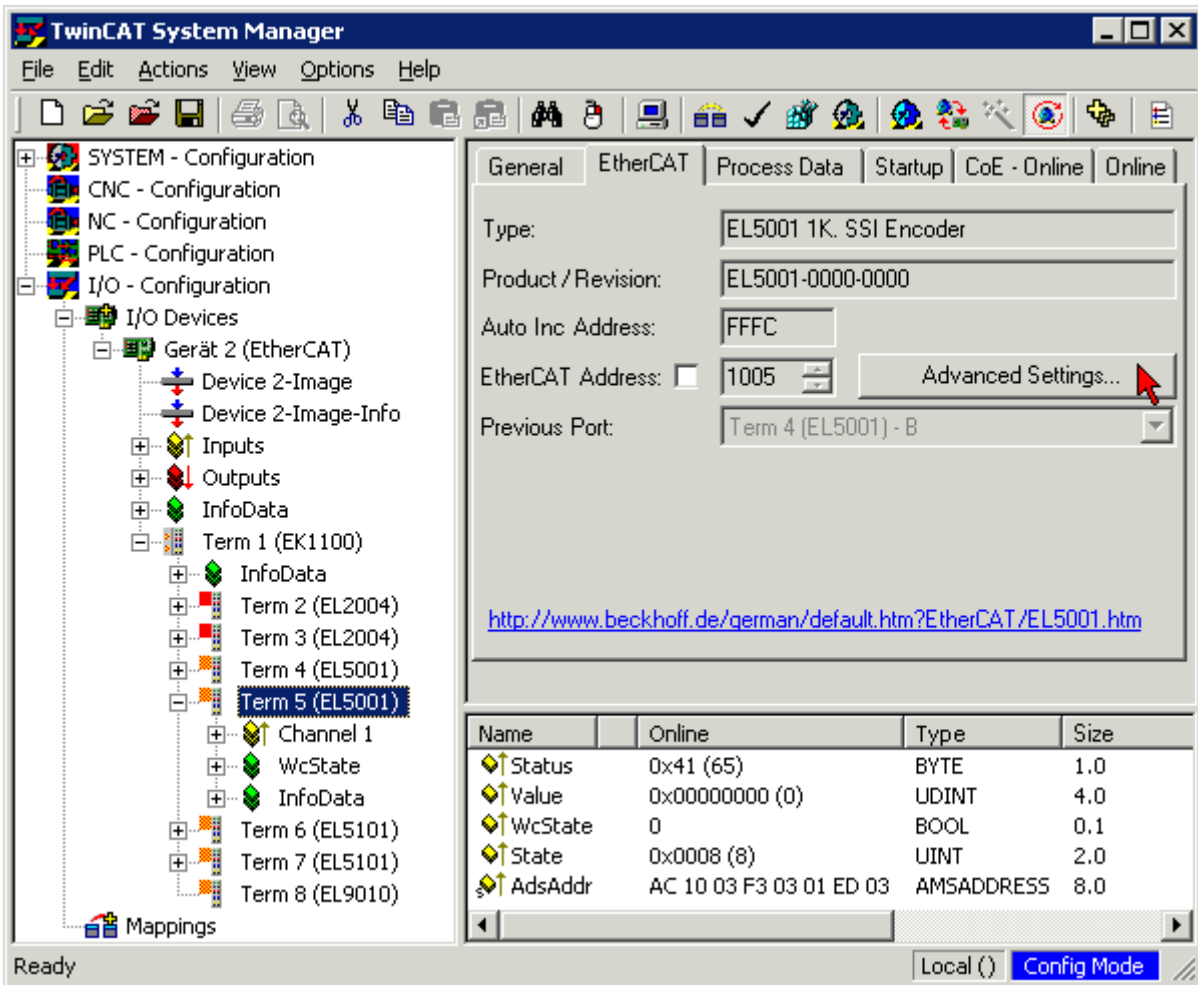

- The *Advanced Settings* dialog appears. Under *ESC Access/E²PROM/FPGA* click on *Write FPGA* button:

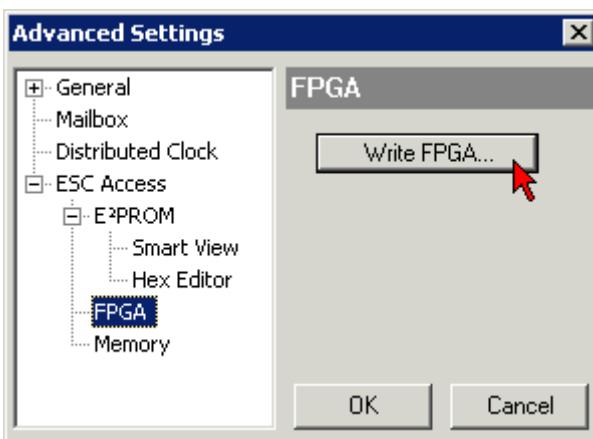

- Select the file (*.rbf) with the new FPGA firmware, and transfer it to the EtherCAT device:

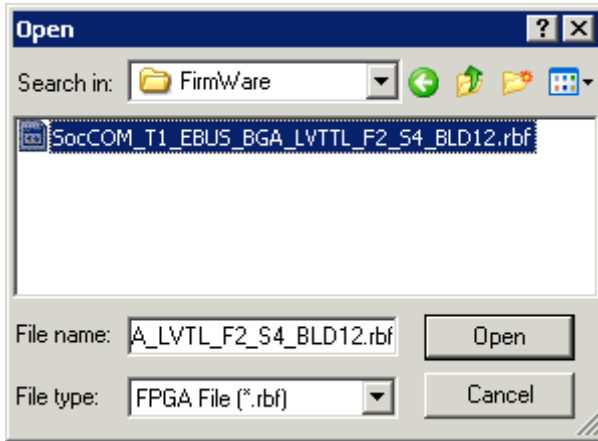

- Wait until download ends
- Switch slave current less for a short time (don't pull under voltage!). In order to activate the new FPGA firmware a restart (switching the power supply off and on again) of the EtherCAT device is required.
- Check the new FPGA status

NOTE

Risk of damage to the device!

A download of firmware to an EtherCAT device must not be interrupted in any case! If you interrupt this process by switching off power supply or disconnecting the Ethernet link, the EtherCAT device can only be recommissioned by the manufacturer!

7.3.5 Simultaneous updating of several EtherCAT devices

The firmware and ESI descriptions of several devices can be updated simultaneously, provided the devices have the same firmware file/ESI.

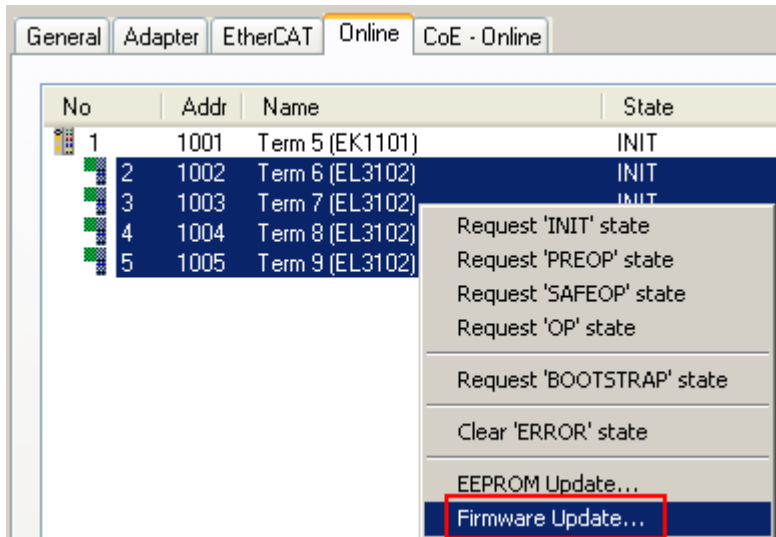

Fig. 153: Multiple selection and firmware update

Select the required slaves and carry out the firmware update in BOOTSTRAP mode as described above.

7.4 Restoring the delivery state

To restore the delivery state for backup objects in ELxxx terminals, the CoE object Restore default parameters, *SubIndex 001* can be selected in the TwinCAT System Manager (Config mode) (see Fig. *Selecting the Restore default parameters PDO*)

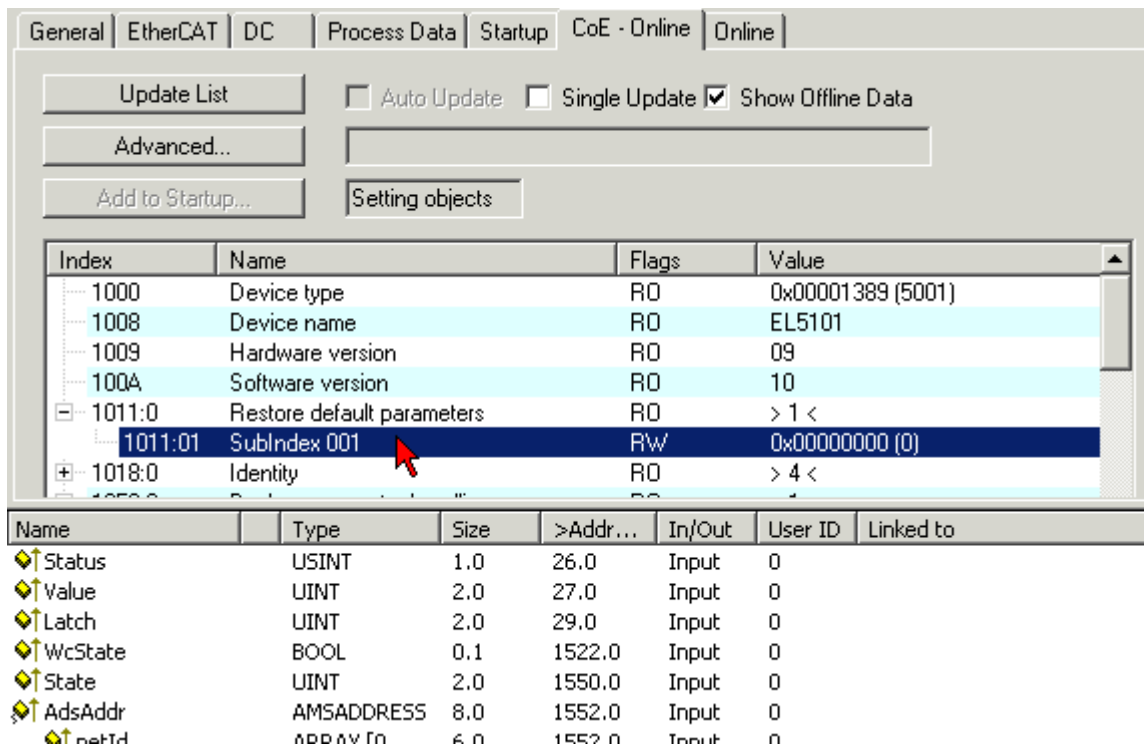

Fig. 154: Selecting the "Restore default parameters" PDO

Double-click on SubIndex 001 to enter the Set Value dialog. Enter the value **1684107116** in field *Dec* or the value **0x64616F6C** in field *Hex* and confirm with *OK* (Fig. *Entering a restore value in the Set Value dialog*). All backup objects are reset to the delivery state.

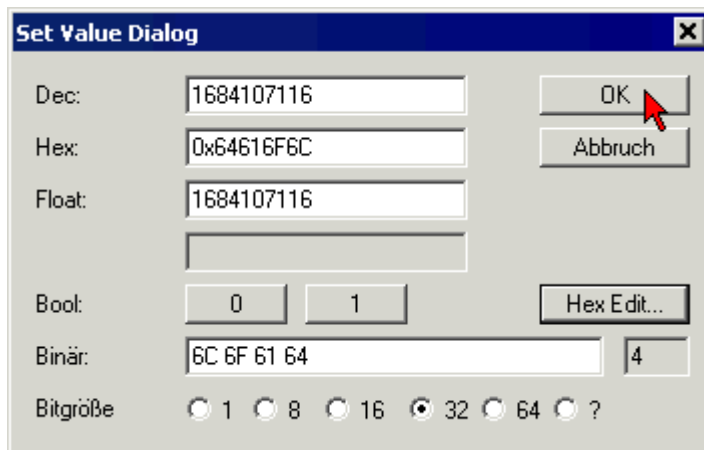

Fig. 155: Entering a restore value in the Set Value dialog

● Alternative restore value

i In some older terminals the backup objects can be switched with an alternative restore value: Decimal value: 1819238756, Hexadecimal value: 0x6C6F6164An incorrect entry for the restore value has no effect.

7.5 Support and Service

Beckhoff and their partners around the world offer comprehensive support and service, making available fast and competent assistance with all questions related to Beckhoff products and system solutions.

Beckhoff's branch offices and representatives

Please contact your Beckhoff branch office or representative for local support and service on Beckhoff products!

The addresses of Beckhoff's branch offices and representatives round the world can be found on her internet pages:

<http://www.beckhoff.com>

You will also find further documentation for Beckhoff components there.

Beckhoff Headquarters

Beckhoff Automation GmbH & Co. KG

Huelshorstweg 20
33415 Verl
Germany

Phone:	+49(0)5246/963-0
Fax:	+49(0)5246/963-198
e-mail:	info@beckhoff.com

Beckhoff Support

Support offers you comprehensive technical assistance, helping you not only with the application of individual Beckhoff products, but also with other, wide-ranging services:

- support
- design, programming and commissioning of complex automation systems
- and extensive training program for Beckhoff system components

Hotline:	+49(0)5246/963-157
Fax:	+49(0)5246/963-9157
e-mail:	support@beckhoff.com

Beckhoff Service

The Beckhoff Service Center supports you in all matters of after-sales service:

- on-site service
- repair service
- spare parts service
- hotline service

Hotline:	+49(0)5246/963-460
Fax:	+49(0)5246/963-479
e-mail:	service@beckhoff.com

List of figures

Fig. 1	EL5021 EL terminal, standard IP20 IO device with serial/ batch number and revision ID (since 2014/01).....	8
Fig. 2	EK1100 EtherCAT coupler, standard IP20 IO device with serial/ batch number.....	9
Fig. 3	CU2016 switch with serial/ batch number.....	9
Fig. 4	EL3202-0020 with serial/ batch number 26131006 and unique ID-number 204418	9
Fig. 5	EP1258-00001 IP67 EtherCAT Box with batch number/ date code 22090101 and unique serial number 158102.....	10
Fig. 6	EP1908-0002 IP67 EtherCAT Safety Box with batch number/ date code 071201FF and unique serial number 00346070	10
Fig. 7	EL2904 IP20 safety terminal with batch number/ date code 50110302 and unique serial number 00331701.....	10
Fig. 8	ELM3604-0002 terminal with unique ID number (QR code) 100001051 and serial/ batch number 44160201.....	10
Fig. 9	EL6861	11
Fig. 10	System manager current calculation	14
Fig. 11	EtherCAT tab -> Advanced Settings -> Behavior -> Watchdog	15
Fig. 12	States of the EtherCAT State Machine.....	17
Fig. 13	"CoE Online " tab	19
Fig. 14	Startup list in the TwinCAT System Manager	20
Fig. 15	Offline list.....	21
Fig. 16	Online list	21
Fig. 17	Spring contacts of the Beckhoff I/O components.....	23
Fig. 18	Attaching on mounting rail	24
Fig. 19	Disassembling of terminal.....	25
Fig. 20	Power contact on left side.....	26
Fig. 21	Recommended distances for standard installation position	27
Fig. 22	Other installation positions	28
Fig. 23	Correct positioning.....	28
Fig. 24	Incorrect positioning.....	29
Fig. 25	LEDs and serial interface.....	30
Fig. 26	Relationship between user side (commissioning) and installation.....	36
Fig. 27	Control configuration with Embedded PC, input (EL1004) and output (EL2008)	37
Fig. 28	Initial TwinCAT 2 user interface.....	37
Fig. 29	Selection of the target system	38
Fig. 30	Specify the PLC for access by the TwinCAT System Manager: selection of the target system ..	38
Fig. 31	Select "Scan Devices..."	39
Fig. 32	Automatic detection of I/O devices: selection the devices to be integrated.....	39
Fig. 33	Mapping of the configuration in the TwinCAT 2 System Manager.....	40
Fig. 34	Reading of individual terminals connected to a device.....	40
Fig. 35	TwinCAT PLC Control after startup	41
Fig. 36	Sample program with variables after a compile process (without variable integration).....	42
Fig. 37	Appending the TwinCAT PLC Control project	42
Fig. 38	PLC project integrated in the PLC configuration of the System Manager	43
Fig. 39	Creating the links between PLC variables and process objects.....	43
Fig. 40	Selecting PDO of type BOOL	44
Fig. 41	Selecting several PDOs simultaneously: activate "Continuous" and "All types".....	44

Fig. 42	Application of a "Goto Link" variable, using "MAIN.bEL1004_Ch4" as a sample	45
Fig. 43	Choose target system (remote)	46
Fig. 44	PLC Control logged in, ready for program startup	47
Fig. 45	Initial TwinCAT 3 user interface	48
Fig. 46	Create new TwinCAT project	48
Fig. 47	New TwinCAT3 project in the project folder explorer	49
Fig. 48	Selection dialog: Choose the target system	49
Fig. 49	Specify the PLC for access by the TwinCAT System Manager: selection of the target system ..	50
Fig. 50	Select "Scan"	50
Fig. 51	Automatic detection of I/O devices: selection the devices to be integrated	51
Fig. 52	Mapping of the configuration in VS shell of the TwinCAT3 environment	51
Fig. 53	Reading of individual terminals connected to a device	52
Fig. 54	Adding the programming environment in "PLC"	53
Fig. 55	Specifying the name and directory for the PLC programming environment	53
Fig. 56	Initial "Main" program of the standard PLC project	54
Fig. 57	Sample program with variables after a compile process (without variable integration)	55
Fig. 58	Start program compilation	55
Fig. 59	Creating the links between PLC variables and process objects	56
Fig. 60	Selecting PDO of type BOOL	56
Fig. 61	Selecting several PDOs simultaneously: activate "Continuous" and "All types"	57
Fig. 62	Application of a "Goto Link" variable, using "MAIN.bEL1004_Ch4" as a sample	57
Fig. 63	TwinCAT development environment (VS shell): logged-in, after program startup	58
Fig. 64	System Manager "Options" (TwinCAT 2)	60
Fig. 65	Call up under VS Shell (TwinCAT 3)	60
Fig. 66	Overview of network interfaces	60
Fig. 67	EtherCAT device properties(TwinCAT 2): click on „Compatible Devices...“ of tab “Adapter”	61
Fig. 68	Windows properties of the network interface	61
Fig. 69	Exemplary correct driver setting for the Ethernet port	62
Fig. 70	Incorrect driver settings for the Ethernet port	63
Fig. 71	TCP/IP setting for the Ethernet port	64
Fig. 72	Identifier structure	65
Fig. 73	OnlineDescription information window (TwinCAT 2)	66
Fig. 74	Information window OnlineDescription (TwinCAT 3)	66
Fig. 75	File OnlineDescription.xml created by the System Manager	67
Fig. 76	Indication of an online recorded ESI of EL2521 as an example	67
Fig. 77	Information window for faulty ESI file (left: TwinCAT 2; right: TwinCAT 3)	67
Fig. 78	Using the ESI Updater (>= TwinCAT 2.11)	69
Fig. 79	Using the ESI Updater (TwinCAT 3)	69
Fig. 80	Append EtherCAT device (left: TwinCAT 2; right: TwinCAT 3)	70
Fig. 81	Selecting the EtherCAT connection (TwinCAT 2.11, TwinCAT 3)	70
Fig. 82	Selecting the Ethernet port	70
Fig. 83	EtherCAT device properties (TwinCAT 2)	71
Fig. 84	Appending EtherCAT devices (left: TwinCAT 2; right: TwinCAT 3)	71
Fig. 85	Selection dialog for new EtherCAT device	72
Fig. 86	Display of device revision	72
Fig. 87	Display of previous revisions	73

Fig. 88	Name/revision of the terminal	73
Fig. 89	EtherCAT terminal in the TwinCAT tree (left: TwinCAT 2; right: TwinCAT 3).....	74
Fig. 90	Differentiation local/target system (left: TwinCAT 2; right: TwinCAT 3).....	75
Fig. 91	Scan Devices (left: TwinCAT 2; right: TwinCAT 3).....	75
Fig. 92	Note for automatic device scan (left: TwinCAT 2; right: TwinCAT 3).....	75
Fig. 93	Detected Ethernet devices	76
Fig. 94	Example default state	76
Fig. 95	Installing EthetCAT terminal with revision -1018	77
Fig. 96	Detection of EtherCAT terminal with revision -1019.....	77
Fig. 97	Scan query after automatic creation of an EtherCAT device (left: TwinCAT 2; right: TwinCAT 3)	77
Fig. 98	Manual triggering of a device scan on a specified EtherCAT device (left: TwinCAT 2; right: TwinCAT 3).....	78
Fig. 99	Scan progressexemplary by TwinCAT 2	78
Fig. 100	Config/FreeRun query (left: TwinCAT 2; right: TwinCAT 3).....	78
Fig. 101	Displaying of "Free Run" and "Config Mode" toggling right below in the status bar	78
Fig. 102	TwinCAT can also be switched to this state by using a button (left: TwinCAT 2; right: TwinCAT 3)	78
Fig. 103	Online display example	79
Fig. 104	Faulty identification	79
Fig. 105	Identical configuration (left: TwinCAT 2; right: TwinCAT 3).....	80
Fig. 106	Correction dialog	80
Fig. 107	Name/revision of the terminal	81
Fig. 108	Correction dialog with modifications	82
Fig. 109	Dialog "Change to Compatible Type..." (left: TwinCAT 2; right: TwinCAT 3).....	82
Fig. 110	TwinCAT 2 Dialog Change to Alternative Type	82
Fig. 111	Branch element as terminal EL3751.....	83
Fig. 112	"General" tab.....	83
Fig. 113	„EtherCAT“ tab.....	84
Fig. 114	"Process Data" tab.....	85
Fig. 115	Configuring the process data.....	86
Fig. 116	„Startup“ tab.....	87
Fig. 117	"CoE – Online" tab	88
Fig. 118	Dialog "Advanced settings".....	89
Fig. 119	„Online“ tab	90
Fig. 120	"DC" tab (Distributed Clocks).....	91
Fig. 121	Selection of the diagnostic information of an EtherCAT Slave	93
Fig. 122	Basic EtherCAT Slave Diagnosis in the PLC.....	94
Fig. 123	EL3102, CoE directory	96
Fig. 124	Example of commissioning aid for a EL3204	97
Fig. 125	Default behaviour of the System Manager	98
Fig. 126	Default target state in the Slave	98
Fig. 127	PLC function blocks	99
Fig. 128	Illegally exceeding the E-Bus current	100
Fig. 129	Warning message for exceeding E-Bus current	100
Fig. 130	Inserting BACnet MS/TP Device in TwinCAT	101
Fig. 131	Selection of the desired terminal	102

Fig. 132	Setting of the MS/TP interface	103
Fig. 133	Dialog „Scanning BACnet Devices“	104
Fig. 134	TwinCAT3: Ethernet Capture Start	105
Fig. 135	TwinCAT3: Ethernet Capture Stop	105
Fig. 136	Recorded file „capture*.pcap“	106
Fig. 137	Display in Wireshark	106
Fig. 138	Scheme of BACnet Internetwork	106
Fig. 139	Setting of the routing information.....	108
Fig. 140	Setting of the network number	109
Fig. 141	Make settings for all networks	110
Fig. 142	Device identifier consisting of name EL3204-0000 and revision -0016	120
Fig. 143	Scan the subordinate field by right-clicking on the EtherCAT device	120
Fig. 144	Configuration is identical	121
Fig. 145	Change dialog	121
Fig. 146	EEPROM Update	122
Fig. 147	Selecting the new ESI.....	122
Fig. 148	Display of EL3204 firmware version	123
Fig. 149	Firmware Update	124
Fig. 150	FPGA firmware version definition	126
Fig. 151	Context menu Properties	126
Fig. 152	Dialog Advanced Settings	127
Fig. 153	Multiple selection and firmware update	129
Fig. 154	Selecting the "Restore default parameters" PDO	130
Fig. 155	Entering a restore value in the Set Value dialog.....	130