



Documentation

KL1859

HD Bus Terminal, 8-channel digital input + 8-channel digital output 24 V DC

Version: 1.0.0
Date: 2016-08-10

BECKHOFF

Table of contents

1 Foreword	4
1.1 Notes on the documentation	4
1.2 Safety instructions	5
1.3 Documentation Issue Status	6
2 Product overview	7
2.1 Introduction	7
2.2 Technical data	8
3 Presentation KL1859 within TwinCAT	9
4 Mounting and wiring	10
4.1 Installation on mounting rails	10
4.2 Connection system	12
4.3 ATEX - Special conditions	15
4.4 ATEX Documentation	16
4.5 Connection and LED displays	17
5 Appendix	19
5.1 Support and Service	19

1 Foreword

1.1 Notes on the documentation

Intended audience

This description is only intended for the use of trained specialists in control and automation engineering who are familiar with the applicable national standards.

It is essential that the following notes and explanations are followed when installing and commissioning these components.

The responsible staff must ensure that the application or use of the products described satisfy all the requirements for safety, including all the relevant laws, regulations, guidelines and standards.

Disclaimer

The documentation has been prepared with care. The products described are, however, constantly under development. For that reason the documentation is not in every case checked for consistency with performance data, standards or other characteristics. In the event that it contains technical or editorial errors, we retain the right to make alterations at any time and without warning. No claims for the modification of products that have already been supplied may be made on the basis of the data, diagrams and descriptions in this documentation.

Trademarks

Beckhoff®, TwinCAT®, EtherCAT®, Safety over EtherCAT®, TwinSAFE®, XFC® and XTS® are registered trademarks of and licensed by Beckhoff Automation GmbH.

Other designations used in this publication may be trademarks whose use by third parties for their own purposes could violate the rights of the owners.

Patent Pending

The EtherCAT Technology is covered, including but not limited to the following patent applications and patents: EP1590927, EP1789857, DE102004044764, DE102007017835 with corresponding applications or registrations in various other countries.

The TwinCAT Technology is covered, including but not limited to the following patent applications and patents: EP0851348, US6167425 with corresponding applications or registrations in various other countries.



EtherCAT® is registered trademark and patented technology, licensed by Beckhoff Automation GmbH, Germany

Copyright

© Beckhoff Automation GmbH & Co. KG, Germany.

The reproduction, distribution and utilization of this document as well as the communication of its contents to others without express authorization are prohibited.

Offenders will be held liable for the payment of damages. All rights reserved in the event of the grant of a patent, utility model or design.

1.2 Safety instructions

Safety regulations

Please note the following safety instructions and explanations!
 Product-specific safety instructions can be found on following pages or in the areas mounting, wiring, commissioning etc.

Exclusion of liability





All the components are supplied in particular hardware and software configurations appropriate for the application. Modifications to hardware or software configurations other than those described in the documentation are not permitted, and nullify the liability of Beckhoff Automation GmbH & Co. KG.

Personnel qualification

This description is only intended for trained specialists in control, automation and drive engineering who are familiar with the applicable national standards.

Description of symbols

In this documentation the following symbols are used with an accompanying safety instruction or note. The safety instructions must be read carefully and followed without fail!

 DANGER	<p>Serious risk of injury! Failure to follow the safety instructions associated with this symbol directly endangers the life and health of persons.</p>
 WARNING	<p>Risk of injury! Failure to follow the safety instructions associated with this symbol endangers the life and health of persons.</p>
 CAUTION	<p>Personal injuries! Failure to follow the safety instructions associated with this symbol can lead to injuries to persons.</p>
 Attention	<p>Damage to the environment or devices Failure to follow the instructions associated with this symbol can lead to damage to the environment or equipment.</p>
 Note	<p>Tip or pointer This symbol indicates information that contributes to better understanding.</p>

1.3 Documentation Issue Status

Version	Comment
1.0.0	<ul style="list-style-type: none"> • First published

Firmware and hardware versions

Documentation Version	KL1859	
	Firmware	Hardware
1.0.0	-	00

The firmware and hardware versions (delivery state) can be taken from the serial number printed on the side of the terminal.

Syntax of the serial number

Structure of the serial number: WW YY FF HH

WW - week of production (calendar week)

YY - year of production

FF - firmware version

HH - hardware version

Example with ser. no.: 40 15 1A 00:

40 - week of production 40

15 - year of production 2015

1A - firmware version 1A

00 - hardware version 00

2 Product overview

2.1 Introduction

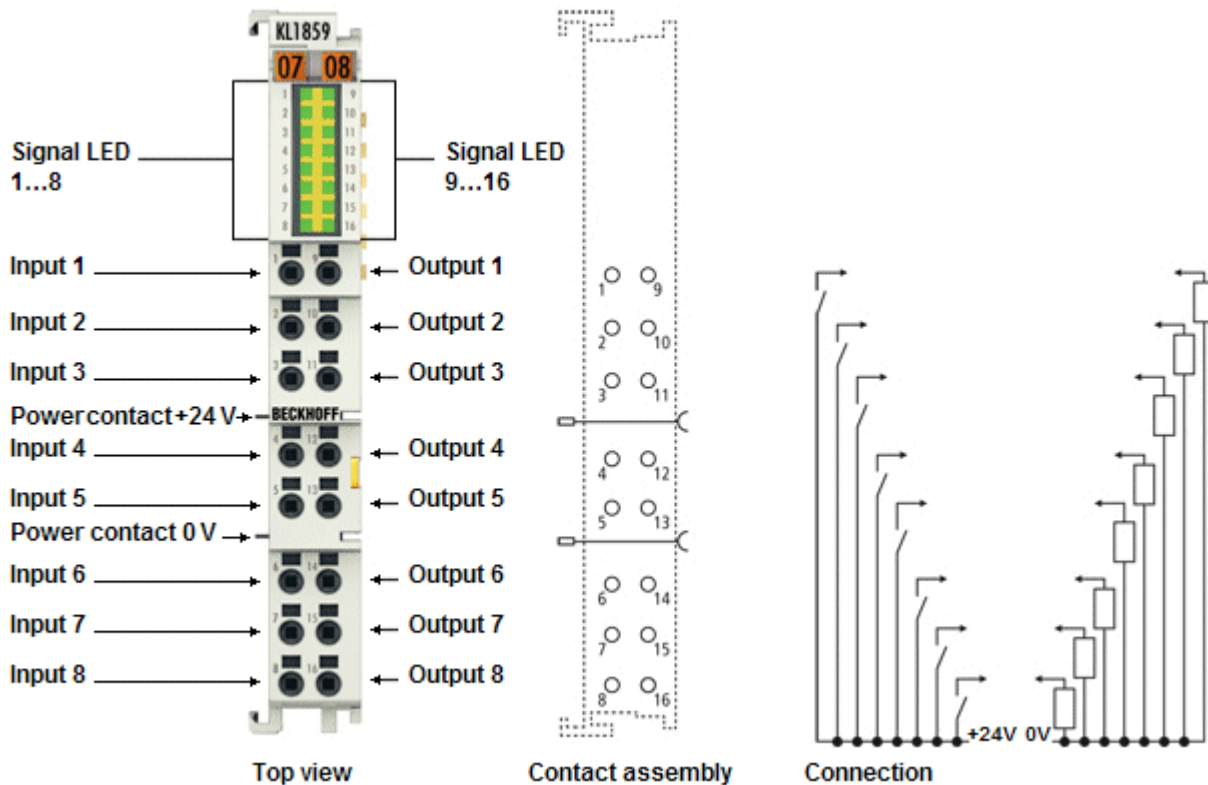

Fig. 1: KL1859

The digital KL1859 Bus Terminal combines eight digital inputs and eight digital outputs in one device. The inputs have a filter of 3.0 ms. The outputs process load currents up to 0.5 A, are short-circuit-proof and protected against polarity reversal. The signal states are displayed by LEDs.

The reference ground for all inputs is the 0 V power contact, the outputs are fed via the 24 V power contact. The conductors can be connected without tools in the case of solid wires using a direct plug-in technique.

The HD Bus Terminals (High Density) with increased packing density feature 16 connection points in the housing of a 12 mm terminal block.

2.2 Technical data

KL1859 - Technical data

Technical data	KL1859-0000
Connection technology	1-wire
Number of Inputs	8
Number of Outputs	8
Nominal voltage	24 V DC (-15 %/+20 %)
"0" signal voltage	-3...+5 V (EN 61131-2, type 1/3)
"1" signal voltage	11...30 V (EN 61131-2, type 3)
Input filter	typ. 3.0 ms
Input current	typ. 3 mA (EN 61131-2, type 3)
Current consumpt. K-bus	typ. 25 mA
Load type	ohmic, inductive, lamp load
Max. output current	0.5 A (per channel)
Reverse voltage protection	yes
Current consumption power contacts	typ. 15 mA + load
Electrical isolation	500 V (K-bus/field potential)
Bit width in the process image	8 inputs + 8 outputs
Configuration	no address or configuration setting
Dimensions (W x H x D)	approx. 15 mm x 100 mm x 70 mm (width aligned: 12 mm)
Weight	approx. 60 g
Mounting [► 10]	on 35 mm mounting rail according to EN 60715
Operating temperature	0°C ... +55°C
Storage temperature	-25°C ... +85°C
Relative humidity	95 %, no condensation
Vibration/shock resistance	conforms to EN 60068-2-6/EN 60068-2-27
EMC immunity/emission	conforms to EN 61000-6-2/EN 61000-6-4
Installation pos.	variable
Protect. class	IP20
Approvals	CE, ATEX [► 15], cULus, GL

3 Presentation KL1859 within TwinCAT

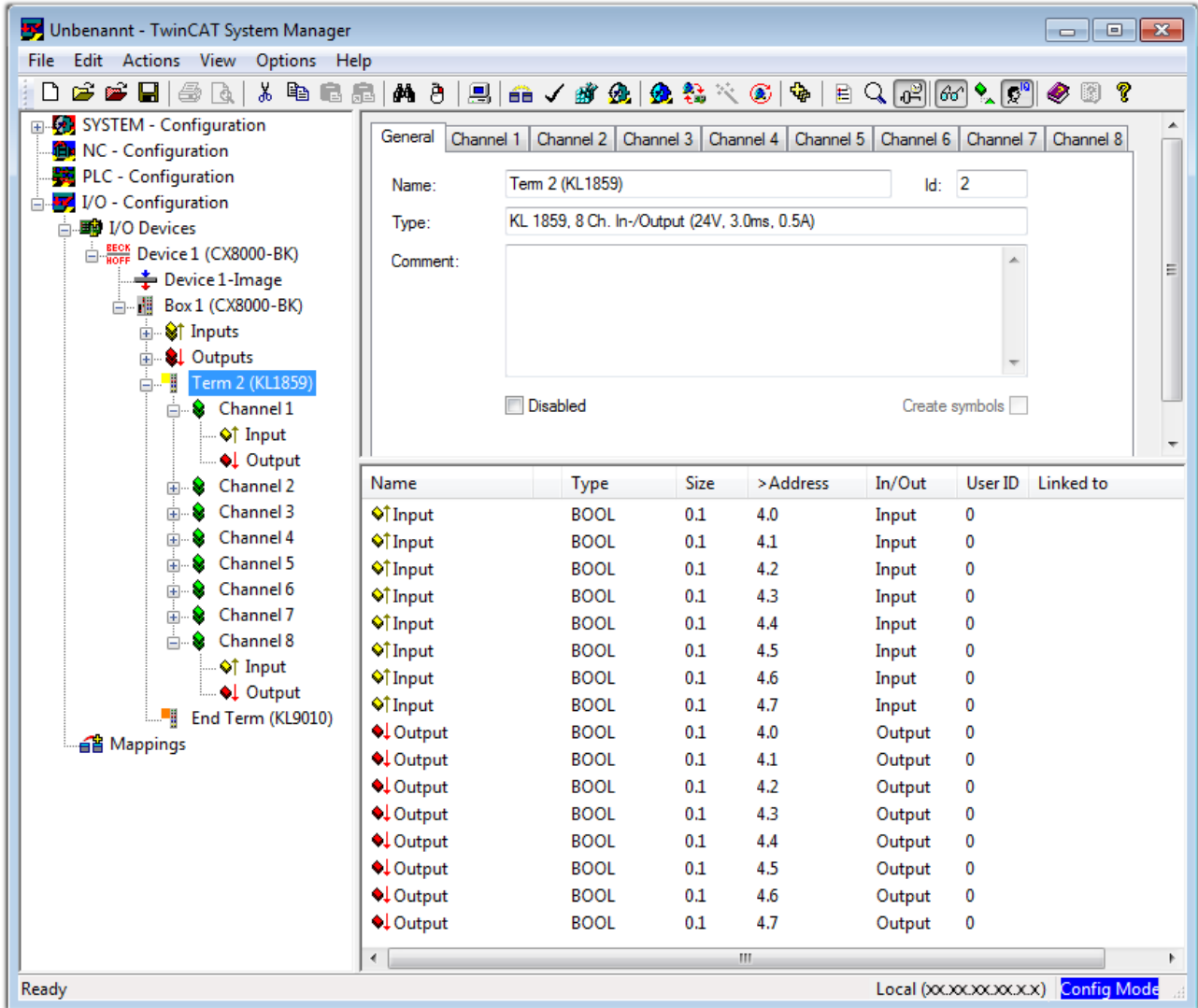

Fig. 2: KL1859 within TwinCAT 2.11

4 Mounting and wiring

4.1 Installation on mounting rails



WARNING

Risk of electric shock and damage of device!

Bring the bus terminal system into a safe, powered down state before starting installation, disassembly or wiring of the Bus Terminals!

Assembly

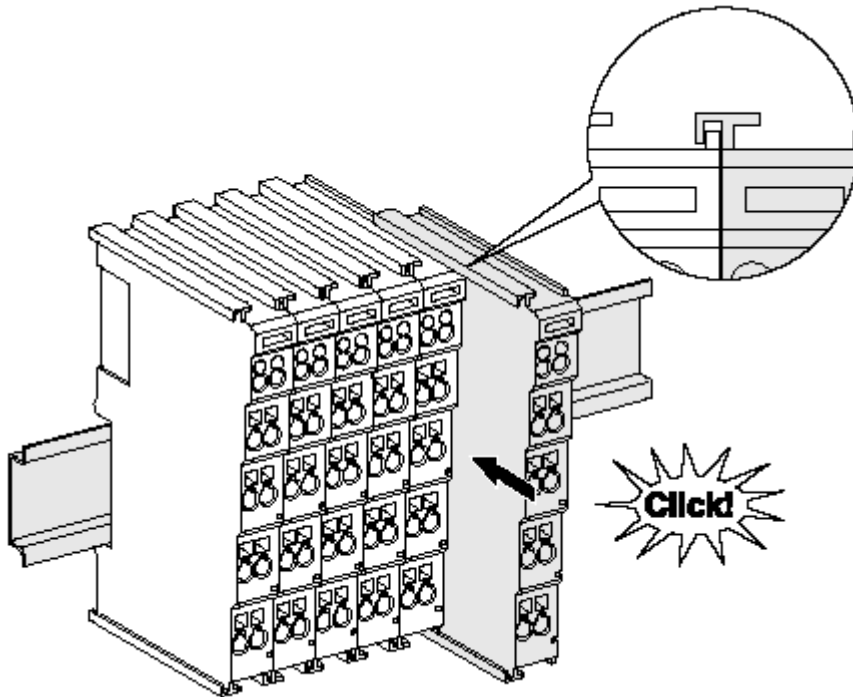

Fig. 3: Attaching on mounting rail

The Bus Coupler and Bus Terminals are attached to commercially available 35 mm mounting rails (DIN rails according to EN 60715) by applying slight pressure:

1. First attach the Fieldbus Coupler to the mounting rail.
2. The Bus Terminals are now attached on the right-hand side of the Fieldbus Coupler. Join the components with tongue and groove and push the terminals against the mounting rail, until the lock clicks onto the mounting rail.

If the Terminals are clipped onto the mounting rail first and then pushed together without tongue and groove, the connection will not be operational! When correctly assembled, no significant gap should be visible between the housings.



Note

Fixing of mounting rails

The locking mechanism of the terminals and couplers extends to the profile of the mounting rail. At the installation, the locking mechanism of the components must not come into conflict with the fixing bolts of the mounting rail. To mount the mounting rails with a height of 7.5 mm under the terminals and couplers, you should use flat mounting connections (e.g. countersunk screws or blind rivets).

Disassembly

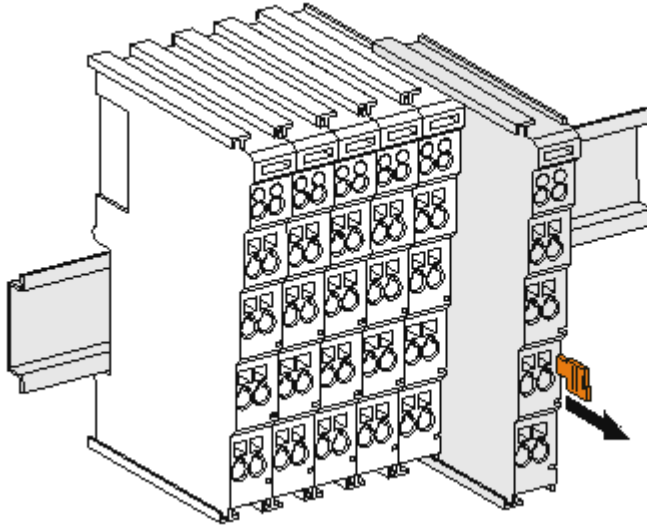

Fig. 4: Disassembling of terminal

Each terminal is secured by a lock on the mounting rail, which must be released for disassembly:

1. Pull the terminal by its orange-colored lugs approximately 1 cm away from the mounting rail. In doing so for this terminal the mounting rail lock is released automatically and you can pull the terminal out of the bus terminal block easily without excessive force.
2. Grasp the released terminal with thumb and index finger simultaneous at the upper and lower grooved housing surfaces and pull the terminal out of the bus terminal block.

Connections within a bus terminal block

The electric connections between the Bus Coupler and the Bus Terminals are automatically realized by joining the components:

- The six spring contacts of the K-Bus/E-Bus deal with the transfer of the data and the supply of the Bus Terminal electronics.
- The power contacts deal with the supply for the field electronics and thus represent a supply rail within the bus terminal block. The power contacts are supplied via terminals on the Bus Coupler (up to 24 V) or for higher voltages via power feed terminals.



Note

Power Contacts

During the design of a bus terminal block, the pin assignment of the individual Bus Terminals must be taken account of, since some types (e.g. analog Bus Terminals or digital 4-channel Bus Terminals) do not or not fully loop through the power contacts. Power Feed Terminals (KL91xx, KL92xx or EL91xx, EL92xx) interrupt the power contacts and thus represent the start of a new supply rail.

PE power contact

The power contact labeled PE can be used as a protective earth. For safety reasons this contact mates first when plugging together, and can ground short-circuit currents of up to 125 A.

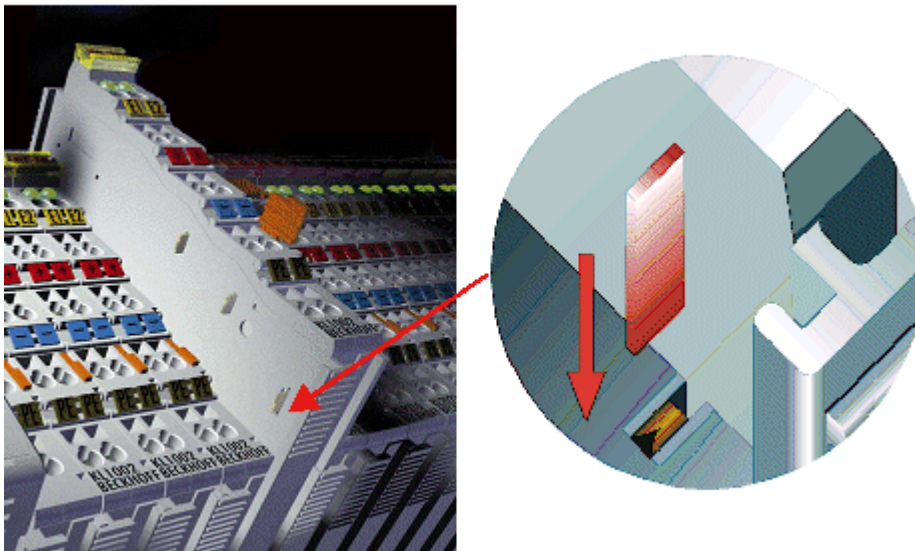

Fig. 5: Power contact on left side



Attention

Possible damage of the device

Note that, for reasons of electromagnetic compatibility, the PE contacts are capacitatively coupled to the mounting rail. This may lead to incorrect results during insulation testing or to damage on the terminal (e.g. disruptive discharge to the PE line during insulation testing of a consumer with a nominal voltage of 230 V). For insulation testing, disconnect the PE supply line at the Bus Coupler or the Power Feed Terminal! In order to decouple further feed points for testing, these Power Feed Terminals can be released and pulled at least 10 mm from the group of terminals.



WARNING

Risk of electric shock!

The PE power contact must not be used for other potentials!

4.2 Connection system



WARNING

Risk of electric shock and damage of device!

Bring the bus terminal system into a safe, powered down state before starting installation, disassembly or wiring of the Bus Terminals!

Overview

The Bus Terminal system offers different connection options for optimum adaptation to the respective application:

- The terminals of KLxxxx and ELxxxx series with standard wiring include electronics and connection level in a single enclosure.
- The terminals of KSxxxx and ESxxxx series feature a pluggable connection level and enable steady wiring while replacing.
- The High Density Terminals (HD Terminals) include electronics and connection level in a single enclosure and have advanced packaging density.

Standard wiring

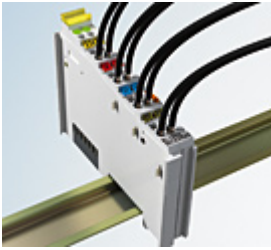

Fig. 6: Standard wiring

The terminals of KLxxxx and ELxxxx series have been tried and tested for years. They feature integrated screwless spring force technology for fast and simple assembly.

Pluggable wiring

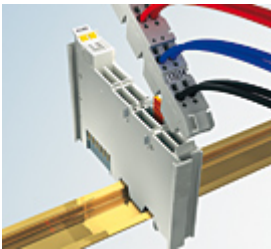

Fig. 7: Pluggable wiring

The terminals of KSxxxx and ESxxxx series feature a pluggable connection level. The assembly and wiring procedure for the KS series is the same as for the KLxxxx and ELxxxx series. The KS/ES series terminals enable the complete wiring to be removed as a plug connector from the top of the housing for servicing. The lower section can be removed from the terminal block by pulling the unlocking tab. Insert the new component and plug in the connector with the wiring. This reduces the installation time and eliminates the risk of wires being mixed up.

The familiar dimensions of the terminal only had to be changed slightly. The new connector adds about 3 mm. The maximum height of the terminal remains unchanged.

A tab for strain relief of the cable simplifies assembly in many applications and prevents tangling of individual connection wires when the connector is removed.

Conductor cross sections between 0.08 mm² and 2.5 mm² can continue to be used with the proven spring force technology.

The overview and nomenclature of the product names for KSxxxx and ESxxxx series has been retained as known from KLxxxx and ELxxxx series.

High Density Terminals (HD Terminals)



Fig. 8: High Density Terminals

The Bus Terminals from these series with 16 connection points are distinguished by a particularly compact design, as the packaging density is twice as large as that of the standard 12 mm Bus Terminals. Massive conductors and conductors with a wire end sleeve can be inserted directly into the spring loaded terminal point without tools.



Note

Wiring HD Terminals

The High Density (HD) Terminals of the KLx8xx and ELx8xx series doesn't support steady wiring.

Ultrasonically "bonded" (ultrasonically welded) conductors



Note

Ultrasonically "bonded" conductors

It is also possible to connect the Standard and High Density Terminals with ultrasonically "bonded" (ultrasonically welded) conductors. In this case, please note the tables concerning the [wire-size width](#) [▶ 14] below!

Wiring

Terminals for standard wiring ELxxxx / KLxxxx and terminals for steady wiring ESxxxx / KSxxxx

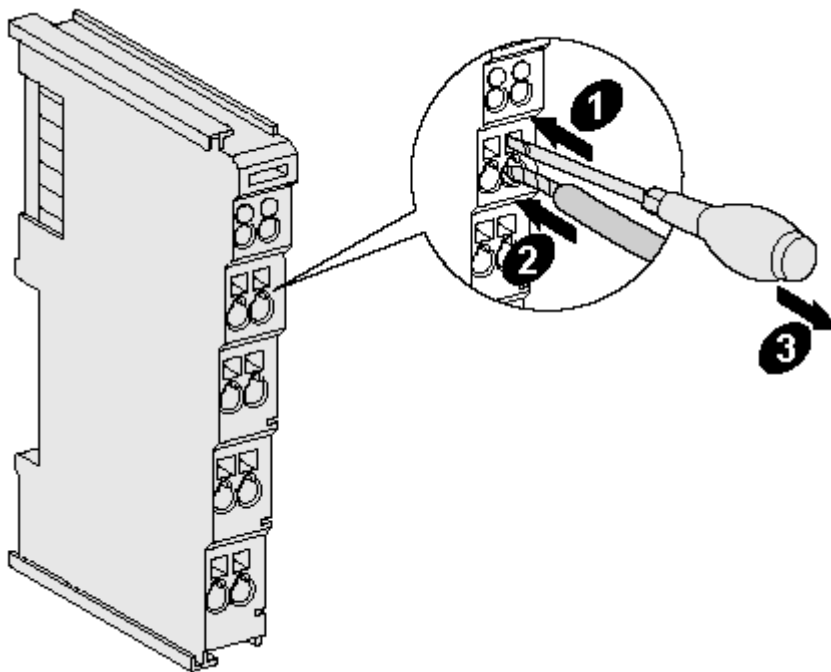

Fig. 9: Mounting a cable on a terminal connection

Up to eight connections enable the connection of solid or finely stranded cables to the Bus Terminals. The terminals are implemented in spring force technology. Connect the cables as follows:

1. Open a spring-loaded terminal by slightly pushing with a screwdriver or a rod into the square opening above the terminal.
2. The wire can now be inserted into the round terminal opening without any force.
3. The terminal closes automatically when the pressure is released, holding the wire securely and permanently.

Terminal housing	ELxxxx, KLxxxx	ESxxxx, KSxxxx
Wire size width	0.08 ... 2,5 mm ²	0.08 ... 2.5 mm ²
Wire stripping length	8 ... 9 mm	9 ... 10 mm

High Density Terminals ELx8xx, KLx8xx (HD)

The conductors of the HD Terminals are connected without tools for single-wire conductors using the direct plug-in technique, i.e. after stripping the wire is simply plugged into the contact point. The cables are released, as usual, using the contact release with the aid of a screwdriver. See the following table for the suitable wire size width.

Terminal housing	High Density Housing
Wire size width (conductors with a wire end sleeve)	0.14... 0.75 mm ²
Wire size width (single core wires)	0.08 ... 1.5 mm ²
Wire size width (fine-wire conductors)	0.25 ... 1.5 mm ²
Wire size width (ultrasonically "bonded" conductors)	only 1.5 mm ² (see notice [► 14]!)
Wire stripping length	8 ... 9 mm

Shielding

 Note	<p>Shielding Analog sensors and actors should always be connected with shielded, twisted paired wires.</p>
--	--

4.3 ATEX - Special conditions

 WARNING	<p>Observe the special conditions for the intended use of Beckhoff fieldbus components in potentially explosive areas (directive 94/9/EU)!</p> <p>✓ Conditions</p> <p>a) The certified components are to be installed in a suitable housing that guarantees a protection class of at least IP54 in accordance with EN 60529! The environmental conditions during use are thereby to be taken into account!</p> <p>b) If the temperatures during rated operation are higher than 70°C at the feed-in points of cables, lines or pipes, or higher than 80°C at the wire branching points, then cables must be selected whose temperature data correspond to the actual measured temperature values!</p> <p>c) Observe the permissible ambient temperature range of 0 - 55°C for the use of Beckhoff fieldbus components in potentially explosive areas!</p> <p>d) Measures must be taken to protect against the rated operating voltage being exceeded by more than 40% due to short-term interference voltages!</p> <p>e) The individual terminals may only be unplugged or removed from the Bus Terminal system if the supply voltage has been switched off or if a non-explosive atmosphere is ensured!</p> <p>f) The connections of the certified components may only be connected or disconnected if the supply voltage has been switched off or if a non-explosive atmosphere is ensured!</p> <p>g) The fuses of the KL92xx/EL92xx power feed terminals may only be exchanged if the supply voltage has been switched off or if a non-explosive atmosphere is ensured!</p> <p>h) Address selectors and ID switches may only be adjusted if the supply voltage has been switched off or if a non-explosive atmosphere is ensured!</p>
---	---

Standards

The fundamental health and safety requirements are fulfilled by compliance with the following standards:

- EN 60079-0: 2006
- EN 60079-15: 2005

Marking

The Beckhoff fieldbus components certified for potentially explosive areas bear one of the following markings:



II 3 G Ex nA II T4 KEMA 10ATEX0075 X Ta: 0 - 55°C

or



II 3 G Ex nA nC IIC T4 KEMA 10ATEX0075 X Ta: 0 - 55°C

4.4 ATEX Documentation



Note

Notes about operation of the Beckhoff terminal systems in potentially explosive areas (ATEX)

Pay also attention to the continuative documentation Notes about operation of the Beckhoff terminal systems in potentially explosive areas (ATEX) that is available in the download area of the Beckhoff homepage <http://www.beckhoff.com>!

4.5 Connection and LED displays

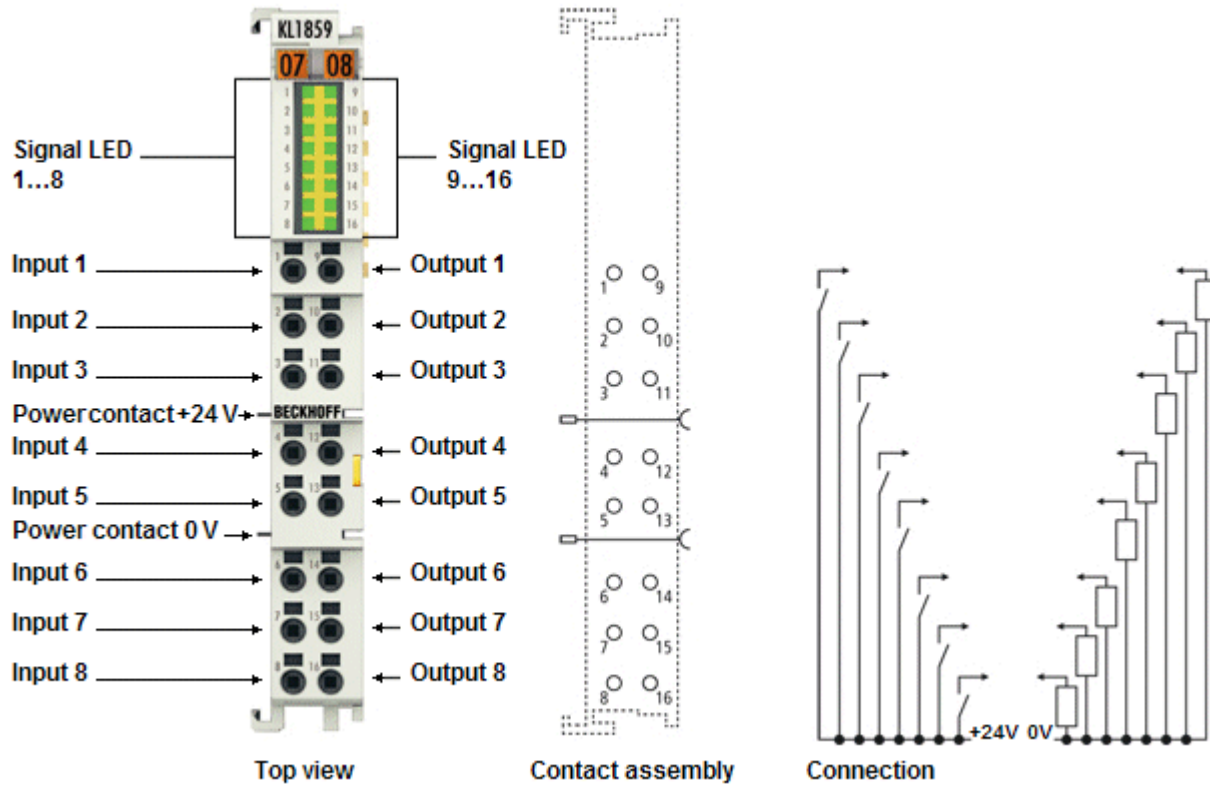

Fig. 10: KL1859 - terminal points and LEDs

Terminal point		Description
Name	No.	
Input 1	1	Input 1
Input 2	2	Input 2
Input 3	3	Input 3
Input 4	4	Input 4
Input 5	5	Input 5
Input 6	6	Input 6
Input 7	7	Input 7
Input 8	8	Input 8
Output 1	9	Output 1
Output 2	10	Output 2
Output 3	11	Output 3
Output 4	12	Output 4
Output 5	13	Output 5
Output 6	14	Output 6
Output 7	15	Output 7
Output 8	16	Output 8

LED indicators

LED	Color	Meaning	
INPUT 1- 8	green	off	signal "0" voltage (-3 V ... 5 V)
		on	signal "1" voltage (15 V ... 30 V)
OUTPUT 1- 8	green	off	no output voltage
		on	+24 V _{DC} output voltage

5 Appendix

5.1 Support and Service

Beckhoff and their partners around the world offer comprehensive support and service, making available fast and competent assistance with all questions related to Beckhoff products and system solutions.

Beckhoff's branch offices and representatives

Please contact your Beckhoff branch office or representative for local support and service on Beckhoff products!

The addresses of Beckhoff's branch offices and representatives round the world can be found on her internet pages:

<http://www.beckhoff.com>

You will also find further documentation for Beckhoff components there.

Beckhoff Headquarters

Beckhoff Automation GmbH & Co. KG

Huelshorstweg 20
33415 Verl
Germany

Phone:	+49(0)5246/963-0
Fax:	+49(0)5246/963-198
e-mail:	info@beckhoff.com

Beckhoff Support

Support offers you comprehensive technical assistance, helping you not only with the application of individual Beckhoff products, but also with other, wide-ranging services:

- support
- design, programming and commissioning of complex automation systems
- and extensive training program for Beckhoff system components

Hotline:	+49(0)5246/963-157
Fax:	+49(0)5246/963-9157
e-mail:	support@beckhoff.com

Beckhoff Service

The Beckhoff Service Center supports you in all matters of after-sales service:

- on-site service
- repair service
- spare parts service
- hotline service

Hotline:	+49(0)5246/963-460
Fax:	+49(0)5246/963-479
e-mail:	service@beckhoff.com

List of illustrations

Fig. 1	KL1859	7
Fig. 2	KL1859 within TwinCAT 2.11	9
Fig. 3	Attaching on mounting rail	10
Fig. 4	Disassembling of terminal.....	11
Fig. 5	Power contact on left side.....	12
Fig. 6	Standard wiring.....	13
Fig. 7	Pluggable wiring	13
Fig. 8	High Density Terminals.....	13
Fig. 9	Mounting a cable on a terminal connection	14
Fig. 10	KL1859 - terminal points and LEDs	17