

Standard enclosure
Series CT (Polycarbonate)

Designation CT-681 Polycarbonate **Article number 268000000**

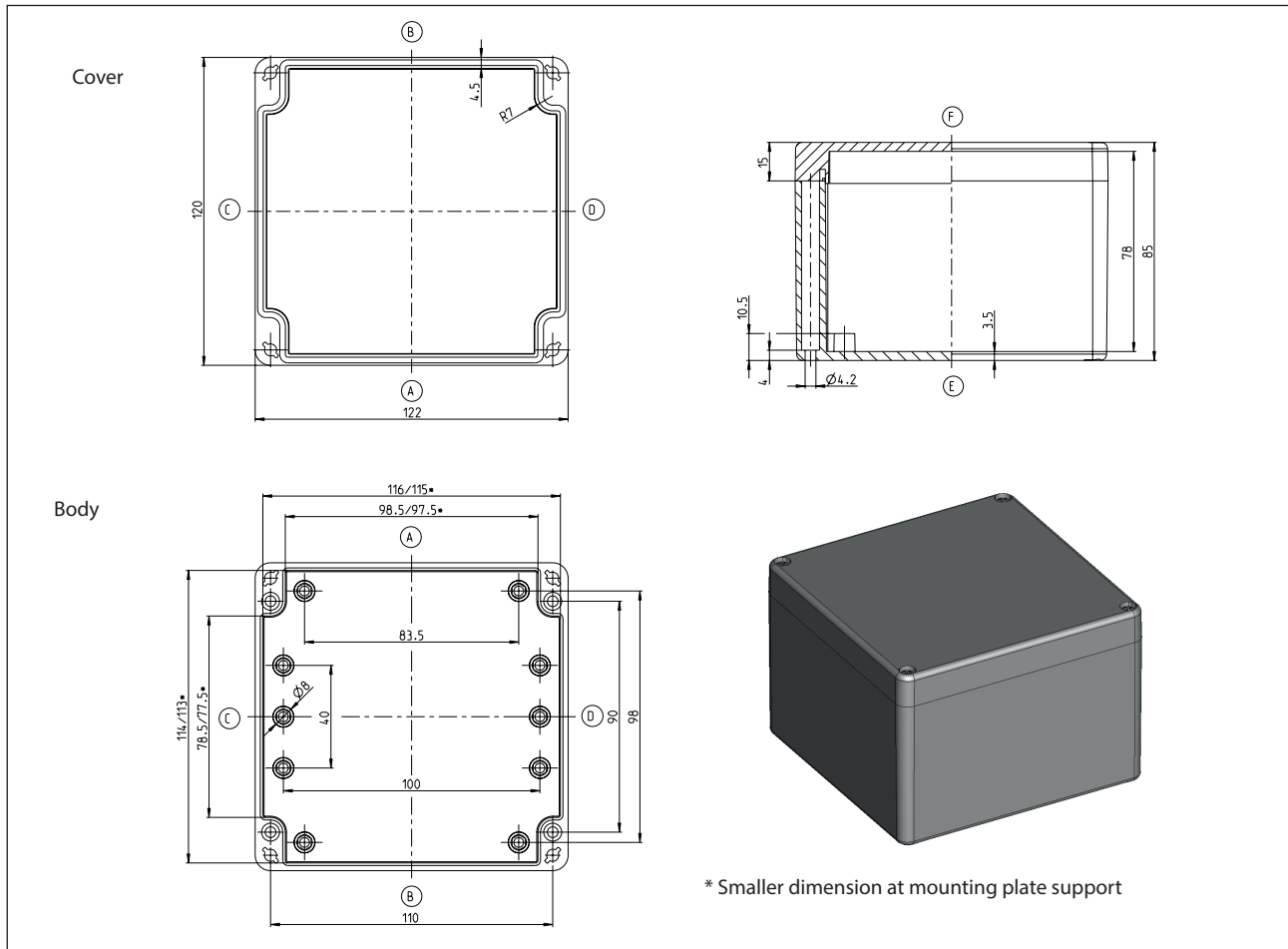

Standard version

Scope of supply:

Base of enclosure
Enclosure cover
Quick-release screw (cross recessed head) enclosed loosely
Colour RAL 7035 (light grey)
Cover gasket PUR (polyurethane)
Internal mounting plugs for selftapping screws (are included)
Individually packaged in foil

Maximum possible number of thread (figures for identical diameter, not mixed!)

ISO M	M12	M16	M20	M25	M32	M40	M50	M63
Page A/B	15	6	6	3	2	1	1	0
Page C/D	10	3	3	2	1	0	0	0

Property chart CT-681

Specification	Value	According to the standard	Remark
General data:			
Weight	295 g		
External dimensions	122 x 120 x 85		
Protection classes			
IP code	IP 66	EN 60529	
IK code	IK 07	IEC 62262	
Material			
Enclosure	Polycarbonat (PC)		light grey
Quick-release fastener	1.4303		DIN EN 10088-3
Screws	A2 - 70		DIN EN ISO 3506-1
Seal	PUR (Polyurethan)		Colour: dark grey, 2-component polyurethane foam seal
Toxic behaviour	halogen-free		
Thermal properties:			
Fire behaviour			
Flammability	V-2	UL 94	Contentwise alike with EC60695-11-10 and IEC60695-11-20
glow wire test	960°C ; 2 mm	IEC 60695-2-12	
glow wire test	900°C ; 1mm	IEC 60695-2-12	
glow wire test			
Temperature range			
Enclosure without a seal	-40 °C bis +120 °C		
Seal PUR	-40 °C bis +100 °C		
Temperature index Enclosure material			
RTI (tensile strength)	80 °C	UL 746 B	
RTI (impact strength)	80 °C	UL 746 B	
RTI (dielectric strength)	80 °C	UL 746 B	
Ambient temperatur according to DIN EN 62208			
Indoor application	-5 °C bis +40 °C	DIN EN 62208	On the average over 24h +35°C
Relative humidity according to DIN EN 62208			
Indoor application	max. 50% bei -40 °C	DIN EN 62208	with low temperatures also higher (for ex. 90% at +20°C)
Storage temperature	-20 °C bis +60 °C		
Enclosure-specific thermal conductivity value	3,93 K/W		taking account of effective dissipation loss

Property chart CT-681

Specification	Value	According to the standard	Remark
Mechanical properties:			
Torques			
quick – release screw	1/4 Rotation		
Attachment of accessories	1,0 Nm		for ex. mounting plates, mounting rails
Other mounting	1,0 Nm		Screw channel, External mounting brackets
Maximum installation weight	0,9 kg		
Electrical characteristics:			
Protection class	II	EN 61140 / VDE 0140-1	 Protection by double or reinforced insulation
Rated voltage	max. 1000V		Maximum length of the extension arm
Surface resistivity	10 ¹⁵ Ohm	IEC 60093	
Dielectric strength	33 kv/mm	IEC 60243-1	
More details:			
General tolerance	mH	ISO 2768	
Product standard	Yes	DIN EN 62208	Empty enclosures for low-voltage switchgear assemblies
Approvals			
c UL us	Yes	UL508A / C22,2	Typ 1, 4, 4x indoor
Compliances			
RoHs	Yes	Directive 2011/65/EU	
CE label	Yes	EC-No 765/2008	
Low-Voltage-Directive No.:	2014/35/EU		

Other versions / Accessories

The following information is not a standard. Approvals, compliances and protection classes of these versions upon request.

Other version CT-681	
Description of the modification compared with the standard version	Article number
PC, with screw fastener	2680001000

Possible Accessories / as individual parts or as assembly set	
Description of the modification compared with the standard version	Article number
Mounting plate	9512014000
Mounting rail TS 15	-
Mounting rail TS 32	9821001000
Mounting rail TS 35	9822002000
Earthing rail (secured on central bosses C/D)	9810003000
External mounting brackets	9802002000
External articulated hinges (mechanical machining of the enclosure required)	9802025000
Internal articulated hinges (flexible)	9801076000
Mounting bushes with 4 screws M3 x 8	9800025000

Optional seals			
Specification	Value	According to the standard	Remark
Thermal properties:			
CR seal	-30 °C bis +80 °C		IP65
Silicone foam seal	-60 °C bis +130 °C		on request
Silicone complete seal	-60 °C bis +200 °C		on request
EPDM seal	-35 °C bis +100 °C		on request
HF seal	-55 °C bis +125 °C		on request