

Safety switch

Series SLK – with separate actuator

Description **SLK-F-NC-22-R1-A0-L0-0**

Article number **6018169055**

Position monitoring of guard locking

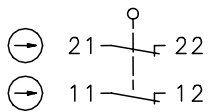

Termination electromagnet with contact position E1, E2 without current

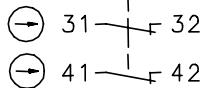
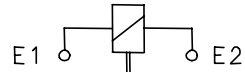

E1, E2 with current

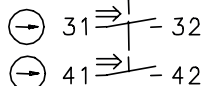
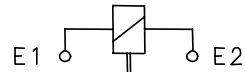

Operating diagram

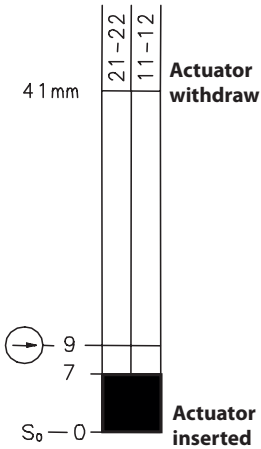

The actuator is not included in the scope of delivery. It can only be purchased in conjunction with the safety switch.

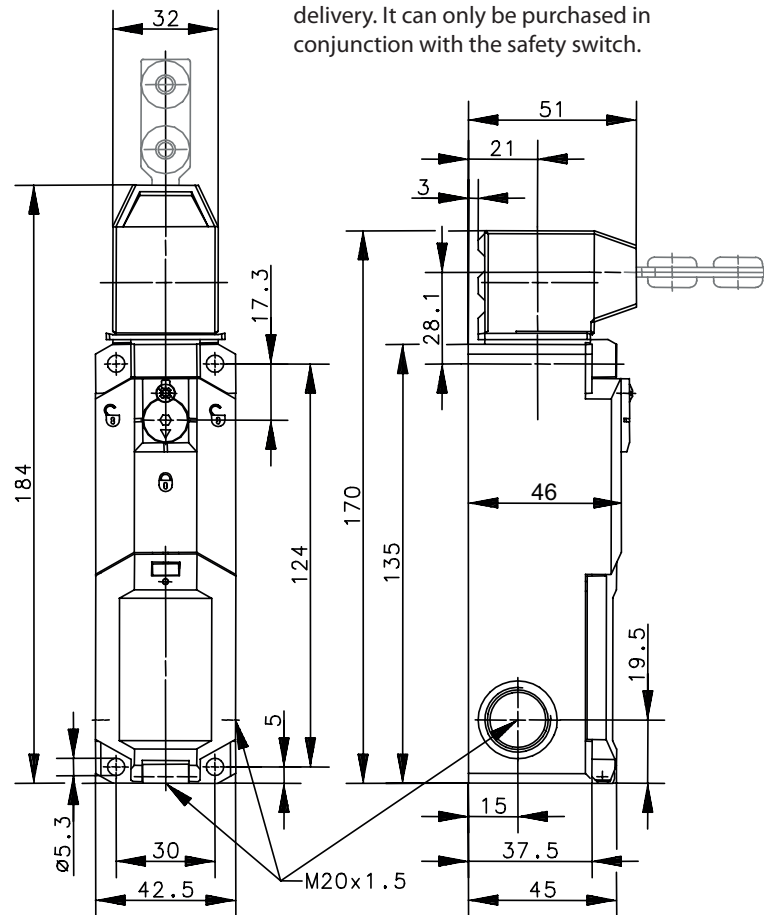

Electrical data	
Protection class	II, totally insulated
Contact elements	
Rated insulation voltage	U_i 250 V
Rated impulse withstand voltage	U_{imp} 2,5 kV
Conv. thermal current	I_{the} 5 A
Utilization category	AC-15, U_e / I_e 230 V / 2,5 A
Direct opening action	⊙ according to IEC/EN 60947-5-1, Annex K
Short-circuit protective device	4 A gG
Electro magnets	
Duty cycle	100 % ED (at E1; E2)
Temperature class	F (155 °C)
Inrush power consumption	65 VA (0,1 s)
Permanent power consumption	8 VA
Switch operations permanent	600 / h
Operating voltage	110 / 230 V AC

Mechanical data	
Enclosure	Thermoplastic, glass fibre reinforced (UL 94-V0)
Cover	Thermoplastic, glass fibre reinforced (UL 94-V0)
Actuating head	Thermoplastic, glass fibre reinforced / Zn-GD
Actuator	Separate actuator (Steel / PA)
Minimum actuating radius	R_{min} see separate actuators data sheet
Velocity for actuating	V_{max} 0,5 m/s
Extraction force	≥ 27 N
Interlocking principle	Spring force
Unlocking	a) magnetic force b) auxiliary release from the front
Hold on force	F_{Zh} ≤ 1500 N acc. to GS-ET-19
Ambient air temperature	-25 °C ... +70 °C
Contact type	4 NC
Switching principle	4 slow make and break contact elements
Mechanical life	1 x 10 ⁶ switching cycles (at max. 600 switch operations / h)
Assembly	4 x M5
Connection	Spring-clamp connection
Conductor cross-sections	0,5 ... 1,5 mm ² flexible
Cable entrance	3 x M20 x 1,5
Weight	≈ 0,34 kg
Installation position	operator definable
Protection type	IP67 acc. to IEC/EN 60529

ID for safety engineering	
B10d	2 x 10 ⁶ cycles

Anfahrmöglichkeiten	
4 different actuating directions achievable by rotating the actuating head. Changing between horizontal and vertical actuating direction by setting the actuating head in the requested direction.	

Standards	
	VDE 0660 T100, DIN EN 60947-1, IEC 60947-1
	VDE 0660 T200, DIN EN 60947-5-1, IEC 60947-5-1
	GS-ET-19
	DIN EN ISO 13849-1

EU Conformity	
	acc. to directive 2006/42/EC (Safety-of-Machinery-Directive)

Approvals	
	DGUV
	cCSA _{US} B300 (same polarity)
	CCC

Notes	
<p>The degree of protection (IP code) specified applies solely to a property closed cover and the use of an equivalent cable gland with adequate cable.</p> <p>The switch may not be used as a mechanical stop.</p> <p>When power is removed from the electromagnet (solenoid) the safety guard will be in locked position.</p> <p>To operate the manual release loosen the screw and turn the hexagonal nut 90°.</p>	