

Coded Magnet Switch Series MAK-42

Description **MAK-4236-9 TÜV**

Article number **6490642303**

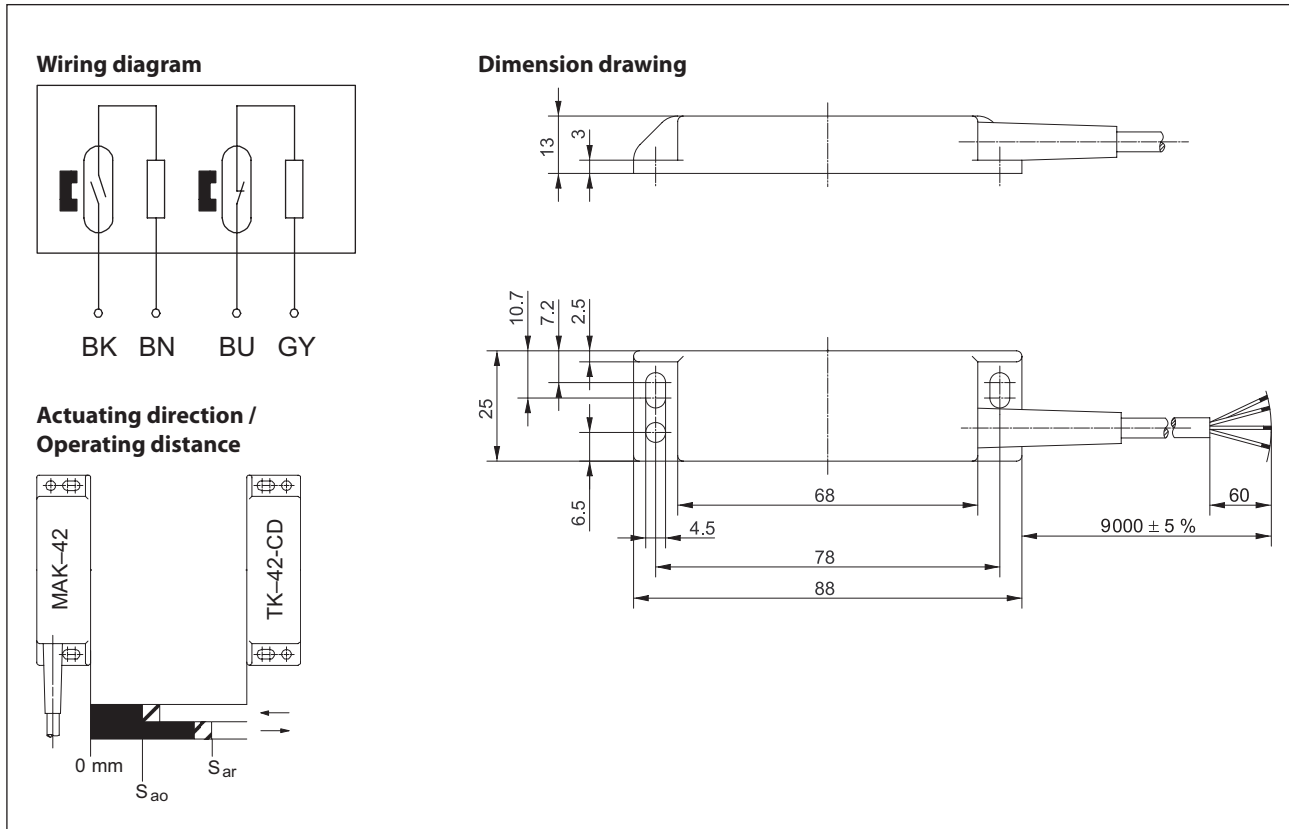

Technical data

Switching function	N.O., N.C. combined	
Reference magnet	TK-42-CD (6402042310)	
Assured operating distance - ON	S_a	≥ 5 mm
Assured operating distance - OFF	S_{ar}	≤ 14 mm
Repeat accuracy	R	$\pm 0,1$ mm, under same geometrical conditions at the same temperature
Utilization category	DC-12	
Frequency of operating cycles	f	1 Hz

Electrical data

Max. voltage	30 V DC
Max. switching current	0,08 A
Max. switching capacity	0,25 W
Internal series resistors	27 Ω , per channel
Protection class acc. to EN IEC 61558	III (safety extra-low voltage)
Note	Combinations of switching voltage and switching current must not exceed the maximum switching capacity.

Mechanical data	
Enclosure	PA6, black (encapsulated reed contact)
Tightening torque of fastening screws	1,25 Nm ± 0,25 Nm
Temperature range	- 5 °C ... + 70 °C (cable not fixed mounted) - 25 °C ... + 70 °C (cable fixed mounted)
Mechanical life	3 x 10 ⁸ operating cycles
Vibration	30 G (50 - 2000 Hz)
Shock	50 G (11 ms, ½ Sinewave)
Protection type	IP 67 acc. to EN 60529
Degree of pollution	3 acc. to 60947-1
Termination type	Cable 4 x 0,25 mm ² ; PVC -outer jacket black
Assembly position	optional (assembly on ferromagnetic material means reduction of switch distance)

ID for safety engineering	
B10d	20 x 10 ⁶ cycles (20 % load) 0,4 x 10 ⁶ cycles (nominal load)
Mission time	20 years

Standards	
	DIN EN ISO 13849-1
	EN 60947-5-3
Note	The EN 60947-5-3 standard is only fulfilled by a complete system that consists of a coded magnetic switch with related actuator and suitable safety controller.

EU Conformity	
	acc. to directive 2006/42/EC (Safety-of-Machinery-Directive)

Approvals	
	TÜV Nord

Notes	
	Contact protection must be provided for inductive and capacitive loads.