

ASi Safety Relay Output Module with Diagnostic node, 1 EDM, 1 x 2 channel Safe Input

Safety + standard I/O in one module

Safety relay output with galvanically isolated contact sets, approved up to 230 V

Additionally 1 EDM input, 1 x 2 channel safe input

Applications up to category 4/PLe/SIL 3

Protection category IP20



(Figure similar)



Article no. BWU2236 ASi Safety Relay Output Module with Diagnostic node, 1 EDM, 1 x 2 channel Safe Input

The stainless steel ASi Safety Monitor controls the safety relays of the ASi Safety Relay Output Module by using a safety ASi single address. To set the safety ASi address, the dip-switch has to be in the ON/PRG position. Addressing can then be accomplished by using an ASi addressing device, for example. Several ASi Safety Relay Output modules can have the same safety address and can be controlled via this same safety address on a ASi circuit. All ASi Safety Relay Output Modules with the same safety address are controlled simultaneously.

In addition to the safety single address the module also supports an AB-address e.g. used to transmit the states of the standard inputs and a safety input address.

BWU2236: 3 ASi modules in one housing!

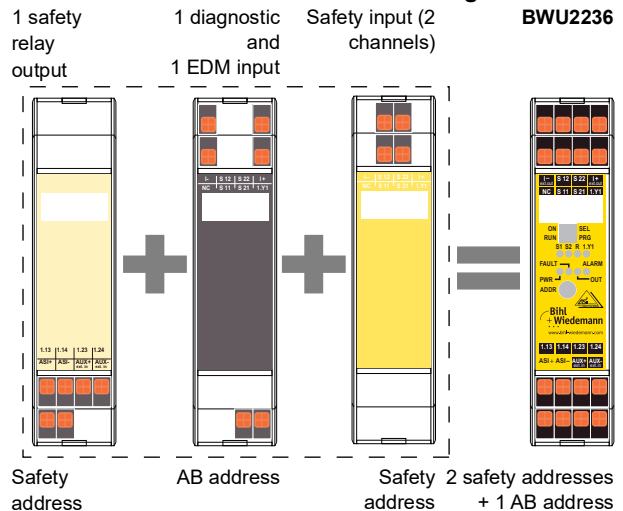

Article no.	BWU2236
Connection	
Connection	4 x COMBICON
Length of connector cable	unlimited ⁽¹⁾
ASi	
Profile	diagnostic AB node: S-7.A.E (ID1=5 default), value adjustable safety input S-7.B.0 (ID1=F fixed)
Address	2 single addresses + 1 AB address
Required master profile	≥ M3
As of ASi specification	2.1
Operating voltage	30 V _{DC} (18 ... 31,6 V)
Max. current consumption	< 200 mA

ASi Safety Relay Output Module with Diagnostic node, 1 EDM, 1 x 2 channel Safe Input

Article no.	BWU2236
AUX	
Voltage	24 V _{DC} (± 20%)
Current input out of AUX _{ext. in}	< 30 mA
Input	
Number	1 EDM, diagnostic, 1 x 2 channel safe input (cat. 4 / SIL 3)
Switching current	15 mA (T = 100 µs), continuously 4 mA at 24 V
Power supply	out of AUX
Power supply of attached sensors	30 mA
Max. resistance between S 11 - S12; S 21 - S 22	150 Ω
Current capacity max. I+	max. 30 mA
External device monitoring (EDM)	reference potential over I+, I-
Output	
Number	1 relay output max. contact load: 3 A DC-13 at 24 V or 3 A AC-15 at 230 V
Max. output current	max. 3 A
Max. inrush current	20 A for 20 ms
Number of switching operations	
Usage category (EN 60347-4-1 / EN 60947-5-1)	AC1: 230V/3A (ca. 150 x 10 ³ cycles) AC 15: 230V/3A (ca. 80 x 10 ³ cycles) DC 1: 24V/3A (ca. 500 x 10 ³ cycles) DC 13: 24V/3A/0,1 Hz (ca. 50 x 10 ³ cycles)
Display	
LED S1, S2 (yellow)	state of safety inputs (S 11 - S 12, S 21 - S 22)
LED R (yellow)	release status
LED 1.Y.1 (yellow)	state of EDM input 1.Y1
LED PWR (green)	ASi voltage ON
LED FAULT (red)	ASi Fault
LED OUT (yellow)	for definition see table "device colors"
LED ALARM (red)	PLC indicates alarm
Environment	
Applied standards	EN 61508:2010 EN ISO 13849-1:2015 EN 62061:2005+Cor.:2010+A1:2013+A2:2015 EN 60947-5-1:2004+ Cor.:2005+A1:2009 EN 60529
Can be used in passively safe paths up to SIL3/PLe	no ⁽²⁾
Operating height max.	2000 m
Ambient temperature	-30 °C ... +55 °C ⁽³⁾ , no condensation permitted
Storage temperature	-25 °C ... +85 °C
Pollution Degree	2
Protection category	IP20
Tolerable loading referring to humidity	according to EN 61131-2
Housing	plastic, Din-rail mounting
Voltage of insulation (relay contact for ASi resp. AUX _{ext. in})	≥6 kV
Voltage of insulation ASi to AUX _{ext. in}	≥500 V
Weight	150 g
Dimensions (L / W / H in mm)	22,5 / 99 / 114

(1) loop resistance ≤ 150 Ω

(2) The module is not suitable for use in passively safe paths because an exclusion of errors cannot be assumed for the connection of the two potentials, ASi and AUX.

ASi Safety Relay Output Module with Diagnostic node, 1 EDM, 1 x 2 channel Safe Input

⁽³⁾ temperature range up to -30°C from Ident.No. ≥16368

Wiring rules

Push-in terminals	
General	
Nominal cross section	2.5 mm ²
Conductor cross section	
Conductor cross section solid	0.2 ... 2.5 mm ²
Conductor cross section flexible	0.2 ... 2.5 mm ²
Conductor cross section flexible, with ferrule	without plastic sleeve: 0.2 ... 2.5 mm ²
	with plastic sleeve: 0.25 ... 2.5 mm ²
2 conductors with same cross section, stranded, with TWIN ferrules	without plastic sleeve: 0.5 ... 1.5 mm ²
AWG	24 ... 14
Stripped insulation length	10 mm

UL-specifications (UL508) BWU2236	
External protection	An isolated source with a secondary open circuit voltage of ≤30 V _{DC} with a 3 A maximum over current protection. Over current protection is not required when a Class 2 source is employed.
In general	UL mark does not provide UL certification for any functional safety rating or aspects of the above devices.

Diagnostic node (Programming instructions (Bit values of the inputs/outputs, AB node))

Bit	ASi output	Bit	ASi input
O0	1: Alarm LED on 0: Alarm LED off	I0	Diagnostic (for definition see table "device colors")
O1	Parameter P1=1	I1	Parameter P1=0
	not used		
O2	not used	I2	
O3	inexistent	I3	Parameter P2=0
			Parameter P2=1
			1: feedback for user: safety release on 0: feedback for user: safety release off
			1.Y1

Peripheral fault indicates unavailable 24 V ext.

Diagnostic (device colors)

Value	Color	Description	State change	LED "Out"
0	green	output on		on
1	green flashing	–		–
2	yellow	restart inhibit	auxiliary signal 2	1 Hz
3	yellow flashing	–		–
4	red	output off		off
5	red flashing	waiting for "reset of error condition"	auxiliary signal 1	8 Hz
6	gray	internal error, such as "fatal error"	only via "Power On" on device	all LEDs flashing
7	green/yellow	output released, but not switched on	switching-on by setting of O1	off

ASi Safety Relay Output Module with Diagnostic node, 1 EDM, 1 x 2 channel Safe Input

Programming instructions Diagnostic node (bit values of the ASi parameter)

Bit P1	
P1=1	safety output controlled by safety release only
P1=0	safety output controlled by output O1 in addition to safety release
Bit P2	
P2=1	input 1.Y1 at ASi bit I 3
P2=0	feedback for user: release on
Bits P0, P3:	
not used	

Release		ASi Safety Relay Output Module, safety release from the ASi safety monitor...	
		... not received	... received
ASi parameter (AB node) changes the function of output bit O1	ASi Parameter P1=1 (default) O1=0	safety output contact set open	safety output contact set closed
	ASi Parameter P1=1 O1=1	safety output contact set open	safety output contact set closed
	ASi Parameter P1=0 O1=0	safety output contact set open	safety output contact set open
	ASi Parameter P1=0 O1=1	safety output contact set open	safety output contact set closed

Safety input (Programming instructions (bit values of the safety input address))

Bit	ASi output	Bit	ASi input
	outputs not used	I0, I1	safety input S 1
		I2, I3	safety input S 2





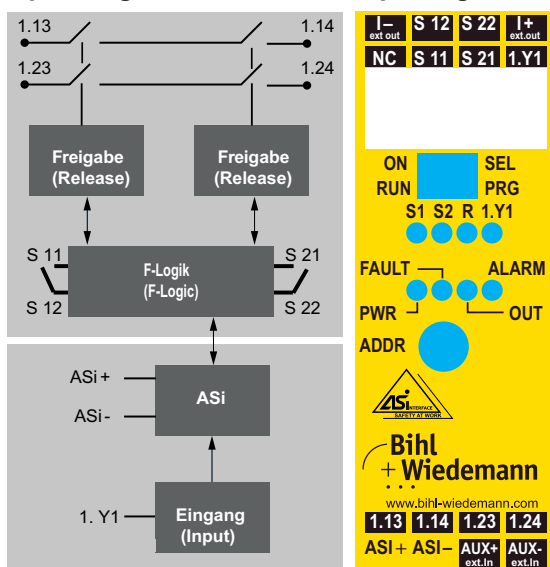















Peripheral fault indicates cross-connection between the safety inputs.

Operating elements and clamp assignment



Clamps	Description
S11, S12, S21, S22	safety input clamps
1.13, 1.14	safety output contact set 1
1.23, 1.24	safety output contact set 2
I _{-ext.out}	reference potential for EDM-/start input (1.Y1)
I _{+ext.out}	
1.Y1	EDM / start input
ASi +, ASi -	ASi network connection
AUX + _{ext.in}	voltage supply for safety input (24V _{DC} ext.)
AUX - _{ext.in}	

ASi Safety Relay Output Module with Diagnostic node, 1 EDM, 1 x 2 channel Safe Input

LEDs	State	Signal / Description
PWR (green)		no operating voltage
	 1 Hz	operating voltage present, safety-related ASi address and/or ASi AB address is „0“ or no 24V ext. in (auxiliary power)
		operating voltage present
FAULT (red)		ASi communication OK
	 1 Hz	no 24V ext. in (auxiliary power)
		no data exchange with AB node and/or safety-related ASi address
OUT (yellow)		output relays contacts open
	 1 Hz	restart inhibit, waiting for the start signal, the output relays switch-on after the start signal
	 8 Hz	device is in unlockable error state. Waiting for "reset of error condition signal". After receiving this signal the device follows up with normal operation.
		output relays contacts closed
ALARM (red)		ASi output bit 0 is <i>not</i> set
		ASi output bit 0 is set
S1, S2, 1.Y1 (yellow)		the corresponding input is <i>not</i> connected
		the corresponding input is connected
S1, S2 (yellow)	 2 Hz	cross-connection at the safety inputs
R (yellow)		release not issued
		release issued
S1, S2, R, 1.Y1 (yellow)	 (running light)	switch is adjust to ON/PRG position
 LED on  LED flashing  LED off		

	In case all LEDs are blinking simultaneously in fast rythm a fatal error has been detected. This message is reset by a short-run disconnection of the power supply (Power ON Reset).
---	--

Accessories:

- Safe contact expander, 1 or 2 independent channels (art. no. BWU2548 / BWU2539)
- ASi-5/ASi-3 Address Programming Device (art. no. BW4708)