

# ASi-3 Gateways, PROFIsafe via PROFIBUS or PROFINET

## ASi-3 Gateways, PROFIsafe via PROFINET or PROFIBUS

### PROFIsafe and Safe Link in one device

- up to 450 devices

### 2 / 1 Master, PROFINET / PROFIBUS Slave

- ASi Safety input slaves report via PROFIsafe
- ASi Safety output slaves switch via PROFIsafe

### Up to 64 release circuits

- up to 6 safe output circuits CAT4, SIL 3 on the Monitor safe relays or electronic safe outputs

### Safe ASi outputs are supported

- up to 32 independent ASi outputs  
Multiple safe ASi outputs possible via a single ASi address

### 1 Safety Monitor for 2 ASi networks

- Operation using a single Monitor configuration!  
Monitor processes safety slaves on two ASi networks  
Coupling between the two networks superfluous

### Safe speed and standstill monitoring

### Applications up to category 4/PLe/SIL 3

### Chip card for storage of configuration data





(Figure similar)



Figure	Type	Inputs Safety, SIL 3, cat. 4	Inputs safety, expandable to	Outputs Safety, SIL 3, cat. 4	Safety outputs, independent according to SIL 3, expandable to	Safety communication	Number of ASi networks, number of ASi Master <sup>(1)</sup>	1 power supply, 1 gateway for 2 ASi networks, inexpensive power supplies <sup>(2)</sup>	Diagnostic and configuration interface <sup>(3)</sup>	Article No.
	PROFIsafe, PROFIBUS	3 x 2 channels	max. 31 x 2-kanalig,	6 release circuits; 6 x electronic safe outputs	max. 31	PROFIsafe (F-CPU) + ASIMON program	1 ASi network, 1 ASi Masters	yes, max. 4A/ ASi network	Ethernet diagnostics	<b>BWU2819</b>
	PROFIsafe, PROFIBUS	—	max. 62 x 2 channels	4 release circuits; 2 x relay, 2 x electronic safe outputs	max. 16	PROFIsafe (F-CPU) + ASIMON program	2 ASi networks, 2 ASi Masters	yes, max. 4A/ ASi network	Ethernet diagnostics	<b>BWU2615</b>
	PROFIsafe, PROFIBUS	—	max. 62 x 2 channels	4 release circuits; 2 x relay, 2 x electronic safe outputs	max. 16	PROFIsafe (F-CPU) + ASIMON program	2 ASi networks, 1 ASi Master	yes, max. 4A/ ASi network	Ethernet diagnostics	<b>BWU2598</b>
	PROFIsafe, PROFIBUS	—	max. 31 x 2 channels	—	max. 16	PROFIsafe (F-CPU)	1 ASi network, 1 ASi Masters	yes, max. 4A/ ASi network	RS 232	<b>BWU2479</b>

# ASi-3 Gateways, PROFIsafe via PROFIBUS or PROFINET

Figure	Type	Inputs Safety, SIL 3, cat. 4	Inputs safety, expandable to	Outputs Safety, SIL 3, cat. 4	Safety outputs, independent according to SIL 3, expandable to	Safety communication	Number of ASi networks, number of ASi Master <sup>(1)</sup>	1 power supply, 1 gateway for 2 ASi networks, inexpensive power supplies <sup>(2)</sup>	Diagnostic and configuration interface <sup>(3)</sup>	Article No.
	PROFIsafe, PROFINET	3 x 2 channels	max. 62 x 2 channels, 1922 in max. configuration	6 release circuits; 6 x electronic safe outputs	max. 64, 1984 in max. configuration	PROFIsafe (F-CPU) + ASIMON program + Safe Link	2 ASi networks, 2 ASi Masters	yes, max. 4A/ ASi network	Ethernet fieldbus; Ethernet diagnostics	BWU3367
	PROFIsafe, PROFINET	3 x 2 channels	max. 31 x 2 channels	6 release circuits; 6 x electronic safe outputs	max. 31	PROFIsafe (F-CPU) + ASIMON program	1 ASi network, 1 ASi Masters	yes, max. 4A/ ASi network	Ethernet fieldbus; Ethernet diagnostics	BWU2794
	PROFIsafe, PROFINET	–	max. 62 x 2 channels	4 release circuits; 2 x relay, 2 x electronic safe outputs	max. 16	PROFIsafe (F-CPU) + ASIMON program	2 ASi networks, 2 ASi Masters	yes, max. 4A/ ASi network	RS 232 + Ethernet fieldbus	BWU2647
	PROFIsafe, PROFINET	–	max. 62 x 2 channels	–	max. 16	PROFIsafe (F-CPU) + ASIMON program	2 ASi networks, 2 ASi Masters	yes, max. 4A/ ASi network	Ethernet fieldbus; Ethernet diagnostics	BWU2805

(1) **Number of ASi networks, number of ASi Master**

"Single Master": 1 ASi network, 1 ASi Master.

"Double Master": 2 ASi networks, 2 ASi Masters.

"Optional ASi Safety coupling circuit": 2 ASi networks, 1 ASi Master.

(2) **1 power supply, 1 gateway for 2 ASi networks, inexpensive power supplies**

"yes, max. 4A/ASi network": Cost-effective power for 2 ASi networks with 1 power supply.

(3) **Diagnostic and configuration interface**

"Ethernet fieldbus + Ethernet diagnostic": Access to ASi master and safety monitor via Bihl+Wiedemann proprietary software over Ethernet diagnostics interface or Ethernet fieldbus interface.

"Ethernet diagnostic": Access to ASi master and safety monitor via Bihl+Wiedemann proprietary software over Ethernet diagnostics interface.

"Ethernet fieldbus + RS 232": Access to ASi master and safety monitor via Bihl+Wiedemann proprietary software over Ethernet fieldbus interface or RS 232 interface and adapter cable.

"RS 232": Access to ASi master and safety monitor via Bihl+Wiedemann proprietary software over RS 232 interface and adapter cable.

The latest version of the device description file of the gateway with integrated safety monitor is available in the "Downloads" section of the respective device.

Article no.	BWU2479	BWU2598	BWU2615	BWU2819	BWU2647	BWU2805	BWU2794 / BWU3367
<b>Interface</b>							
<b>Fieldbus interface</b>	<b>PROFIBUS (RS 485)</b>				<b>PROFINET (RJ-45)</b>		
	acc. to IEC 61158 / IEC 61784-1				<ul style="list-style-type: none"> <li>2 x RJ-45, integrated 2-Port-Switch IRT capability                             <ul style="list-style-type: none"> <li>Conformance Class B</li> <li>integrated switch complies with Conformance Class C (IRT capability)</li> </ul> </li> </ul>		
Baud rates	9,6 Kbaud ... 12000 Kbaud, automatic recognition				10/100 Mbaud		
Function	DP function: <ul style="list-style-type: none"> <li>imaging of the ASi Slaves as I/O of the PROFIBUS</li> <li>complete diagnosis and configuration via the DP Master</li> </ul>				<ul style="list-style-type: none"> <li>PROFINET IO Device</li> <li>Media Redundancy Protocol (MRP)                             <ul style="list-style-type: none"> <li>Shared Device</li> </ul> </li> </ul>		
Card slot	chip card for storage of configuration data						
<b>ASi</b>							
ASi specification	3.0						
Cycle time	150 µs * (number of slaves + 2)						
Operating voltage	30 V <sub>DC</sub> (20 ... 31,6 V) (PELV voltage)						
ASi Power24V capability <sup>(1)</sup>	no			yes			

# ASi-3 Gateways, PROFIsafe via PROFIBUS or PROFINET

Article no.	BWU2479	BWU2598	BWU2615	BWU2819	BWU2647	BWU2805	BWU2794 / BWU3367
<b>AUX</b>							
Operating voltage	–	24 V <sub>DC</sub> (19,2 ... 28,8 V)				–	24 V <sub>DC</sub> (19,2 ... 28,8 V)
Max current consumption	–	1 A	7,2 A	1 A	–	7,2 A	
<b>Display</b>							
LCD	indication of slave addresses and error messages in plain text						
LED PROFINET (green / red)	–				green: PROFINET communication active red: no PROFINET communication		
LED PROFIBUS (green)	PROFIBUS communication active				–		
LED power (green)	power on						
LED config error (red)	configuration error						
LED U ASi (green)	ASi voltage OK						
LED ASi active (green)	ASi normal operation active						
LED prg enable (green)	automatic addresses programming enabled						
LED prj mode (yellow)	configuration mode active						
LED AUX (green)	–	auxiliary power				–	auxiliary power
LEDs 1.Y1, 1.Y2, 2.Y1, 2.Y2 (EDM/Start) (yellow)	–	state of inputs: off: open on: close	–	state of inputs: off: open on: close	–		
LEDs K1 ... K4 (green)	–	state of outputs: off: open on: close	–	state of outputs: off: open on: close	–		
LEDs SI1 ... SI6 (yellow)	–		state of inputs: off: open on: close	–		state of inputs: off: open on: close	
LEDs SO1 ... SO6 (yellow)	–		state of outputs: off: open on: close	–		state of outputs: off: open on: close	
<b>UL-specifications (UL508)</b>							
External protection	An isolated source with a secondary open circuit voltage of ≤30 V <sub>DC</sub> with a 3 A maximum over current protection. Over current protection is not required when a Class 2 source is employed.						
In general	UL mark does not provide UL certification for any functional safety rating or aspects of the above devices.						
cTÜV <sub>us</sub>	the devices • BWU2479 • BWU2598 • BWU2615 • BWU2647 from Bihl + Wiedemann GmbH were safety certified by TÜV Rheinland of North America, Inc. according to UL-standards and meet the safety requirements for the North American market.						
Applied standards	EN 60529 EN 62026-2 EN 61000-6-2 EN 61000-6-4 EN 62061, SIL 3 EN 61508, SIL 3 EN ISO 13849-1, Performance-Level e EN ISO 13849-2						

# ASi-3 Gateways, PROFIsafe via PROFIBUS or PROFINET

Article no.	BWU2479	BWU2598	BWU2615	BWU2819	BWU2647	BWU2805	BWU2794 / BWU3367
<b>Environment</b>							
Operating altitude	max. 2000 m						
Ambient temperature	0 °C ... +55 °C						
Storage temperature	-25 °C ... +85 °C						
Housing	stainless steel, for DIN rail mounting						
Protection category	IP20						
Maximum tolerable shock and vibration stress	according EN 61131-2						
Voltage of insulation	≥ 500 V						
Weight	800 g						
Dimensions (W / H / D in mm)	75 / 120 / 96	100 / 120 / 106			109 / 120 / 96	85 / 120 / 106	109 / 120 / 106

(1) **ASi Power24V**

The device can be operated directly on a 24 V (PELV) power supply. The gateway has been optimized with integrated data coupling coils and adjustable self-resetting fuses for safe use of powerful 24 V power supplies.

Article no.	BWU2479 / BWU2805	BWU2598 / BWU2615 / BWU2647	BWU2794 / BWU2819 / BWU3367
<b>Safety monitor</b>			
Start delay	–	< 10 s	
Max. turn-off time	< 40 s		
Antivalent switches for local inputs	–		yes
Standstill monitors for local inputs	–		6 axes up to 50 Hz <sup>(2)</sup>
Speed monitors for local inputs	–		3 to 6 axes up to 400 Hz <sup>(3)</sup>
<b>Connection</b>			
Connection	–	COMBICON	
Length of connector cable	–	I/O: max. 15 m	unlimited <sup>(4)</sup>
<b>Input</b>			
Inputs Safety	–		3 x 2 channels <sup>(5)</sup>
Inputs digital, EDM	–	4	up to 6 standard inputs <sup>(5)</sup>
Switching current	–	30 mA (T = 100 µs), continuously 4 mA at 24 V	15 mA (T = 100 µs), continuously 4 mA at 24 V
Power supply	–	out of ASi	out of AUX
<b>Output</b>			
Number of release circuits on the monitor	–	4	6
Outputs	–	relay outputs (output circuits 1 and 2) max. contact load <sup>(1)</sup> : 3 A <sub>AC-15</sub> at 30 V, 3 A <sub>DC-13</sub> at 30 V	semiconductor output max. contact load: 1,2 A <sub>DC-13</sub> at 30 V, Σ = 7,2 A in sum <sup>(6)</sup>
	–	semiconductor outputs (output circuits 3 and 4) max. contact load: 0,5 A <sub>DC-13</sub> at 30 V	
Power supply (semiconductor outputs)	–	out of AUX	
Test pulse (semiconductor outputs)	–	if output is on: minimum interval between 2 test pulses: 250 ms (as from Safety Version 4.3); maximum pulse width 1 ms	if output is on: minimum interval between 2 test pulses: 250 ms; maximum pulse width 1 ms

(1) Protection via external fuse, max. 4 A semi time-lag.

(2) connection at all SI or SO terminals possible.

(3) connection only at terminals SO1 ... SO6 configured as standard inputs (see "Variations of terminal configuration for BWU2794, BWU2819, BWU3367")

(4) loop resistance ≤ 150 Ω

# ASi-3 Gateways, PROFIsafe via PROFIBUS or PROFINET

(5) see "Variations of terminal configuration for BWU2794, BWU2819, BWU3367"

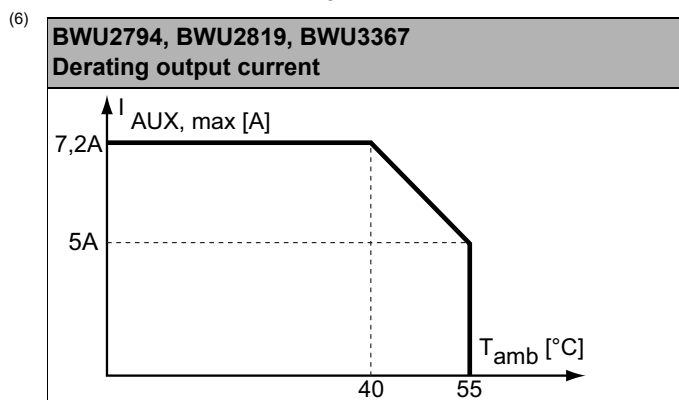

Article no.	Operating current		
	Master power supply, ca. 300 mA out of ASi circuits	Master power supply, max. 300 mA out of ASi circuit 1 (approx. 70 mA ... 300 mA), max. 300 mA out of ASi circuit 2 (approx. 70 mA ... 300 mA); in sum max. 370 mA	Version „1 gateway, 1 power supply, for 2 ASi networks“, approx. 300 mA (PELV voltage)
BWU2479	•	-	-
BWU2598	-	•	-
BWU2615	-	-	•
BWU2647	-	-	•
BWU2794	-	-	•
BWU2805	-	-	•
BWU2819	-	-	•
BWU3367	-	-	•

	BWU2479 / BWU2598	BWU2615 / BWU2647 / BWU2794 / BWU2805 / BWU2819 / BWU3367
Redundant power supply out of ASi: all fundamental functions of the device remain available even in case of power failure in one of the two ASi networks	-	-
Current measurement of the ASi circuits	-	•
Self-resetting adjustable fuses	-	•
ASi earth fault monitor distinguishes between ASi cable and sensor cable	-	•
In version „1 gateway, 1 power supply for 2 ASi circuits“: only 1 gateway + 1 ASi power supply is needed for both 2 ASi circuits	•	•

## Safety outputs block diagram BWU2598, BWU2615, BWU2647:

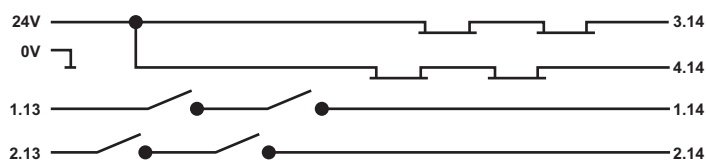

# ASi-3 Gateways, PROFIsafe via PROFIBUS or PROFINET

## Safety outputs block diagram BWU2794, BWU2819, BWU3367

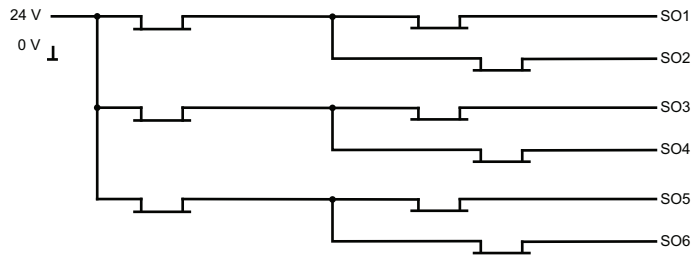

## Variations of terminal configuration for BWU2794, BWU2819, BWU3367

Terminal	Safe output	Safe input for mechanical contacts in combination with T1, T2 <sup>(1)</sup>	Safe antivalent input <sup>(1)</sup>	Safe electronic input <sup>(1)</sup>	Standard input <sup>(1)</sup>
SI1,2	–	•	•	•	•
SI3,4	–	•	•	•	•
SI5,6	–	•	•	•	•
SO1,2 <sup>(2)</sup>	•	•	•	–	•
SO3,4 <sup>(2)</sup>	•	•	•	–	•
SO5,6 <sup>(2)</sup>	•	•	•	–	•

(1) Inputs may only be supplied by the same 24 V source as the device itself.

(2) If outputs are configured as inputs, the input current has to be limited by an external element at  $\leq 100\text{mA}$

## Connections: Gateway + Safety Monitor:

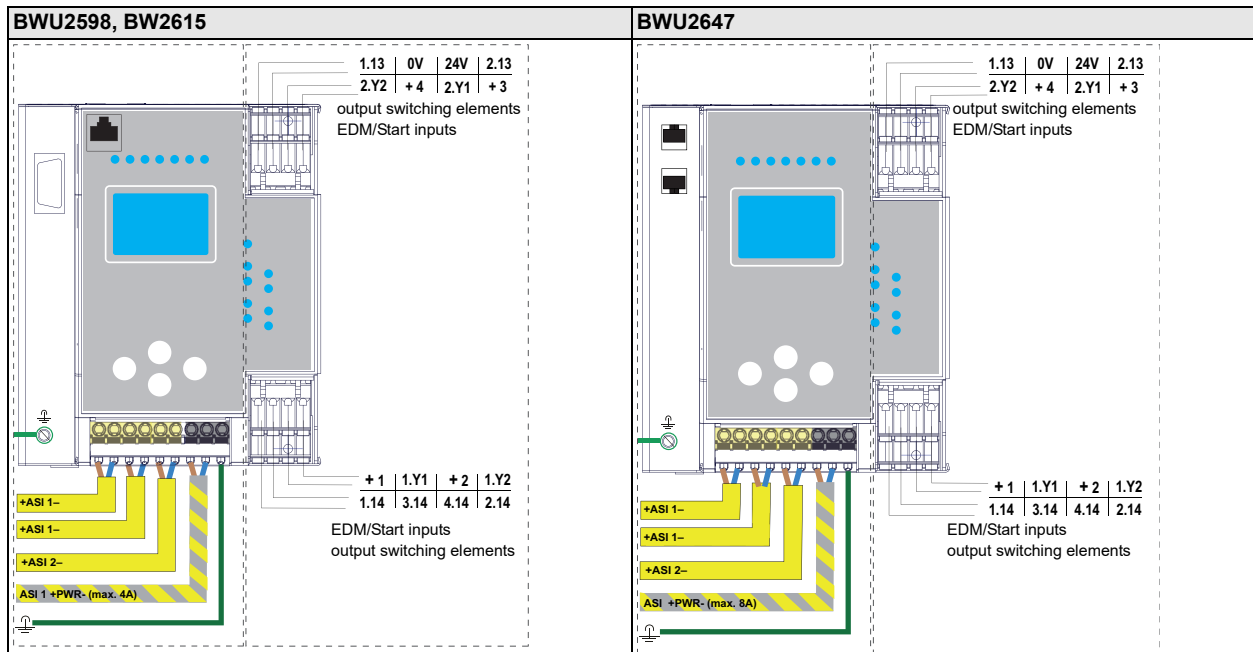

# ASi-3 Gateways, PROFIsafe via PROFIBUS or PROFINET

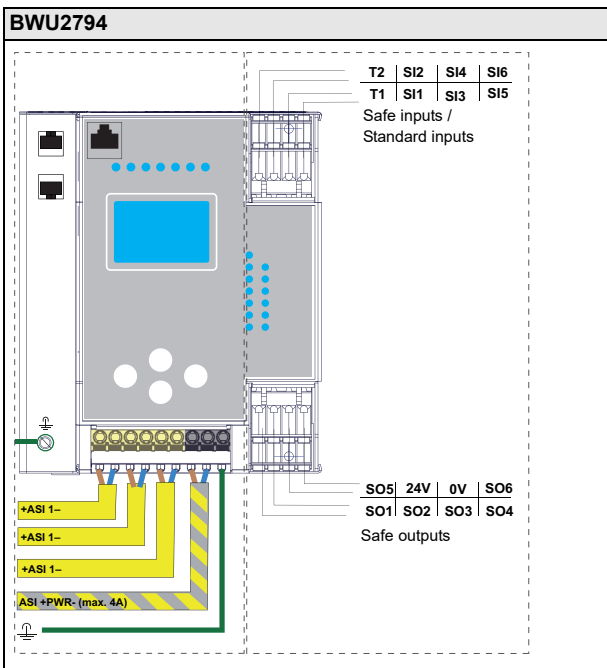
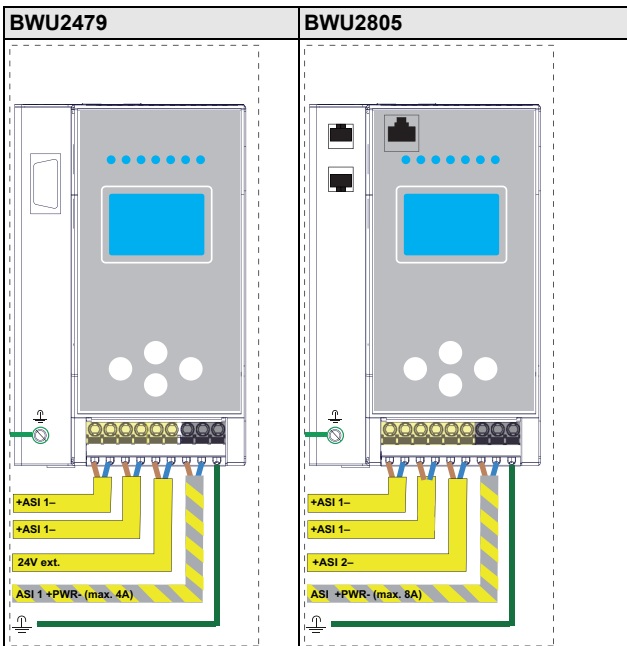

Connection	Description
SI1, SI3, SI5	Safe input terminal (T1)
SI2, SI4, SI6	Safe input terminal (T2)
T1	Clock output 1
T2	Clock output 2
SO1 ... SO6	Safe semiconductor outputs 1 ... 6
24V, 0V	Power supply for local I/Os
+ASI 1-	Connection of ASi circuit
ASI +PWR-	Power supply for Gateway and ASi networks

# ASi-3 Gateways, PROFIsafe via PROFIBUS or PROFINET

BWU2819	Connection	Description																
<p> <table border="1"> <tr><td>T2</td><td>SI2</td><td>SI4</td><td>SI6</td></tr> <tr><td>T1</td><td>SI1</td><td>SI3</td><td>SI5</td></tr> </table>           Safe inputs / Standard inputs         </p> <p> <table border="1"> <tr><td>SO5</td><td>24V</td><td>0V</td><td>SO6</td></tr> <tr><td>SO1</td><td>SO2</td><td>SO3</td><td>SO4</td></tr> </table>           Safe outputs         </p> <p>           +ASI 1-            +ASI 1-            +ASI 1-            +ASI +PWR- (max. 4A)         </p>	T2	SI2	SI4	SI6	T1	SI1	SI3	SI5	SO5	24V	0V	SO6	SO1	SO2	SO3	SO4	SI1, SI3, SI5	Safe input terminal (T1)
	T2	SI2	SI4	SI6														
	T1	SI1	SI3	SI5														
	SO5	24V	0V	SO6														
	SO1	SO2	SO3	SO4														
	SI2, SI4, SI6	Safe input terminal (T2)																
	T1	Clock output 1																
	T2	Clock output 2																
	SO1 ... SO6	Safe semiconductor outputs 1 ... 6																
	24V, 0V	Power supply for local I/Os																
+ASI 1-	Connection of ASi circuit																	
ASI +PWR-	Power supply for Gateway and ASi networks																	

BWU3367	Connection	Description																
<p> <table border="1"> <tr><td>T2</td><td>SI2</td><td>SI4</td><td>SI6</td></tr> <tr><td>T1</td><td>SI1</td><td>SI3</td><td>SI5</td></tr> </table>           Safe inputs / Standard inputs         </p> <p> <table border="1"> <tr><td>SO5</td><td>24V</td><td>0V</td><td>SO6</td></tr> <tr><td>SO1</td><td>SO2</td><td>SO3</td><td>SO4</td></tr> </table>           Safe outputs         </p> <p>           +ASI 1-            +ASI 1-            +ASI 2-            +ASI +PWR- (max. 8A)         </p>	T2	SI2	SI4	SI6	T1	SI1	SI3	SI5	SO5	24V	0V	SO6	SO1	SO2	SO3	SO4	SI1, SI3, SI5	Safe input terminal (T1)
	T2	SI2	SI4	SI6														
	T1	SI1	SI3	SI5														
	SO5	24V	0V	SO6														
	SO1	SO2	SO3	SO4														
	SI2, SI4, SI6	Safe input terminal (T2)																
	T1	Clock output 1																
	T2	Clock output 2																
	SO1 ... SO6	Safe semiconductor outputs 1 ... 6																
	24V, 0V	Power supply for local I/Os																
+ASI 1-, +ASI 2-	Connection of ASi circuits																	
ASI +PWR-	Power supply for Gateway and ASi networks																	

## Accessories:

- Safe contact expander, 1 or 2 independent channels (art. no. BWU2548 / BWU2539)
- Chip card, memory capacity 128 KB (art. no. BW2222)
- Bihl+Wiedemann Suite - Safety Software for Configuration, Diagnostics and Commissioning (art. no. BW2916)
- Power supplies, e.g.: ASi power supply, 4 A (art. no. BW1649), ASi power supply, 8 A (art. no. BW1997) (further power supply units can be found at [www.bihl-wiedemann.de/en/products/accessories/power-supplies](http://www.bihl-wiedemann.de/en/products/accessories/power-supplies))

## For devices with PROFIBUS interface:

- Serial PROFIBUS Master (art. no. BW1258)
- PROFIBUS-DP Master simulator (art. no. BW1257)

## For devices with PROFINET interface:

- PROFINET Master simulator Plus (art. no. BW3057)