



2 x 2 connectors for profile cable

compact housing, IP67



(Figure similar)

Figure	Type	Inputs analog	Outputs analog	M12 connection	Input voltage (sensor supply) ⁽¹⁾	Output voltage (actuator supply) ⁽²⁾	ASi connection ⁽³⁾	ASi address ⁽⁴⁾	Art. no.
	IP67, 4 x M12	2 x 4 ... 20 mA	–	Signal at pin 2 / pin 4	out of ASi	–	ASi profile cable	1 AB address	BWU3100
	IP67, 4 x M12	2 x 0 ... 10V	–	Signal at pin 2 / pin 4	out of ASi	–	ASi profile cable	1 AB address	BWU3102
	IP67, 4 x M12	2 x Pt100	–	Signal at pin 1 / pin 3	out of ASi	–	ASi profile cable	1 AB address	BWU3104
	IP67, 4 x M12	–	2 x 0 ... 20 mA	Signal at pin 1 / pin 3	–	out of AUX	ASi profile cable	1 single address	BWU3105
	IP67, 4 x M12	–	2 x 0 ... 20 mA	Signal at pin 2 / pin 4	–	out of AUX	ASi profile cable	1 single address	BWU3106
	IP67, 4 x M12	–	2 x 0 ... 10 V	Signal at pin 1 / pin 3	–	out of AUX	ASi profile cable	1 single address	BWU3107

- (1) **Input voltage (sensor supply):** inputs are supplied by ASi or by AUX (auxiliary 24 V power). If supplied by ASi, inputs shall not be connected to earth or to external potential.
- (2) **Output voltage (actuator supply):** outputs are supplied by ASi or by AUX (auxiliary 24 V power). If supplied by ASi, outputs shall not be connected to earth or to external potential
- (3) **ASi connection:** the connection to ASi as well to AUX (auxiliary 24 V power) is made via yellow resp. black ASi profile cable with piercing technology or via M12 socket (in IP20 via clamps).
- (4) **ASi address:** AB address (max. 62 AB addresses/ASi network), 2 AB addresses (max. 31 modules with 2 AB addresses), Single addresses (max. 31 Single addresses/ASi network), mixed use allowed.
For modules with two ASi nodes the second ASi node is turned off as long as the first ASi node is addressed to address "0".
Upon request, ASi nodes are available with specific ASi address profiles.

Article No.	BWU3100	BWU3102	BWU3104
General data			
Device type	input		
Connection			
ASi/AUX connection	profile cable and piercing		
Periphery connection	M12, signal at pin 2 / pin 4	M12, signal at pin 1 / pin 3	
Length of connector cable	I/O: max. 15 m ⁽¹⁾		
ASi			
Profile	S-7.A.9		
Address	1 AB address		
Required Master profile	≥ M4		
As of ASi specification	3.0		
Operating voltage	30 V _{DC} (18 ... 31,6 V)		
Max. current consumption	165 mA	< 80 mA	
Max. current consumption without sensor / actuator supply	45 mA	< 80 mA	
AUX			
Operating voltage	-		
Max. current consumption	-		
Input			
Number	2		
Resolution	normal: 14 bit, fast: 12 bit		14 Bit
Range of value	4000 ... 20000 dec. / 0 ... 27648 dec. ⁽²⁾	0 ... 10000 dec. / 0 ... 27648 dec. ⁽²⁾	-2000 ... +8500 dec. / -12000 ... 13000 dec
Internal resistance	-	130 kΩ	-
Max. voltage drop	< 5 V	-	
Max. input voltage	-	25 V	-
Max. input current	26 mA (internally limited)	-	
Power supply	out of ASi		
Power supply of attached sensors	max. 80 mA (max. 120 mA at +40 °C) ⁽³⁾		-
Display			
LED PWR (green)	on: ASi voltage on flashing: ASi voltage on, but peripheral fault ⁽⁴⁾ or address 0 off: no ASi voltage		
LED FLT/FLAUT (red)	on: no data exchange, ASi address 0 or ASi node offline flashing: peripheral fault ⁽⁴⁾ off: no ASi voltage		
LED AUX (green)	-		
LED I1, I2 (yellow)	state of channel I1, I2: on: analog signal within range of values flashing: analog signal outside range of values out: channel is switched off		state of channel I1, I2: on: analog signal within range of values flashing: analog signal outside range of values out: no Pt100 sensor connected

Article No.	BWU3100	BWU3102	BWU3104
Environment			
Applied standards	EN 61000-6-2 EN 61000-6-4 EN 60529		
Can be used in passively safe paths up to SIL3/PLe	yes ⁽⁵⁾		
Operating altitude	max. 2000 m		
Ambient temperature	-30 °C ... +70 °C ⁽³⁾		
Storage temperature	-25 °C ... +85 °C		
Housing	plastic, for DIN rail mounting or for screw mounting ⁽⁶⁾		
Protection category	IP67		
Maximum tolerable shock and vibration stress	≤15g, T≤11 ms 5 ... 500 Hz: 5 Hz, 50 mm _{pp} ; 7,6 Hz, 50 mm _{pp} /6g; 500 Hz, 6g		
Insulation voltage	≥500 V		
Weight	100 g		
Dimensions (W / H / D) in mm	45 / 80 / 42		

(1) loop resistance: ≤150 Ω

(2) Siemens scale

(3)

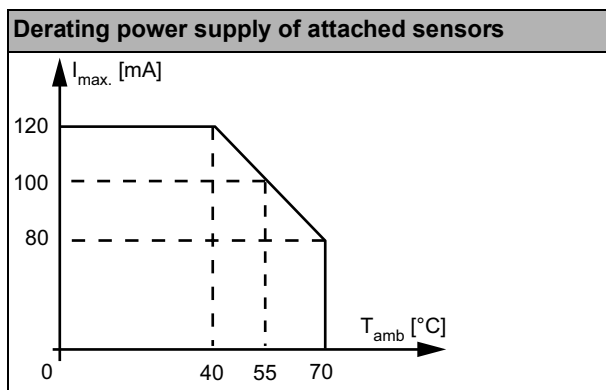

(4) See table "Peripheral fault indication"

(5) The module is suitable for use in passively safe paths as it has no connection to an AUX potential.

(6) Depending on substructure module (see accessories). The substructure module is not included in the scope of delivery.

Article No.	BWU3105	BWU3106	BWU3107
General data			
Device type	output		
Connection			
ASi/AUX connection	profile cable and piercing		
Periphery connection	M12, signal at pin 1 / pin 3	M12, signal at pin 2 / pin 4	M12, signal at pin 1 / pin 3
Length of connector cable	I/O: max. 15 m ⁽¹⁾		
ASi			
Profile	S-7.3.5		
Address	1 single address		
Required Master profile	≥M3		
As of ASi specification	2.1		
Operating voltage	30 V _{DC} (18 ... 31,6 V)		
Max. current consumption	<100 mA		
AUX			
Operating voltage	24 V _{DC} (18 ... 30 V)		
Max. current consumption	4 A		

Article No.	BWU3105	BWU3106	BWU3107
Output			
Number	2		
Resolution	16 Bit (1 μ A)		16 Bit (1 mV)
Range of value	0 ... 20000 dec.		0 ... 10000 dez.
Actuator resistance	max. 600 Ω		min. 3,3 k Ω
Max. output voltage	-		11,5 V
Max. output current	23 mA		-
Power supply	out of AUX		
Power supply of attached actuators	max. 1,5 A (max. 2 A at +50 °C) per output ⁽²⁾		
Display			
LED PWR (green)	on: ASi voltage on flashing: ASi voltage on, but peripheral fault ⁽³⁾ or address 0 off: no ASi voltage		
LED FLT/FLAUT (red)	on: no data exchange, ASi address 0 or ASi node offline flashing: peripheral fault ⁽³⁾ off: ASi node online		
LED AUX (green)	on: 24 V _{DC} AUX off: no 24 V _{DC} AUX		
LED O1, O2 (yellow)	state of channel O1, O2: on: analog signal within range of values flashing: analog signal outside range of values		
Environment			
Applied standards	EN 61000-6-2 EN 61000-6-4 EN 60529		
Can be used in passively safe paths up to SIL3/PLe	no ⁽⁴⁾		
Operating altitude	max. 2000 m		
Ambient temperature	-30 °C ... +70 °C ⁽²⁾		
Storage temperature	-25 °C ... +85 °C		
Housing	plastic, for DIN rail mounting or for screw mounting ⁽⁵⁾		
Protection category	IP67		
Maximum tolerable shock and vibration stress	$\leq 15g$, $T \leq 11$ ms 5 ... 500 Hz: 5 Hz, 50 mm _{pp} ; 7,6 Hz, 50 mm _{pp} /6g; 500 Hz, 6g		
Insulation voltage	≥ 500 V		
Weight	100 g		
Dimensions (W / H / D) in mm	45 / 80 / 42		

(1) loop resistance: $\leq 150 \Omega$

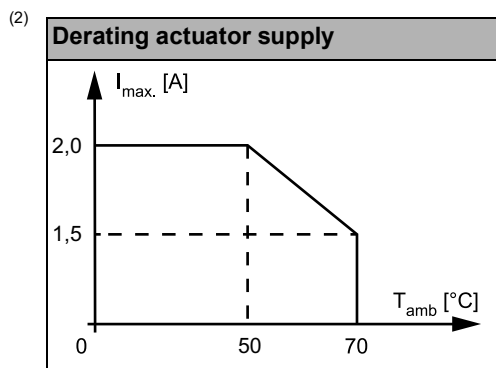

(3) See table "Peripheral fault indication"

(4) The module is not suitable for use in passively safe paths because an exclusion of errors cannot be assumed for the connection of the two potentials, ASi and AUX.

(5) Depending on substructure module (see accessories). The substructure module is not included in the scope of delivery.

UL-specifications (UL508) BWU3100, BWU3102, BWU3104, BWU3105, BWU3106, BWU3107	
External protection	An isolated source with a secondary open circuit voltage of $\leq 30 V_{DC}$ with a 3 A maximum over current protection. Over current protection is not required when a Class 2 source is employed.
In general	UL mark does not provide UL certification for any functional safety rating or aspects of the above devices.

Article No.	Peripheral fault indication		
	analog signal outside range of values	at least 1 configured channel not connected	overload sensor supply
BWU3100	•	•	-
BWU3102	•	-	•
BWU3104	• (1)	•	-
BWU3105	•	•	-
BWU3106	•	•	-
BWU3107	•	•	-

(1) no Pt100 sensor connected

Programming

Bit	Bit setting			
	input			
	P3	P2	P1	P0
BWU3100	not used (1)	1: 0V and Sig- internally bridged	1: 4000 ... 20000 dec. 0: 0 ... 27648 dec. (2)	1: peripheral fault is indicated 0: peripheral fault is not indicated
BWU3102		0: 0V and Sig- not bridged	1: 0 ... 10000 dec. 0: 0 ... 27648 dec. (2)	
BWU3104		1: -200 °C ... +850 °C 0: -120 °C ... +130 °C	1: 2 wire mode 0: 4 wire mode	
	output			
BWU3105 / BWU3106 BWU3107	not used	1: peripheral fault is indicated 0: peripheral fault is not indicated	not used	1: Watchdog on 0: Watchdog off

(1) Channel 2 on/off parameterized via ID1.

(2) Siemens scale

ID1 code	BWU3100 / BWU3102 / BWU3104
0; 2; 3	channel 1, 14 bit
1	channel 1, 12 bit
4; 5; 7 (default)	channel 1 and 2, 14 bit
6	channel 1 and 2, 12 bit

Pin assignment

Signal name	Explanation
Ix	analog input x
Ox	analog output x
24 V _{ext.out}	power supply, out of external voltage, positive pole (AUX, actuator supply)
0 V _{ext.out}	power supply, out of external voltage, negative pole (AUX, actuator supply)
24 V _{out of ASi}	power supply, out of ASi, positive pole (sensor supply)
0 V _{out of ASi}	power supply, out of ASi, negative pole (sensor supply)

Connections							
Article No.	M12 connection	Mark	Pin1	Pin2	Pin3	Pin4	Pin5
BWU3100 BWU3102	X1	I1	24V _{out of ASi}	Sig+	0V _{out of ASi} ⁽¹⁾	Sig- ⁽¹⁾	Shield
	X2	I2	24V _{out of ASi}	Sig+	0V _{out of ASi} ⁽¹⁾	Sig- ⁽¹⁾	Shield
	X3	not used					
	X4	not used					
	ADDR (protection cap)	connection for ASi-3 addressing plug					
BWU3104	X1	I1	CH+	CHS+	CH-	CHS-	Shield
	X2	I2	CH+	CHS+	CH-	CHS-	Shield
	X3	not used					
	X4	not used					
	ADDR (protection cap)	connection for ASi-3 addressing plug					
BWU3105 BWU3107	X1	O1	Sig+	24V _{ext.out}	Sig-	0V _{ext.out}	Shield
	X2	O2	Sig+	24V _{ext.out}	Sig-	0V _{ext.out}	Shield
	X3	not used					
	X4	not used					
	ADDR (protection cap)	connection for ASi-3 addressing plug					
BWU3106	X1	O1	24V _{ext.out}	Sig+	0V _{ext.out}	Sig-	Shield
	X2	O2	24V _{ext.out}	Sig+	0V _{ext.out}	Sig-	Shield
	X3	not used					
	X4	not used					
	ADDR (protection cap)	connection for ASi-3 addressing plug					

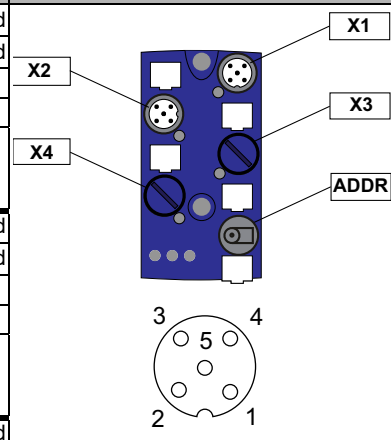

⁽¹⁾ Pin 3 and pin 4 bridgeable internally via parameter bit P2.

Mounting according to cable direction

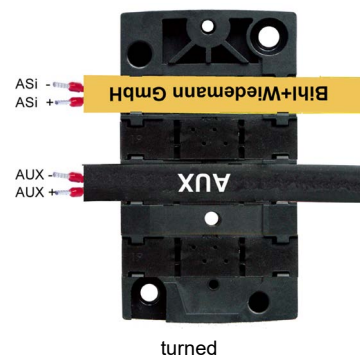
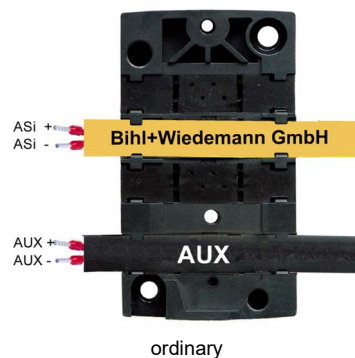

Line termination with sealing profiles / as junction

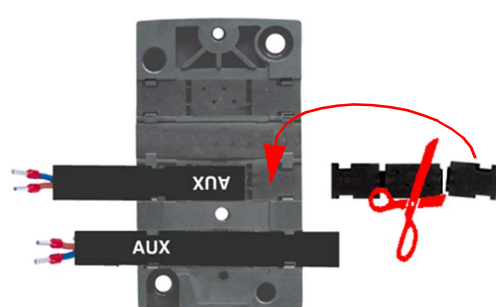
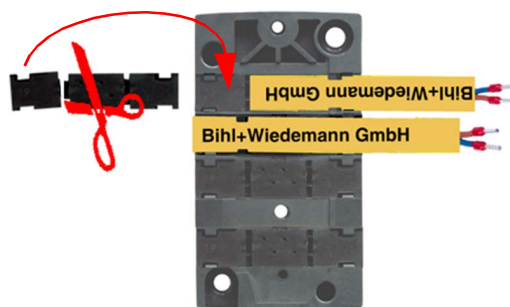
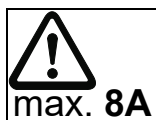

Accessories:

- ASi substructure module for 4 channel module in 45 mm housing (art. no. BW2349)
- ASi substructure module (CNOMO) for 4 channel module in 45 mm housing (art. no. BW2350)
- Universal protection cap ASi-5/ASi-3 for M12 sockets, IP67 (art. no. BW4056)
- Sealing profile IP67 (IDC plug), 45 mm (art. no. BW3283)
- ASi-5/ASi-3 Address Programming Device (art. no. BW4708)