

Active Distributor ASi, IP67, M12, 3I/4O



2 x connectors for profile cable

Periphery connection via
4 x M12 cable sockets, straight, 5 poles

For SEW MOVIMOT with binary control AVSX







(figure similar)

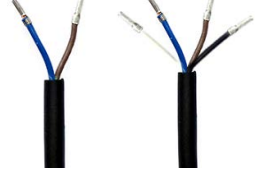

Figure	Type	Number of Drives	Inputs digital	Outputs digital	Input voltage (sensor supply) ⁽¹⁾	Output voltage (actuator supply) ⁽²⁾	ASi connection ⁽³⁾	Connection ⁽⁴⁾	ASi address ⁽⁵⁾	Special function	Art. no.
	IP67, depth 35 mm	1	2	–	out of AUX	out of AUX	ASi profile cable	4 x M12 cable sockets, straight, 5 poles	1 AB address	for connecting SEW MOVIMOT to ASi	BWU3751

- (1) **Input voltage (sensor supply):** inputs are supplied by ASi or by AUX (auxiliary 24 V power). If supplied by ASi, inputs shall not be connected to earth or to external potential.
- (2) **Output voltage (actuator supply):** outputs are supplied by ASi or by AUX (auxiliary 24 V power). If supplied by ASi, outputs shall not be connected to earth or to external potential
- (3) **ASi connection:** the connection to ASi as well to AUX (auxiliary 24 V power) is made via yellow resp. black ASi profile cable with piercing technology or via M12 socket (in IP20 via clamps).
- (4) **Connection:** further connection options are available on request.

M12 cable socket, angled	M12 cable socket, straight	M8 cable socket, straight	round cable / connecting wires	Push in terminals
PUR line, oil resistant				
				

- (5) **ASi address:** 1 AB address (max. 62 AB addresses/ASi network), 2 AB addresses (max. 31 modules with 2 AB addresses), Single addresses (max. 31 Single addresses/ASi network), mixed use allowed.
For modules with two ASi nodes the second ASi node is turned off as long as the first ASi node is addressed to address "0".
Upon request, ASi nodes are available with specific ASi address profiles.

Article No.		BWU3751
General data		
Device type		input/output
Connection		
ASi/AUX connection		profile cable and piercing
Periphery connection		4 x M12 cable sockets, straight, 5 poles
Special function		suitable for SEW MOVIMOT (AVSX)
Length of connector cable		2 m max. allowed tensile strain 10 N
ASi		
Profile		S-7.A.7 (ID1=7 fixed)
Address		1 AB address
Required Master profile		≥M4
As of ASi specification		3.0
Operating voltage		30 V (18 ... 31.6 V)
Max. current consumption		45 mA
Max. current consumption without sensor/ actuator supply		45 mA
AUX		
Operating voltage		24 V (18 ... 30 V)
Max. current consumption		3 A
Input		
Number		3
Power supply		out of AUX
Line protection fuse		yes 5 A ⁽¹⁾ slow blow fuse UL certified
Power supply of attached sensors	up to +40 °C	1 A, $\sum (In/Out) \leq 3 A^{(2)}$
	at +55 °C	1 A, $\sum (In/Out) \leq 2 A^{(2)}$
	at +60 °C	1 A, $\sum (In/Out) \leq 1,5 A^{(2)}$
Switching threshold		U < 5 V (low) U > 15 V (high)
Output		
Number		4
Power supply		out of AUX
Output		short-circuit and overload protected according to EN 61131-2
Max. output current	up to +40 °C	1 A per output, $\sum (In/Out) \leq 3 A^{(2)}$
	at +55 °C	1 A per output, $\sum (In/Out) \leq 2 A^{(2)}$
	at +60 °C	1 A per output, $\sum (In/Out) \leq 1,5 A^{(2)}$
Safe disconnection of output voltage		yes up to PLe
Display		
LED ASi/FLT (red/green)		green: ASi voltage on, ASi node online red: ASi voltage on, but ASi node offline yellow/red flashing: address 0 red/green flashing: peripheral fault ⁽³⁾ off: no ASi voltage
LED AUX (green)		on: 24 V _{DC} AUX off: no 24 V _{DC} AUX
LED I1 ... In (yellow)		state of inputs I1 ... I3
LED O1 ... On (yellow)		state of outputs O1 ... O4

Article No.	BWU3751
Environment	
Applied standards	EN ISO 13849-1 PLe EN ISO13849-2 EN 62026-2 EN 61000-6-2 EN 61000-6-3 EN 61131-2 EN 60529
Can be used in passively safe paths up to SIL3/PLe	yes ⁽⁴⁾
Operating altitude	max. 2000 m
Ambient temperature	-30 °C ... +60 °C ^{(2) (5)}
Storage temperature	-25 °C ... +85 °C
Housing	plastic, screw mounting, suitable for cable ducts (installation depth ≥35mm)
Pollution Degree	2
Protection category	IP67 ⁽⁶⁾
Tolerable loading referring to humidity	according to EN 61131-2
Maximum tolerable shock and vibration stress	≤15g, T≤11 ms 10 ... 55 Hz, 0,5 mm amplitude
Insulation voltage	≥500 V
Weight	100 g
Dimensions (W / H / D) in mm	60 / 45 / 35

(1) In the motor module UL approved fuses are placed before the sensor supply connections. A short circuit in the sensor causes this fuse to blow, protecting the connection cable between the module and sensors. After blowing the fuse the module is no longer functional and needs to be replaced.

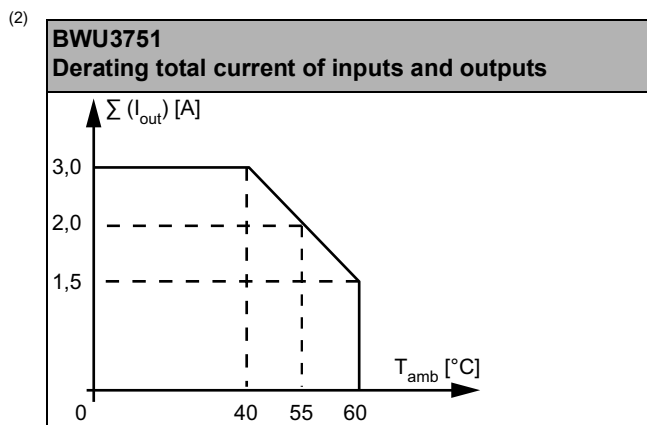
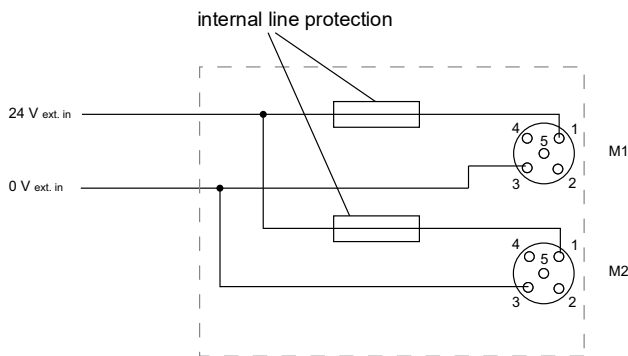

(3) see table "Peripheral fault indication"

(4) The module is suitable for use in passively safe paths because an exclusion of errors can be assumed for the connection of the two potentials, ASi and AUX..

(5) Down to -25 °C with flexibly mounted cable, -30 °C only with fixed mounted cable.

⁽⁶⁾ Protection category IP67 can only be achieved, if also the cable connector fulfills IP67

Article no.	Peripheral fault indication		
	Overload sensor supply	Output short circuited	AUX voltage missing
BWU3751	•	•	•

UL-specifications (UL61010)	
External protection	An isolated source with a secondary open circuit voltage of $\leq 30 V_{DC}$ with a 3 A maximum over current protection. Over current protection is not required when a Class 2 source is employed.
In general	UL mark does not provide UL certification for any functional safety rating or aspects of the above devices.

Programming	Parameter bit			
	D3	D2	D1	D0
	input			
BWU3751	–	I3	I2	I1
	output			
BWU3751	O4	O3	O2	O1
	parameter bit			
	P3	P2	P1	P0
BWU3751	not used	0= on / 1= off (synchronous I/O mode)	0= off / 1= on (peripheral fault, if AUX missing)	0= off / 1= on (Watchdog)

Pin assignment

Signal name	Explanation
I _x	digital input x
O _x	digital output x
24V _{ext out}	power supply, out of external voltage, positive pole (AUX, actuator supply)
0V _{ext out}	power supply, out of external voltage, negative pole (AUX, actuator supply)
24V _{out of ASi}	power supply, out of ASi, positive pole (sensor supply)
0V _{out of AS-}	power supply, out of ASi, negative pole (sensor supply)
ASi+, ASi-	connection to ASi bus
n.c. (not connected)	not connected

Connections:						
Article no.	M12 connection	Pin1 (BN)	Pin2 (WH)	Pin3 (BU)	Pin4 (BK)	Pin5 (–)
BWU3751	X1	O1 (24 V)	O4 (f1/f2)	0 V ext out	I1 (K1b)	n.c.
	X2	24 V ext out	n.c.	0 V ext out	I3	n.c.
	X3	n.c.	O2 (R)	0 V ext out	O3 (L)	n.c.
	X4	24 V ext out	n.c.	0 V ext out	I2	n.c.

Line termination with sealing profile



max. IP54

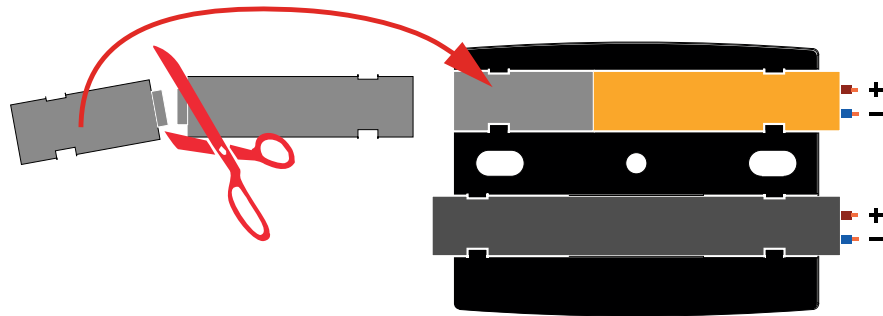

Accessories:

- Sealing profile IP67 (IDC plug), 60 mm (art. no. BW3282)
- ASi-5/ASi-3 Address Programming Device (art. no. BW4708)
- ASi addressing cable with M12 connector, connecting cable for handheld ASi address programming devices for the addressing of active distributors (art. no. BW3304)
- ASi addressing cable with COMBICON connector, Connecting cable for ASi Master/Gateways for the addressing of active distributors (art. no. BW3305)