

ABSOLUTE ENCODERS

AST58™

SSI® Single-turn Line

- Standard dimension Ø58mm
- Hollow or solid shaft
- High resolution
- High accuracy



APPLICATIONS

- Motion control
- Conveyor lines
- Automated machinery



MECHANICAL AND ENVIRONMENTAL SPECIFICATIONS

Case dimension	Ø 58 mm, depth 48 mm
Shaft dimension	Hollow Ø 15 mm, solid Ø 6 or 10 mm
Shaft loading (axial and radial)	100 N max.
Shaft rotational speed	9000 rpm continuous, 12000 rpm temporary
Bearings life	400x10 ⁶ rev. min. (10 ⁹ rev. min. with shaft loading of 20 N max.)
Weight	0.3 kg (10 oz) ca.
Case material	Aluminium anticorrosion UNI EN AW-6082
Flange material	Aluminium anticorrosion UNI EN AW-6082
Shaft material	Stainless steel non-magnetic UNI EN 4305
Bearings material	ABEC 5
Mechanical protection	IP65
Shock resistance	100g, 6 ms (MIL STD 202F)
Vibration resistance	10 g 5-2000 Hz (MIL STD 202F)
Operating temperature	-25 to +85°C (-13 to 185°F)
Storage temperature	-40 to +100°C (-40 to 212°F), 98% R.H. non condensing

Note: specifications subject to changes without prior notice, please refer to the user manual received with the product for mounting, wiring and operation.

ELECTRICAL SPECIFICATIONS

Resolution	13 bit = up to 8192 count per revolution (CPR)
Counting frequency	> 150 kHz max.
Accuracy	±0.02°
Output code	GRAY
Output circuit	SSI® (RS422) tree format
Power supply	7.5 – 34 Vdc
Consumption	0.9 W
Input functions	Counting direction and Zero setting/Preset
Connection	8-poles shielded cable 1.5m or connector M12 or M23
Protection	Polarity inversion and short circuit
EMC	According to EN61000-4-2/A1 and EN61000-4-4
Light source	Ga-Al diodes
Optoelectronic life	> 100.000 hrs

ELECTRICAL CONNECTIONS

SSI®	0 Vdc	+Vdc	Clock in+	Clock in-	Data out+	Data out-	Preset	Direction	Ground
Wire	White	Brown	Green	Yellow	Gray	Pink	Blue	Red	Shield
M12 pin	1	2	3	4	5	6	7	8	Case
M23 pin	1	2	3	4	5	6	7	8	Case

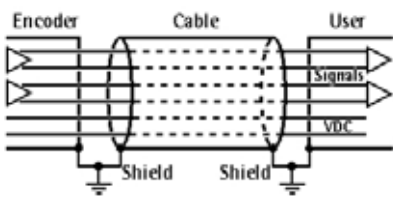

8-poles cable

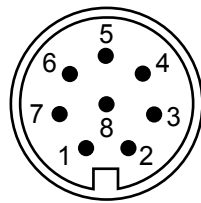

M12 8-pin connector

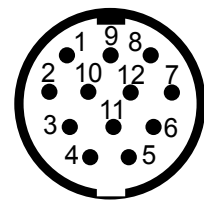

M23 12-pin connector ccw
(only 8 pins are used)

NOTE: view and pin-out of the connectors on the encoder side



ABSOLUTE ENCODERS

DIMENSIONS

HOLLOW SHAFT VERSION

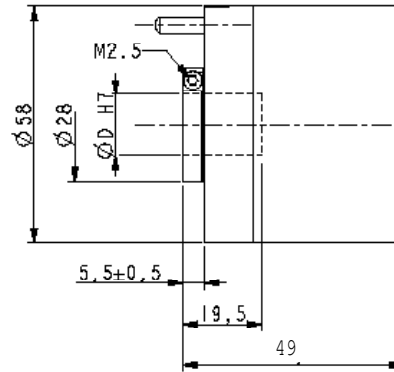
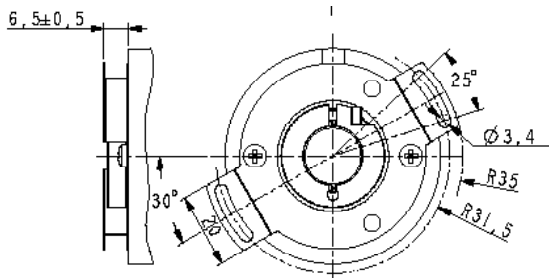

SOLID SHAFT VERSION

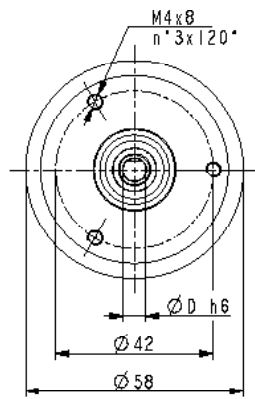

AST58-S06

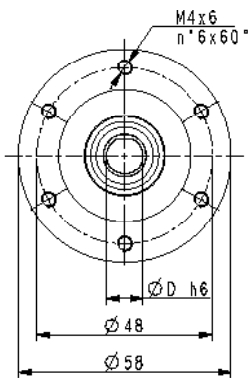
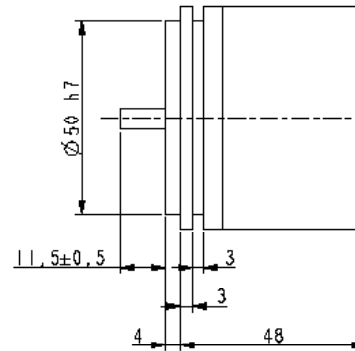

AST58-S10

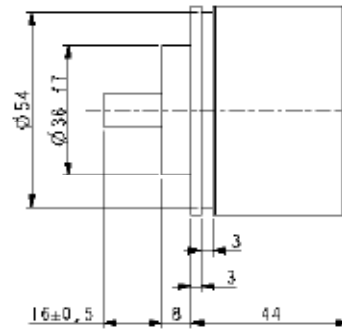

Model selection

SSI® SINGLE-TURN MODELS

SHAFT	CONNECTION	MODEL	ORDER NO.
Hollow shaft • $\varnothing 15$ mm	Cable 1.5m	AST58-H15-13x01-C15	95B081050
	M12 conn.	AST58-H15-13x01-M12	95B081030
	M23 conn.	AST58-H15-13x01-M23	95B081040
Solid shaft • $\varnothing 6$ mm	Cable 1.5m	AST58-S06-13x01-C15	95B080990
	M12 conn.	AST58-S06-13x01-M12	95B080970
	M23 conn.	AST58-S06-13x01-M23	95B080980
Solid shaft • $\varnothing 10$ mm	Cable 1.5m	AST58-S10-13x01-C15	95B081020
	M12 conn.	AST58-S10-13x01-M12	95B081000
	M23 conn.	AST58-S10-13x01-M23	95B081010

ACCESSORIES

DESCRIPTION	MODEL	ORDER NO.
Flexible Aluminium coupling Ø6 mm	FAC06-06	95B081300
Flexible Aluminium coupling Ø10 mm	FAC10-10	95B081310
Flexible standard plastic coupling Ø6 mm	FBC06-06	95B081320
Flexible standard plastic coupling Ø10 mm	FBC10-10	95B081330
Encoder reducing sleeve Ø15 - 6 mm	RS15-06	95B081340
Encoder reducing sleeve Ø15 - 8 mm	RS15-08	95B081350
Encoder reducing sleeve Ø15 - 10 mm	RS15-10	95B081360
Encoder reducing sleeve Ø15 - 11 mm	RS15-11	95B081370
Encoder reducing sleeve Ø15 - 12 mm	RS15-12	95B081380
Encoder reducing sleeve Ø15 - 9.52 mm (3/8")	RS15-3/8	95B081390
Ø58 Encoder fixing clamps (3 kits)	ST-58-KIT	95B081400
Ø58 Encoder mounting bell	ST-58-BELL	95B081410
Ø58 Encoder mounting L-bracket	ST-58-BRKT	95B081420
Ø58 Encoder mounting square flange	ST-58-FLNG	95B081430
Absolute encoder conn. ccw M23 12-poles with 5m cable	CN-M23A-12P-05	95B081290
Absolute encoder conn. ccw M23 12-poles with 10m cable	CN-M23A-12P-10	95B081450
Absolute encoder conn. ccw M23 12-poles without cable	CN-M23A-12P-00	95B081470
Metal M12 8-poles female conn. with 5m cable	CN-M12-08P-05	95B081230
Metal M12 8-poles female conn. with 10m cable	CN-M12-08P-10	95B081240
Metal M12 8-poles female connector without cable	CN-M12-08P-00	95B081250
UL Plastic M12 8-poles female conn. with 3m cable	CS-A1-06-U-03	95ASE1170
UL Plastic M12 8-poles female conn. with 5m cable	CS-A1-06-U-05	95ASE1180
UL Plastic M12 8-poles female conn. with 10m cable	CS-A1-06-U-10	95ASE1190
UL Plastic M12 8-poles female conn. with 15m cable	CS-A1-06-U-15	95ASE1200
UL Plastic M12 8-poles female conn. with 25m cable	CS-A1-06-U-25	95ASE1210
UL Plastic M12 8-poles female conn. with 50m cable	CS-A1-06-U-50	95A252700
UL Plastic M12 8-poles female connector without cable	CS-A1-06-B-NC	95ACC2550

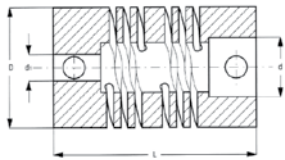

FAC06-06 (L22/D19/d6 mm)
FAC10-10 (L24/D25/d10 mm)

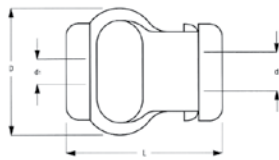

FBC06-06 (L29/D22/d6 mm)
FBC10-10 (L29/D22/d10 mm)

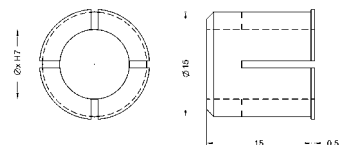

RS15-xx (int. Ø as specified in description)

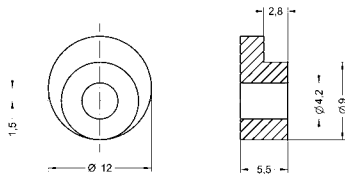

ST58-KIT

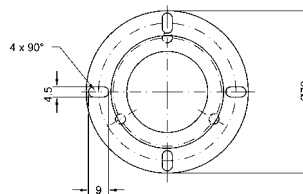

ST58-BELL

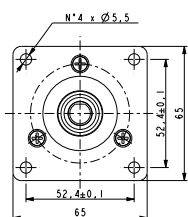
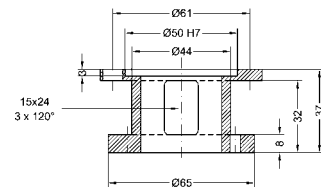

ST58-FLNG

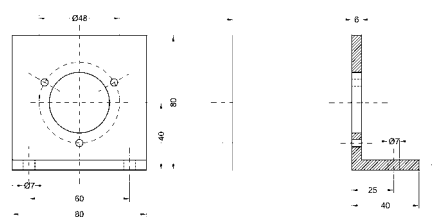

ST58-BRKT