

**ITEM 105763 CET1-AR-CRA-CH-50X-SG-105763**

Description	Technical data	Accessories	Downloads
-------------	----------------	-------------	-----------



**Features**

- › Safety switch with guard locking and integrated evaluation electronics
- › Locking force up to 6500 N
- › Up to 20 switches in series
- › Short circuit monitoring
- › 2 safety outputs (semiconductor outputs)
- › Up to category 4/PL e according to EN ISO 13849-1
- › With 2 plug connectors M12
- › Multicode
- › Approach direction A (default setting on delivery)

**Approach direction**

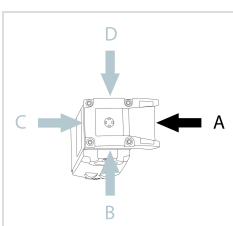

- › Figure  
Horizontal  
Can be adjusted in 90° steps

---

## Safety switch

The device may be operated only in conjunction with the actuator CET-A-....

**Important:** The actuator must be ordered separately.

---

## Multicode evaluation unit

Every suitable actuator is detected by the switch.

---

## Solenoid operating voltage

› DC 24 V +10% -15%

---

## Guard locking type

**CET1 Closed-circuit current principle**, guard locking by spring force.  
Release by applying voltage to the guard locking solenoid.

---

## LED function display

**LED State** Status LED

**LED DIA** Diagnostic LED

**LED 1 rd** freely configurable

**LED 2 gn** freely configurable

---

## Additional connections

**OUT** Monitoring output (semiconductor)

**RST** Reset input

---

## Category according to EN ISO 13849-1

Due to two redundantly designed semiconductor outputs (safety outputs) with internal monitoring suitable for:

› Category 4/PL e according to EN ISO 13849-1

**Important:** To achieve the stated category in accordance with EN ISO 13849-1, both safety outputs (OA and OB) must be evaluated.

The category is dependent on the installation position of the safety switch:

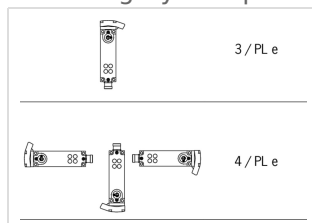

› Figure

## Approvals

## Mechanical values and environment

Housing material		
	Slide	Stainless steel
	Safety switch housing	Die-cast aluminum
Weight		
	Net	1 kg
Ambient temperature		
	At $U_B = 24V$ DC	-20 ... 55 °C
Degree of protection		IP67 [1]
Mechanical life		$1 \times 10^6$
Installation position		Any [2]
Degree of freedom		
	X	$\pm 5$ mm
	Y	$\pm 5$ mm
	Z	$\pm 4$ mm
Ready delay		10 s
Switching frequency		max.0,5 Hz
Connection		2 plug connectors M12, 5 and 8-pin
Approach speed		20 m/min
Guard locking principle		Closed-circuit current principle
Locking force $F_{max}$		6500 N
Locking force $F_{Zh}$		5000 N

## Electrical connection ratings

Operating voltage DC		
	$U_B$	24 V DC -15% ... 15% Reverse polarity protected, regulated, residual ripple < 5%, PELV
	LED1, LED2	24 V DC -15% ... 10%
Current consumption		
	$I_B$	80 mA
	$I_{CM}$	480 mA
Utilization category according to EN 60947-5-2		
	DC-13	24V 200mA [3]
Solenoid operating voltage DC		
	$U_{CM}$	24 V DC -15% ... +10% Reverse polarity protected, regulated, residual ripple < 5%, PELV
Fusing		
	External (operating voltage $U_B$ )	0,25 ... 2 A
	External (operating voltage $U_{CM}$ )	0,5 ... 8 A
Power consumption		
	Solenoid	max.12 W

EMC protection requirements	In acc. with EN IEC 60947-5-3
Solenoid duty cycle	100 %
Degree of contamination (external, according to EN 60947-1)	3
Safety class	EN IEC 61140 III
Switching load	According to UL 24V DC, class 2 <sup>[4]</sup>
<b>Safety outputs OA/OB</b>	
Type of output	Semiconductor outputs, p-switching, short circuit-proof
Output voltage	High U(OA,OB) UB-1,5V ... UB V DC <sup>[5]</sup> Low U(OA,OB) 0 ... 1 V DC
Output current	per safety output 1 ... 200 mA
Off-state current I <sub>r</sub>	max.0,25 mA
Risk time according to EN 60947-5-3	Single device max.400 ms Delay per device 5 ms
Switch-on time	Safety outputs 400 ms
Discrepancy time	Both safety outputs max.10 ms
<b>Monitoring output OUT</b>	
Type of output	Semiconductor output, p-switching, short circuit-proof
Output voltage	OUT 0,8xUB ... UB V DC
Output current	OUT 1 ... 50 mA

## Operating distance

Repeat accuracy R	According to EN 60947-5-2 10 %
-------------------	--------------------------------

## Miscellaneous

For the approval according to UL the following applies	Operation only with UL class 2 power supply, or equivalent measures see operating instructions
--	--

## Reliability values acc. to EN ISO 13849-1

	<b>Monitoring of guard locking and the safety guard position</b>
Category	

	Head upward	3
	Head downward or horizontal	4
Performance Level		PL e
PFH <sub>D</sub>		
	Head upward	$4.29 \times 10^{-8}$
	Head downward or horizontal	$3.1 \times 10^{-9}$
<b>Control of the guard locking</b>		
Category		Depending on external control of guard locking <b>[6]</b>
Performance Level		Depending on external control of guard locking <b>[7]</b>
PFH <sub>D</sub>		Depending on external control of guard locking <b>[8]</b>
<hr/>		
Mission time		20 y

**[1]** Screwed tight plug connector/mating component

**[2]** Preferably head downward

**[3]** Caution: outputs must be protected with a free-wheeling diode in case of inductive loads

**[4]** For alternatives see operating instructions

**[5]** Values at a switching current of 50mA without taking into account the cable lengths

**[6, 7, 8]** LEDs have the same ground potential as the guard locking solenoid.

## Dimension drawing

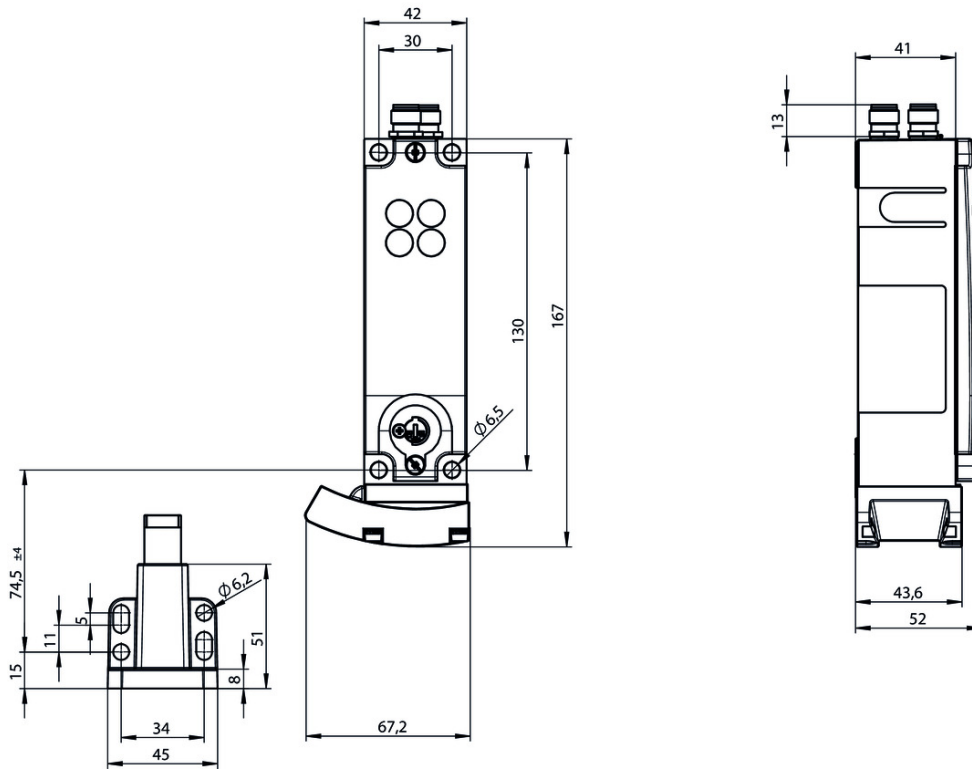
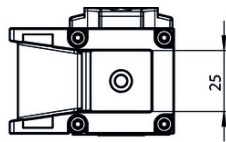

## Block diagram

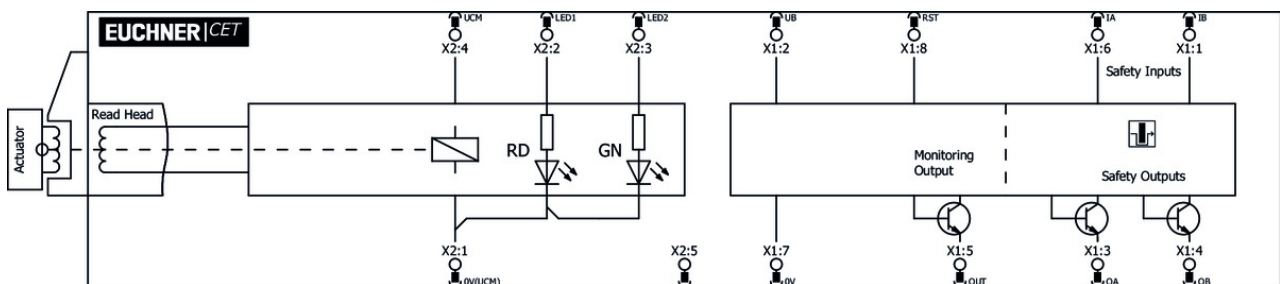

## Actuator

✓ Actuator CET-A-BWK-50X



**096327** CET-A-BWK-50X

✓ Features

- › Actuator for read head/safety switch CET
- › Four safety screws M5x16 included

## Connection material

---

- ✓ Connection cable with plug connector M12, 8-pin, 10m



**100178** C-M12F08-08X025PV10,0-MA-100178

✓ Features

- › M12 female plug, 8-pin
- › Straight plug connector
- › PVC cable
- › Cable length 10 m
- › With flying lead



**115113** C-M12F08-08X025PU10,0-MA-115113

✓ Features

- › M12 female plug, 8-pin
- › Straight plug connector
- › PUR cable
- › Cable length 10 m
- › With flying lead

- ✓ Connection cable with plug connector M12, 8-pin, 5m



**100177** C-M12F08-08X025PV05,0-MA-100177

✓ Features

- › M12 female plug, 8-pin
- › Straight plug connector
- › PVC cable
- › Cable length 5 m
- › With flying lead



**115112** C-M12F08-08X025PU05,0-MA-115112

✓ Features

- › M12 female plug, 8-pin
- › Straight plug connector
- › PUR cable
- › Cable length 5 m
- › With flying lead

- ✓ Connection cable with 2 plug connectors M12, 5-pin, 10m



**100181** C-M12F05-05X034PV10,0-M12M05-100181

✓ Features

- › M12 female plug to M12 plug connector, 5-pin
- › Straight female plug and plug connector
- › PVC cable
- › Cable length 10 m



**119947** C-M12F05-05X034PU10,0-M12M05-119947

✓ Features

- › M12 female plug to M12 plug connector, 5-pin
- › Straight female plug and plug connector

- › PUR cable
  - › Cable length 10 m
- 

▼ Connection cable with 2 plug connectors M12, 5-pin, 5m



**100180** C-M12F05-05X034PV05,0-M12M05-100180

▼ Features

- › M12 female plug to M12 plug connector, 5-pin
  - › Straight female plug and plug connector
  - › PVC cable
  - › Cable length 5 m
- 



**119932** C-M12F05-05X034PU05,0-M12M05-119932

▼ Features

- › M12 female plug to M12 plug connector, 5-pin
  - › Straight female plug and plug connector
  - › PUR cable
  - › Cable length 5 m
- 

▼ Connection cable with plug connector M12, 8-pin, 20m



**100179** C-M12F08-08X025PV20,0-MA-100179

▼ Features

- › M12 female plug, 8-pin
  - › Straight plug connector
  - › PVC cable
  - › Cable length 20 m
  - › With flying lead
- 



**115114** C-M12F08-08X025PU20,0-MA-115114

▼ Features

- › M12 female plug, 8-pin
  - › Straight plug connector
  - › PUR cable
  - › Cable length 20 m
  - › With flying lead
- 

▼ Connection cable with angled plug connector M12, 8-pin, 10m



**113188** C-M12F08-08X025PU10,0-MA-113188

▼ Features

- › M12 female plug, 8-pin
  - › Angled plug connector
  - › Cable outlet A (right)
  - › PUR cable
  - › Cable length 10 m
  - › With flying lead
- 



**113189** C-M12F08-08X025PU10,0-MA-113189

▼ Features

- › M12 female plug, 8-pin
- › Angled plug connector



- › Cable outlet C (left)
  - › PUR cable
  - › Cable length 10 m
  - › With flying lead
- 

▼ Connection cable with angled plug connector M12, 5-pin, 10m



**113187** C-M12F05-05X025PU10,0-MA-113187

▼ Features

- › M12 female plug, 5-pin
  - › Angled plug connector
  - › PUR cable
  - › Cable length 10 m
  - › Cable exit A (right)
  - › With flying lead
- 



**113190** C-M12F05-05X025PU10,0-MA-113190

▼ Features

- › M12 female plug, 5-pin
  - › Angled plug connector
  - › PUR cable
  - › Cable length 10 m
  - › Cable exit C (left)
  - › With flying lead
- 

▼ Connection cable with straight plug connector M12, 5-pin, 5m



**100183** C-M12F05-05X034PV05,0-MA-100183

▼ Features

- › M12 female plug, 5-pin
  - › Straight plug connector
  - › PVC cable
  - › Cable length 5 m
  - › With flying lead
- 



**113620** C-M12F05-05X034PU05,0-MA-113620

▼ Features

- › M12 female plug, 5-pin
  - › Straight plug connector
  - › PUR cable
  - › Cable length 5 m
  - › With flying lead
- 

▼ Connection cable with 2 plug connectors M12, 5-pin, 20m



**100182** C-M12F05-05X034PV20,0-M12M05-100182

▼ Features

- › M12 female plug to M12 plug connector, 5-pin
  - › Straight female plug and plug connector
  - › PVC cable
  - › Cable length 20 m
-



**119971** C-M12F05-05X034PU20,0-M12M05-119971

▼ Features

- › M12 female plug to M12 plug connector, 5-pin
  - › Straight female plug and plug connector
  - › PUR cable
  - › Cable length 20 m
- 

▼ Connection cable with plug connector M12, 5-pin, 10m



**100184** C-M12F05-05X034PV10,0-MA-100184

▼ Features

- › M12 female plug, 5-pin
  - › Straight plug connector
  - › PVC cable
  - › Cable length 10 m
  - › With flying lead
- 

▼ Connection cable with plug connector M12, 5-pin, 20m



**100185** C-M12F05-05X034PV20,0-MA-100185

▼ Features

- › M12 female plug, 5-pin
  - › Straight plug connector
  - › PVC cable
  - › Cable length 20 m
  - › With flying lead
- 

▼ Y-distributor M12 with connection cable



**111696** Y-VERTEILER M12 MIT ANSCHLUSSKABEL

▼ Features

- › Y-distributor M12 with connection cable, 2 x 5-pin, 1 x 8-pin
  - › Straight plug connector
  - › PVC cable
  - › Cable length 0.2 m
- 



**112395** Y-VERTEILER M12 MIT 1M KABEL

▼ Features

- › Y-distributor M12 with connection cable, 2 x 5-pin, 1 x 8-pin
  - › Straight plug connector
  - › PVC cable
  - › Cable length 1 m
- 

▼ Bridging plug M12



**097645** BRUECKEN-STECKER

▼ Features

- › Bridging plug
  - › M12 male plug, 4-pin
-

▼ Y-distributor M12



**097627** Y-VERTEILER M12

▼ Features

- › Y-distributor M12, 2 x 5-pin, 1 x 8-pin
- › Straight plug connector

▼ M12 extension PUR 5-pin, plug connectors at both ends, 10m



**115566** C-M12F05-05X025PU10,0-M12M05-115566

▼ Features

- › M12 female plug, 5-pin (angled) to M12 plug connector (straight)
- › Connectors at both ends
- › PUR cable
- › Cable length 10 m
- › With cable exit C (left)



**115565** C-M12F05-05X025PU10,0-M12M05-115565

▼ Features

- › M12 female plug, 5-pin (angled) to M12 plug connector (straight)
- › Connectors at both ends
- › PUR cable
- › Cable length 10 m
- › With cable exit A (right)

▼ Connection cable with plug connector M12, 8-pin, 30m



**115257** C-M12F08-08X025PU30,0-MA-115257

▼ Features

- › M12 female plug, 8-pin
- › Straight plug connector
- › PUR cable
- › Cable length 30 m
- › With flying lead



**115116** C-M12F08-08X025PV30,0-MA-115116

▼ Features

- › M12 female plug, 8-pin
- › Straight plug connector
- › PVC cable
- › Cable length 30 m
- › With flying lead

▼ Passive distribution module



**120861** AC-DP-04-SA-120861

▼ Features

- › Connection of up to 4 CES-AR, CET-AR, CTP-AR and ESL-AR
- › LEDs for the indication of the door position on each port
- › Can be connected in series

▼ Connection cable with angled plug connector M12, 8-pin, 20m



**120998** C-M12F08-08X025PU20,0-MA-120998

▼ Features

- › M12 female plug, 8-pin
  - › Angled plug connector
  - › Cable outlet A (right)
  - › PUR cable
  - › Cable length 20 m
  - › With flying lead
- 



**120999** C-M12F08-08X025PU20,0-MA-120999

▼ Features

- › M12 female plug, 8-pin
  - › Angled plug connector
  - › Cable outlet C (left)
  - › PUR cable
  - › Cable length 20 m
  - › With flying lead
- 

▼ Connection cable with straight plug connector M12, 5-pin, 30 m



**122784** C-M12F05-05X034PU30,0-MA-122784

▼ Features

- › M12 female plug, 5-pin
  - › Straight plug connector
  - › PUR cable
  - › Cable length 30 m
  - › With flying lead
- 

▼ Connection cable with straight plug connector M12, 5-pin, 20 m



**113682** C-M12F05-05X034PU20,0-MA-113682

▼ Features

- › M12 female plug, 5-pin
  - › Straight plug connector
  - › PUR cable
  - › Cable length 20 m
  - › With flying lead
- 

▼ Connection cable with straight plug connector M12, 5-pin, 10m



**113640** C-M12F05-05X034PU10,0-MA-113640

▼ Features

- › M12 female plug, 5-pin
  - › Straight plug connector
  - › PUR cable
  - › Cable length 10 m
  - › With flying lead
-

---

▼ Bolt CET-A-C



**104309** RIEGEL CET-A-C

▼ Features

- › Steel bolt
- › In combination with CET
- › For left or right hinged doors
- › Can be locked in open position with padlocks



**109672** RIEGEL CET-A-C-C2308

▼ Features

- › Steel bolt
- › In combination with CET
- › For left or right hinged doors
- › Can be locked in open position with padlocks
- › Bolt without door stop, suitable for swing doors

---

## Function expansion

▼ Double ramp for safety switch/read head CET



**114091** CET-DR

▼ Cover for read head and actuator CET



**098807** CET ABDECKUNG LINKS

▼ Features

- › Cover for read heads / safety switches CET and actuators CET
- › For approach direction C



**098808** CET ABDECKUNG RECHTS

▼ Features

- › Cover for read heads / safety switches CET and actuators CET
- › For approach direction A

▼ Emergency unlocking for CET



**103714** NOTENTSPERRUNG CET

▼ Mechanical key release for CET read head/switch



**098850** SCHLUESSEL-HILFSENTRIEGELUNG

▼ Features

- › Identical locking
- › Key removable in “unlocked” and “locked” positions

---

▼ Cover for actuator CET



### **124979** AM-C-124979

#### ✓ Features

- › Cover for actuator CET
  - › Horizontal and vertical fastening option on the actuator
  - › Mounting using 4 screws M5x16 (included with the actuator)
  - › Not suitable in combination with lockout bar for actuator CET
- 

### ✓ Lockout mechanism for CET actuator



### **122609** AE-L-CET-122609

#### ✓ Features

- › Prevents unintentional closing of the door
  - › Can be secured with padlocks
  - › Not suitable in combination with cover AM-C for actuator CET
- 



### **156429** AE-L-CET-156429

#### ✓ Features

- › Prevents unintentional closing of the door
  - › Can be secured with padlocks
- 

### ✓ Holder for lockout mechanism CET actuator



### **156338** Y-CHN-A1-156338

#### ✓ Features

- › Holder (incl. wire rope) for lockout bar CET
- 

### ✓ Lockout bar and holder for CET actuators



### **155865** AE-SET-LCHN-A1-155865

#### ✓ Features

- › Prevents unintentional closing of the door
  - › Can be secured with padlocks
- 

## Mounting accessories

---

### ✓ Mounting plate EMP-L-... for CET read head/switches



### **106695** EMP-L-CET

#### ✓ Features

- › Mounting plate for CET read heads/switches
  - › For hinged or sliding doors
  - › Suitable for aluminum profiles 40 ... 45 mm
  - › Horizontal and vertical mounting
  - › Suitable for CET with escape release
- 

### ✓ Mounting plate EM-P switch for safety switch CET

### **126399** AM-P-126399

#### ✓ Features



- › Mounting plate for CET read heads/switches
- › Direct mounting on aluminum profiles of width 30/40/50 mm
- › Suitable for the mounting plates AM-P-126400 and AM-P-126398

▼ Mounting plate EM-P actuator for safety switch CET



**126400** AM-P-126400

▼ Features

- › Mounting plate for CET actuator
- › Suitable for mounting on aluminum profiles of width 30/40/50 mm
- › Suitable for the mounting plates AM-P-126399 and AM-P-126398

▼ Mounting plate EM-P handle for safety switch CET



**126398** AM-P-126398

▼ Features

- › Mounting plate with handle (handle included)
- › For hinged or sliding doors
- › Horizontal and vertical assembly circuits possible
- › Suitable for aluminum profiles of width 30/40/50 mm
- › Suitable for the CET mounting plates AM-P-126399 and AM-P-126400

▼ Mounting plate EMP-B-... for actuator CET



**106694** EMP-B-CET

























▼ Features

- › Mounting plate for actuator CET for hinged or sliding doors
- › Suitable for aluminum profiles 40 ... 45 mm
- › Horizontal and vertical mounting
- › Made of aluminum

## Instructions



▼ Bezpečnostní informace CET (-AR/-AP)

	Doc. no.	Version	Language	Download
Sicherheitsinformation CET (-AR/-AP)	105517	14-01/17		0.7 MB
Información de seguridad CET (-AR/-AP)				
Information de sécurité CET (-AR/-AP)				
Informazioni sulla sicurezza CET (-AR/-AP)				
Safety Information CET (-AR/-AP)				
Bezpečnostní informace CET (-AR/-AP)	105517	14-01/17		0.2 MB
Informação de segurança CET (-AR/-AP)	105517	14-01/17		0.2 MB
Güvenlik bilgisi CET (-AR/-AP)	105517	14-01/17		0.3 MB
安全情報 CET (-AR/-AP)	105517	14-01/17		0.6 MB
Информация о безопасности CET (-AR/-AP)	105517	14-01/17		0.3 MB



安全信息 CET (-AR/-AP)	105517	14-01/17		 0.3 MB
<b>▼</b> Návod k použití Bezpečnostní spínač s kódovaným transpondérem a jištěním ochranného krytu CET.-AR-... (Unicode/Multicode)				
	<b>Doc. no.</b>	<b>Version</b>	<b>Language</b>	<b>Download</b>
Betriebsanleitung Transpondercodierter Sicherheitsschalter mit Zuhaltung CET.-AR-... (Uni-/Multicode)	2110788	12-07/18		 3.3 MB
Mode d'emploi Interrupteur de sécurité à codage par transpondeur avec interverrouillage CET.-AR-... (uni-/multicode)	2110788	12-07/18		 3.3 MB
Manual de instrucciones Interruptor de seguridad con codificación por transponder con bloqueo CET.-AR-... (Unicode/Multicode)	2110788	12-07/18		 3.3 MB
Návod k použití Bezpečnostní spínač s kódovaným transpondérem a jištěním ochranného krytu CET.-AR-... (Unicode/Multicode)	2110788	12-07/18		 3.6 MB
Operating Instructions Transponder-Coded Safety Switch With Guard Locking CET.-AR-... (Unicode/Multicode)	2110788	12-07/18		 3.3 MB
Istruzioni di impiego Finecorsa di sicurezza con codifica a transponder con meccanismo di ritenuta CET.-AR-... (Unicode/Multicode)	2110788	12-07/18		 3.3 MB
操作指示書トランスポンダー型コード化安全スイッチ CET.-AR-... (ユニコード/マルチコード)	2110788	12-07/18		 3.7 MB
Návod na prevádzku Bezpečnostný spínač kódovaný transpondérom s istením CET.-AR-... (Uni-/Multicode)	2110788	12-07/18		 3.5 MB
İşletim kılavuzu Kapalı tutmalı CET.-AR-... (Uni-/Multicode)	2110788	12-07/18		 3.7 MB
使用说明书应答机编码安全开关 CET.-AR-... (特殊/通用编码)	2110788	12-07/18		 3.7 MB
Инструкция по эксплуатации Транспондерный предохранительный выключатель с защитной блокировкой CET.-AR-... (Uni-/Multicode)	2110788	12-07/18		 3.8 MB

## Catalogs

- ▼** Transpondercodierte Sicherheitsschalter - Verriegelungseinrichtungen und Zuhaltungen  
 Transponder-coded safety switches - Interlocking devices and guard locking devices  
 Interruptores de seguridad con codificación por transponder - Dispositivos de enclavamiento y bloqueos  
 Interrupteurs de sécurité à codage par transpondeur - Dispositifs de verrouillage et interverrouillages







	<b>Doc. no.</b>	<b>Version</b>	<b>Language</b>	<b>Download</b>
Transpondercodierte Sicherheitsschalter - Verriegelungseinrichtungen und Zuhaltungen	127594	02-01/18		 5.2 MB
Interrupteurs de sécurité à codage par transpondeur - Dispositifs de verrouillage et interverrouillages	137558	02-01/18		 5.2 MB



Interrupedores de seguridad con codificación por transponder - Dispositivos de enclavamiento y bloqueos	137560	02-01/18		 5.2 MB
Transponder-coded safety switches - Interlocking devices and guard locking devices	127595	02-01/18		 5.1 MB

## Declaration of conformity

### EU-Konformitätserklärung

	Doc. no.	Version	Language	Download
EU-Konformitätserklärung	2110802	10-01/17		 0.3 MB
Declaración UE de conformidad				
Déclaration UE de conformité				
Dichiarazione di conformità				
EU declaration of conformity				

## CAD data

CAD data for this item on TraceParts