

ITEM 105764 CET1-AR-CRA-CH-50S-SG-105764

Description	Technical data	Accessories	Downloads
-------------	----------------	-------------	-----------



Features

- › Safety switch with guard locking and integrated evaluation electronics
- › Locking force up to 6500 N
- › Up to 20 switches in series
- › Short circuit monitoring
- › 2 safety outputs (semiconductor outputs)
- › Up to category 4/PL e according to EN ISO 13849-1
- › With 2 plug connectors M12
- › Multicode
- › Feedback loop
- › Approach direction A (default setting on delivery)

Approach direction

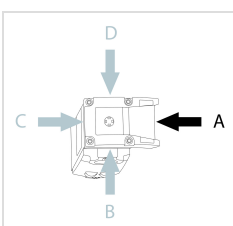

› Figure
Horizontal

Can be adjusted in 90° steps

Safety switch

The device may be operated only in conjunction with the actuator CET-A-....

Important: The actuator must be ordered separately.

Multicode evaluation unit

Every suitable actuator is detected by the switch.

Solenoid operating voltage

› DC 24 V +10% -15%

Guard locking type

CET1 Guard locking by spring force; release by applying voltage to the guard locking solenoid.

LED function display

LED State Status LED

LED DIA Diagnostic LED

LED 1 rd freely configurable

LED 2 gn freely configurable

Additional connections

OUT Monitoring output (semiconductor)

RST Reset input

Y Feedback loop

Category according to EN ISO 13849-1

Due to two redundantly designed semiconductor outputs (safety outputs) with internal monitoring suitable for:

› Category 4/PL e according to EN ISO 13849-1

Important: To achieve the stated category in accordance with EN ISO 13849-1, both safety outputs (OA and OB) must be evaluated.

The category is dependent on the installation position of the safety switch:

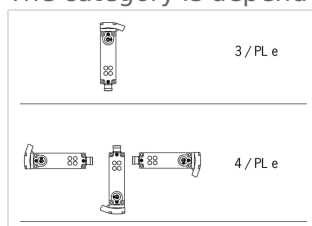

› Figure

Approvals

Mechanical values and environment

Housing material		
	Slide	Stainless steel
	Safety switch housing	Die-cast aluminum
Weight		
	Net	1 kg
Ambient temperature		
	At $U_B = 24V$ DC	-20 ... 55 °C
Degree of protection		IP67 [1]
Mechanical life		1×10^6
Installation position		Any [2]
Degree of freedom		
	X	± 5 mm
	Y	± 5 mm
	Z	± 4 mm
Ready delay		10 s
Switching frequency		max.0,5 Hz
Connection		2 plug connectors M12, 5 and 8-pin
Approach speed		20 m/min
Guard locking principle		Closed-circuit current principle
Locking force F_{max}		6500 N
Locking force F_{Zh}		5000 N

Electrical connection ratings

Operating voltage DC		
	U_B	24 V DC -15% ... 15% Reverse polarity protected, regulated, residual ripple < 5%, PELV
	LED1,LED2	24 V DC -15% ... 10%
Current consumption		
	I_B	80 mA
	I_{CM}	480 mA
Utilization category according to EN 60947-5-2		
	DC-13	24V 200mA [3]
Solenoid operating voltage DC		
	U_{CM}	24 V DC -15% ... +10% Reverse polarity protected, regulated, residual ripple < 5%, PELV
Fusing		
	External (operating voltage U_B)	0,25 ... 2 A
	External (operating voltage U_{CM})	0,5 ... 8 A
Power consumption		
	Solenoid	max.12 W

EMC protection requirements	In acc. with EN IEC 60947-5-3
Solenoid duty cycle	100 %
Degree of contamination (external, according to EN 60947-1)	3
Safety class	
EN IEC 61140	III
Switching load	
According to UL	24V DC, class 2 ^[4]
Safety outputs OA/OB	
Type of output	Semiconductor outputs, p-switching, short circuit-proof
Output voltage	
High U(OA,OB)	UB-1,5V ... UB V DC ^[5]
Low U(OA,OB)	0 ... 1 V DC
Output current	
per safety output	1 ... 200 mA
Off-state current I _r	max.0,25 mA
Risk time according to EN 60947-5-3	
Single device	max.400 ms
Delay per device	5 ms
Switch-on time	
Safety outputs	400 ms
Discrepancy time	
Both safety outputs	max.10 ms
Monitoring output OUT	
Type of output	Semiconductor output, p-switching, short circuit-proof
Output voltage	
OUT	0,8xUB ... UB V DC
Output current	
OUT	1 ... 50 mA
Feedback loop Y	
Input voltage	
High	15 ... 27,6 V DC
Low	0 ... 1 V DC

Operating distance

Repeat accuracy R	
According to EN 60947-5-2	10 %

Miscellaneous

For the approval according to UL the following applies	Operation only with UL class 2 power supply, or equivalent measures see operating instructions
--	--

Reliability values acc. to EN ISO 13849-1

		Monitoring of guard locking and the safety guard position
Category	Head upward	3
	Head downward or horizontal	4
Performance Level		PL e
PFH _D	Head upward	4.29×10^{-8}
	Head downward or horizontal	3.1×10^{-9}
		Control of the guard locking
Category		Depending on external control of guard locking [6]
Performance Level		Depending on external control of guard locking [7]
PFH _D		Depending on external control of guard locking [8]
Mission time		20 y

[1] Screwed tight plug connector/mating component

[2] Preferably head downward

[3] Caution: outputs must be protected with a free-wheeling diode in case of inductive loads

[4] For alternatives see operating instructions

[5] Values at a switching current of 50mA without taking into account the cable lengths

[6, 7, 8] Feedback loop and LEDs have the same ground potential as the guard locking solenoid

Dimension drawing

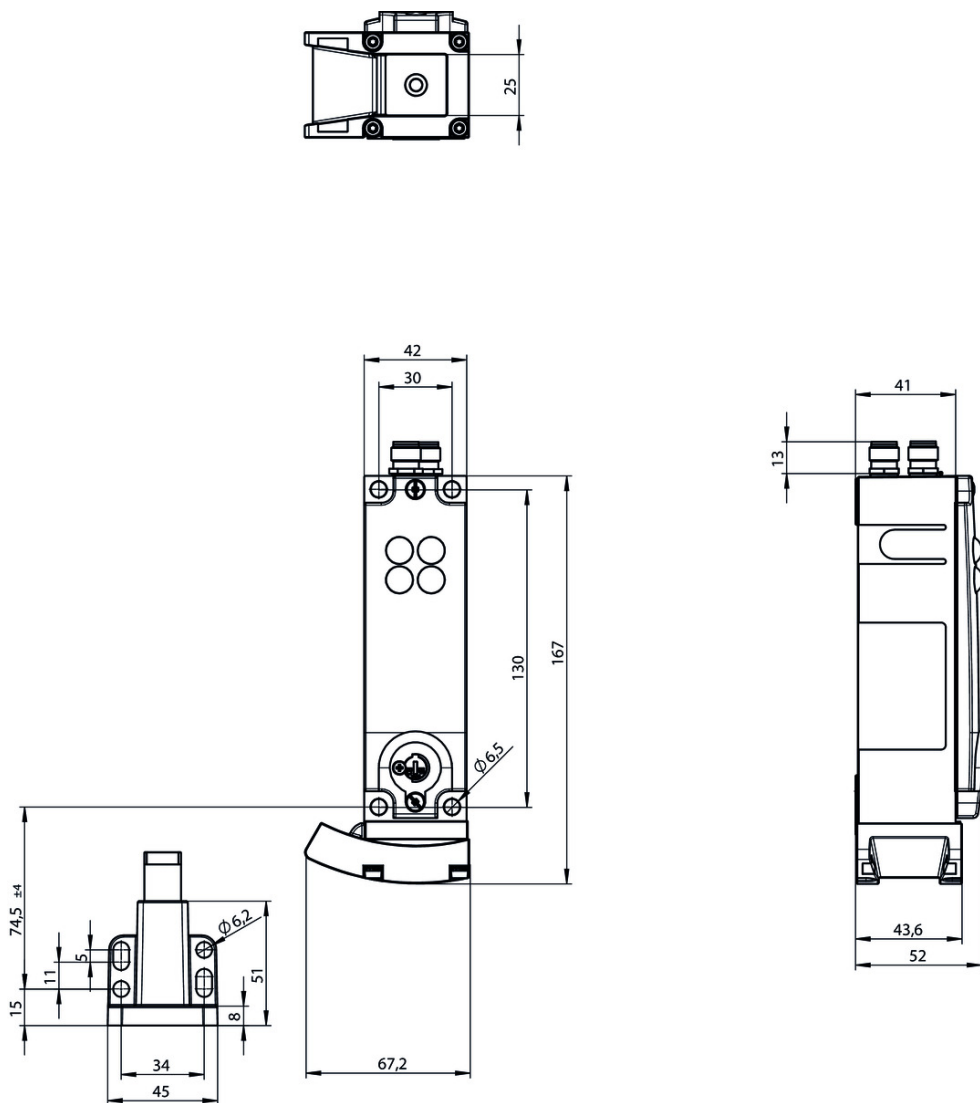

Block diagram

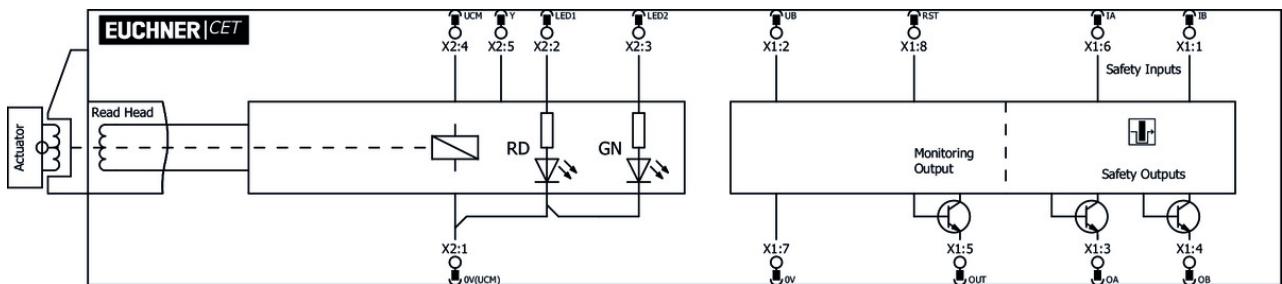

Connection material

- ✓ Connection cable with angled plug connector M12, 8-pin, 10m



113189 C-M12F08-08X025PU10,0-MA-113189

✓ Features

- › M12 female plug, 8-pin
- › Angled plug connector
- › Cable outlet C (left)

- › PUR cable
- › Cable length 10 m
- › With flying lead



113188 C-M12F08-08X025PU10,0-MA-113188

✓ Features

- › M12 female plug, 8-pin
- › Angled plug connector
- › Cable outlet A (right)
- › PUR cable
- › Cable length 10 m
- › With flying lead

✓ Bridging plug M12



097645 BRUECKEN-STECKER

✓ Features

- › Bridging plug
- › M12 male plug, 4-pin

✓ Y-distributor M12



097627 Y-VERTEILER M12

✓ Features

- › Y-distributor M12, 2 x 5-pin, 1 x 8-pin
- › Straight plug connector

✓ M12 extension PUR 5-pin, plug connectors at both ends, 10m



115565 C-M12F05-05X025PU10,0-M12M05-115565

✓ Features

- › M12 female plug, 5-pin (angled) to M12 plug connector (straight)
- › Connectors at both ends
- › PUR cable
- › Cable length 10 m
- › With cable exit A (right)



115566 C-M12F05-05X025PU10,0-M12M05-115566

✓ Features

- › M12 female plug, 5-pin (angled) to M12 plug connector (straight)
- › Connectors at both ends
- › PUR cable
- › Cable length 10 m
- › With cable exit C (left)

✓ Y-distributor M12 with connection cable



111696 Y-VERTEILER M12 MIT ANSCHLUSSKABEL

✓ Features

- › Y-distributor M12 with connection cable, 2 x 5-pin, 1 x 8-pin
- › Straight plug connector

- › PVC cable
- › Cable length 0.2 m



112395 Y-VERTEILER M12 MIT 1M KABEL

✓ Features

- › Y-distributor M12 with connection cable, 2 x 5-pin, 1 x 8-pin
- › Straight plug connector
- › PVC cable
- › Cable length 1 m

✓ Connection cable with angled plug connector M12, 5-pin, 10m



113190 C-M12F05-05X025PU10,0-MA-113190

✓ Features

- › M12 female plug, 5-pin
- › Angled plug connector
- › PUR cable
- › Cable length 10 m
- › Cable exit C (left)
- › With flying lead



113187 C-M12F05-05X025PU10,0-MA-113187

✓ Features

- › M12 female plug, 5-pin
- › Angled plug connector
- › PUR cable
- › Cable length 10 m
- › Cable exit A (right)
- › With flying lead

✓ Connection cable with 2 plug connectors M12, 5-pin, 20m



100182 C-M12F05-05X034PV20,0-M12M05-100182

✓ Features

- › M12 female plug to M12 plug connector, 5-pin
- › Straight female plug and plug connector
- › PVC cable
- › Cable length 20 m



119971 C-M12F05-05X034PU20,0-M12M05-119971

✓ Features

- › M12 female plug to M12 plug connector, 5-pin
- › Straight female plug and plug connector
- › PUR cable
- › Cable length 20 m

✓ Connection cable with 2 plug connectors M12, 5-pin, 10m



100181 C-M12F05-05X034PV10,0-M12M05-100181

✓ Features

- › M12 female plug to M12 plug connector, 5-pin
- › Straight female plug and plug connector

- › PVC cable
- › Cable length 10 m



119947 C-M12F05-05X034PU10,0-M12M05-119947

✓ Features

- › M12 female plug to M12 plug connector, 5-pin
- › Straight female plug and plug connector
- › PUR cable
- › Cable length 10 m

✓ Connection cable with straight plug connector M12, 5-pin, 5m



100183 C-M12F05-05X034PV05,0-MA-100183

✓ Features

- › M12 female plug, 5-pin
- › Straight plug connector
- › PVC cable
- › Cable length 5 m
- › With flying lead



113620 C-M12F05-05X034PU05,0-MA-113620

✓ Features

- › M12 female plug, 5-pin
- › Straight plug connector
- › PUR cable
- › Cable length 5 m
- › With flying lead

✓ Connection cable with plug connector M12, 5-pin, 10m



100184 C-M12F05-05X034PV10,0-MA-100184

✓ Features

- › M12 female plug, 5-pin
- › Straight plug connector
- › PVC cable
- › Cable length 10 m
- › With flying lead

✓ Connection cable with plug connector M12, 5-pin, 20m



100185 C-M12F05-05X034PV20,0-MA-100185

✓ Features

- › M12 female plug, 5-pin
- › Straight plug connector
- › PVC cable
- › Cable length 20 m
- › With flying lead

✓ Connection cable with plug connector M12, 8-pin, 5m

100177 C-M12F08-08X025PV05,0-MA-100177



- ✓ Features
 - › M12 female plug, 8-pin
 - › Straight plug connector
 - › PVC cable
 - › Cable length 5 m
 - › With flying lead
-



115112 C-M12F08-08X025PU05,0-MA-115112

- ✓ Features
 - › M12 female plug, 8-pin
 - › Straight plug connector
 - › PUR cable
 - › Cable length 5 m
 - › With flying lead
-

✓ Connection cable with plug connector M12, 8-pin, 10m



100178 C-M12F08-08X025PV10,0-MA-100178

- ✓ Features
 - › M12 female plug, 8-pin
 - › Straight plug connector
 - › PVC cable
 - › Cable length 10 m
 - › With flying lead
-



115113 C-M12F08-08X025PU10,0-MA-115113

- ✓ Features
 - › M12 female plug, 8-pin
 - › Straight plug connector
 - › PUR cable
 - › Cable length 10 m
 - › With flying lead
-

✓ Connection cable with plug connector M12, 8-pin, 20m



100179 C-M12F08-08X025PV20,0-MA-100179

- ✓ Features
 - › M12 female plug, 8-pin
 - › Straight plug connector
 - › PVC cable
 - › Cable length 20 m
 - › With flying lead
-



115114 C-M12F08-08X025PU20,0-MA-115114

- ✓ Features
 - › M12 female plug, 8-pin
 - › Straight plug connector
 - › PUR cable
 - › Cable length 20 m
 - › With flying lead
-

▼ Connection cable with 2 plug connectors M12, 5-pin, 5m



100180 C-M12F05-05X034PV05,0-M12M05-100180

▼ Features

- › M12 female plug to M12 plug connector, 5-pin
- › Straight female plug and plug connector
- › PVC cable
- › Cable length 5 m



119932 C-M12F05-05X034PU05,0-M12M05-119932

▼ Features

- › M12 female plug to M12 plug connector, 5-pin
- › Straight female plug and plug connector
- › PUR cable
- › Cable length 5 m

▼ Connection cable with plug connector M12, 8-pin, 30m



115257 C-M12F08-08X025PU30,0-MA-115257

▼ Features

- › M12 female plug, 8-pin
- › Straight plug connector
- › PUR cable
- › Cable length 30 m
- › With flying lead



115116 C-M12F08-08X025PV30,0-MA-115116

▼ Features

- › M12 female plug, 8-pin
- › Straight plug connector
- › PVC cable
- › Cable length 30 m
- › With flying lead

▼ Connection cable with angled plug connector M12, 8-pin, 20m



120998 C-M12F08-08X025PU20,0-MA-120998

▼ Features

- › M12 female plug, 8-pin
- › Angled plug connector
- › Cable outlet A (right)
- › PUR cable
- › Cable length 20 m
- › With flying lead



120999 C-M12F08-08X025PU20,0-MA-120999

▼ Features

- › M12 female plug, 8-pin
- › Angled plug connector
- › Cable outlet C (left)
- › PUR cable
- › Cable length 20 m
- › With flying lead

▼ Passive distribution module



120861 AC-DP-04-SA-120861

▼ Features

- › Connection of up to 4 CES-AR, CET-AR, CTP-AR and ESL-AR
 - › LEDs for the indication of the door position on each port
 - › Can be connected in series
-

▼ Connection cable with straight plug connector M12, 5-pin, 30 m



122784 C-M12F05-05X034PU30,0-MA-122784

▼ Features

- › M12 female plug, 5-pin
 - › Straight plug connector
 - › PUR cable
 - › Cable length 30 m
 - › With flying lead
-

▼ Connection cable with straight plug connector M12, 5-pin, 20 m



113682 C-M12F05-05X034PU20,0-MA-113682

▼ Features

- › M12 female plug, 5-pin
 - › Straight plug connector
 - › PUR cable
 - › Cable length 20 m
 - › With flying lead
-

▼ Connection cable with straight plug connector M12, 5-pin, 10m



113640 C-M12F05-05X034PU10,0-MA-113640

▼ Features

- › M12 female plug, 5-pin
 - › Straight plug connector
 - › PUR cable
 - › Cable length 10 m
 - › With flying lead
-

Function expansion

▼ Mechanical key release for CET read head/switch



098850 SCHLUESSEL-HILFSENTRIEGELUNG

▼ Features

- › Identical locking
 - › Key removable in “unlocked” and “locked” positions
-

▼ Emergency unlocking for CET



103714 NOTENTSPERRUNG CET

▼ Cover for read head and actuator CET



098808 CET ABDECKUNG RECHTS

▼ Features

- › Cover for read heads / safety switches CET and actuators CET
- › For approach direction A



098807 CET ABDECKUNG LINKS

▼ Features

- › Cover for read heads / safety switches CET and actuators CET
- › For approach direction C

▼ Double ramp for safety switch/read head CET



114091 CET-DR

▼ Cover for actuator CET



124979 AM-C-124979

▼ Features

- › Cover for actuator CET
- › Horizontal and vertical fastening option on the actuator
- › Mounting using 4 screws M5x16 (included with the actuator)
- › Not suitable in combination with lockout bar for actuator CET

▼ Lockout mechanism for CET actuator



122609 AE-L-CET-122609

▼ Features

- › Prevents unintentional closing of the door
- › Can be secured with padlocks
- › Not suitable in combination with cover AM-C for actuator CET



156429 AE-L-CET-156429

▼ Features

- › Prevents unintentional closing of the door
- › Can be secured with padlocks

▼ Holder for lockout mechanism CET actuator



156338 Y-CHN-A1-156338

▼ Features

- › Holder (incl. wire rope) for lockout bar CET

▼ Lockout bar and holder for CET actuators



155865 AE-SET-LCHN-A1-155865

▼ Features

- › Prevents unintentional closing of the door
 - › Can be secured with padlocks
-

Mounting accessories

▼ Mounting plate EMP-L-... for CET read head/switches



106695 EMP-L-CET

▼ Features

- › Mounting plate for CET read heads/switches
 - › For hinged or sliding doors
 - › Suitable for aluminum profiles 40 ... 45 mm
 - › Horizontal and vertical mounting
 - › Suitable for CET with escape release
-

▼ Mounting plate EM-P handle for safety switch CET



126398 AM-P-126398

▼ Features

- › Mounting plate with handle (handle included)
 - › For hinged or sliding doors
 - › Horizontal and vertical assembly circuits possible
 - › Suitable for aluminum profiles of width 30/40/50 mm
 - › Suitable for the CET mounting plates AM-P-126399 and AM-P-126400
-

▼ Mounting plate EM-P switch for safety switch CET



126399 AM-P-126399

▼ Features

- › Mounting plate for CET read heads/switches
 - › Direct mounting on aluminum profiles of width 30/40/50 mm
 - › Suitable for the mounting plates AM-P-126400 and AM-P-126398
-

▼ Mounting plate EM-P actuator for safety switch CET



126400 AM-P-126400

▼ Features

- › Mounting plate for CET actuator
 - › Suitable for mounting on aluminum profiles of width 30/40/50 mm
 - › Suitable for the mounting plates AM-P-126399 and AM-P-126398
-

▼ Mounting plate EMP-B-... for actuator CET



106694 EMP-B-CET

▼ Features

- › Mounting plate for actuator CET for hinged or sliding doors
- › Suitable for aluminum profiles 40 ... 45 mm
- › Horizontal and vertical mounting

- › Made of aluminum

Actuator

Actuator CET-A-BWK-50X



096327 CET-A-BWK-50X

Features

- › Actuator for read head/safety switch CET
- › Four safety screws M5x16 included

Bolt

Bolt CET-A-C



104309 RIEGEL CET-A-C

Features

- › Steel bolt
- › In combination with CET
- › For left or right hinged doors
- › Can be locked in open position with padlocks



109672 RIEGEL CET-A-C-C2308

Features

- › Steel bolt
- › In combination with CET
- › For left or right hinged doors
- › Can be locked in open position with padlocks
- › Bolt without door stop, suitable for swing doors

Instructions





Bezpečnostní informace CET (-AR/-AP)





	Doc. no.	Version	Language	Download
Sicherheitsinformation CET (-AR/-AP)	105517	14-01/17		0.7 MB
Información de seguridad CET (-AR/-AP)				
Information de sécurité CET (-AR/-AP)				
Informazioni sulla sicurezza CET (-AR/-AP)				
Safety Information CET (-AR/-AP)				
Bezpečnostní informace CET (-AR/-AP)	105517	14-01/17		0.2 MB
Informação de segurança CET (-AR/-AP)	105517	14-01/17		0.2 MB
Güvenlik bilgisi CET (-AR/-AP)	105517	14-01/17		0.3 MB
安全情報 CET (-AR/-AP)	105517	14-01/17		0.6 MB

Информация о безопасности CET (-AR/-AP)	105517	14-01/17		 0.3 MB
安全信息 CET (-AR/-AP)	105517	14-01/17		 0.3 MB
<input checked="" type="checkbox"/> Návod k použití Bezpečnostní spínač s kódovaným transpondérem a jištěním ochranného krytu CET.-AR-... (Unicode/Multicode)				
	Doc. no.	Version	Language	Download
Betriebsanleitung Transpondercodierter Sicherheitsschalter mit Zuhaltung CET.-AR-... (Uni-/Multicode)	2110788	12-07/18		 3.3 MB
Mode d'emploi Interrupteur de sécurité à codage par transpondeur avec interverrouillage CET.-AR-... (uni-/multicode)	2110788	12-07/18		 3.3 MB
Manual de instrucciones Interruptor de seguridad con codificación por transponder con bloqueo CET.-AR-... (Unicode/Multicode)	2110788	12-07/18		 3.3 MB
Návod k použití Bezpečnostní spínač s kódovaným transpondérem a jištěním ochranného krytu CET.-AR-... (Unicode/Multicode)	2110788	12-07/18		 3.6 MB
Operating Instructions Transponder-Coded Safety Switch With Guard Locking CET.-AR-... (Unicode/Multicode)	2110788	12-07/18		 3.3 MB
Istruzioni di impiego Finecorsa di sicurezza con codifica a transponder con meccanismo di ritenuta CET.-AR-... (Unicode/Multicode)	2110788	12-07/18		 3.3 MB
操作指示書トランスポンダー型コード化安全スイッチ CET.-AR-... (ユニコード/マルチコード)	2110788	12-07/18		 3.7 MB
Návod na prevádzku Bezpečnostný spínač kódovaný transpondérom s istením CET.-AR-... (Uni-/Multicode)	2110788	12-07/18		 3.5 MB
İşletim kılavuzu Kapalı tutmalı CET.-AR-... (Uni-/Multicode)	2110788	12-07/18		 3.7 MB
使用说明书应答机编码安全开关 CET.-AR-... (特殊/通用编码)	2110788	12-07/18		 3.7 MB
Инструкция по эксплуатации Транспондерный предохранительный выключатель с защитной блокировкой CET.-AR-... (Uni-/Multicode)	2110788	12-07/18		 3.8 MB

Catalogs







- Transpondercodierte Sicherheitsschalter - Verriegelungseinrichtungen und Zuhaltungen**
 Transponder-coded safety switches - Interlocking devices and guard locking devices
 Interruptores de seguridad con codificación por transponder - Dispositivos de enclavamiento y bloqueos
 Interrupteurs de sécurité à codage par transpondeur - Dispositifs de verrouillage et interverrouillages

	Doc. no.	Version	Language	Download
Transpondercodierte Sicherheitsschalter - Verriegelungseinrichtungen und Zuhaltungen	127594	02-01/18		 5.2 MB
Interrupteurs de sécurité à codage par transpondeur - Dispositifs de verrouillage et interverrouillages	137558	02-01/18		 5.2 MB

Interrupidores de seguridad con codificación por transponder - Dispositivos de enclavamiento y bloqueos	137560	02-01/18		 5.2 MB
Transponder-coded safety switches - Interlocking devices and guard locking devices	127595	02-01/18		 5.1 MB

Declaration of conformity

EU-Konformitätserklärung

	Doc. no.	Version	Language	Download
EU-Konformitätserklärung	2110802	10-01/17		 0.3 MB
Declaración UE de conformidad				
Déclaration UE de conformité				
Dichiarazione di conformità				
EU declaration of conformity				

CAD data

CAD data for this item on TraceParts