

ITEM 110082 CET2-AR-CRA-CH-50X-SG-110082

Description	Technical data	Accessories	Downloads
-------------	----------------	-------------	-----------



Features

- › Safety switch with guard locking and integrated evaluation electronics
- › Locking force up to 6500 N
- › Up to 20 switches in series
- › Short circuit monitoring
- › 2 safety outputs (semiconductor outputs)
- › Up to category 4/PL e according to EN ISO 13849-1
- › With 2 plug connectors M12
- › Multicode
- › Approach direction A (default setting on delivery)

Approach direction

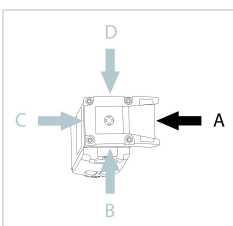

- › Figure
Horizontal
Can be adjusted in 90° steps

Safety switch

The device may be operated only in conjunction with the actuator CET-A-....

Important: The actuator must be ordered separately.

Multicode evaluation unit

Every suitable actuator is detected by the switch.

Solenoid operating voltage

› DC 24 V +10% -15%

Guard locking type

CET2 Open-circuit current principle guard locking by solenoid force.

Activation of the guard locking by applying voltage to the guard locking solenoid.

LED function display

LED State Status LED

LED DIA Diagnostic LED

LED 1 rd freely configurable

LED 2 gn freely configurable

Additional connections

OUT Monitoring output (semiconductor)

RST Reset input

Category according to EN ISO 13849-1

Due to two redundantly designed semiconductor outputs (safety outputs) with internal monitoring suitable for:

› Category 4/PL e according to EN ISO 13849-1

Important: To achieve the stated category in accordance with EN ISO 13849-1, both safety outputs (OA and OB) must be evaluated.

The category is dependent on the installation position of the safety switch:

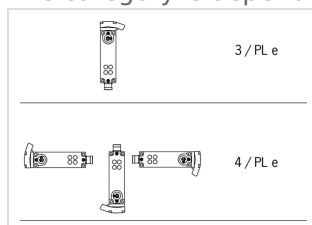

› Figure

Approvals

Mechanical values and environment

Housing material		
	Slide	Stainless steel
	Safety switch housing	Die-cast aluminum
Weight		
	Net	1 kg
Ambient temperature		
	At $U_B = 24V$ DC	-20 ... 55 °C
Degree of protection		IP67 [1]
Mechanical life		1×10^6
Installation position		Any [2]
Degree of freedom		
	X	± 5 mm
	Y	± 5 mm
	Z	± 4 mm
Ready delay		10 s
Switching frequency		max.0,5 Hz
Connection		2 plug connectors M12, 5 and 8-pin
Approach speed		20 m/min
Guard locking principle		Open-circuit current principle
Locking force F_{max}		6500 N
Locking force F_{Zh}		5000 N

Electrical connection ratings

Operating voltage DC		
	U_B	24 V DC -15% ... 15% Reverse polarity protected, regulated, residual ripple < 5%, PELV
	LED1 , LED2	24 V DC -15% ... 10%
Current consumption		
	I_B	80 mA
	I_{CM}	480 mA
Utilization category according to EN 60947-5-2		
	DC-13	24V 200mA [3]
Solenoid operating voltage DC		
	U_{CM}	24 V DC -15% ... +10% Reverse polarity protected, regulated, residual ripple < 5%, PELV
Fusing		
	External (operating voltage U_B)	0,25 ... 2 A
	External (operating voltage U_{CM})	0,5 ... 8 A
Power consumption		
	Solenoid	max.14 W

EMC protection requirements	In acc. with EN IEC 60947-5-3
Solenoid duty cycle	100 %
Degree of contamination (external, according to EN 60947-1)	3
Safety class	EN IEC 61140 III
Switching load	According to UL 24V DC, class 2 ^[4]
Safety outputs OA/OB	
Type of output	Semiconductor outputs, p-switching, short circuit-proof
Output voltage	High U(OA,OB) UB-1,5V ... UB V DC ^[5] Low U(OA,OB) 0 ... 1 V DC
Output current	per safety output 1 ... 200 mA
Off-state current I _r	max.0,25 mA
Risk time according to EN 60947-5-3	Single device max.400 ms Delay per device 5 ms
Switch-on time	Safety outputs 400 ms
Discrepancy time	Both safety outputs max.10 ms
Monitoring output OUT	
Type of output	Semiconductor output, p-switching, short circuit-proof
Output voltage	OUT 0,8xUB ... UB V DC
Output current	OUT 1 ... 50 mA

Operating distance

Repeat accuracy R	According to EN 60947-5-2 10 %
-------------------	--------------------------------

Miscellaneous

For the approval according to UL the following applies	Operation only with UL class 2 power supply, or equivalent measures see operating instructions
--	--

Reliability values acc. to EN ISO 13849-1

	Monitoring of guard locking and the safety guard position
Category	

	Head upward	3
	Head downward or horizontal	4
Performance Level		PL e
PFH _D	Head upward	4.29×10^{-8}
	Head downward or horizontal	3.1×10^{-9}
Mission time		20 y

- [1] Screwed tight plug connector/mating component
- [2] Preferably head downward
- [3] Caution: outputs must be protected with a free-wheeling diode in case of inductive loads
- [4] For alternatives see operating instructions
- [5] Values at a switching current of 50mA without taking into account the cable lengths

Dimension drawing

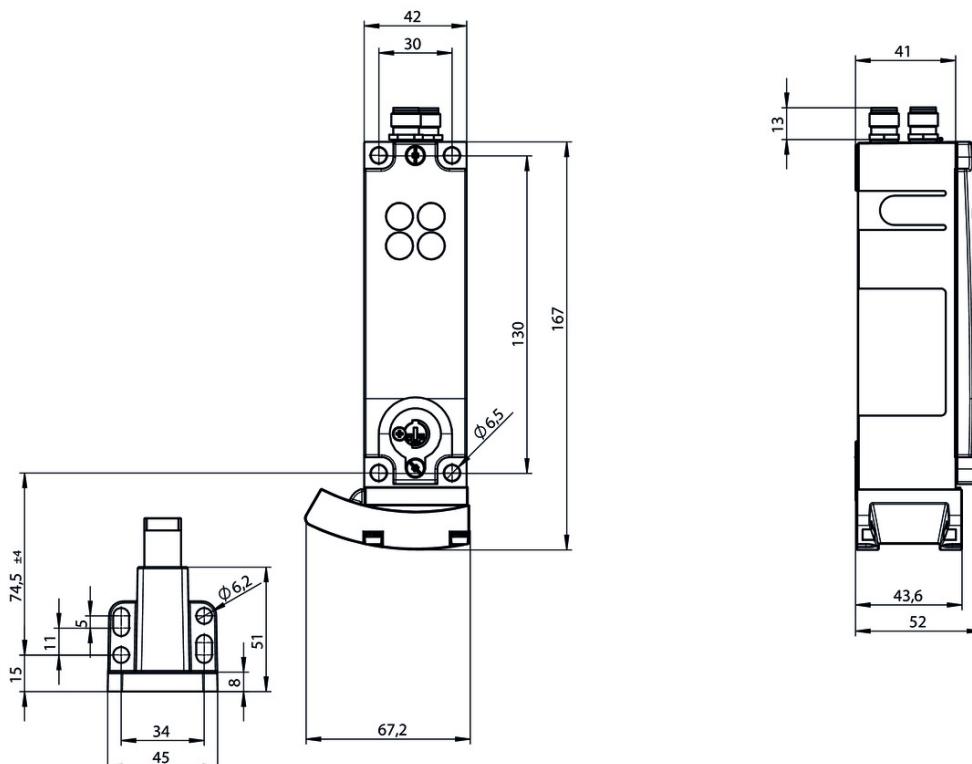
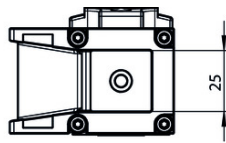

Block diagram

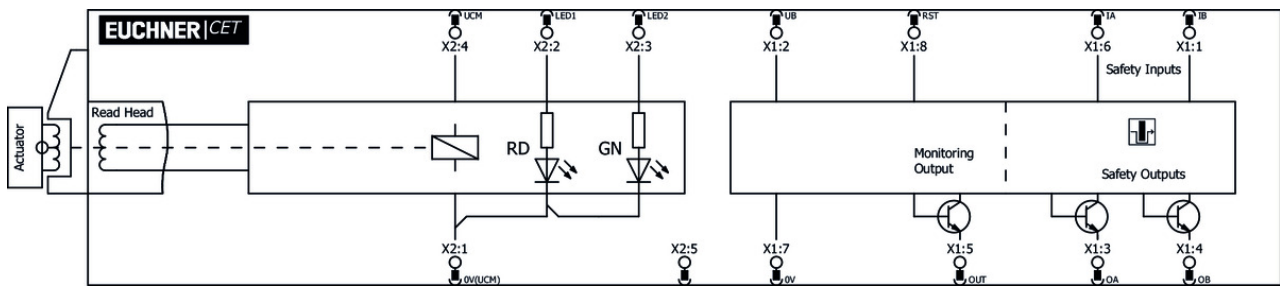

Actuator

Actuator CET-A-BWK-50X



096327 CET-A-BWK-50X

Features

- › Actuator for read head/safety switch CET
- › Four safety screws M5x16 included

Bolt

Bolt CET-A-C



104309 RIEGEL CET-A-C

Features

- › Steel bolt
- › In combination with CET
- › For left or right hinged doors
- › Can be locked in open position with padlocks



109672 RIEGEL CET-A-C-C2308

Features

- › Steel bolt
- › In combination with CET
- › For left or right hinged doors
- › Can be locked in open position with padlocks
- › Bolt without door stop, suitable for swing doors

Connection material

Connection cable with plug connector M12, 8-pin, 5m



100177 C-M12F08-08X025PV05,0-MA-100177

Features

- › M12 female plug, 8-pin
- › Straight plug connector
- › PVC cable
- › Cable length 5 m

- › With flying lead



115112 C-M12F08-08X025PU05,0-MA-115112

▼ Features

- › M12 female plug, 8-pin
- › Straight plug connector
- › PUR cable
- › Cable length 5 m
- › With flying lead

▼ Connection cable with plug connector M12, 8-pin, 10m



100178 C-M12F08-08X025PV10,0-MA-100178

▼ Features

- › M12 female plug, 8-pin
- › Straight plug connector
- › PVC cable
- › Cable length 10 m
- › With flying lead



115113 C-M12F08-08X025PU10,0-MA-115113

▼ Features

- › M12 female plug, 8-pin
- › Straight plug connector
- › PUR cable
- › Cable length 10 m
- › With flying lead

▼ Connection cable with plug connector M12, 8-pin, 20m



100179 C-M12F08-08X025PV20,0-MA-100179

▼ Features

- › M12 female plug, 8-pin
- › Straight plug connector
- › PVC cable
- › Cable length 20 m
- › With flying lead



115114 C-M12F08-08X025PU20,0-MA-115114

▼ Features

- › M12 female plug, 8-pin
- › Straight plug connector
- › PUR cable
- › Cable length 20 m
- › With flying lead

▼ Y-distributor M12



097627 Y-VERTEILER M12

▼ Features

- › Y-distributor M12, 2 x 5-pin, 1 x 8-pin
- › Straight plug connector

▼ Y-distributor M12 with connection cable



111696 Y-VERTEILER M12 MIT ANSCHLUSSKABEL

▼ Features

- › Y-distributor M12 with connection cable, 2 x 5-pin, 1 x 8-pin
- › Straight plug connector
- › PVC cable
- › Cable length 0.2 m



112395 Y-VERTEILER M12 MIT 1M KABEL

▼ Features

- › Y-distributor M12 with connection cable, 2 x 5-pin, 1 x 8-pin
- › Straight plug connector
- › PVC cable
- › Cable length 1 m

▼ Bridging plug M12



097645 BRUECKEN-STECKER

▼ Features

- › Bridging plug
- › M12 male plug, 4-pin

▼ M12 extension PUR 5-pin, plug connectors at both ends, 10m



115566 C-M12F05-05X025PU10,0-M12M05-115566

▼ Features

- › M12 female plug, 5-pin (angled) to M12 plug connector (straight)
- › Connectors at both ends
- › PUR cable
- › Cable length 10 m
- › With cable exit C (left)



115565 C-M12F05-05X025PU10,0-M12M05-115565

▼ Features

- › M12 female plug, 5-pin (angled) to M12 plug connector (straight)
- › Connectors at both ends
- › PUR cable
- › Cable length 10 m
- › With cable exit A (right)

▼ Connection cable with angled plug connector M12, 5-pin, 10m



113190 C-M12F05-05X025PU10,0-MA-113190

▼ Features

- › M12 female plug, 5-pin
- › Angled plug connector
- › PUR cable
- › Cable length 10 m
- › Cable exit C (left)

- › With flying lead



113187 C-M12F05-05X025PU10,0-MA-113187

▣ Features

- › M12 female plug, 5-pin
- › Angled plug connector
- › PUR cable
- › Cable length 10 m
- › Cable exit A (right)
- › With flying lead

- ▣ Connection cable with angled plug connector M12, 8-pin, 10m



113189 C-M12F08-08X025PU10,0-MA-113189

▣ Features

- › M12 female plug, 8-pin
- › Angled plug connector
- › Cable outlet C (left)
- › PUR cable
- › Cable length 10 m
- › With flying lead



113188 C-M12F08-08X025PU10,0-MA-113188

▣ Features

- › M12 female plug, 8-pin
- › Angled plug connector
- › Cable outlet A (right)
- › PUR cable
- › Cable length 10 m
- › With flying lead

- ▣ Connection cable with plug connector M12, 5-pin, 20m



100185 C-M12F05-05X034PV20,0-MA-100185

▣ Features

- › M12 female plug, 5-pin
- › Straight plug connector
- › PVC cable
- › Cable length 20 m
- › With flying lead

- ▣ Connection cable with 2 plug connectors M12, 5-pin, 10m



100181 C-M12F05-05X034PV10,0-M12M05-100181

▣ Features

- › M12 female plug to M12 plug connector, 5-pin
- › Straight female plug and plug connector
- › PVC cable
- › Cable length 10 m



119947 C-M12F05-05X034PU10,0-M12M05-119947

▣ Features

- › M12 female plug to M12 plug connector, 5-pin
 - › Straight female plug and plug connector
 - › PUR cable
 - › Cable length 10 m
-

▼ Connection cable with 2 plug connectors M12, 5-pin, 5m



100180 C-M12F05-05X034PV05,0-M12M05-100180

▼ Features

- › M12 female plug to M12 plug connector, 5-pin
 - › Straight female plug and plug connector
 - › PVC cable
 - › Cable length 5 m
-



119932 C-M12F05-05X034PU05,0-M12M05-119932

▼ Features

- › M12 female plug to M12 plug connector, 5-pin
 - › Straight female plug and plug connector
 - › PUR cable
 - › Cable length 5 m
-

▼ Connection cable with 2 plug connectors M12, 5-pin, 20m



100182 C-M12F05-05X034PV20,0-M12M05-100182

▼ Features

- › M12 female plug to M12 plug connector, 5-pin
 - › Straight female plug and plug connector
 - › PVC cable
 - › Cable length 20 m
-



119971 C-M12F05-05X034PU20,0-M12M05-119971

▼ Features

- › M12 female plug to M12 plug connector, 5-pin
 - › Straight female plug and plug connector
 - › PUR cable
 - › Cable length 20 m
-

▼ Connection cable with straight plug connector M12, 5-pin, 5m



100183 C-M12F05-05X034PV05,0-MA-100183

▼ Features

- › M12 female plug, 5-pin
 - › Straight plug connector
 - › PVC cable
 - › Cable length 5 m
 - › With flying lead
-



113620 C-M12F05-05X034PU05,0-MA-113620

▼ Features

- › M12 female plug, 5-pin
- › Straight plug connector
- › PUR cable

- › Cable length 5 m
 - › With flying lead
-

▼ Connection cable with plug connector M12, 5-pin, 10m



100184 C-M12F05-05X034PV10,0-MA-100184

▼ Features

- › M12 female plug, 5-pin
 - › Straight plug connector
 - › PVC cable
 - › Cable length 10 m
 - › With flying lead
-

▼ Connection cable with plug connector M12, 8-pin, 30m



115257 C-M12F08-08X025PU30,0-MA-115257

▼ Features

- › M12 female plug, 8-pin
 - › Straight plug connector
 - › PUR cable
 - › Cable length 30 m
 - › With flying lead
-



115116 C-M12F08-08X025PV30,0-MA-115116

▼ Features

- › M12 female plug, 8-pin
 - › Straight plug connector
 - › PVC cable
 - › Cable length 30 m
 - › With flying lead
-

▼ Connection cable with angled plug connector M12, 8-pin, 20m



120998 C-M12F08-08X025PU20,0-MA-120998

▼ Features

- › M12 female plug, 8-pin
 - › Angled plug connector
 - › Cable outlet A (right)
 - › PUR cable
 - › Cable length 20 m
 - › With flying lead
-



120999 C-M12F08-08X025PU20,0-MA-120999

▼ Features

- › M12 female plug, 8-pin
 - › Angled plug connector
 - › Cable outlet C (left)
 - › PUR cable
 - › Cable length 20 m
 - › With flying lead
-

▼ Passive distribution module



120861 AC-DP-04-SA-120861

▼ Features

- › Connection of up to 4 CES-AR, CET-AR, CTP-AR and ESL-AR
- › LEDs for the indication of the door position on each port
- › Can be connected in series

▼ Connection cable with straight plug connector M12, 5-pin, 30 m



122784 C-M12F05-05X034PU30,0-MA-122784

▼ Features

- › M12 female plug, 5-pin
- › Straight plug connector
- › PUR cable
- › Cable length 30 m
- › With flying lead

▼ Connection cable with straight plug connector M12, 5-pin, 20 m



113682 C-M12F05-05X034PU20,0-MA-113682

▼ Features

- › M12 female plug, 5-pin
- › Straight plug connector
- › PUR cable
- › Cable length 20 m
- › With flying lead

▼ Connection cable with straight plug connector M12, 5-pin, 10m



113640 C-M12F05-05X034PU10,0-MA-113640

▼ Features

- › M12 female plug, 5-pin
- › Straight plug connector
- › PUR cable
- › Cable length 10 m
- › With flying lead

Function expansion

▼ Emergency unlocking for CET



103714 NOTENTSPERRUNG CET

▼ Mechanical key release for CET read head/switch



098850 SCHLUESSEL-HILFSENTRIEGELUNG

▼ Features

- › Identical locking
- › Key removable in “unlocked” and “locked” positions

▼ Cover for read head and actuator CET



098808 CET ABDECKUNG RECHTS

▼ Features

- › Cover for read heads / safety switches CET and actuators CET
- › For approach direction A



098807 CET ABDECKUNG LINKS

▼ Features

- › Cover for read heads / safety switches CET and actuators CET
- › For approach direction C

▼ Double ramp for safety switch/read head CET



114091 CET-DR

▼ Cover for actuator CET



124979 AM-C-124979

▼ Features

- › Cover for actuator CET
- › Horizontal and vertical fastening option on the actuator
- › Mounting using 4 screws M5x16 (included with the actuator)
- › Not suitable in combination with lockout bar for actuator CET

▼ Lockout mechanism for CET actuator



122609 AE-L-CET-122609

▼ Features

- › Prevents unintentional closing of the door
- › Can be secured with padlocks
- › Not suitable in combination with cover AM-C for actuator CET



156429 AE-L-CET-156429

▼ Features

- › Prevents unintentional closing of the door
- › Can be secured with padlocks

▼ Holder for lockout mechanism CET actuator



156338 Y-CHN-A1-156338

▼ Features

- › Holder (incl. wire rope) for lockout bar CET

▼ Lockout bar and holder for CET actuators

155865 AE-SET-LCHN-A1-155865



▼ Features

- › Prevents unintentional closing of the door
 - › Can be secured with padlocks
-

Mounting accessories

▼ Mounting plate EMP-L-... for CET read head/switches



106695 EMP-L-CET

▼ Features

- › Mounting plate for CET read heads/switches
 - › For hinged or sliding doors
 - › Suitable for aluminum profiles 40 ... 45 mm
 - › Horizontal and vertical mounting
 - › Suitable for CET with escape release
-

▼ Mounting plate EM-P switch for safety switch CET



126399 AM-P-126399

▼ Features

- › Mounting plate for CET read heads/switches
 - › Direct mounting on aluminum profiles of width 30/40/50 mm
 - › Suitable for the mounting plates AM-P-126400 and AM-P-126398
-

▼ Mounting plate EM-P actuator for safety switch CET



126400 AM-P-126400

▼ Features

- › Mounting plate for CET actuator
 - › Suitable for mounting on aluminum profiles of width 30/40/50 mm
 - › Suitable for the mounting plates AM-P-126399 and AM-P-126398
-

▼ Mounting plate EM-P handle for safety switch CET



126398 AM-P-126398

▼ Features

- › Mounting plate with handle (handle included)
 - › For hinged or sliding doors
 - › Horizontal and vertical assembly circuits possible
 - › Suitable for aluminum profiles of width 30/40/50 mm
 - › Suitable for the CET mounting plates AM-P-126399 and AM-P-126400
-

▼ Mounting plate EMP-B-... for actuator CET





















106694 EMP-B-CET

▼ Features



















- › Mounting plate for actuator CET for hinged or sliding doors
- › Suitable for aluminum profiles 40 ... 45 mm
- › Horizontal and vertical mounting
- › Made of aluminum

Instructions

☑ Bezpečnostní informace CET (-AR/-AP)

	Doc. no.	Version	Language	Download
Sicherheitsinformation CET (-AR/-AP)	105517	14-01/17		 0.7 MB
Información de seguridad CET (-AR/-AP)				
Information de sécurité CET (-AR/-AP)				
Informazioni sulla sicurezza CET (-AR/-AP)				
Safety Information CET (-AR/-AP)				
Bezpečnostní informace CET (-AR/-AP)	105517	14-01/17		 0.2 MB
Informação de segurança CET (-AR/-AP)	105517	14-01/17		 0.2 MB
Güvenlik bilgisi CET (-AR/-AP)	105517	14-01/17		 0.3 MB
安全情報 CET (-AR/-AP)	105517	14-01/17		 0.6 MB
Информация о безопасности CET (-AR/-AP)	105517	14-01/17		 0.3 MB
安全信息 CET (-AR/-AP)	105517	14-01/17		 0.3 MB









☑ Návod k použití Bezpečnostní spínač s kódovaným transpondérem a jištěním ochranného krytu CET.-AR-... (Unicode/Multicode)

	Doc. no.	Version	Language	Download
Betriebsanleitung Transpondercodierter Sicherheitsschalter mit Zuhaltung CET.-AR-... (Uni-/Multicode)	2110788	12-07/18		 3.3 MB
Mode d'emploi Interrupteur de sécurité à codage par transpondeur avec interverrouillage CET.-AR-... (uni-/multicode)	2110788	12-07/18		 3.3 MB
Manual de instrucciones Interruptor de seguridad con codificación por transponder con bloqueo CET.-AR-... (Unicode/Multicode)	2110788	12-07/18		 3.3 MB
Návod k použití Bezpečnostní spínač s kódovaným transpondérem a jištěním ochranného krytu CET.-AR-... (Unicode/Multicode)	2110788	12-07/18		 3.6 MB
Operating Instructions Transponder-Coded Safety Switch With Guard Locking CET.-AR-... (Unicode/Multicode)	2110788	12-07/18		 3.3 MB
Istruzioni di impiego Finecorsa di sicurezza con codifica a transponder con meccanismo di ritenuta CET.-AR-... (Unicode/Multicode)	2110788	12-07/18		 3.3 MB
操作指示書トランスポンダー型コード化安全スイッチ CET.-AR-... (ユニコード/マルチコード)	2110788	12-07/18		 3.7 MB
Návod na prevádzku Bezpečnostný spínač kódovaný transpondérom s istením CET.-AR-... (Uni-/Multicode)	2110788	12-07/18		 3.5 MB
İşletim kılavuzu Kapalı tutmalı CET.-AR-... (Uni-/Multicode)	2110788	12-07/18		 3.7 MB

使用说明书应答机编码安全开关 CET.-AR-... (特殊/通用编码)	2110788	12-07/18		 3.7 MB
Инструкция по эксплуатации Транспондерный предохранительный выключатель с защитной блокировкой CET.-AR-... (Uni-/Multicode)	2110788	12-07/18		 3.8 MB





Catalogs

-  Transpondercodierte Sicherheitsschalter - Verriegelungseinrichtungen und Zuhaltungen
 Transponder-coded safety switches - Interlocking devices and guard locking devices
 Interruptores de seguridad con codificación por transponder - Dispositivos de enclavamiento y bloqueos
 Interrupteurs de sécurité à codage par transpondeur - Dispositifs de verrouillage et interverrouillages

	Doc. no.	Version	Language	Download
Transpondercodierte Sicherheitsschalter - Verriegelungseinrichtungen und Zuhaltungen	127594	02-01/18		 5.2 MB
Interrupteurs de sécurité à codage par transpondeur - Dispositifs de verrouillage et interverrouillages	137558	02-01/18		 5.2 MB
Interruptores de seguridad con codificación por transponder - Dispositivos de enclavamiento y bloqueos	137560	02-01/18		 5.2 MB
Transponder-coded safety switches - Interlocking devices and guard locking devices	127595	02-01/18		 5.1 MB

Declaration of conformity

-  EU-Konformitätserklärung

	Doc. no.	Version	Language	Download
EU-Konformitätserklärung Declaración UE de conformidad Déclaration UE de conformité Dichiarazione di conformità EU declaration of conformity	2110802	10-01/17	    	 0.3 MB

CAD data

CAD data for this item on TraceParts