

ITEM 110905 CET3-AR-CRA-CH-50F-SG-C2290-110905

Description	Technical data	Accessories	Downloads
-------------	----------------	-------------	-----------



### Features

- › Safety switch with guard locking and integrated evaluation electronics
- › Locking force up to 6500 N
- › Up to 20 switches in series
- › Short circuit monitoring
- › 2 safety outputs (semiconductor outputs)
- › Up to category 4/PL e according to EN ISO 13849-1
- › With 2 plug connectors M12
- › Multicode
- › Door monitoring output
- › Indication of the door position by LED
- › Wire front release (bowden), 3 m, automatic return
- › With escape release, 75 mm long
- › Approach direction A (default setting on delivery)

### Approach direction

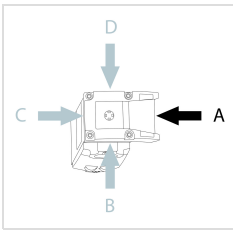

► Figure

Horizontal

Can be adjusted in 90° steps

---

### Safety switch

The device may be operated only in conjunction with the actuator CET-A-....

**Important:** The actuator must be ordered separately.

---

### Multicode evaluation unit

Every suitable actuator is detected by the switch.

---

### Solenoid operating voltage

► DC 24 V +10% -15%

---

### Guard locking type

**CET3 Closed-circuit current principle**, guard locking by spring force.

Release by applying voltage to the guard locking solenoid. The door position is also monitored. The door monitoring output OUT D is set to HIGH as soon as the actuator is above the extended plunger (state: door closed, guard locking not active). The output OUT D remains set also with guard locking active.

---

### LED function display

**LED State** Status LED

**LED DIA** Diagnostic LED

**LED 1 rd** freely configurable

**LED 2 gn** illuminates when door is closed

---

### Additional connections

**OUT** Monitoring output (semiconductor)

**OUT D** Door monitoring output

**RST** Reset input

---

### Category according to EN ISO 13849-1

Due to two redundantly designed semiconductor outputs (safety outputs) with internal monitoring suitable for:

► Category 4/PL e according to EN ISO 13849-1

**Important:** To achieve the stated category in accordance with EN ISO 13849-1, both safety outputs (OA and OB) must be evaluated.

The category is dependent on the installation position of the safety switch:

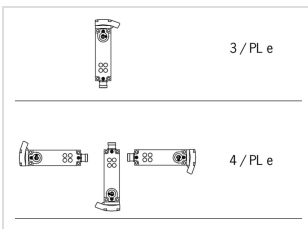

➤ Figure

### Wire front release (bowden)

The wire front release permits remote unlocking of the guard locking via a pull wire. Flexible routing of the pull wire permits release of the guard locking in inaccessible installation situations.

**Important:** The wire front release (bowden) is not a safety function.

### Escape release

This is used for manual release of guard locking from the danger zone without tools.

### Approvals



### Mechanical values and environment

Housing material		
	Slide	Stainless steel
	Safety switch housing	Die-cast aluminum
Weight		
	Net	1 kg
Ambient temperature		
	At $U_B = 24V DC$	-20 ... 55 °C
Degree of protection		IP67 [1]
Resilience to vibration		In acc. with EN IEC 60947-5-2
Mechanical life		$1 \times 10^6$
Installation position		Any [2]
Degree of freedom		
	X	±5 mm
	Y	±5 mm
	Z	±4 mm
Ready delay		10 s
Switching frequency		max.0,5 Hz
Connection		2 plug connectors M12, 5 and 8-pin
Approach speed		20 m/min
Guard locking principle		Closed-circuit current principle

Locking force $F_{\max}$	6500 N
Locking force $F_{Zh}$	5000 N [3]

## Electrical connection ratings

Operating voltage DC	$U_B$	24 V DC -15% ... 15% Reverse polarity protected, regulated, residual ripple < 5%, PELV
	LED	24 V DC -15% ... 10%
Current consumption	$I_B$	80 mA
	$I_{CM}$	480 mA
Utilization category according to EN 60947-5-2	DC-13	24V 200mA [4]
Solenoid operating voltage DC	$U_{CM}$	24 V DC -15% ... +10% Reverse polarity protected, regulated, residual ripple < 5%, PELV
Fusing	External (operating voltage $U_B$ )	0,25 ... 2 A
	External (solenoid operating voltage $U_{CM}$ )	0,5 ... 8 A
Power consumption	Solenoid	max.12 W
EMC protection requirements		In acc. with EN IEC 60947-5-3
Solenoid duty cycle		100 %
Degree of contamination (external, according to EN 60947-1)		3
Connecting cable		30V DC, 2A [5]
Safety class	EN IEC 61140	III
Switching load	According to UL	24V DC, class 2 [6]
<b>Safety outputs OA/OB</b>		
Type of output		2 semiconductor outputs, p-switching, short circuit-proof
Switching current	Per safety output OA / OB	1 ... 200 mA
Output voltage	High $U(OA) / U(OB)$	$U_B - 1,5V \dots U_B$ V DC
	Low $U(OA) / U(OB)$	0 ... 1 V DC
Off-state current $I_r$		max.0,25 mA
Risk time according to EN 60947-5-3	Single device	max.400 ms
	Delay per device	5 ms
Switch-on time		400 ms
Discrepancy time	Both safety outputs	max.10 ms

		<b>Monitoring output OUT</b>
Type of output		p-switching, short circuit-proof
Switching current	OUT	1 ... 50 mA
Output voltage	OUT	0,8xUB ... UB V DC
Switching delay from state change		max.400 ms
		<b>Monitoring output OUT D</b>
Type of output		p-switching, short circuit-proof
Switching current	OUT D	1 ... 50 mA
Output voltage	OUT D	0,8xUB ... UB V DC
Switching delay from state change		max.700 ms

### Operating distance

Repeat accuracy R According to EN 60947-5-2	10 %
--	------

### Miscellaneous

C number C2290	With wire front release (bowden) mounted
For the approval according to UL the following applies	Operation only with UL class 2 power supply, or equivalent measures see operating instructions

### Reliability values acc. to EN ISO 13849-1

		<b>Monitoring of guard locking and the safety guard position</b>
Category	Head upward	3
	Head downward or horizontal	4
Performance Level		PL e
PFH <sub>D</sub>	Head upward	$4.29 \times 10^{-8}$
	Head downward or horizontal	$3.1 \times 10^{-9}$
		<b>Control of the guard locking</b>
Category		Depending on external control of guard locking [7]
Performance Level		Depending on external control of guard locking [8]
PFH <sub>D</sub>		Depending on external control of guard locking [9]
Mission time		20 y

- [1] Screwed tight plug connector/mating component
- [2] Preferably head downward
- [3]  $FZH = FMAX/1.3$
- [4] Caution: outputs must be protected with a free-wheeling diode in case of inductive loads
- [5] For UL requirement UL category code (CYJV/CYJV7)
- [6] For alternatives see operating instructions
- [7, 8, 9] LEDs have the same ground potential as the guard locking solenoid.

### Dimension drawing

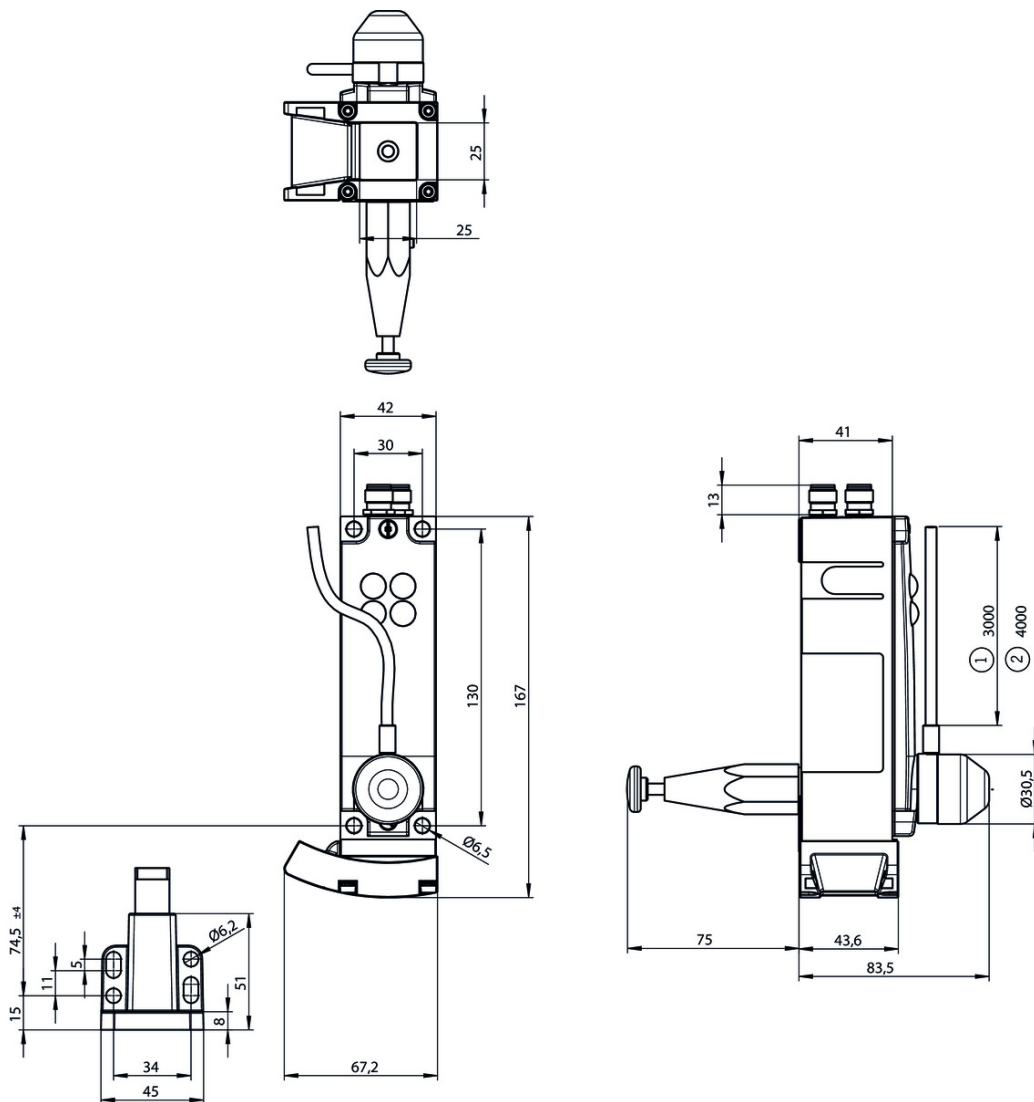

### Legende

- 1 Hose length
- 2 Rope length

## Block diagram

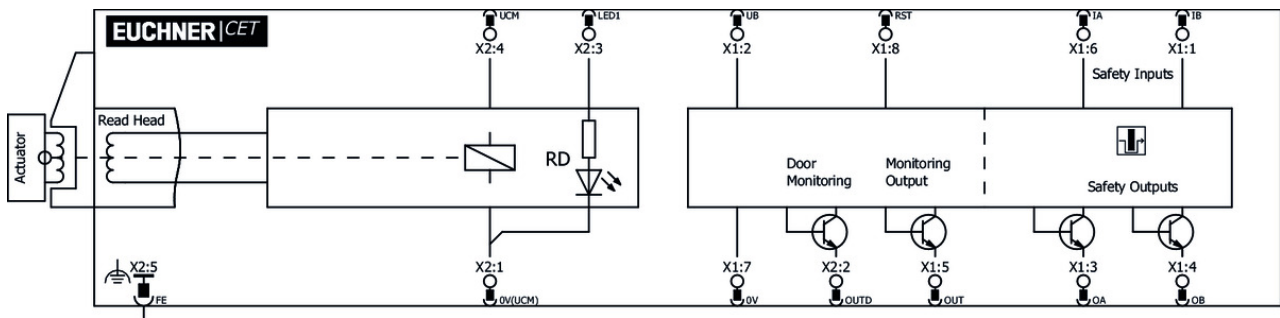

## Actuator

### Actuator CET-A-BWK-50X



#### 096327 CET-A-BWK-50X

##### Features

- › Actuator for read head/safety switch CET
- › Four safety screws M5x16 included

## Bolt

### Bolt CET-A-C/F with escape release



#### 106172 RIEGEL CET-A-C/F

##### Features

- › Steel bolt
- › For doors hinged on the left or right
- › In combination with CET with escape release
- › Detent knob in open position
- › Can be locked in open position with padlocks



#### 106350 RIEGEL CET-A-C/F-C2282

##### Features

- › Steel bolt
- › Stainless steel guide strip
- › For left or right hinged doors
- › In combination with CET with escape release
- › Detent knob in open position
- › Can be locked in open position with padlocks

## Function expansion

### Cover for read head and actuator CET



#### 098808 CET ABDECKUNG RECHTS

##### Features

- › Cover for read heads / safety switches CET and actuators CET

- › For approach direction A



**098807** CET ABDECKUNG LINKS

✓ Features

- › Cover for read heads / safety switches CET and actuators CET
- › For approach direction C

✓ Handle for wire front release



**124204** AY-HDL-124204

✓ Features

- › Suitable for all wire front releases



**099795** AY-HDL-099795

✓ Features

- › Suitable for all wire front releases

✓ Cover for actuator CET



**124979** AM-C-124979

✓ Features

- › Cover for actuator CET
- › Horizontal and vertical fastening option on the actuator
- › Mounting using 4 screws M5x16 (included with the actuator)
- › Not suitable in combination with lockout bar for actuator CET

✓ Lockout mechanism for CET actuator



**122609** AE-L-CET-122609

✓ Features

- › Prevents unintentional closing of the door
- › Can be secured with padlocks
- › Not suitable in combination with cover AM-C for actuator CET



**156429** AE-L-CET-156429

✓ Features

- › Prevents unintentional closing of the door
- › Can be secured with padlocks

✓ Extension of the escape release CET



**127377** AF-E-80-127377

✓ Features

- › Extension of the CET escape release by 30, 50 or 80 mm

✓ Holder for lockout mechanism CET actuator



**156338** Y-CHN-A1-156338

✓ Features



- › Holder (incl. wire rope) for lockout bar CET

---

▼ Lockout bar and holder for CET actuators



**155865** AE-SET-LCHN-A1-155865

▼ Features

- › Prevents unintentional closing of the door
- › Can be secured with padlocks

---

## Connection material

▼ Y-distributor M12



**097627** Y-VERTEILER M12

▼ Features

- › Y-distributor M12, 2 x 5-pin, 1 x 8-pin
- › Straight plug connector

▼ Bridging plug M12



**097645** BRUECKEN-STECKER

▼ Features

- › Bridging plug
- › M12 male plug, 4-pin

▼ M12 extension PUR 5-pin, plug connectors at both ends, 10m



**115566** C-M12F05-05X025PU10,0-M12M05-115566

▼ Features

- › M12 female plug, 5-pin (angled) to M12 plug connector (straight)
- › Connectors at both ends
- › PUR cable
- › Cable length 10 m
- › With cable exit C (left)



**115565** C-M12F05-05X025PU10,0-M12M05-115565

▼ Features

- › M12 female plug, 5-pin (angled) to M12 plug connector (straight)
- › Connectors at both ends
- › PUR cable
- › Cable length 10 m
- › With cable exit A (right)

▼ Connection cable with angled plug connector M12, 5-pin, 10m



**113187** C-M12F05-05X025PU10,0-MA-113187

▼ Features

- › M12 female plug, 5-pin
- › Angled plug connector

- › PUR cable
- › Cable length 10 m
- › Cable exit A (right)
- › With flying lead



**113190** C-M12F05-05X025PU10,0-MA-113190

▣ Features

- › M12 female plug, 5-pin
- › Angled plug connector
- › PUR cable
- › Cable length 10 m
- › Cable exit C (left)
- › With flying lead

▣ Connection cable with angled plug connector M12, 8-pin, 10m



**113189** C-M12F08-08X025PU10,0-MA-113189

▣ Features

- › M12 female plug, 8-pin
- › Angled plug connector
- › Cable outlet C (left)
- › PUR cable
- › Cable length 10 m
- › With flying lead



**113188** C-M12F08-08X025PU10,0-MA-113188

▣ Features

- › M12 female plug, 8-pin
- › Angled plug connector
- › Cable outlet A (right)
- › PUR cable
- › Cable length 10 m
- › With flying lead

▣ Connection cable with plug connector M12, 5-pin, 20m



**100185** C-M12F05-05X034PV20,0-MA-100185

▣ Features

- › M12 female plug, 5-pin
- › Straight plug connector
- › PVC cable
- › Cable length 20 m
- › With flying lead

▣ Connection cable with plug connector M12, 5-pin, 10m



**100184** C-M12F05-05X034PV10,0-MA-100184

▣ Features

- › M12 female plug, 5-pin
- › Straight plug connector
- › PVC cable
- › Cable length 10 m
- › With flying lead

---

▼ Connection cable with 2 plug connectors M12, 5-pin, 20m



**100182** C-M12F05-05X034PV20,0-M12M05-100182

▼ Features

- › M12 female plug to M12 plug connector, 5-pin
- › Straight female plug and plug connector
- › PVC cable
- › Cable length 20 m



**119971** C-M12F05-05X034PU20,0-M12M05-119971

▼ Features

- › M12 female plug to M12 plug connector, 5-pin
- › Straight female plug and plug connector
- › PUR cable
- › Cable length 20 m

---

▼ Connection cable with straight plug connector M12, 5-pin, 5m



**100183** C-M12F05-05X034PV05,0-MA-100183

▼ Features

- › M12 female plug, 5-pin
- › Straight plug connector
- › PVC cable
- › Cable length 5 m
- › With flying lead



**113620** C-M12F05-05X034PU05,0-MA-113620

▼ Features

- › M12 female plug, 5-pin
- › Straight plug connector
- › PUR cable
- › Cable length 5 m
- › With flying lead

---

▼ Connection cable with plug connector M12, 8-pin, 20m



**100179** C-M12F08-08X025PV20,0-MA-100179

▼ Features

- › M12 female plug, 8-pin
- › Straight plug connector
- › PVC cable
- › Cable length 20 m
- › With flying lead



**115114** C-M12F08-08X025PU20,0-MA-115114

▼ Features

- › M12 female plug, 8-pin
- › Straight plug connector
- › PUR cable
- › Cable length 20 m
- › With flying lead

---

▼ Connection cable with 2 plug connectors M12, 5-pin, 10m



**100181** C-M12F05-05X034PV10,0-M12M05-100181

▼ Features

- › M12 female plug to M12 plug connector, 5-pin
- › Straight female plug and plug connector
- › PVC cable
- › Cable length 10 m



**119947** C-M12F05-05X034PU10,0-M12M05-119947

▼ Features

- › M12 female plug to M12 plug connector, 5-pin
- › Straight female plug and plug connector
- › PUR cable
- › Cable length 10 m

---

▼ Connection cable with 2 plug connectors M12, 5-pin, 5m



**100180** C-M12F05-05X034PV05,0-M12M05-100180

▼ Features

- › M12 female plug to M12 plug connector, 5-pin
- › Straight female plug and plug connector
- › PVC cable
- › Cable length 5 m



**119932** C-M12F05-05X034PU05,0-M12M05-119932

▼ Features

- › M12 female plug to M12 plug connector, 5-pin
- › Straight female plug and plug connector
- › PUR cable
- › Cable length 5 m

---

▼ Connection cable with plug connector M12, 8-pin, 10m



**100178** C-M12F08-08X025PV10,0-MA-100178

▼ Features

- › M12 female plug, 8-pin
- › Straight plug connector
- › PVC cable
- › Cable length 10 m
- › With flying lead



**115113** C-M12F08-08X025PU10,0-MA-115113

▼ Features

- › M12 female plug, 8-pin
  - › Straight plug connector
  - › PUR cable
  - › Cable length 10 m
  - › With flying lead
-

▼ Connection cable with plug connector M12, 8-pin, 5m



**100177** C-M12F08-08X025PV05,0-MA-100177

▼ Features

- › M12 female plug, 8-pin
- › Straight plug connector
- › PVC cable
- › Cable length 5 m
- › With flying lead



**115112** C-M12F08-08X025PU05,0-MA-115112

▼ Features

- › M12 female plug, 8-pin
- › Straight plug connector
- › PUR cable
- › Cable length 5 m
- › With flying lead

▼ Y-distributor M12 with connection cable



**111696** Y-VERTEILER M12 MIT ANSCHLUSSKABEL

▼ Features

- › Y-distributor M12 with connection cable, 2 x 5-pin, 1 x 8-pin
- › Straight plug connector
- › PVC cable
- › Cable length 0.2 m



**112395** Y-VERTEILER M12 MIT 1M KABEL

▼ Features

- › Y-distributor M12 with connection cable, 2 x 5-pin, 1 x 8-pin
- › Straight plug connector
- › PVC cable
- › Cable length 1 m

▼ Connection cable with plug connector M12, 8-pin, 30m



**115257** C-M12F08-08X025PU30,0-MA-115257

▼ Features

- › M12 female plug, 8-pin
- › Straight plug connector
- › PUR cable
- › Cable length 30 m
- › With flying lead



**115116** C-M12F08-08X025PV30,0-MA-115116

▼ Features

- › M12 female plug, 8-pin
- › Straight plug connector
- › PVC cable
- › Cable length 30 m
- › With flying lead

▼ Passive distribution module



**120861** AC-DP-04-SA-120861

▼ Features

- › Connection of up to 4 CES-AR, CET-AR, CTP-AR and ESL-AR
  - › LEDs for the indication of the door position on each port
  - › Can be connected in series
- 

▼ Connection cable with angled plug connector M12, 8-pin, 20m



**120998** C-M12F08-08X025PU20,0-MA-120998

▼ Features

- › M12 female plug, 8-pin
  - › Angled plug connector
  - › Cable outlet A (right)
  - › PUR cable
  - › Cable length 20 m
  - › With flying lead
- 



**120999** C-M12F08-08X025PU20,0-MA-120999

▼ Features

- › M12 female plug, 8-pin
  - › Angled plug connector
  - › Cable outlet C (left)
  - › PUR cable
  - › Cable length 20 m
  - › With flying lead
- 

▼ Connection cable with straight plug connector M12, 5-pin, 30 m



**122784** C-M12F05-05X034PU30,0-MA-122784

▼ Features

- › M12 female plug, 5-pin
  - › Straight plug connector
  - › PUR cable
  - › Cable length 30 m
  - › With flying lead
- 

▼ Connection cable with straight plug connector M12, 5-pin, 20 m



**113682** C-M12F05-05X034PU20,0-MA-113682

▼ Features

- › M12 female plug, 5-pin
  - › Straight plug connector
  - › PUR cable
  - › Cable length 20 m
  - › With flying lead
- 

▼ Connection cable with straight plug connector M12, 5-pin, 10m



**113640** C-M12F05-05X034PU10,0-MA-113640

▼ Features

- › M12 female plug, 5-pin
  - › Straight plug connector
  - › PUR cable
  - › Cable length 10 m
  - › With flying lead
- 

▼ Connection cable with 2 plug connectors M12, 1m



**123430** C-M12M08-08X025PV01,0-M12F08-123430

▼ Features

- › 8-pin M12 male plug, straight
  - › 8-pin M12 female connector, straight
  - › PVC cable
  - › Cable length 1m
- 

▼ Connection cable with 2 plug connectors M12, 2m



**123431** C-M12M08-08X025PV02,0-M12F08-123431

▼ Features

- › 8-pin M12 male plug, straight
  - › 8-pin M12 female connector, straight
  - › PVC cable
  - › Cable length 2m
- 

▼ Connection cable with 2 plug connectors M12, 5m



**123432** C-M12M08-08X025PV05,0-M12F08-123432

▼ Features

- › 8-pin M12 male plug, straight
  - › 8-pin M12 female connector, straight
  - › PVC cable
  - › Cable length 5m
- 

▼ Connection cable with 2 plug connectors M12, 10m



**123433** C-M12M08-08X025PV10,0-M12F08-123433

▼ Features

- › 8-pin M12 male plug, straight
  - › 8-pin M12 female connector, straight
  - › PVC cable
  - › Cable length 10m
- 

## Mounting accessories

---

▼ Mounting plate EMP-L-... for CET read head/switches



**106695** EMP-L-CET

▼ Features

- › Mounting plate for CET read heads/switches
- › For hinged or sliding doors

- › Suitable for aluminum profiles 40 ... 45 mm
  - › Horizontal and vertical mounting
  - › Suitable for CET with escape release
- 

▼ Mounting plate EM-P switch for safety switch CET



**126399** AM-P-126399

▼ Features

- › Mounting plate for CET read heads/switches
  - › Direct mounting on aluminum profiles of width 30/40/50 mm
  - › Suitable for the mounting plates AM-P-126400 and AM-P-126398
- 

▼ Mounting plate EM-P handle for safety switch CET



**126398** AM-P-126398

▼ Features

- › Mounting plate with handle (handle included)
  - › For hinged or sliding doors
  - › Horizontal and vertical assembly circuits possible
  - › Suitable for aluminum profiles of width 30/40/50 mm
  - › Suitable for the CET mounting plates AM-P-126399 and AM-P-126400
- 

▼ Mounting plate EM-P actuator for safety switch CET



**126400** AM-P-126400

▼ Features

- › Mounting plate for CET actuator
  - › Suitable for mounting on aluminum profiles of width 30/40/50 mm
  - › Suitable for the mounting plates AM-P-126399 and AM-P-126398
- 

▼ Mounting plate EMP-B-... for actuator CET



**106694** EMP-B-CET

▼ Features

- › Mounting plate for actuator CET for hinged or sliding doors
  - › Suitable for aluminum profiles 40 ... 45 mm
  - › Horizontal and vertical mounting
  - › Made of aluminum
- 

## Instructions

▼ Bezpečnostní informace CET (-AR/-AP)

Doc. no.   Version   Language   Download



Sicherheitsinformation CET (-AR/-AP)	105517	14-01/17		0.7 MB
Información de seguridad CET (-AR/-AP)				
Information de sécurité CET (-AR/-AP)				
Informazioni sulla sicurezza CET (-AR/-AP)				
Safety Information CET (-AR/-AP)				
Bezpečnostní informace CET (-AR/-AP)	105517	14-01/17		0.2 MB
Informação de segurança CET (-AR/-AP)	105517	14-01/17		0.2 MB
Güvenlik bilgisi CET (-AR/-AP)	105517	14-01/17		0.3 MB
安全情報 CET (-AR/-AP)	105517	14-01/17		0.6 MB
Информация о безопасности CET (-AR/-AP)	105517	14-01/17		0.3 MB
安全信息 CET (-AR/-AP)	105517	14-01/17		0.3 MB







**Návod k použití Bezpečnostní spínač s kódovaným transpondérem a jištěním ochranného krytu CET.-AR-... (Unicode/Multicode)**

	<b>Doc. no.</b>	<b>Version</b>	<b>Language</b>	<b>Download</b>
Betriebsanleitung Transpondercodierter Sicherheitsschalter mit Zuhaltung CET.-AR-... (Uni-/Multicode)	2110788	12-07/18		3.3 MB
Mode d'emploi Interrupteur de sécurité à codage par transpondeur avec interverrouillage CET.-AR-... (uni-/multicode)	2110788	12-07/18		3.3 MB
Manual de instrucciones Interruptor de seguridad con codificación por transponder con bloqueo CET.-AR-... (Unicode/Multicode)	2110788	12-07/18		3.3 MB
Návod k použití Bezpečnostní spínač s kódovaným transpondérem a jištěním ochranného krytu CET.-AR-... (Unicode/Multicode)	2110788	12-07/18		3.6 MB
Operating Instructions Transponder-Coded Safety Switch With Guard Locking CET.-AR-... (Unicode/Multicode)	2110788	12-07/18		3.3 MB
Istruzioni di impiego Finecorsa di sicurezza con codifica a transponder con meccanismo di ritenuta CET.-AR-... (Unicode/Multicode)	2110788	12-07/18		3.3 MB
操作指示書トランスポンダー型コード化安全スイッチ CET.-AR-... (ユニコード/マルチコード)	2110788	12-07/18		3.7 MB
Návod na prevádzku Bezpečnostný spínač kódovaný transpondérom s istením CET.-AR-... (Uni-/Multicode)	2110788	12-07/18		3.5 MB
İşletim kılavuzu Kapalı tutmalı CET.-AR-... (Uni-/Multicode)	2110788	12-07/18		3.7 MB
使用说明书应答机编码安全开关 CET.-AR-... (特殊/通用编码)	2110788	12-07/18		3.7 MB
Инструкция по эксплуатации Транспондерный предохранительный выключатель с защитной блокировкой CET.-AR-... (Uni-/Multicode)	2110788	12-07/18		3.8 MB

## Catalogs





**Transpondercodierte Sicherheitsschalter - Verriegelungseinrichtungen und Zuhaltungen**  
**Transponder-coded safety switches - Interlocking devices and guard locking devices**

Interruptores de seguridad con codificación por transponder - Dispositivos de enclavamiento y bloqueos  
 Interrupteurs de sécurité à codage par transpondeur - Dispositifs de verrouillage et interverrouillages





	Doc. no.	Version	Language	Download
Transpondercodierte Sicherheitsschalter - Verriegelungseinrichtungen und Zuhaltungen	127594	02-01/18		 5.2 MB
Interrupteurs de sécurité à codage par transpondeur - Dispositifs de verrouillage et interverrouillages	137558	02-01/18		 5.2 MB
Interruptores de seguridad con codificación por transponder - Dispositivos de enclavamiento y bloqueos	137560	02-01/18		 5.2 MB
Transponder-coded safety switches - Interlocking devices and guard locking devices	127595	02-01/18		 5.1 MB

### Application example





#### Anschluss CET3-AR an PNOZ Multi

	Doc. no.	Version	Language	Download
Anschluss CET3-AR an PNOZ Multi	AP000165	05-03/16		 0.3 MB
Connection of CET3-AR to PNOZ Multi	AP000165	05-03/16		 0.4 MB





#### Anschluss CET3-AR an Pilz PDP67

	Doc. no.	Version	Language	Download
Anschluss CET3-AR an Pilz PDP67	AP000139	07-03/16		 0.4 MB
Connection of CET3-AR to Pilz PDP67	AP000139	07-03/16		 0.4 MB





#### Anschluss CET3-AR an Sicherheits-Schaltgerät PNOZ s4.1

	Doc. no.	Version	Language	Download
Anschluss CET3-AR an Sicherheits-Schaltgerät PNOZ s4.1	AP000110	05-03/16		 0.2 MB
Connection of CET3-AR to safety relay PNOZ s4.1	AP000110	05-03/16		 0.3 MB





#### Anschluss CET3-AR an Sicherheitsrelais ESM-BA..1

	Doc. no.	Version	Language	Download
Anschluss CET3-AR an Sicherheitsrelais ESM-BA..1	AP000109	06-03/16		 0.2 MB
Connection of CET3-AR to Safety Relay ESM-BA..1	AP000109	06-03/16		 0.3 MB

#### Anschluss CET3-AR an Siemens ET 200S







	Doc. no.	Version	Language	Download
Anschluss CET3-AR an Siemens ET 200S	AP000100	05-03/16		 0.3 MB
Connection of CET3-AR to Siemens ET 200S	AP000100	05-03/16		 0.4 MB

#### Anschluss CET3-AR in Reihe an Sicherheitsrelais ESM-BA..1

	Doc. no.	Version	Language	Download
Anschluss CET3-AR in Reihe an Sicherheitsrelais ESM-BA..1	AP000111	06-03/16		 0.3 MB
Connection of serial wired CET3-AR to Safety Relay ESM-BA..1	AP000111	06-03/16		 0.4 MB

## Declaration of conformity

 EU-Konformitätserklärung

	Doc. no.	Version	Language	Download
EU-Konformitätserklärung	2110802	10-01/17		 0.3 MB
Declaración UE de conformidad				
Déclaration UE de conformité				
Dichiarazione di conformità				
EU declaration of conformity				

## CAD data

CAD data for this item on TraceParts