

ITEM 112992 CET3-AR-CRA-CH-50S-SG-112992

Description	Technical data	Accessories	Downloads
-------------	----------------	-------------	-----------



Features

- › Safety switch with guard locking and integrated evaluation electronics
- › Locking force up to 6500 N
- › Up to 20 switches in series
- › Short circuit monitoring
- › 2 safety outputs (semiconductor outputs)
- › Up to category 4/PL e according to EN ISO 13849-1
- › With 2 plug connectors M12
- › Multicode
- › Door monitoring output
- › Indication of the door position by LED
- › Feedback loop / start button
- › Approach direction A (default setting on delivery)

Approach direction

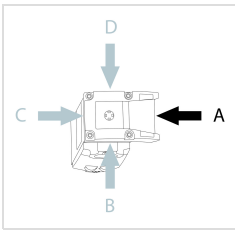

› Figure

Horizontal

Can be adjusted in 90° steps

Safety switch

The device may be operated only in conjunction with the actuator CET-A-....

Important: The actuator must be ordered separately.

Multicode evaluation unit

Every suitable actuator is detected by the switch.

Solenoid operating voltage

› DC 24 V +10% -15%

Guard locking type

CET3 Closed-circuit current principle, guard locking by spring force.

Release by applying voltage to the guard locking solenoid. The door position is also monitored. The door monitoring output OUT D is set to HIGH as soon as the actuator is above the extended plunger (state: door closed, guard locking not active). The output OUT D remains set also with guard locking active.

LED function display

LED State Status LED

LED DIA Diagnostic LED

LED 1 rd freely configurable

LED 2 gn illuminates when door is closed

Additional connections

OUT Monitoring output (semiconductor)

OUT D Door monitoring output

RST Reset input

Y Feedback loop

Category according to EN ISO 13849-1

Due to two redundantly designed semiconductor outputs (safety outputs) with internal monitoring suitable for:

› Category 4/PL e according to EN ISO 13849-1

Important: To achieve the stated category in accordance with EN ISO 13849-1, both safety outputs (OA and OB) must be evaluated.

The category is dependent on the installation position of the safety switch:

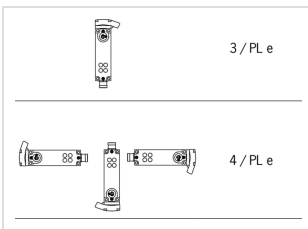

► Figure

Approvals



Mechanical values and environment

Housing material	Slide	Stainless steel
	Safety switch housing	Die-cast aluminum
Weight	Net	1 kg
Ambient temperature	At $U_B = 24V DC$	-20 ... 55 °C
Degree of protection		IP67 [1]
Resilience to vibration		In acc. with EN IEC 60947-5-2
Mechanical life		1×10^6
Installation position		Any [2]
Degree of freedom	Z	± 4 mm
	Y	± 5 mm
	X	± 5 mm
Ready delay		10 s
Switching frequency		max.0,5 Hz
Connection		2 plug connectors M12, 5 and 8-pin
Approach speed		20 m/min
Guard locking principle		Closed-circuit current principle
Locking force F_{max}		6500 N
Locking force F_{Zh}		5000 N [3]

Electrical connection ratings

Operating voltage DC	U_B	24 V DC -15% ... 15% Reverse polarity protected, regulated, residual ripple < 5%, PELV
	LED	24 V DC -15% ... 10%
Current consumption	I_B	80 mA

	I_{CM}	480 mA
Utilization category according to EN 60947-5-2		
	DC-13	24V 200mA [4]
Solenoid operating voltage DC		
	U_{CM}	24 V DC -15% ... +10% Reverse polarity protected, regulated, residual ripple < 5%, PELV
Fusing		
External (operating voltage U_B)		0,25 ... 2 A
External (solenoid operating voltage U_{CM})		0,5 ... 8 A
Power consumption		
	Solenoid	max.12 W
EMC protection requirements		In acc. with EN IEC 60947-5-3
Solenoid duty cycle		100 %
Degree of contamination (external, according to EN 60947-1)		3
Connecting cable		30V DC, 2A [5]
Safety class		
	EN IEC 61140	III
Switching load		
	According to UL	24V DC, class 2 [6]
		Safety outputs OA/OB
Type of output		2 semiconductor outputs, p-switching, short circuit-proof
Switching current		
Per safety output OA / OB		1 ... 200 mA
Output voltage		
High $U(OA) / U(OB)$		$U_B - 1,5V \dots U_B$ V DC
Low $U(OA) / U(OB)$		0 ... 1 V DC
Off-state current I_r		max.0,25 mA
Risk time according to EN 60947-5-3		
Single device		max.400 ms
Delay per device		5 ms
Switch-on time		400 ms
Discrepancy time		
Both safety outputs		max.10 ms
		Monitoring output OUT
Type of output		p-switching, short circuit-proof
Switching current		
OUT		1 ... 50 mA
Output voltage		
OUT		$0,8xU_B \dots U_B$ V DC
Switching delay from state change		max.400 ms
		Monitoring output OUT D
Type of output		p-switching, short circuit-proof
Switching current		
OUT D		1 ... 50 mA

Output voltage	OUT D	0,8xUB ... UB V DC
Switching delay from state change		max.700 ms
Start button / feedback loop		
Input voltage	High	15 ... 27,6 V DC
	Low	0 ... 1 V DC

Operating distance

Repeat accuracy R		
According to EN 60947-5-2		10 %

Miscellaneous

For the approval according to UL the following applies	Operation only with UL class 2 power supply, or equivalent measures see operating instructions
--	--

Reliability values acc. to EN ISO 13849-1

		Monitoring of guard locking and the safety guard position
Category	Head upward	3
	Head downward or horizontal	4
Performance Level		PL e
PFH _D	Head upward	4.29×10^{-8}
	Head downward or horizontal	3.1×10^{-9}
		Control of the guard locking
Category		Depending on external control of guard locking [7]
Performance Level		Depending on external control of guard locking [8]
PFH _D		Depending on external control of guard locking [9]
Mission time		20 y

- [1] Screwed tight plug connector/mating component
- [2] Preferably head downward
- [3] $FZH = FMAX/1.3$
- [4] Caution: outputs must be protected with a free-wheeling diode in case of inductive loads
- [5] For UL requirement UL category code (CYJV/CYJV7)
- [6] For alternatives see operating instructions
- [7, 8, 9] Feedback loop and LEDs have the same ground potential as the guard locking solenoid

Dimension drawing

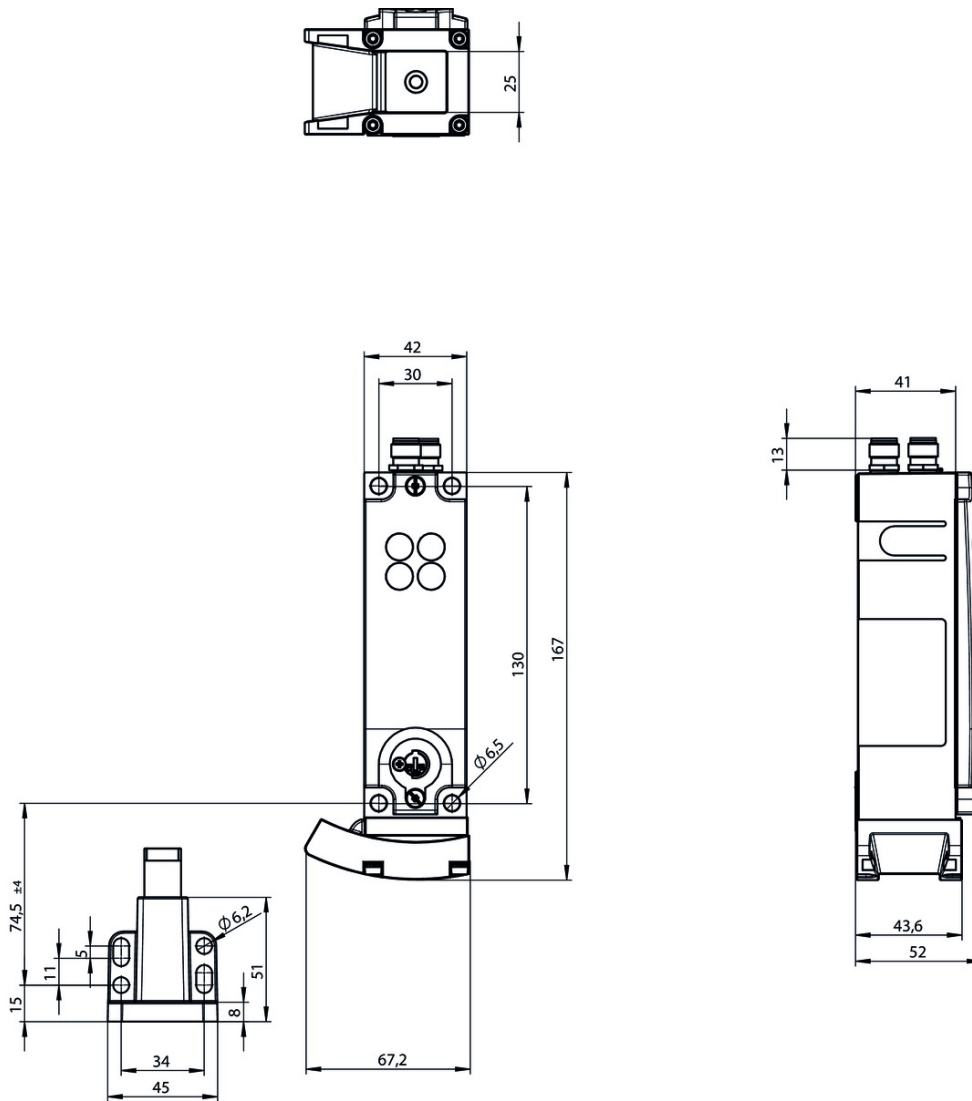

Block diagram

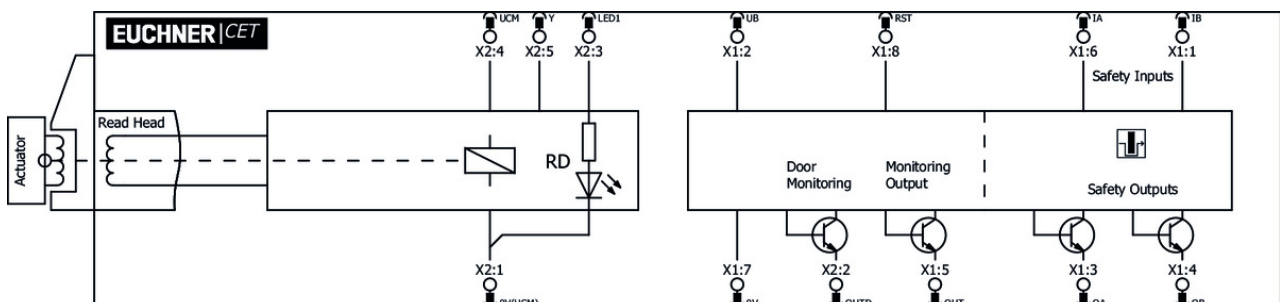

Actuator

▼ Actuator CET-A-BWK-50X



096327 CET-A-BWK-50X

▼ Features

- › Actuator for read head/safety switch CET
 - › Four safety screws M5x16 included
-

Bolt

▼ Bolt CET-A-C



104309 RIEGEL CET-A-C

▼ Features

- › Steel bolt
 - › In combination with CET
 - › For left or right hinged doors
 - › Can be locked in open position with padlocks
-



109672 RIEGEL CET-A-C-C2308

▼ Features

- › Steel bolt
 - › In combination with CET
 - › For left or right hinged doors
 - › Can be locked in open position with padlocks
 - › Bolt without door stop, suitable for swing doors
-

Connection material

▼ Connection cable with plug connector M12, 8-pin, 20m



100179 C-M12F08-08X025PV20,0-MA-100179

▼ Features

- › M12 female plug, 8-pin
 - › Straight plug connector
 - › PVC cable
 - › Cable length 20 m
 - › With flying lead
-



115114 C-M12F08-08X025PU20,0-MA-115114

▼ Features

- › M12 female plug, 8-pin
 - › Straight plug connector
 - › PUR cable
 - › Cable length 20 m
 - › With flying lead
-

▼ Connection cable with plug connector M12, 8-pin, 5m



100177 C-M12F08-08X025PV05,0-MA-100177

▼ Features

- › M12 female plug, 8-pin
- › Straight plug connector
- › PVC cable
- › Cable length 5 m
- › With flying lead



115112 C-M12F08-08X025PU05,0-MA-115112

▼ Features

- › M12 female plug, 8-pin
- › Straight plug connector
- › PUR cable
- › Cable length 5 m
- › With flying lead

▼ Connection cable with plug connector M12, 8-pin, 10m



100178 C-M12F08-08X025PV10,0-MA-100178

▼ Features

- › M12 female plug, 8-pin
- › Straight plug connector
- › PVC cable
- › Cable length 10 m
- › With flying lead



115113 C-M12F08-08X025PU10,0-MA-115113

▼ Features

- › M12 female plug, 8-pin
- › Straight plug connector
- › PUR cable
- › Cable length 10 m
- › With flying lead

▼ Connection cable with 2 plug connectors M12, 5-pin, 10m



100181 C-M12F05-05X034PV10,0-M12M05-100181

▼ Features

- › M12 female plug to M12 plug connector, 5-pin
- › Straight female plug and plug connector
- › PVC cable
- › Cable length 10 m



119947 C-M12F05-05X034PU10,0-M12M05-119947

▼ Features

- › M12 female plug to M12 plug connector, 5-pin
- › Straight female plug and plug connector
- › PUR cable
- › Cable length 10 m

▼ Connection cable with 2 plug connectors M12, 5-pin, 5m



100180 C-M12F05-05X034PV05,0-M12M05-100180

▼ Features

- › M12 female plug to M12 plug connector, 5-pin
 - › Straight female plug and plug connector
 - › PVC cable
 - › Cable length 5 m
-



119932 C-M12F05-05X034PU05,0-M12M05-119932

▼ Features

- › M12 female plug to M12 plug connector, 5-pin
 - › Straight female plug and plug connector
 - › PUR cable
 - › Cable length 5 m
-

▼ Connection cable with 2 plug connectors M12, 5-pin, 20m



100182 C-M12F05-05X034PV20,0-M12M05-100182

▼ Features

- › M12 female plug to M12 plug connector, 5-pin
 - › Straight female plug and plug connector
 - › PVC cable
 - › Cable length 20 m
-



119971 C-M12F05-05X034PU20,0-M12M05-119971

▼ Features

- › M12 female plug to M12 plug connector, 5-pin
 - › Straight female plug and plug connector
 - › PUR cable
 - › Cable length 20 m
-

▼ Connection cable with straight plug connector M12, 5-pin, 5m



100183 C-M12F05-05X034PV05,0-MA-100183

▼ Features

- › M12 female plug, 5-pin
 - › Straight plug connector
 - › PVC cable
 - › Cable length 5 m
 - › With flying lead
-



113620 C-M12F05-05X034PU05,0-MA-113620

▼ Features

- › M12 female plug, 5-pin
 - › Straight plug connector
 - › PUR cable
 - › Cable length 5 m
 - › With flying lead
-

▼ Connection cable with angled plug connector M12, 5-pin, 10m



113187 C-M12F05-05X025PU10,0-MA-113187

▣ Features

- › M12 female plug, 5-pin
 - › Angled plug connector
 - › PUR cable
 - › Cable length 10 m
 - › Cable exit A (right)
 - › With flying lead
-



113190 C-M12F05-05X025PU10,0-MA-113190

▣ Features

- › M12 female plug, 5-pin
 - › Angled plug connector
 - › PUR cable
 - › Cable length 10 m
 - › Cable exit C (left)
 - › With flying lead
-

▣ Connection cable with plug connector M12, 5-pin, 10m



100184 C-M12F05-05X034PV10,0-MA-100184

▣ Features

- › M12 female plug, 5-pin
 - › Straight plug connector
 - › PVC cable
 - › Cable length 10 m
 - › With flying lead
-

▣ Connection cable with plug connector M12, 5-pin, 20m



100185 C-M12F05-05X034PV20,0-MA-100185

▣ Features

- › M12 female plug, 5-pin
 - › Straight plug connector
 - › PVC cable
 - › Cable length 20 m
 - › With flying lead
-

▣ Connection cable with angled plug connector M12, 8-pin, 10m



113188 C-M12F08-08X025PU10,0-MA-113188

▣ Features

- › M12 female plug, 8-pin
 - › Angled plug connector
 - › Cable outlet A (right)
 - › PUR cable
 - › Cable length 10 m
 - › With flying lead
-



113189 C-M12F08-08X025PU10,0-MA-113189

▣ Features

- › M12 female plug, 8-pin

- › Angled plug connector
 - › Cable outlet C (left)
 - › PUR cable
 - › Cable length 10 m
 - › With flying lead
-

▼ M12 extension PUR 5-pin, plug connectors at both ends, 10m



115565 C-M12F05-05X025PU10,0-M12M05-115565

▼ Features

- › M12 female plug, 5-pin (angled) to M12 plug connector (straight)
 - › Connectors at both ends
 - › PUR cable
 - › Cable length 10 m
 - › With cable exit A (right)
-



115566 C-M12F05-05X025PU10,0-M12M05-115566

▼ Features

- › M12 female plug, 5-pin (angled) to M12 plug connector (straight)
 - › Connectors at both ends
 - › PUR cable
 - › Cable length 10 m
 - › With cable exit C (left)
-

▼ Bridging plug M12



097645 BRUECKEN-STECKER

▼ Features

- › Bridging plug
 - › M12 male plug, 4-pin
-

▼ Y-distributor M12



097627 Y-VERTEILER M12

▼ Features

- › Y-distributor M12, 2 x 5-pin, 1 x 8-pin
 - › Straight plug connector
-

▼ Y-distributor M12 with connection cable



111696 Y-VERTEILER M12 MIT ANSCHLUSSKABEL

▼ Features

- › Y-distributor M12 with connection cable, 2 x 5-pin, 1 x 8-pin
 - › Straight plug connector
 - › PVC cable
 - › Cable length 0.2 m
-



112395 Y-VERTEILER M12 MIT 1M KABEL

▼ Features

- › Y-distributor M12 with connection cable, 2 x 5-pin, 1 x 8-pin
- › Straight plug connector

- › PVC cable
 - › Cable length 1 m
-

▼ Connection cable with plug connector M12, 8-pin, 30m



115257 C-M12F08-08X025PU30,0-MA-115257

▼ Features

- › M12 female plug, 8-pin
 - › Straight plug connector
 - › PUR cable
 - › Cable length 30 m
 - › With flying lead
-



115116 C-M12F08-08X025PV30,0-MA-115116

▼ Features

- › M12 female plug, 8-pin
 - › Straight plug connector
 - › PVC cable
 - › Cable length 30 m
 - › With flying lead
-

▼ Passive distribution module



120861 AC-DP-04-SA-120861

▼ Features

- › Connection of up to 4 CES-AR, CET-AR, CTP-AR and ESL-AR
 - › LEDs for the indication of the door position on each port
 - › Can be connected in series
-

▼ Connection cable with angled plug connector M12, 8-pin, 20m



120998 C-M12F08-08X025PU20,0-MA-120998

▼ Features

- › M12 female plug, 8-pin
 - › Angled plug connector
 - › Cable outlet A (right)
 - › PUR cable
 - › Cable length 20 m
 - › With flying lead
-



120999 C-M12F08-08X025PU20,0-MA-120999

▼ Features

- › M12 female plug, 8-pin
 - › Angled plug connector
 - › Cable outlet C (left)
 - › PUR cable
 - › Cable length 20 m
 - › With flying lead
-

▼ Connection cable with straight plug connector M12, 5-pin, 30 m



122784 C-M12F05-05X034PU30,0-MA-122784

▼ Features

- › M12 female plug, 5-pin
 - › Straight plug connector
 - › PUR cable
 - › Cable length 30 m
 - › With flying lead
-

▼ Connection cable with straight plug connector M12, 5-pin, 20 m



113682 C-M12F05-05X034PU20,0-MA-113682

▼ Features

- › M12 female plug, 5-pin
 - › Straight plug connector
 - › PUR cable
 - › Cable length 20 m
 - › With flying lead
-

▼ Connection cable with straight plug connector M12, 5-pin, 10m



113640 C-M12F05-05X034PU10,0-MA-113640

▼ Features

- › M12 female plug, 5-pin
 - › Straight plug connector
 - › PUR cable
 - › Cable length 10 m
 - › With flying lead
-

▼ Connection cable with 2 plug connectors M12, 1m



123430 C-M12M08-08X025PV01,0-M12F08-123430

▼ Features

- › 8-pin M12 male plug, straight
 - › 8-pin M12 female connector, straight
 - › PVC cable
 - › Cable length 1m
-

▼ Connection cable with 2 plug connectors M12, 2m



123431 C-M12M08-08X025PV02,0-M12F08-123431

▼ Features

- › 8-pin M12 male plug, straight
 - › 8-pin M12 female connector, straight
 - › PVC cable
 - › Cable length 2m
-

▼ Connection cable with 2 plug connectors M12, 5m



123432 C-M12M08-08X025PV05,0-M12F08-123432

▼ Features

- › 8-pin M12 male plug, straight

- › 8-pin M12 female connector, straight
 - › PVC cable
 - › Cable length 5m
-

☑ Connection cable with 2 plug connectors M12, 10m



123433 C-M12M08-08X025PV10,0-M12F08-123433

- ☑ Features
- › 8-pin M12 male plug, straight
 - › 8-pin M12 female connector, straight
 - › PVC cable
 - › Cable length 10m
-

Function expansion

☑ Mechanical key release for CET read head/switch



098850 SCHLUESSEL-HILFSENTRIEGELUNG

- ☑ Features
- › Identical locking
 - › Key removable in “unlocked” and “locked” positions
-

☑ Emergency unlocking for CET



103714 NOTENTSPERRUNG CET

☑ Cover for read head and actuator CET



098808 CET ABDECKUNG RECHTS

- ☑ Features
- › Cover for read heads / safety switches CET and actuators CET
 - › For approach direction A
-



098807 CET ABDECKUNG LINKS

- ☑ Features
- › Cover for read heads / safety switches CET and actuators CET
 - › For approach direction C
-

☑ Double ramp for safety switch/read head CET



114091 CET-DR

☑ Cover for actuator CET



124979 AM-C-124979

- ☑ Features
- › Cover for actuator CET

- › Horizontal and vertical fastening option on the actuator
- › Mounting using 4 screws M5x16 (included with the actuator)
- › Not suitable in combination with lockout bar for actuator CET

▼ Lockout mechanism for CET actuator



122609 AE-L-CET-122609

▼ Features

- › Prevents unintentional closing of the door
- › Can be secured with padlocks
- › Not suitable in combination with cover AM-C for actuator CET



156429 AE-L-CET-156429

▼ Features

- › Prevents unintentional closing of the door
- › Can be secured with padlocks

▼ Holder for lockout mechanism CET actuator



156338 Y-CHN-A1-156338

▼ Features

- › Holder (incl. wire rope) for lockout bar CET

▼ Lockout bar and holder for CET actuators



155865 AE-SET-LCHN-A1-155865

▼ Features

- › Prevents unintentional closing of the door
- › Can be secured with padlocks

Mounting accessories

▼ Mounting plate EMP-L-... for CET read head/switches



106695 EMP-L-CET

▼ Features

- › Mounting plate for CET read heads/switches
- › For hinged or sliding doors
- › Suitable for aluminum profiles 40 ... 45 mm
- › Horizontal and vertical mounting
- › Suitable for CET with escape release

▼ Mounting plate EM-P switch for safety switch CET



126399 AM-P-126399

▼ Features

- › Mounting plate for CET read heads/switches
- › Direct mounting on aluminum profiles of width 30/40/50 mm
- › Suitable for the mounting plates AM-P-126400 and AM-P-126398

▼ Mounting plate EM-P actuator for safety switch CET



126400 AM-P-126400

▼ Features

- › Mounting plate for CET actuator
- › Suitable for mounting on aluminum profiles of width 30/40/50 mm
- › Suitable for the mounting plates AM-P-126399 and AM-P-126398

▼ Mounting plate EM-P handle for safety switch CET



126398 AM-P-126398

▼ Features

- › Mounting plate with handle (handle included)
- › For hinged or sliding doors
- › Horizontal and vertical assembly circuits possible
- › Suitable for aluminum profiles of width 30/40/50 mm
- › Suitable for the CET mounting plates AM-P-126399 and AM-P-126400

▼ Mounting plate EMP-B-... for actuator CET



106694 EMP-B-CET

▼ Features























- › Mounting plate for actuator CET for hinged or sliding doors
- › Suitable for aluminum profiles 40 ... 45 mm
- › Horizontal and vertical mounting
- › Made of aluminum

Instructions

▼ Bezpečnostní informace CET (-AR/-AP)



	Doc. no.	Version	Language	Download
Sicherheitsinformation CET (-AR/-AP)	105517	14-01/17		0.7 MB
Información de seguridad CET (-AR/-AP)				
Information de sécurité CET (-AR/-AP)				
Informazioni sulla sicurezza CET (-AR/-AP)				
Safety Information CET (-AR/-AP)				
Bezpečnostní informace CET (-AR/-AP)	105517	14-01/17		0.2 MB
Informação de segurança CET (-AR/-AP)	105517	14-01/17		0.2 MB
Güvenlik bilgisi CET (-AR/-AP)	105517	14-01/17		0.3 MB
安全情報 CET (-AR/-AP)	105517	14-01/17		0.6 MB
Информация о безопасности CET (-AR/-AP)	105517	14-01/17		0.3 MB
安全信息 CET (-AR/-AP)	105517	14-01/17		0.3 MB

▼ Návod k použití Bezpečnostní spínač s kódovaným transpondérem a jištěním ochranného krytu CET.-AR-... (Unicode/Multicode)

	Doc. no.	Version	Language	Download
Betriebsanleitung Transpondercodierter Sicherheitsschalter mit Zuhaltung CET.-AR-... (Uni-/Multicode)	2110788	12-07/18		 3.3 MB
Mode d'emploi Interrupteur de sécurité à codage par transpondeur avec interverrouillage CET.-AR-... (uni-/multicode)	2110788	12-07/18		 3.3 MB
Manual de instrucciones Interruptor de seguridad con codificación por transponder con bloqueo CET.-AR-... (Unicode/Multicode)	2110788	12-07/18		 3.3 MB
Návod k použití Bezpečnostní spínač s kódovaným transpondérem a jištěním ochranného krytu CET.-AR-... (Unicode/Multicode)	2110788	12-07/18		 3.6 MB
Operating Instructions Transponder-Coded Safety Switch With Guard Locking CET.-AR-... (Unicode/Multicode)	2110788	12-07/18		 3.3 MB
Istruzioni di impiego Finecorsa di sicurezza con codifica a transponder con meccanismo di ritenuta CET.-AR-... (Unicode/Multicode)	2110788	12-07/18		 3.3 MB
操作指示書トランスポンダー型コード化安全スイッチ CET.-AR-... (ユニコード/マルチコード)	2110788	12-07/18		 3.7 MB
Návod na prevádzku Bezpečnostný spínač kódovaný transpondérom s istením CET.-AR-... (Uni-/Multicode)	2110788	12-07/18		 3.5 MB
İşletim kılavuzu Kapalı tutmalı CET.-AR-... (Uni-/Multicode)	2110788	12-07/18		 3.7 MB
使用说明书应答机编码安全开关 CET.-AR-... (特殊/通用编码)	2110788	12-07/18		 3.7 MB
Инструкция по эксплуатации Транспондерный предохранительный выключатель с защитной блокировкой CET.-AR-... (Uni-/Multicode)	2110788	12-07/18		 3.8 MB







Catalogs

-  Transpondercodierte Sicherheitsschalter - Verriegelungseinrichtungen und Zuhaltungen
 Transponder-coded safety switches - Interlocking devices and guard locking devices
 Interruptores de seguridad con codificación por transponder - Dispositivos de enclavamiento y bloqueos
 Interrupteurs de sécurité à codage par transpondeur - Dispositifs de verrouillage et interverrouillages

	Doc. no.	Version	Language	Download
Transpondercodierte Sicherheitsschalter - Verriegelungseinrichtungen und Zuhaltungen	127594	02-01/18		 5.2 MB
Interrupteurs de sécurité à codage par transpondeur - Dispositifs de verrouillage et interverrouillages	137558	02-01/18		 5.2 MB
Interruptores de seguridad con codificación por transponder - Dispositivos de enclavamiento y bloqueos	137560	02-01/18		 5.2 MB
Transponder-coded safety switches - Interlocking devices and guard locking devices	127595	02-01/18		 5.1 MB

Declaration of conformity

 EU-Konformitätserklärung

	Doc. no.	Version	Language	Download
EU-Konformitätserklärung	2110802	10-01/17		 0.3 MB
Declaración UE de conformidad				
Déclaration UE de conformité				
Dichiarazione di conformità				
EU declaration of conformity				

CAD data

CAD data for this item on TraceParts