

ITEM 112082 CET4-AP-CRA-AH-50X-SI-112082

Description	Technical data	Accessories	Downloads
-------------	----------------	-------------	-----------



Features

- › Safety switch with guard locking and integrated evaluation electronics
- › Locking force up to 6500 N
- › Direct connection to decentralized peripheral systems (e.g. ET200pro)
- › Short circuit monitoring
- › 2 safety outputs (semiconductor outputs)
- › Up to category 4/PL e according to EN ISO 13849-1
- › With 2 plug connectors M12
- › Unicode
- › Indication of the door position by LED
- › Approach direction A (default setting on delivery)

Approach direction

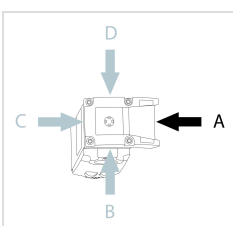

› Figure
Horizontal

Can be adjusted in 90° steps

Safety switch

The device may be operated only in conjunction with the actuator CET-A-....

Important: The actuator must be ordered separately.

Unicode evaluation

Each actuator is unique. The switch detects only taught-in actuators. Additional actuators can be taught in. Only the last actuator taught in is detected.

Solenoid operating voltage

› DC 24 V +10% -15%

Guard locking type

CET4 Open-circuit current principle guard locking by solenoid force.

Activation of the guard locking by applying voltage to the guard locking solenoid.

LED function display

LED State Status LED

LED DIA Diagnostic LED

LED 1 rd illuminates when the solenoid is energized

LED 2 gn illuminates when door is closed

Category according to EN ISO 13849-1

Due to two redundantly designed semiconductor outputs (safety outputs) with internal monitoring suitable for:

› Category 4/PL e according to EN ISO 13849-1

Important: To achieve the stated category in accordance with EN ISO 13849-1, both safety outputs (OA and OB) must be evaluated.

The category is dependent on the installation position of the safety switch:

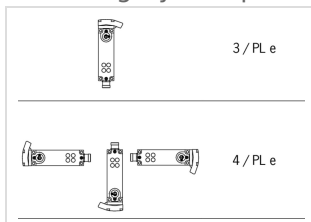

› Figure

Approvals



Mechanical values and environment

Housing material		
	Slide	Stainless steel
	Safety switch housing	Die-cast aluminum
Weight		
	Net	1 kg
Ambient temperature		
	At $U_B = 24V$ DC	-20 ... 55 °C
Degree of protection		IP67 [1]
Resilience to vibration		In acc. with EN IEC 60947-5-2
Mechanical life		1×10^6
Installation position		Any [2]
Degree of freedom		
	Z	± 4 mm
	Y	± 5 mm
	X	± 5 mm
Ready delay		1 s
Switching frequency		max.0,5 Hz
Connection		2 plug connectors M12, 5-pin
Approach speed		20 m/min
Guard locking principle		Open-circuit current principle
Locking force F_{max}		6500 N
Locking force F_{Zh}		5000 N

Electrical connection ratings

Operating voltage DC		
	U_B	24 V DC -15% ... 15% Reverse polarity protected, regulated, residual ripple < 5%, PELV
	LED	24 V DC -15% ... 10%
Current consumption		
	I_B	80 mA
	I_{CM}	480 mA
Utilization category according to EN 60947-5-2		
	DC-13	24V 200mA [3]
Solenoid operating voltage DC		
	U_{CM}	24 V DC -15% ... +10% Reverse polarity protected, regulated, residual ripple < 5%, PELV
Fusing		
	External (operating voltage U_B)	0,25 ... 2 A
	External (solenoid operating voltage U_{CM})	0,5 ... 8 A
Power consumption		
	Solenoid	max.14 W
EMC protection requirements		In acc. with EN IEC 60947-5-3
Solenoid duty cycle		100 %

Degree of contamination (external, according to EN 60947-1)	3
Connecting cable	30V DC, 2A [4]
Safety class EN IEC 61140	III
Switching load According to UL	24V DC, class 2 [5]
Safety outputs OA/OB	
Type of output	2 semiconductor outputs, p-switching, short circuit-proof
Switching current Per safety output OA / OB	1 ... 200 mA
Output voltage High U(OA) / U(OB) Low U(OA) / U(OB)	UB-1,5V ... UB V DC 0 ... 1 V DC
Off-state current I _r	max.0,25 mA
Risk time according to EN 60947-5-3 Single device	max.400 ms
Switch-on time	400 ms
Discrepancy time Both safety outputs	max.10 ms

Operating distance

Repeat accuracy R According to EN 60947-5-2	10 %
--	------

Miscellaneous

For the approval according to UL the following applies	Operation only with UL class 2 power supply, or equivalent measures see operating instructions
--	--

Reliability values acc. to EN ISO 13849-1

	Monitoring of guard locking and the safety guard position
Category Head upward Head downward or horizontal	3 4
Performance Level PFH _D	PL e
Head upward Head downward or horizontal	4.29 x 10 ⁻⁸ 3.1 x 10 ⁻⁹

Mission time	20 y
--------------	------

- [1] Screwed tight plug connector/mating component
- [2] Preferably head downward
- [3] Caution: outputs must be protected with a free-wheeling diode in case of inductive loads
- [4] For UL requirement UL category code (CYJV/CYJV7)
- [5] For alternatives see operating instructions

Dimension drawing

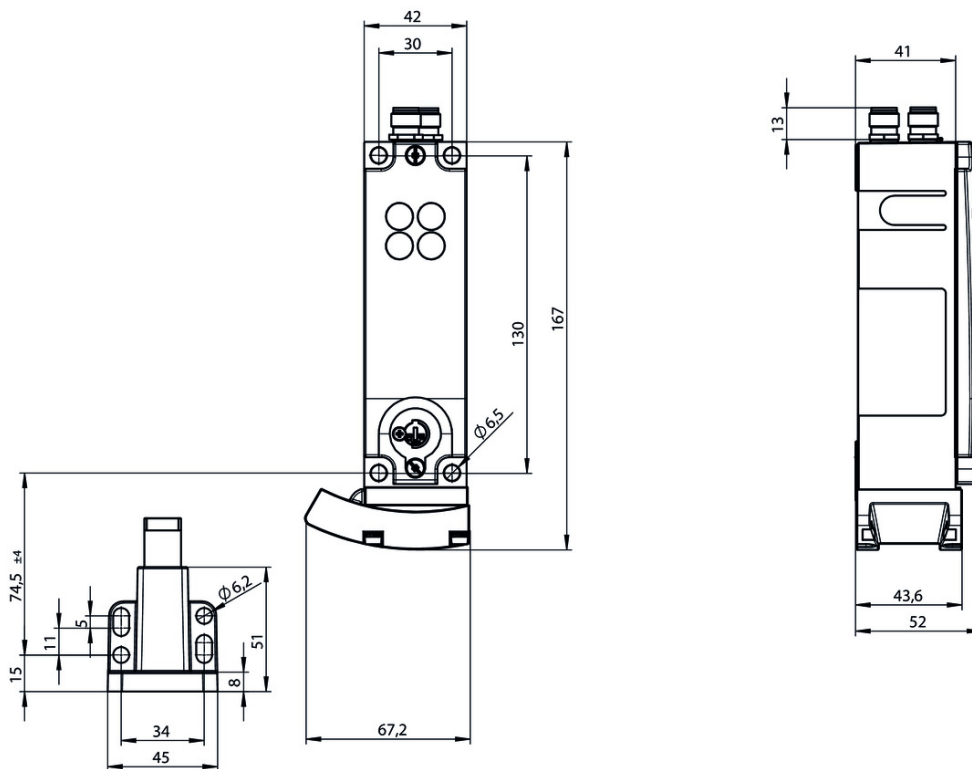
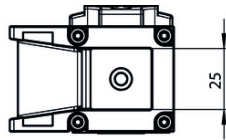

Block diagram

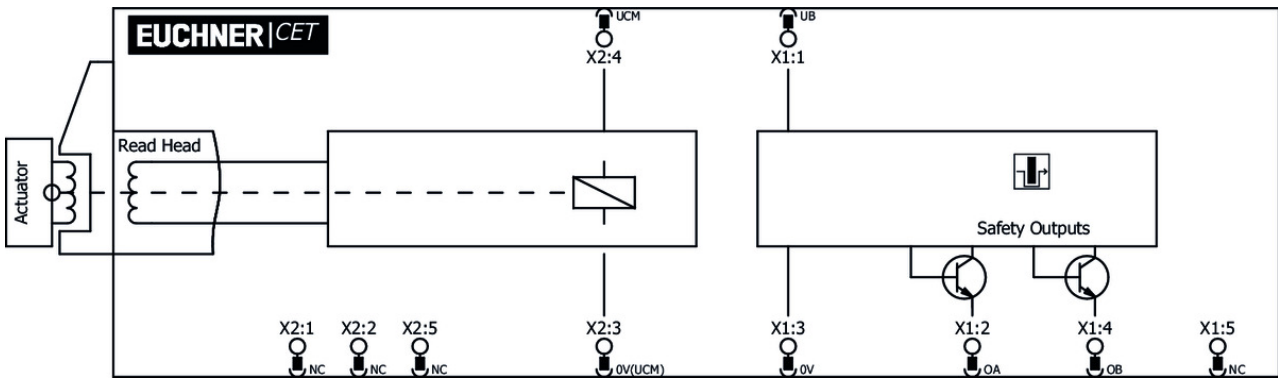

Wiring diagram

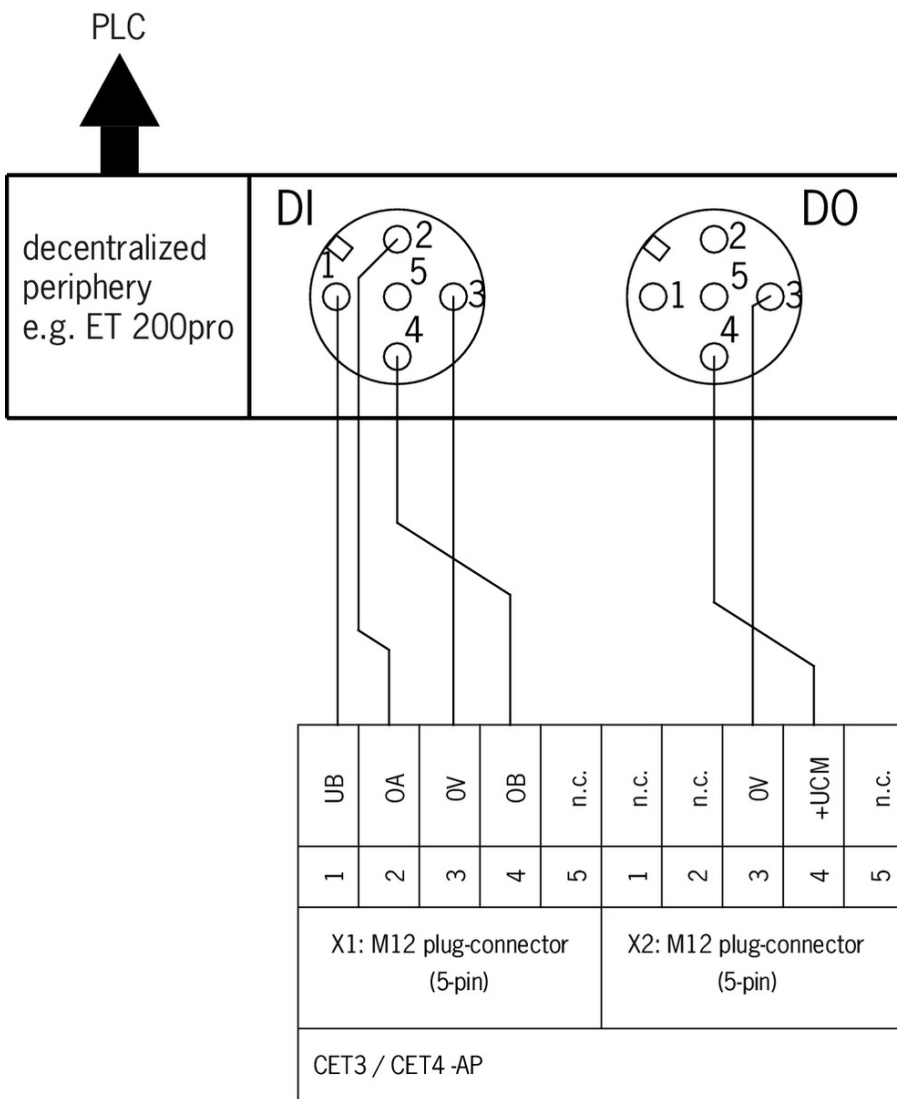

Mounting accessories

- Mounting plate EMP-L... for CET read head/switches



106695 EMP-L-CET

Features

- › Mounting plate for CET read heads/switches
 - › For hinged or sliding doors
 - › Suitable for aluminum profiles 40 ... 45 mm
 - › Horizontal and vertical mounting
 - › Suitable for CET with escape release
-

▼ Mounting plate EM-P switch for safety switch CET



126399 AM-P-126399

▼ Features

- › Mounting plate for CET read heads/switches
 - › Direct mounting on aluminum profiles of width 30/40/50 mm
 - › Suitable for the mounting plates AM-P-126400 and AM-P-126398
-

▼ Mounting plate EM-P actuator for safety switch CET



126400 AM-P-126400

▼ Features

- › Mounting plate for CET actuator
 - › Suitable for mounting on aluminum profiles of width 30/40/50 mm
 - › Suitable for the mounting plates AM-P-126399 and AM-P-126398
-

▼ Mounting plate EM-P handle for safety switch CET



126398 AM-P-126398

▼ Features

- › Mounting plate with handle (handle included)
 - › For hinged or sliding doors
 - › Horizontal and vertical assembly circuits possible
 - › Suitable for aluminum profiles of width 30/40/50 mm
 - › Suitable for the CET mounting plates AM-P-126399 and AM-P-126400
-

▼ Mounting plate EMP-B-... for actuator CET



106694 EMP-B-CET

▼ Features

- › Mounting plate for actuator CET for hinged or sliding doors
 - › Suitable for aluminum profiles 40 ... 45 mm
 - › Horizontal and vertical mounting
 - › Made of aluminum
-

Connection material

▼ Connection cable with 2 plug connectors M12, 5-pin, 5m



100180 C-M12F05-05X034PV05,0-M12M05-100180

▼ Features

- › M12 female plug to M12 plug connector, 5-pin
- › Straight female plug and plug connector
- › PVC cable

- › Cable length 5 m



119932 C-M12F05-05X034PU05,0-M12M05-119932

✓ Features

- › M12 female plug to M12 plug connector, 5-pin
- › Straight female plug and plug connector
- › PUR cable
- › Cable length 5 m

- ✓ Connection cable with 2 plug connectors M12, 5-pin, 10m



100181 C-M12F05-05X034PV10,0-M12M05-100181

✓ Features

- › M12 female plug to M12 plug connector, 5-pin
- › Straight female plug and plug connector
- › PVC cable
- › Cable length 10 m



119947 C-M12F05-05X034PU10,0-M12M05-119947

✓ Features

- › M12 female plug to M12 plug connector, 5-pin
- › Straight female plug and plug connector
- › PUR cable
- › Cable length 10 m

- ✓ Connection cable with 2 plug connectors M12, 5-pin, 20m



100182 C-M12F05-05X034PV20,0-M12M05-100182

✓ Features

- › M12 female plug to M12 plug connector, 5-pin
- › Straight female plug and plug connector
- › PVC cable
- › Cable length 20 m



119971 C-M12F05-05X034PU20,0-M12M05-119971

✓ Features

- › M12 female plug to M12 plug connector, 5-pin
- › Straight female plug and plug connector
- › PUR cable
- › Cable length 20 m

- ✓ M12 extension PUR 5-pin, plug connectors at both ends, 10m



115565 C-M12F05-05X025PU10,0-M12M05-115565

✓ Features

- › M12 female plug, 5-pin (angled) to M12 plug connector (straight)
- › Connectors at both ends
- › PUR cable
- › Cable length 10 m
- › With cable exit A (right)



115566 C-M12F05-05X025PU10,0-M12M05-115566

▼ Features

- › M12 female plug, 5-pin (angled) to M12 plug connector (straight)
 - › Connectors at both ends
 - › PUR cable
 - › Cable length 10 m
 - › With cable exit C (left)
-

▼ Connection cable with angled plug connector M12, 5-pin, 10m



113187 C-M12F05-05X025PU10,0-MA-113187

▼ Features

- › M12 female plug, 5-pin
 - › Angled plug connector
 - › PUR cable
 - › Cable length 10 m
 - › Cable exit A (right)
 - › With flying lead
-



113190 C-M12F05-05X025PU10,0-MA-113190

▼ Features

- › M12 female plug, 5-pin
 - › Angled plug connector
 - › PUR cable
 - › Cable length 10 m
 - › Cable exit C (left)
 - › With flying lead
-

▼ Connection cable with straight plug connector M12, 5-pin, 5m



100183 C-M12F05-05X034PV05,0-MA-100183

▼ Features

- › M12 female plug, 5-pin
 - › Straight plug connector
 - › PVC cable
 - › Cable length 5 m
 - › With flying lead
-



113620 C-M12F05-05X034PU05,0-MA-113620

▼ Features

- › M12 female plug, 5-pin
 - › Straight plug connector
 - › PUR cable
 - › Cable length 5 m
 - › With flying lead
-

▼ Connection cable with plug connector M12, 5-pin, 10m



100184 C-M12F05-05X034PV10,0-MA-100184

▼ Features

- › M12 female plug, 5-pin
- › Straight plug connector
- › PVC cable

- › Cable length 10 m
 - › With flying lead
-

▼ Connection cable with plug connector M12, 5-pin, 20m



100185 C-M12F05-05X034PV20,0-MA-100185

▼ Features

- › M12 female plug, 5-pin
 - › Straight plug connector
 - › PVC cable
 - › Cable length 20 m
 - › With flying lead
-

▼ Connection cable with straight plug connector M12, 5-pin, 30 m



122784 C-M12F05-05X034PU30,0-MA-122784

▼ Features

- › M12 female plug, 5-pin
 - › Straight plug connector
 - › PUR cable
 - › Cable length 30 m
 - › With flying lead
-

▼ Connection cable with straight plug connector M12, 5-pin, 20 m



113682 C-M12F05-05X034PU20,0-MA-113682

▼ Features

- › M12 female plug, 5-pin
 - › Straight plug connector
 - › PUR cable
 - › Cable length 20 m
 - › With flying lead
-

▼ Connection cable with straight plug connector M12, 5-pin, 10m



113640 C-M12F05-05X034PU10,0-MA-113640

▼ Features

- › M12 female plug, 5-pin
 - › Straight plug connector
 - › PUR cable
 - › Cable length 10 m
 - › With flying lead
-

Function expansion

▼ Mechanical key release for CET read head/switch



098850 SCHLUESSEL-HILFSENTRIEGELUNG

▼ Features

- › Identical locking
- › Key removable in “unlocked” and “locked” positions

▼ Emergency unlocking for CET



103714 NOTENTSPERRUNG CET

▼ Cover for read head and actuator CET



098808 CET ABDECKUNG RECHTS

▼ Features

- › Cover for read heads / safety switches CET and actuators CET
- › For approach direction A



098807 CET ABDECKUNG LINKS

▼ Features

- › Cover for read heads / safety switches CET and actuators CET
- › For approach direction C

▼ Double ramp for safety switch/read head CET



114091 CET-DR

▼ Cover for actuator CET



124979 AM-C-124979

▼ Features

- › Cover for actuator CET
- › Horizontal and vertical fastening option on the actuator
- › Mounting using 4 screws M5x16 (included with the actuator)
- › Not suitable in combination with lockout bar for actuator CET

▼ Lockout mechanism for CET actuator



122609 AE-L-CET-122609

▼ Features

- › Prevents unintentional closing of the door
- › Can be secured with padlocks
- › Not suitable in combination with cover AM-C for actuator CET



156429 AE-L-CET-156429

▼ Features

- › Prevents unintentional closing of the door
- › Can be secured with padlocks

▼ Holder for lockout mechanism CET actuator



156338 Y-CHN-A1-156338

▼ Features

- › Holder (incl. wire rope) for lockout bar CET
-

▼ Lockout bar and holder for CET actuators



155865 AE-SET-LCHN-A1-155865

▼ Features

- › Prevents unintentional closing of the door
 - › Can be secured with padlocks
-

Actuator

▼ Actuator CET-A-BWK-50X



096327 CET-A-BWK-50X

▼ Features

- › Actuator for read head/safety switch CET
 - › Four safety screws M5x16 included
-

Bolt

▼ Bolt CET-A-C



104309 RIEGEL CET-A-C

▼ Features

- › Steel bolt
 - › In combination with CET
 - › For left or right hinged doors
 - › Can be locked in open position with padlocks
-



109672 RIEGEL CET-A-C-C2308

▼ Features

- › Steel bolt
 - › In combination with CET
 - › For left or right hinged doors
 - › Can be locked in open position with padlocks
 - › Bolt without door stop, suitable for swing doors
-

Instructions

- ▼ Betriebsanleitung Transpondercodierter Sicherheitsschalter mit Zuhaltung CET.-AP-... (Uni-/Multicode)

Doc. no. Version Language Download

Betriebsanleitung Transpondercodierter Sicherheitsschalter mit Zuhaltung CET.-AP-... (Uni-/Multicode)	2122242	04-05/18		2.5 MB
Mode d'emploi Interrupteur de sécurité à codage par transpondeur avec interverrouillage CET.-AP-... (uni-/multicode)	2122242	04-05/18		2.6 MB
Manual de instrucciones Interruptor de seguridad con codificación por transponder con bloqueo CET.-AP-... (Unicode/Multicode)	2122242	04-05/18		2.6 MB
Operating Instructions Transponder-Coded Safety Switch With Guard Locking CET.-AP-... (Unicode/Multicode)	2122242	04-05/18		2.5 MB
Istruzioni di impiego Finecorsa di sicurezza con codifica a transponder con meccanismo di ritenuta CET.-AP-... (Unicode/Multicode)	2122242	04-05/18		2.5 MB
使用说明书 应答机编码安全开关 CET.-AP-... (特殊/通用编码)	2122242	04-05/18		2.9 MB

Bezpečnostní informace CET (-AR/-AP)

	Doc. no.	Version	Language	Download
Sicherheitsinformation CET (-AR/-AP)	105517	14-01/17		0.7 MB
Información de seguridad CET (-AR/-AP)				
Information de sécurité CET (-AR/-AP)				
Informazioni sulla sicurezza CET (-AR/-AP)				
Safety Information CET (-AR/-AP)				
Bezpečnostní informace CET (-AR/-AP)	105517	14-01/17		0.2 MB
Informação de segurança CET (-AR/-AP)	105517	14-01/17		0.2 MB
Güvenlik bilgisi CET (-AR/-AP)	105517	14-01/17		0.3 MB
安全情報 CET (-AR/-AP)	105517	14-01/17		0.6 MB
Информация о безопасности CET (-AR/-AP)	105517	14-01/17		0.3 MB
安全信息 CET (-AR/-AP)	105517	14-01/17		0.3 MB





Catalogs

Transpondercodierte Sicherheitsschalter - Verriegelungseinrichtungen und Zuhaltungen
Transponder-coded safety switches - Interlocking devices and guard locking devices
Interruptores de seguridad con codificación por transponder - Dispositivos de enclavamiento y bloqueos
Interrupteurs de sécurité à codage par transpondeur - Dispositifs de verrouillage et interverrouillages

	Doc. no.	Version	Language	Download
Transpondercodierte Sicherheitsschalter - Verriegelungseinrichtungen und Zuhaltungen	127594	02-01/18		5.2 MB
Interrupteurs de sécurité à codage par transpondeur - Dispositifs de verrouillage et interverrouillages	137558	02-01/18		5.2 MB
Interruptores de seguridad con codificación por transponder - Dispositivos de enclavamiento y bloqueos	137560	02-01/18		5.2 MB
Transponder-coded safety switches - Interlocking devices and guard locking devices	127595	02-01/18		5.1 MB

Application example





▼ Anschluss CET4-AP an MURR MVK-MPNIO

	Doc. no.	Version	Language	Download
Anschluss CET4-AP an MURR MVK-MPNIO	AP000170	05-03/16		 0.3 MB
Connection of CET4-AP to MURR MVK-MPNIO	AP000170	05-03/16		 0.3 MB





▼ Anschluss CET4-AP an Siemens ET 200S

	Doc. no.	Version	Language	Download
Anschluss CET4-AP an Siemens ET 200S	AP000105	05-03/16		 0.3 MB
Connection of CET4-AP to Siemens ET 200S	AP000105	05-03/16		 0.3 MB

▼ Anschluss CET4-AP an Siemens ET 200pro





	Doc. no.	Version	Language	Download
Anschluss CET4-AP an Siemens ET 200pro	AP000107	07-03/16		 0.3 MB
Connection of CET4-AP to Siemens ET 200pro	AP000107	07-03/16		 0.3 MB

▼ Anschluss CET4-AP an Siemens ET 200pro

	Doc. no.	Version	Language	Download
Anschluss CET4-AP an Siemens ET 200pro	AP000195	04-03/16		 0.2 MB
Connection of CET4-AP to Siemens ET 200pro	AP000195	04-03/16		 0.3 MB

Declaration of conformity

▼ EU-Konformitätserklärung

	Doc. no.	Version	Language	Download
EU-Konformitätserklärung	2110802	10-01/17		 0.3 MB
Declaración UE de conformidad				
Déclaration UE de conformité				
Dichiarazione di conformità				
EU declaration of conformity			