

ITEM 104775 CES-AZ-AES-02B

Description	Technical data	Accessories	Downloads
-------------	----------------	-------------	-----------



Features

- › Two read heads can be connected
- › 2 safety outputs (relay contacts with 2 internally connected NO contacts per output)
- › Start button and feedback loop can be connected
- › Unicode
- › Plug-in connection terminals
- › Category 4/PL e according to EN ISO 13849-1

Unicode evaluation

Each actuator is unique. The evaluation unit detects only the actuator that has been taught-in. Additional actuators can be taught in. Only the last actuator taught in is detected. New actuators are taught-in by fitting a jumper.

Guard lock monitoring

Evaluation units in the series CES-AZ make it possible to use read heads with integrated guard locking for the protection of personnel during overtraveling machine movements. You will find suitable read heads in the accessories

Category according to EN ISO 13849-1

Due to two redundant safety paths (relay contacts) with 2 internal, monitored normally open contacts per safety path, suitable for:

› Category 4/PL e according to EN ISO 13849-1

Each safety path is independently safe.

LED indicator

STATE Status LED

DIA Diagnostics LED

OUT Safety output status

Additional connections

TST Input for self-test

O1, O2 Monitoring outputs (semiconductor)

DIA Diagnostics output

Y1, Y2 Feedback loop

J1, J2 Teach-in input

S Start button connection (monitoring of the falling edge)

Important: The plug-in connection terminals are not included and must be ordered separately.

Approvals



Mechanical values and environment

Housing material	Plastic PA6.6
Weight	Net 0,25 kg
Ambient temperature	
At $U_B = 24V$ DC	-20 ... 55 °C
Atmospheric humidity	
Not condensing	max.80 % rH
Degree of protection	IP20
Mounting method	Mounting rail 35mm according to DIN EN 60715 TH35
Mounting distance	
Sideways toward the neighboring device	min.10 mm ^[1]
Number of read heads	Max. 2 read heads can be connected
Ready delay	10 ... 12 s ^[2]
Reaction time	
After change in the actuation status, 1 active actuator	max.210 ms ^[3]

After change in the actuation status, 2 active actuators	max.290 ms ^[4]
Duration of operation start button (for Manual start operating mode)	min.250 ms
Response delay start button (for Manual start operating mode)	200 ... 300 ms
Switching frequency	max.0,25 Hz ^[5]
Dwell time	min.3 s ^[6]
Connection	Plug-in connection terminals, coded ^[7]
Safety contacts 13/14, 23/24	
Number of safety contacts	2 Relays with internally monitored contacts
Mechanical life	
Operating cycles (relay)	10 x 10 ⁶

Electrical connection ratings

Operating voltage DC	U _B	21 ... 24 ... 27 V DC
Current consumption (with relay energized)		150 mA ^[8]
Fusing		
External (operating voltage U _B)		0,4 ... 8 A
EMC protection requirements		In acc. with EN 60947-5-3
Degree of contamination (external, according to EN 60947-1)		2
Connection cross-section (plug-in screw- / springterminals)		0,25 ... 2,5 mm ²
Current via feedback loop		5 ... 8 ... 10 mA
permissible resistance in feedback loop		max.600 Ω
		Monitoring outputs: Diagnostic DIA, door monitoring outputs O1,O2
Type of output		Semiconductor output, p-switching, short circuit-proof
Output voltage		0,8 x U _B ... U _B V DC
Output current		max.20 mA
		Inputs: Start button S, test input TST
Input current	HIGH	5 ... 8 ... 10 mA
Input voltage	HIGH	15 ... U _B V DC
	LOW	0 ... 2 V DC
		Safety contacts 13/14, 23/24
Type of output		Relay contacts, floating
Switching current		
At switching voltage AC/DC 21 ... 60 V		1 ... 300 mA
At switching voltage AC/DC 5 ... 30 V		10 ... 6000 mA

At switching voltage AC 5 ... 230 V	10 ... 2000 mA
Fusing	
External (safety circuit) according to EN 60269-1	6 AgG or 6 A circuit breaker (characteristic B or C)
Utilization category according to EN 60947-5-1	
	AC-15 230 V 2 A
	DC-13 24 V 3 A
	AC-12 60 V 0.3 A 30 V 6 A
	DC-12 60 V 0.3 A 30 V 6 A
Switching load	
According to c UL us	Max. AC 30 V, class 2 / max. DC 60 V, class 2
Rated insulation voltage U_i	250 V
Rated impulse withstand voltage U_{imp}	max.4 kV
Rated conditional short-circuit current	100 A
Discrepancy time (Between the operating points of both relays)	max.25 ms
	STATE LED
LED indicator	Status LED
	LED OUT
LED indicator	Safety contacts status
	DIA LED
LED indicator	Diagnostics LED

Operating distance

Repeat accuracy R	
According to EN 60947-5-2	max.10 %

Miscellaneous

For the approval according to UL the following applies	Operation only with UL class 2 power supply, or equivalent measures
--	---

Reliability values acc. to EN ISO 13849-1

	Monitoring of the safety guard position
Category	4 [9]
Performance Level	PL e [10]
PFH _D	1.9×10^{-8} [11]

Diagnostic Coverage (DC)	99 %
--------------------------	------

Number of switching cycles	
≤ 0.1 A at 24 V DC	max.760000 1/Jahr
≤ 1 A at 24 V DC	max.153000 1/Jahr
≤ 3 A at 24 V DC	max.34600 1/Jahr
Mission time	20 y [12]

in combination with Read head CES-A-LNA-05V, CES-A-LNA-10V, CES-A-LNA-15V, CES-A-LNA-25V, CES-A-LNA-SC, CES-A-LNA-05P, CES-A-LNA-10P, CES-A-LNA-15P, CES-A-LCA-10V and Actuator CES-A-BBA, CES-A-BCA

Mechanical values and environment

Mounting distance	
Neighboring read heads	min.50 mm

Operating distance

Distance s, actuator	
Minimum distance for side approach direction	min.3 mm
Switch-on distance	
With center offset $m=0$	15 mm [13]
Assured switch-off distance S_{ar}	max.26 mm
Assured operating distance S_{a0}	
With center offset $m=0$	min.10 mm [14]
Switching hysteresis	0,5 ... 2 mm [15]

in combination with Read head CES-A-LNA-05V, CES-A-LNA-10V, CES-A-LNA-15V, CES-A-LNA-25V, CES-A-LNA-SC, CES-A-LNA-05P, CES-A-LNA-10P, CES-A-LNA-15P, CES-A-LCA-10V and Actuator CES-A-BDA-20

Mechanical values and environment

Mounting distance	
Neighboring read heads	min.50 mm

Operating distance

Distance s, actuator	
Minimum distance for side approach direction	min.4 mm [16]
Switch-on distance	
With center offset $m=0$	16 mm [17]
Assured switch-off distance S_{ar}	max.33 mm
Assured operating distance S_{a0}	
With center offset $m=0$	min.11 mm [18]
Switching hysteresis	0,5 ... 2 mm [19]

in combination with Read head CES-A-LMN-SC and Actuator CES-A-BMB

Mechanical values and environment

Mounting distance	
Neighboring read heads	min.20 mm

Operating distance

Distance s, actuator	
Minimum distance	min.1,2 mm
Switch-on distance	
With center offset m=0	5 mm [20]
Assured switch-off distance S_{ar}	max.10 mm
Assured operating distance S_{a0}	
With center offset m=0	min.3,5 mm [21]
Switching hysteresis	0,1 ... 0,3 mm [22]

in combination with Read head CES-A-LNA-05V, CES-A-LNA-10V, CES-A-LNA-15V, CES-A-LNA-25V, CES-A-LNA-SC, CES-A-LNA-05P, CES-A-LNA-10P, CES-A-LNA-15P, CES-A-LCA-10V and Actuator CES-A-BDA-18-156935

Mechanical values and environment

Mounting distance	
Neighboring read heads	min.50 mm

Operating distance

Distance s, actuator	
Minimum distance for side approach direction	min.5 mm
Switch-on distance	
With center offset m=0	16 mm [23]
Assured switch-off distance S_{ar}	max.32 mm
Assured operating distance S_{a0}	
With center offset m=0	min.10 mm [24]
Switching hysteresis	
With center offset m=0	0,5 ... 1,4 mm [25]

in combination with Read head CES-A-LNN-SC-106601, CES-A-LNN-05V-106602, CES-A-LNN-10V-113294, CES-A-LNN-25V-115107 and Actuator CES-A-BBN-106600

Mechanical values and environment

Mounting distance	
Neighboring read heads	min.160 mm

Operating distance

Switch-on distance	
In z direction (with center offset x,y=0), in x direction (with center offset y,z=0)	15 mm [26]
Assured switch-off distance S_{ar}	
In y direction	max.100 mm
in x or z direction	max.50 mm

Assured operating distance S_{a0} In z direction (with center offset $x,y=0$), in x direction (with center offset $y,z=0$)	min.10 mm [27]
Switching hysteresis	1 ... 4 mm [28]

in combination with Read head CES-A-LNN-SC-106601, CES-A-LNN-05V-106602, CES-A-LNN-10V-113294, CES-A-LNN-25V-115107 and Actuator CES-A-BDN-06-104730

Mechanical values and environment

Mounting distance Neighboring read heads	min.160 mm
---	------------

Operating distance

Switch-on distance In z direction (with center offset $x,y=0$), in x direction (with center offset $y,z=0$)	19 mm [29]
Assured switch-off distance S_{ar} In y direction in x or z direction	max.100 mm max.50 mm
Assured operating distance S_{a0} In z direction (with center offset $x,y=0$), in x direction (with center offset $y,z=0$)	min.14 mm [30]
Switching hysteresis	4 mm [31]

in combination with Read head CES-A-LSP-05V-104966, CES-A-LSP-10V-104967, CES-A-LSP-25V-104968, CES-A-LSP-SB-104969, CES-A-LSP-15V-106271, CES-A-LSP-20V-106272 and Actuator CES-A-BSP-104970

Operating distance

Switch-on distance With center offset $m=0$	20 mm [32]
Assured switch-off distance S_{ar}	max.45 mm
Assured operating distance S_{a0} With center offset $m=0$	min.10 mm [33]
Switching hysteresis	1 ... 4 mm [34]

in combination with Read head CES-A-LQA-SC and Actuator CES-A-BQA

Mechanical values and environment

Mounting distance Neighboring read heads	min.80 mm
---	-----------

Operating distance

Switch-on distance	
--------------------	--

For vertical approach direction (center offset m=0)	23 mm [35]
For side approach direction (distance in x direction 10 mm)	± 28 mm [36]
Assured switch-off distance S_{ar}	max.60 mm
Assured operating distance S_{a0}	
For vertical approach direction (center offset m=0)	min.16 mm [37]
For side approach direction (distance in x direction 10 mm)	min.± 24 mm [38]
Switching hysteresis	
For vertical approach direction (center offset m=0)	2 ... 3 mm [39]
For side approach direction (distance in x direction 10 mm)	1 ... 1,3 mm [40]

in combination with Read head CES-A-LQA-SC and Actuator CES-A-BBA, CES-A-BCA

Mechanical values and environment

Mounting distance	
Neighboring read heads	min.80 mm

Operating distance

Switch-on distance	
For vertical approach direction (center offset m=0)	15 mm [41]
For side approach direction (distance in x direction 8 mm)	± 22 mm [42]
Assured switch-off distance S_{ar}	max.47 mm
Assured operating distance S_{a0}	
For vertical approach direction (center offset m=0)	min.10 mm [43]
For side approach direction (distance in x direction 8 mm)	min.± 18 mm [44]
Switching hysteresis	
For vertical approach direction (center offset m=0)	2 ... 3 mm [45]
For side approach direction (distance in x direction 8 mm)	1 ... 1,8 mm [46]

in combination with Read head CES-A-LMN-SC and Actuator CES-A-BDA-20

Mechanical values and environment

Mounting distance	
Neighboring read heads	min.20 mm

Operating distance

Switch-on distance	
--------------------	--

With center offset $m=0$	A distance of $s = 4$ mm must be maintained for a side approach direction. 9 mm [47]
Assured switch-off distance S_{ar}	
With center offset $m=0$	max.26 mm [48]
Assured operating distance S_{a0}	
With center offset $m=0$	min.6 mm [49]
Switching hysteresis	
With center offset $m=0$	1 ... 1,8 mm [50]

in combination with Read head CES-A-LMN-SC and Actuator CES-A-BBA

Mechanical values and environment

Mounting distance	
Neighboring read heads	min.20 mm

Operating distance

Switch-on distance	
With center offset $m=0$	A distance of $s = 3$ mm must be maintained for a side approach direction. 8 mm [51]
Assured switch-off distance S_{ar}	
With center offset $m=0$	max.25 mm [52]
Assured operating distance S_{a0}	
With center offset $m=0$	min.5 mm [53]
Switching hysteresis	
With center offset $m=0$	1 ... 1,8 mm [54]

- [1]** If several evaluation units are mounted side by side in a control cabinet without air circulation (e.g. fan), a minimum distance of 10 mm must be maintained between the evaluation units. The distance enables heat from the evaluation unit to dissipate.
- [2]** After the operating voltage is switched on, the relay outputs are switched off and the door monitoring outputs are set LOW during the ready delay. For the visual indication of the delay, the green STATE LED flashes at a frequency of approx. 15 Hz.
- [3, 4]** Corresponds to the risk time according to EN 60947-5-3. This is the maximum switch-off delay for the safety outputs following removal of the actuator. In case of EMC interference in excess of the requirements in accordance with EN 60947-5-3, the switch-off delay can increase to max. 430 ms. After a brief actuation < 0.4 s, the switch-on delay can increase to max. 3 s if this is followed immediately by further actuation.
- [5]** In case of monitoring with feedback loop, the actuators must remain outside the operating distance, e.g. with a door open, until the feedback circuit is closed.
- [6]** The dwell time is the time that the actuator must be inside or outside the operating distance.
- [7]** Terminals not included
- [8]** Without taking into account the load currents on the monitoring outputs
- [9, 10, 11, 12]** This value is dependent on the number of switching cycles and the switching current.
- [13, 14, 15, 23, 24, 25, 26, 27, 28, 29, 30, 31]** These values apply for the surface installation of the read head and the actuator.
- [16, 17, 18, 19]** On mounting in non-metallic environment
- [20, 21, 22]** These values apply for surface installation of the read head in steel.
- [32, 33, 34]** These values apply for the installation of the read head and the actuator in an aluminum profile 45 x 45 mm.
- [35, 36, 37, 38, 39, 40, 41, 42, 43, 44, 45, 46]** These values apply for surface installation of the read head and the actuator.
- [47, 48, 49, 51, 52, 53]** This value applies for the surface installation of the read head in metal and the non-metallic installation of the actuator.
- [50, 54]** These values apply for the surface installation of the read head in metal and the non-metallic installation of the actuator.

Dimension drawing

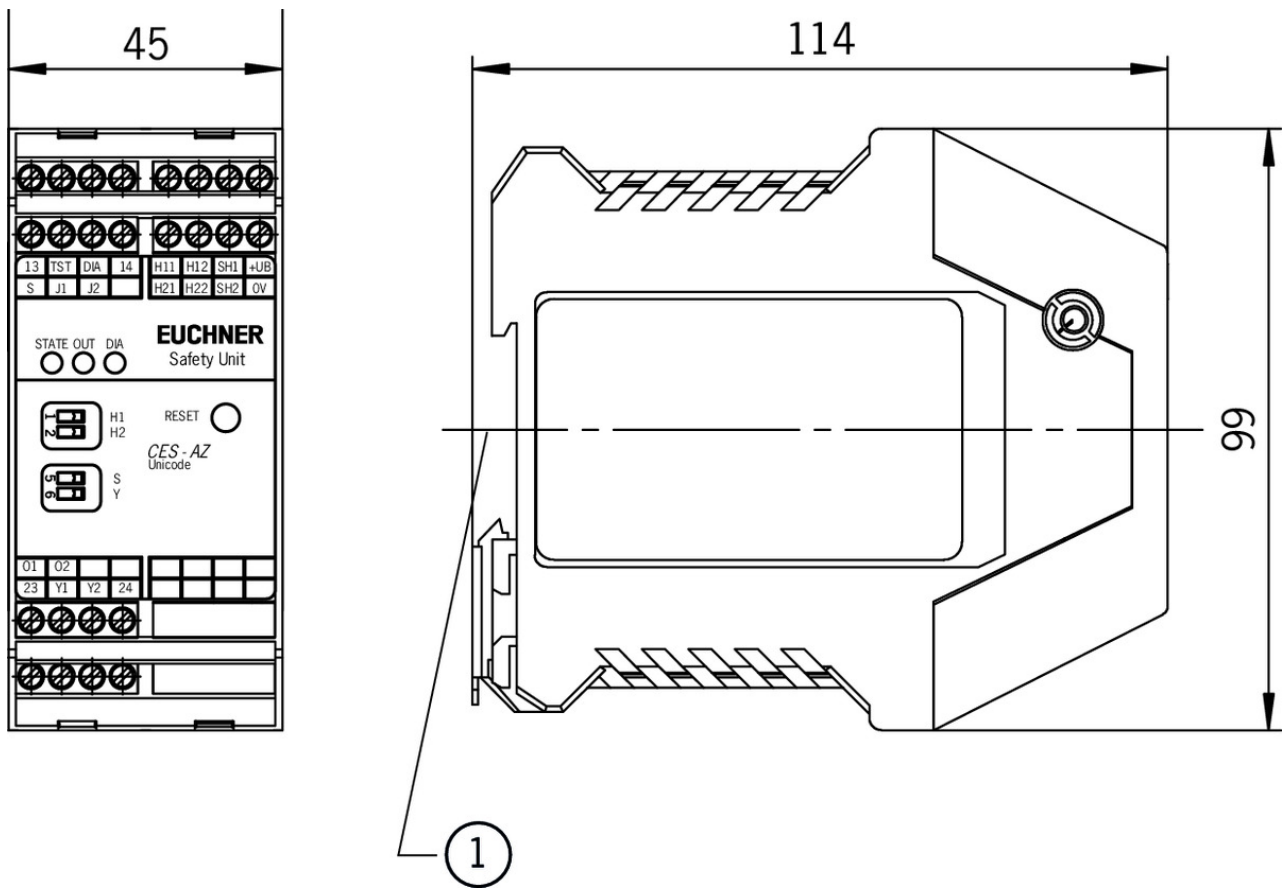

Legende

1 Suitable for 35 mm mounting rail according to EN 60715

Block diagram

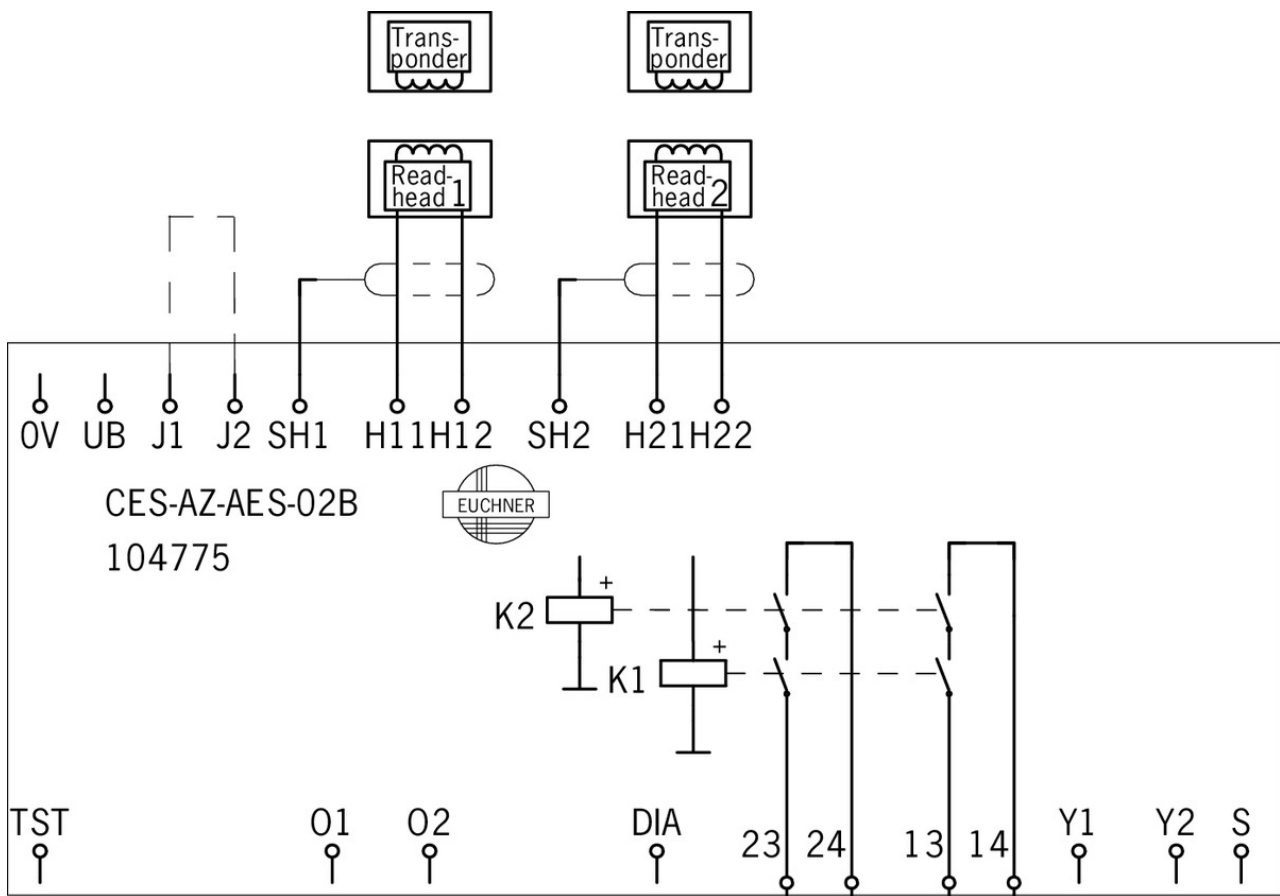

Additional system components

- ▼ Read head CES-A-LSP-SB..., plug connector M5



104969 CES-A-LSP-SB-104969

▼ Features

- › Optimized for aluminum profile mounting
- › LED for the indication of the door position
- › M5 plug connector

- ▼ Read head CET1-AX-..., 2 plug connectors M8, with guard locking and guard lock monitoring



102988 CET1-AX-LRA-00-50X-SC

▼ Features

- › Read head with guard locking
- › Locking force up to 6500 N
- › Up to category 4/PL e according to EN ISO 13849-1
- › With 2 plug connectors M8
- › 2 LEDs (1 freely configurable)
- › Approach direction A (default setting on delivery)

- ▼ Read head CET1-AX-... M12, with guard locking and guard lock monitoring, escape release, double insertion slide

103750 CET1-AX-LDA-00-50F-SA



✓ Features

- › Read head with guard locking
 - › Locking force up to 6500 N
 - › Up to category 4/PL e according to EN ISO 13849-1
 - › With plug connector M12
 - › 2 LEDs (1 freely configurable)
 - › With escape release, 75 mm long
 - › With double ramp
 - › Approach direction A and C (default setting on delivery)
-

- ✓ Read head CET1-AX-..., 2 plug connectors M8, with guard locking and guard lock monitoring, double insertion slide



103444 CET1-AX-LDA-00-50X-SC

✓ Features

- › Read head with guard locking
 - › Locking force up to 6500 N
 - › Up to category 4/PL e according to EN ISO 13849-1
 - › With 2 plug connectors M8
 - › 2 LEDs (1 freely configurable)
 - › With double ramp
 - › Approach direction A and C (default setting on delivery)
-

- ✓ Read head CES-A-LSP-..., hard-wired encapsulated cable 5 m, PVC



104966 CES-A-LSP-05V-104966

✓ Features

- › Optimized for aluminum profile mounting
 - › LED for the indication of the door position
 - › Hard-wired encapsulated cable made of PVC
 - › Cable length 5 m
-

- ✓ Read head CES-A-LSP-..., hard-wired encapsulated cable 15 m, PVC



106271 CES-A-LSP-15V-106271

✓ Features

- › Optimized for aluminum profile mounting
 - › LED for the indication of the door position
 - › Hard-wired encapsulated cable made of PVC
 - › Cable length 15 m
-

- ✓ Read head CES-A-LSP-..., hard-wired encapsulated cable 10 m, PVC



104967 CES-A-LSP-10V-104967

✓ Features

- › Optimized for aluminum profile mounting
 - › LED for the indication of the door position
 - › Hard-wired encapsulated cable made of PVC
 - › Cable length 10 m
-

- ✓ Read head CES-A-LNN-...hard-wired encapsulated cable 5 m, PVC



106602 CES-A-LNN-05V-106602

▼ Features

- › Cube-shaped design 42 x 25 mm
 - › Attachment compatible with series CES-A-LNA/LCA
 - › LED for the indication of the door position
 - › Hard-wired encapsulated cable, PVC
 - › Cable length 5 m
-

▼ Read head CES-A-LNN-SC... M8 plug connector



106601 CES-A-LNN-SC-106601

▼ Features

- › Cube-shaped design 42 x 25 mm
 - › Attachment compatible with series CES-A-LNA/LCA
 - › LED for the indication of the door position
 - › With plug connector M8
-

▼ Read head CES-A-LMN-SC, M8 plug connector



077790 CES-A-LMN-SC

▼ Features

- › Cylindrical design M12
 - › M8 plug connector
-

▼ Read head CES-A-LQA-SC, M8 plug connector



095650 CES-A-LQA-SC

▼ Features

- › Cube-shaped design 50 x 50 mm
 - › M8 plug connector
 - › Two safety screws M4x14 included
-

▼ Read head CES-A-LCA..., hard-wired encapsulated cable 10 m, PVC



088785 CES-A-LCA-10V

▼ Features

- › Cube-shaped design 42 x 25 mm
 - › Hard-wired encapsulated cable made of PVC
 - › Cable length 10 m
 - › Two safety screws M4x14 included
-

▼ Read head CES-A-LNA-SC, M8 plug connector



077715 CES-A-LNA-SC

▼ Features

- › Cube-shaped design 42 x 25 mm
 - › With plug connector M8
 - › Two safety screws M4x14 included
-

▼ Read head CES-A-LNA..., hard-wired encapsulated cable 15 m, PUR



084682 CES-A-LNA-15P

✓ Features

- › Cube-shaped design 42 x 25 mm
 - › Hard-wired encapsulated cable made of PUR
 - › Cable length 15 m
 - › Two safety screws M4x14 included
-

✓ Read head CES-A-LNA..., hard-wired encapsulated cable 10 m, PUR



077807 CES-A-LNA-10P

✓ Features

- › Cube-shaped design 42 x 25 mm
 - › Hard-wired encapsulated cable made of PUR
 - › Cable length 10 m
 - › Two safety screws M4x14 included
-

✓ Read head CES-A-LNA..., hard-wired encapsulated cable 5 m, PVC



077806 CES-A-LNA-05P

✓ Features

- › Cube-shaped design 42 x 25 mm
 - › Hard-wired encapsulated cable made of PUR
 - › Cable length 5 m
 - › Two safety screws M4x14 included
-



071845 CES-A-LNA-05V

✓ Features

- › Cube-shaped design 42 x 25 mm
 - › Hard-wired encapsulated cable made of PVC
 - › Cable length 5 m
 - › Two safety screws M4x14 included
-

✓ Read head CES-A-LNA..., hard-wired encapsulated cable 15 m, PVC



071847 CES-A-LNA-15V

✓ Features

- › Cube-shaped design 42 x 25 mm
 - › Hard-wired encapsulated cable made of PVC
 - › Cable length 15 m
 - › Two safety screws M4x14 included
-

✓ Read head CES-A-LNA..., hard-wired encapsulated cable 25 m, PVC



071975 CES-A-LNA-25V

✓ Features

- › Cube-shaped design 42 x 25 mm
 - › Hard-wired encapsulated cable made of PVC
 - › Cable length 25 m
 - › Two safety screws M4x14 included
-

- ✓ Read head CEM-A-LH10R-S3 with guard locking without guard lock monitoring without remanence



095793 CEM-A-LH10R-S3

✓ Features

- › Read head with guard locking without guard lock monitoring
- › Locking force 1000 N
- › Without remanence
- › Up to category 4 according to EN ISO 13849-1

- ✓ Read head CEM-A-LH10K-S3 with guard locking without guard lock monitoring with remanence



095170 CEM-A-LH10K-S3

✓ Features

- › Read head with guard locking without guard lock monitoring
- › Locking force 1000 N
- › With remanence
- › Up to category 4 according to EN ISO 13849-1

- ✓ Read head CEM-A-LE05... with guard locking without guard lock monitoring without remanence



095792 CEM-A-LE05R-S2

✓ Features

- › Read head with guard locking without guard lock monitoring
- › Locking force 650 N
- › Without remanence
- › Up to category 4 according to EN ISO 13849-1
- › Two safety screws M5x16 included

- ✓ Read head CEM-A-LE05... with guard locking without guard lock monitoring with remanence



094800 CEM-A-LE05K-S2

✓ Features

- › Read head with guard locking without guard lock monitoring
- › Locking force 650 N
- › With remanence
- › Up to category 4 according to EN ISO 13849-1
- › Two safety screws M5x16 included

- ✓ Read head CET1-AX-... M12, with guard locking and guard lock monitoring, escape release



102161 CET1-AX-LRA-00-50F-SA

✓ Features

- › Read head with guard locking
- › Locking force up to 6500 N
- › Up to category 4/PL e according to EN ISO 13849-1
- › With plug connector M12
- › 2 LEDs (1 freely configurable)
- › With escape release, 75 mm long
- › Approach direction A (default setting on delivery)

- ✓ Read head CET1-AX-... M12, with guard locking and guard lock monitoring, double insertion

slide



100399 CET1-AX-LDA-00-50X-SE

✓ Features

- › Read head with guard locking
- › Locking force up to 6500 N
- › Up to category 4/PL e according to EN ISO 13849-1
- › With plug connector M12
- › 2 LEDs (1 freely configurable)
- › With double ramp
- › Approach direction A and C (default setting on delivery)

✓ Read head CET1-AX-..., M12, with guard locking and guard lock monitoring



095735 CET1-AX-LRA-00-50X-SA

✓ Features

- › Read head with guard locking
- › Locking force up to 6500 N
- › Up to category 4/PL e according to EN ISO 13849-1
- › With plug connector M12
- › 2 LEDs (1 freely configurable)
- › Approach direction A (default setting on delivery)

✓ Read head CET1-AX-... M12, with guard locking and guard lock monitoring, 2 freely configurable LEDs



104062 CET1-AX-LRA-00-50L-SA

✓ Features

- › Read head with guard locking
- › Locking force up to 6500 N
- › Up to category 4/PL e according to EN ISO 13849-1
- › With plug connector M12
- › 2 LEDs (2 freely configurable)
- › Approach direction A (default setting on delivery)

✓ Read head CES-A-LNA..., hard-wired encapsulated cable 10 m, PVC



071846 CES-A-LNA-10V

✓ Features

- › Cube-shaped design 42 x 25 mm
- › Hard-wired encapsulated cable made of PVC
- › Cable length 10 m
- › Two safety screws M4x14 included

Connection material

✓ Connection kit for evaluation units CES-AZ-.ES-02B, spring terminals

112630 CES-EA-TC-KK06-112630

✓ Features

- › Plug-in spring terminals for evaluation units CCES-AZ-.ES-02B
- › Coded

▼ Connection kit for evaluation units CES-AZ-.ES-02B, screw terminals

104771 CES-EA-TC-AK06-104771

▼ Features

- › Plug-in screw terminals for evaluation units CES-AZ-.ES-02B
- › Coded

Miscellaneous accessories

▼ Inrush current limiting module PM-SCL



096945 PM-SCL-096945

▼ Features

Very high currents are produced on power up if capacitive loads are switched; these currents cause increased wear on electromagnetic switching contacts. The PM-SCL module limits the inrush current for approx. 100 ms and protects the switching contacts.

Instructions

▼ Návod k použití Bezkontaktní bezpečnostní systém CES-AZ-AES-... (Unicode)

	Doc. no.	Version	Language	Download
Betriebsanleitung Berührungsloses Sicherheitssystem CES-AZ-AES-... (Unicode)	2104766	10-09/17		1.8 MB
Mode d'emploi Système de sécurité sans contact CES-AZ-AES-... (Unicode)	2104766	10-09/17		1.8 MB
Manual de instrucciones Sistema de seguridad sin contacto CES-AZ-AES-... (Unicode)	2104766	10-09/17		1.8 MB
Návod k použití Bezkontaktní bezpečnostní systém CES-AZ-AES-... (Unicode)	2104766	10-09/17		1.9 MB
Operating instructions Non-contact safety system CES-AZ-AES-... (Unicode)	2104766	10-09/17		1.8 MB
Istruzioni di impiego Sistema di sicurezza senza contatto CES-AZ-AES-... (Unicode)	2104766	10-09/17		1.8 MB
使用说明书非接触式安全系统 CES-AZ-AES-... (特殊编码)	2104766	10-09/17		2.0 MB









▼ Sicherheitsinformation und Wartung CES-A.../CES-AZ/CES-FD

Doc. no. Version Language Download

Sicherheitsinformation und Wartung CES-A.../CES-AZ/CES-FD	109083	07-04/16	    	 0.5 MB
Información de seguridad y mantenimiento CES-A.../CES-AZ/CES-FD	109083	07-04/16		 0.2 MB
Information de sécurité et entretien CES-A.../CES-AZ/CES-FD	109083	07-04/16		 0.2 MB
Informazioni sulla sicurezza e manutenzione CES-A.../CES-AZ/CES-FD	109083	07-04/16		 0.3 MB
Safety Information and Maintenance CES-A.../CES-AZ/CES-FD	109083	07-04/16		







Catalogs

- Transpondercodierte Sicherheitssysteme mit externer Auswertung Transponder-coded safety systems with external evaluation Sistemas de seguridad con codificación por transponder y evaluación externa Systèmes de sécurité à codage par transpondeur avec analyse externe

	Doc. no.	Version	Language	Download
Transpondercodierte Sicherheitssysteme mit externer Auswertung	127596	02-01/18		 3.1 MB
Systèmes de sécurité à codage par transpondeur avec analyse externe	137968	02-01/18		 3.0 MB
Sistemas de seguridad con codificación por transponder y evaluación externa	139969	02-01/18		 3.0 MB
Transponder-coded safety systems with external evaluation	127597	02-01/18		 3.0 MB

Declaration of conformity

- EU-Konformitätserklärung

	Doc. no.	Version	Language	Download
EU-Konformitätserklärung	2077154	34-01/17	    	 0.5 MB
Declaración UE de conformidad				
Déclaration UE de conformité				
Dichiarazione di conformità				
EU declaration of conformity				

CAD data

CAD data for this item on TraceParts