

## ITEM 077790 CES-A-LMN-SC

Description	Technical data	Accessories	Downloads
-------------	----------------	-------------	-----------

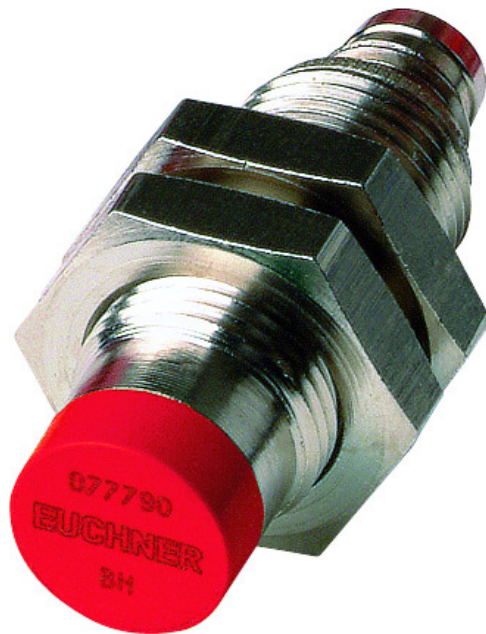

### Features

- › Cylindrical design M12
- › M8 plug connector

**Attention:** The operating distance may vary depending on the background material and installation situation.

**Important:** Actuators must be ordered separately!

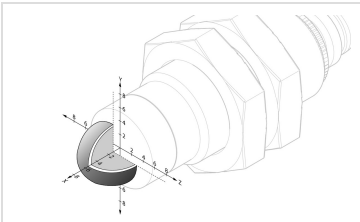

- › Typical operating distance  
A minimum distance of  $s = 1.2 \text{ mm}$  must be maintained.

### Approvals

**Mechanical values and environment**

Housing material		
	Housing sleeve	CuZn nickel-plated
	Cap	Plastic PBT GF20
Weight		
	Net	0,02 kg
Ambient temperature		-25 ... 85 °C
Ambient pressure		
	Only on active face in installed state	max.10 bar
Degree of protection		IP67 / IP69 / IP69K
Installation position		Any
Connection		M8 plug connector, 3-pin
Cable length		
	Maximum allowed	max.15 m
Method of operation		Inductive

**Electrical connection ratings**

Power supply		Via evaluation unit
--------------	--	---------------------

### Dimension drawing

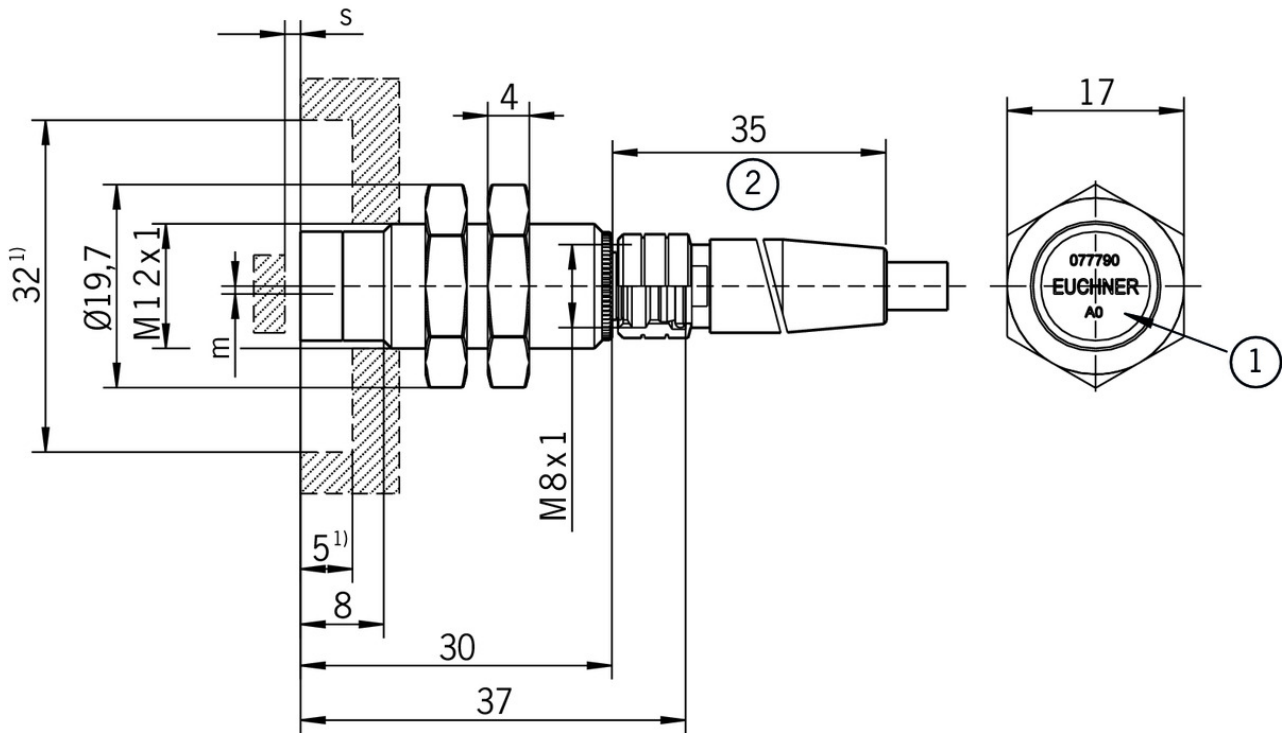

### Legende

- 1 Active face
- 2 In the inserted state
- $s$  Read distance
- $m$  Center offset
- 1) Metal-free zone

### Terminal assignment

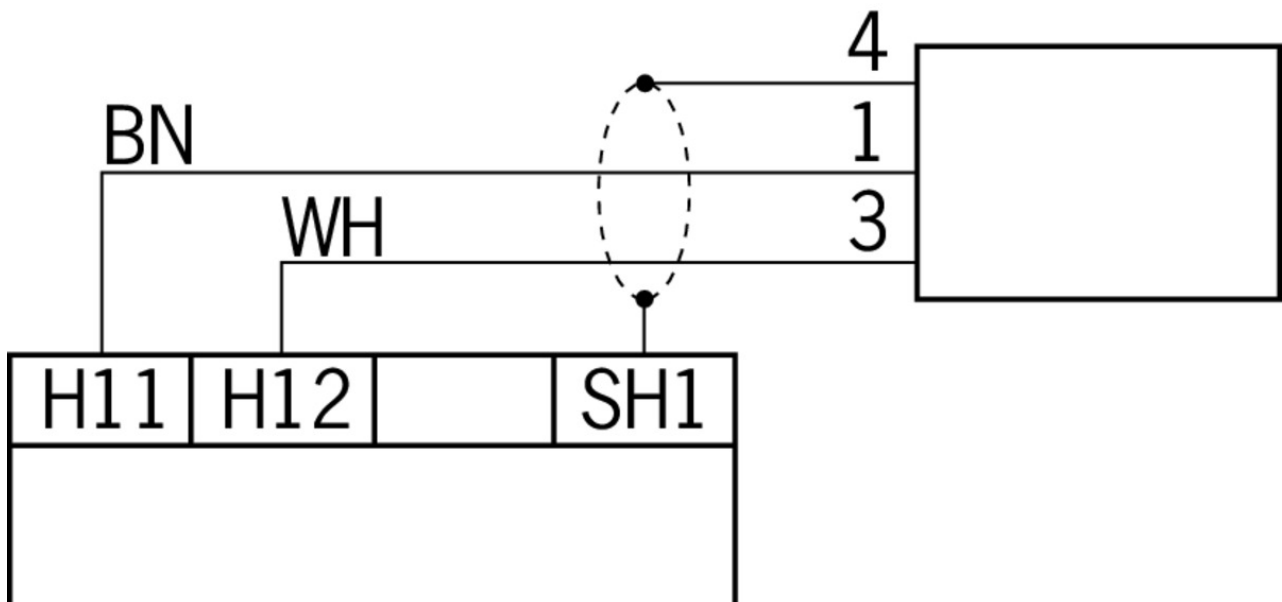

## Connection material

---

- ▼ Connection cable with plug connector M8, 3-pin, 3m



**077935** C-M08F03-02X025PV03,0-ES-077935

- ▼ Features

- › M8 female plug, 3-pin
  - › Straight plug connector
  - › PVC cable
  - › Cable length 3 m
  - › With flying lead
- 

- ▼ Connection cable with plug connector M8, 5m



**077793** C-M08F03-02X025PV05,0-ES-077793

- ▼ Features

- › M8 female plug, 3-pin
  - › Straight plug connector
  - › PVC cable
  - › Cable length 5 m
  - › With flying lead
- 

- ▼ Connection cable with plug connector M8, 3-pin, 10m



**077767** C-M08F03-02X025PV10,0-ES-077767

- ▼ Features

- › M8 female plug, 3-pin
  - › Straight plug connector
  - › PVC cable
  - › Cable length 10 m
  - › With flying lead
- 



**084763** C-M08F03-02X025PU10,0-ES-084763

- ▼ Features

- › M8 female plug, 3-pin
  - › Straight plug connector
  - › PUR cable
  - › Cable length 10 m
  - › With flying lead
- 

- ▼ Connection cable with plug connector M8, 3-pin, 20m



**077716** C-M08F03-02X025PV20,0-ES-077716

- ▼ Features

- › M8 female plug, 3-pin
  - › Straight plug connector
  - › PVC cable
  - › Cable length 20 m
  - › With flying lead
- 

**084765** C-M08F03-02X025PU20,0-ES-084765



- ✓ Features
    - › M8 female plug, 3-pin
    - › Straight plug connector
    - › PUR cable
    - › Cable length 20 m
    - › With flying lead
- 

✓ Connection cable with plug connector M8, 3-pin, 25m



**077717** C-M08F03-02X025PV25,0-ES-077717

- ✓ Features
    - › M8 female plug, 3-pin
    - › Straight plug connector
    - › PVC cable
    - › Cable length 25 m
    - › With flying lead
- 



**084766** C-M08F03-02X025PU25,0-ES-084766

- ✓ Features
    - › M8 female plug, 3-pin
    - › Straight plug connector
    - › PUR cable
    - › Cable length 25 m
    - › With flying lead
- 

✓ Connection cable with plug connector M8, 3-pin, 5m



**084762** C-M08F03-02X025PU05,0-ES-084762

- ✓ Features
    - › M8 female plug, 3-pin
    - › Straight plug connector
    - › PUR cable
    - › Cable length 5 m
    - › With flying lead
- 

✓ Connection cable with plug connector M8, 3-pin, 15m



**084764** C-M08F03-02X025PU15,0-ES-084764

- ✓ Features
    - › M8 female plug, 3-pin
    - › Straight plug connector
    - › PUR cable
    - › Cable length 15 m
    - › With flying lead
- 

✓ Connection cable with angled plug connector M8, 3-pin, 10m



**084701** C-M08F03-02X025PV10,0-ES-084701

- ✓ Features
  - › M8 female plug, 3-pin
  - › Angled plug connector
  - › PVC cable

- › Cable length 10 m
- › With flying lead



**098590** C-M08F03-02X025PU10,0-ES-098590

▣ Features

- › M8 female plug, 3-pin
- › Angled plug connector
- › PUR cable
- › Cable length 10 m
- › With flying lead

▣ Connection cable with angled plug connector M8, 3-pin, 25m, angled



**099998** C-M08F03-02X025PV25,0-ES-099998

▣ Features

- › M8 female plug, 3-pin
- › Angled plug connector
- › PVC cable
- › Cable length 25 m
- › With flying lead

## Actuator

▣ Actuator CES-A-BMB



**077791** CES-A-BMB

▣ Features

- › Cylindrical design M12 x 0.75

## Mounting accessories

▣ Insertion tool for actuator CES-A-BMB



**037662** EINDREHWERKZEUG

## Instructions

▣ Návod k použití Bezkontaktní bezpečnostní systém CES-AZ-AES-... (Unicode)

	Doc. no.	Version	Language	Download
Betriebsanleitung Berührungsloses Sicherheitssystem CES-AZ-AES-... (Unicode)	2104766	10-09/17		1.8 MB
Mode d'emploi Système de sécurité sans contact CES-AZ-AES-... (Unicode)	2104766	10-09/17		1.8 MB









Manual de instrucciones Sistema de seguridad sin contacto CES-AZ-AES-... (Unicode)	2104766	10-09/17		 1.8 MB
Návod k použití Bezkontaktní bezpečnostní systém CES-AZ-AES-... (Unicode)	2104766	10-09/17		 1.9 MB
Operating instructions Non-contact safety system CES-AZ-AES-... (Unicode)	2104766	10-09/17		 1.8 MB
Istruzioni di impiego Sistema di sicurezza senza contatto CES-AZ-AES-... (Unicode)	2104766	10-09/17		 1.8 MB
使用说明书非接触式安全系统 CES-AZ-AES-... (特殊编码)	2104766	10-09/17		 2.0 MB

 **Návod k použití Bezkontaktní bezpečnostní systém CES-AZ-UES-... (Multicode)**

	<b>Doc. no.</b>	<b>Version</b>	<b>Language</b>	<b>Download</b>
Betriebsanleitung Berührungsloses Sicherheitssystem CES-AZ-UES-... (Multicode)	2105274	09-09/17		 1.8 MB
Mode d'emploi Système de sécurité sans contact CES-AZ-UES-... (Multicode)	2105274	09-09/17		 1.8 MB
Manual de instrucciones Sistema de seguridad sin contacto CES-AZ-UES-... (Multicode)	2105274	09-09/17		 1.8 MB
Návod k použití Bezkontaktní bezpečnostní systém CES-AZ-UES-... (Multicode)	2105274	09-09/17		 1.9 MB
Operating instructions Non-contact safety system CES-AZ-UES-... (Multicode)	2105274	09-09/17		 1.8 MB
Istruzioni di impiego Sistema di sicurezza senza contatto CES-AZ-UES-... (Multicode)	2105274	09-09/17		 1.8 MB
使用说明书非接触式安全系统 CES-AZ-UES-... (通用编码)	2105274	09-09/17		 2.0 MB



## Catalogs

 **Transpondercodierte Sicherheitssysteme mit externer Auswertung Transponder-coded safety systems with external evaluation Sistemas de seguridad con codificación por transponder y evaluación externa Systèmes de sécurité à codage par transpondeur avec analyse externe**

	<b>Doc. no.</b>	<b>Version</b>	<b>Language</b>	<b>Download</b>
Transpondercodierte Sicherheitssysteme mit externer Auswertung	127596	02-01/18		 3.1 MB
Systèmes de sécurité à codage par transpondeur avec analyse externe	137968	02-01/18		 3.0 MB
Sistemas de seguridad con codificación por transponder y evaluación externa	139969	02-01/18		 3.0 MB
Transponder-coded safety systems with external evaluation	127597	02-01/18		 3.0 MB





## Application example

 **Anschluss CES-FD an MURR MVK-MPNIO**





	<b>Doc. no.</b>	<b>Version</b>	<b>Language</b>	<b>Download</b>
Anschluss CES-FD an MURR MVK-MPNIO	AP000177	03-03/15		 0.3 MB

Connection of CES-FD to MURR MVK-MPNIO	AP000177	03-03/15		 0.3 MB
--	----------	----------	--	---

▼ Anschluss CES-FD an Siemens ET 200pro







	Doc. no.	Version	Language	Download
Anschluss CES-FD an Siemens ET 200pro	AP000155	04-03/15		 0.3 MB
Connection of CES-FD to Siemens ET 200pro	AP000155	04-03/15		 0.3 MB

▼ Anschluss CES-FD-AP an Siemens ET 200S

	Doc. no.	Version	Language	Download
Anschluss CES-FD-AP an Siemens ET 200S	AP000154	03-03/15		 0.3 MB
Connection of CES-FD-AP to Siemens ET 200S	AP000154	03-03/15		 0.3 MB

## Declaration of conformity

▼ EU-Konformitätserklärung

	Doc. no.	Version	Language	Download
EU-Konformitätserklärung	2077154	34-01/17		 0.5 MB
EU declaration of conformity				
Declaración UE de conformidad				
Déclaration UE de conformité				
Dichiarazione di conformità				

## CAD data

CAD data for this item on TraceParts