

ITEM 077806 CES-A-LNA-05P

Description	Technical data	Accessories	Downloads
-------------	----------------	-------------	-----------



Features

- › Cube-shaped design 42 x 25 mm
- › Hard-wired encapsulated cable made of PUR
- › Cable length 5 m
- › Two safety screws M4x14 included

Housing material

Fortron, reinforced thermoplastic, fully encapsulated.

Attention: The operating distance may vary depending on the background material and installation situation.

Important: Actuators must be ordered separately!

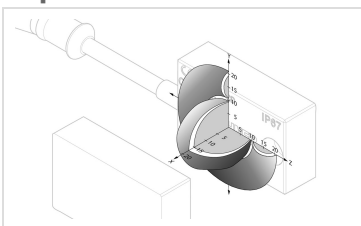

› Typical operating distance

For a side approach direction for the actuator and read head, a minimum distance of $s = 3$ mm must be maintained so that the operating distance of the side lobes is not entered.

Approvals



Mechanical values and environment

Housing material	Reinforced thermoplastic (PPS), fully encapsulated
Weight	Net 0,3 kg ^[1]
Ambient temperature	
Cable dynamic	-5 ... 70 °C
Cable static	-25 ... 70 °C
Degree of protection	IP67/IP69K
Installation position	Any
Tightening torque	
Fixing screws	max.1 Nm
Connection	Hard-wired encapsulated connection cable
Cable length	
Maximum allowed	max.25 m
Method of operation	Inductive

Electrical connection ratings

Power supply	Via evaluation unit
Connecting cable	PUR (suitable for drag chain), length 5m, Ø 4.1...5.3 mm, with crimped ferrules

^[1] (Incl 10m cable)

Dimension drawing

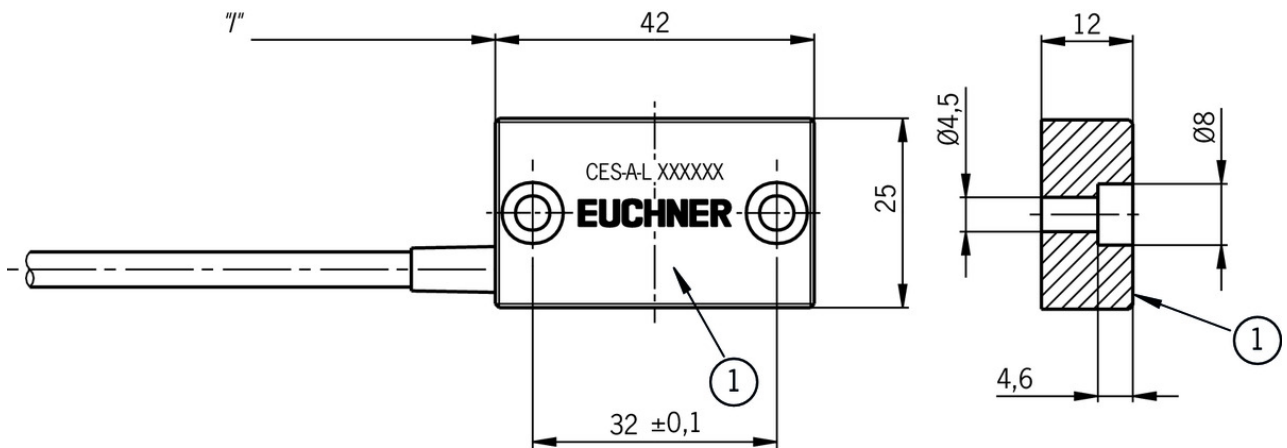

Legende

1 Active face

Terminal assignment

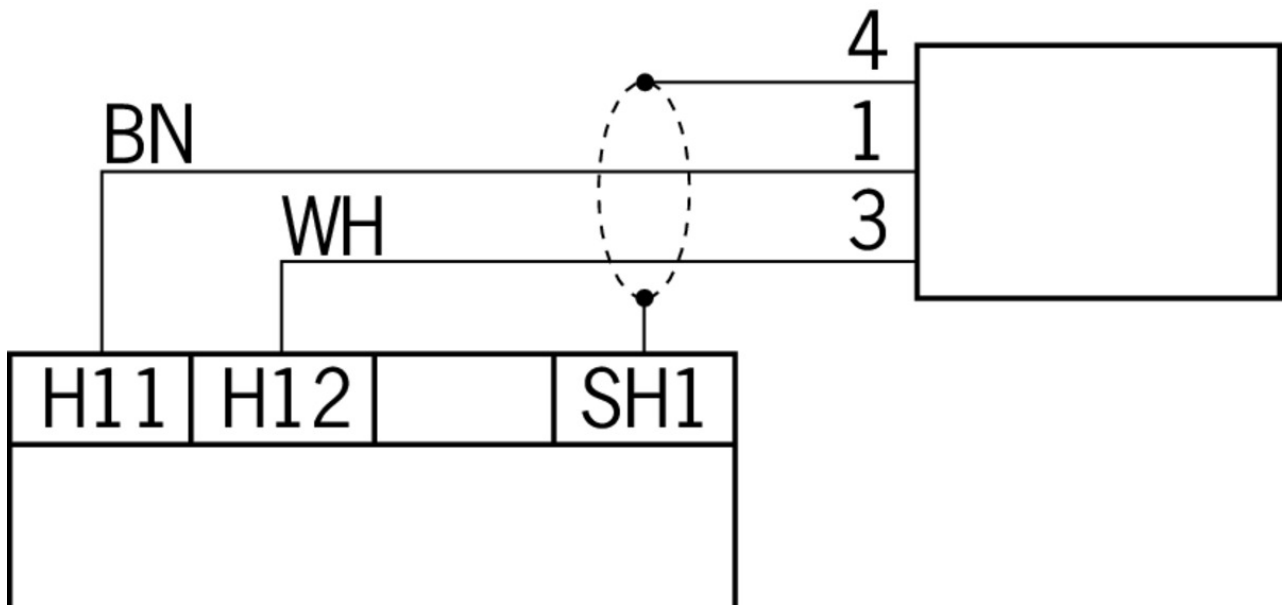

Mounting accessories

☑ Safety screws M4 x 14

071863 M4X14-CES/V20

☑ Features

- › Safety screws M4 x 14
- › Packaging unit 20 pieces

Actuator

Actuator CES-A-BBA



071840 CES-A-BBA

Features

- › Cube-shaped design 42 x 25 mm
 - › Two safety screws M4x14 included
-

Actuator CES-A-BCA



088786 CES-A-BCA

Features

- › Cube-shaped design 42 x 25 mm
 - › Two safety screws M4x14 included
-

Actuator CES-A-BDA



084720 CES-A-BDA-20

Features

- › Round design \varnothing 20 mm
-



156935 CES-A-BDA-18-156935

Features

- › For safety switches CES-C01 and read heads CES-A-LNA
 - › Round design \varnothing 18 mm
 - › For use in applications in very confined spaces
 - › Mounting on metal is permissible
 - › Flush mounting is permissible only in plastic
-

Bolt

Bolt CES-A-A



076487 RIEGEL CES-A-A

Features

- › Steel bolt
 - › In combination with read head CES-A-LNA...
 - › For left or right hinged doors
 - › Ball detent mechanism in closed position
 - › Can be locked in open position with padlocks
 - › Actuator included
-

Bolt CES-A-A/F with escape release



086173 RIEGEL CES-A-A/F















Features

- › Steel bolt
- › In combination with read head CES-A-LNA...
- › For doors hinged on the right or left
- › Lever for escape release from the danger area

- › Detent knob in open position
- › Ball detent mechanism in closed position
- › Can be locked in open position with padlocks
- › Actuator included

Instructions

▼ Návod k použití Bezkontaktní bezpečnostní systém CES-AZ-AES-... (Unicode)









	Doc. no.	Version	Language	Download
Betriebsanleitung Berührungsloses Sicherheitssystem CES-AZ-AES-... (Unicode)	2104766	10-09/17		 1.8 MB
Mode d'emploi Système de sécurité sans contact CES-AZ-AES-... (Unicode)	2104766	10-09/17		 1.8 MB
Manual de instrucciones Sistema de seguridad sin contacto CES-AZ-AES-... (Unicode)	2104766	10-09/17		 1.8 MB
Návod k použití Bezkontaktní bezpečnostní systém CES-AZ-AES-... (Unicode)	2104766	10-09/17		 1.9 MB
Operating instructions Non-contact safety system CES-AZ-AES-... (Unicode)	2104766	10-09/17		 1.8 MB
Istruzioni di impiego Sistema di sicurezza senza contatto CES-AZ-AES-... (Unicode)	2104766	10-09/17		 1.8 MB
使用说明书非接触式安全系统 CES-AZ-AES-... (特殊编码)	2104766	10-09/17		 2.0 MB

▼ Návod k použití Bezkontaktní bezpečnostní systém CES-AZ-UES-... (Multicode)

	Doc. no.	Version	Language	Download
Betriebsanleitung Berührungsloses Sicherheitssystem CES-AZ-UES-... (Multicode)	2105274	09-09/17		 1.8 MB
Mode d'emploi Système de sécurité sans contact CES-AZ-UES-... (Multicode)	2105274	09-09/17		 1.8 MB
Manual de instrucciones Sistema de seguridad sin contacto CES-AZ-UES-... (Multicode)	2105274	09-09/17		 1.8 MB
Návod k použití Bezkontaktní bezpečnostní systém CES-AZ-UES-... (Multicode)	2105274	09-09/17		 1.9 MB
Operating instructions Non-contact safety system CES-AZ-UES-... (Multicode)	2105274	09-09/17		 1.8 MB
Istruzioni di impiego Sistema di sicurezza senza contatto CES-AZ-UES-... (Multicode)	2105274	09-09/17		 1.8 MB
使用说明书非接触式安全系统 CES-AZ-UES-... (通用编码)	2105274	09-09/17		 2.0 MB







Catalogs

- ▼ Transpondercodierte Sicherheitssysteme mit externer Auswertung Transponder-coded safety systems with external evaluation Sistemas de seguridad con codificación por transponder y evaluación externa Systèmes de sécurité à codage par transpondeur avec analyse externe

	Doc. no.	Version	Language	Download
Transpondercodierte Sicherheitssysteme mit externer Auswertung	127596	02-01/18		 3.1 MB
Systèmes de sécurité à codage par transpondeur avec analyse externe	137968	02-01/18		 3.0 MB
Sistemas de seguridad con codificación por transponder y evaluación externa	139969	02-01/18		 3.0 MB
Transponder-coded safety systems with external evaluation	127597	02-01/18		 3.0 MB

Declaration of conformity

EU-Konformitätserklärung

	Doc. no.	Version	Language	Download
EU-Konformitätserklärung EU declaration of conformity Declaración UE de conformidad Déclaration UE de conformité Dichiarazione di conformità	2077154	34-01/17	    	 0.5 MB

CAD data

CAD data for this item on TraceParts