

## ITEM 095650 CES-A-LQA-SC

Description	Technical data	Accessories	Downloads
-------------	----------------	-------------	-----------



### Features

- › Cube-shaped design 50 x 50 mm
- › M8 plug connector
- › Two safety screws M4x14 included

**Attention:** The operating distance may vary depending on the background material and installation situation.

**Important:** Actuators must be ordered separately!

### On evaluation unit with standard operating distance

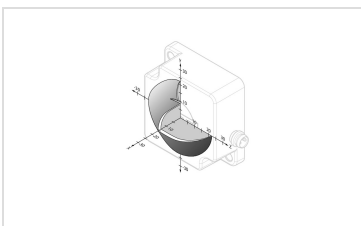

- › Typical operating distance  
With actuator CES-A-BBA or CES-A-BCA

### On evaluation unit CES-AZ-...-01B with standard operating distance

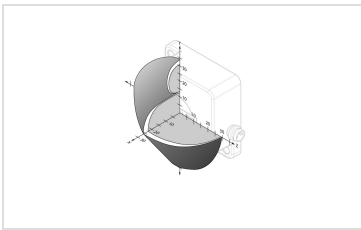

► Figure  
With actuator CES-A-BQA

## Approvals



## Mechanical values and environment

Housing material	Plastic PPS
Weight	Net 0,08 kg <sup>[1]</sup>
Ambient temperature	-25 ... 70 °C
Degree of protection	IP67
Installation position	Any
Tightening torque	Fixing screws max.1 Nm
Connection	M8 plug connector, 3-pin
Cable length	Maximum allowed max.25 m
Method of operation	Inductive

## Electrical connection ratings

Power supply	Via evaluation unit
--------------	---------------------

[1] (Without connection cable)

**Dimension drawing**

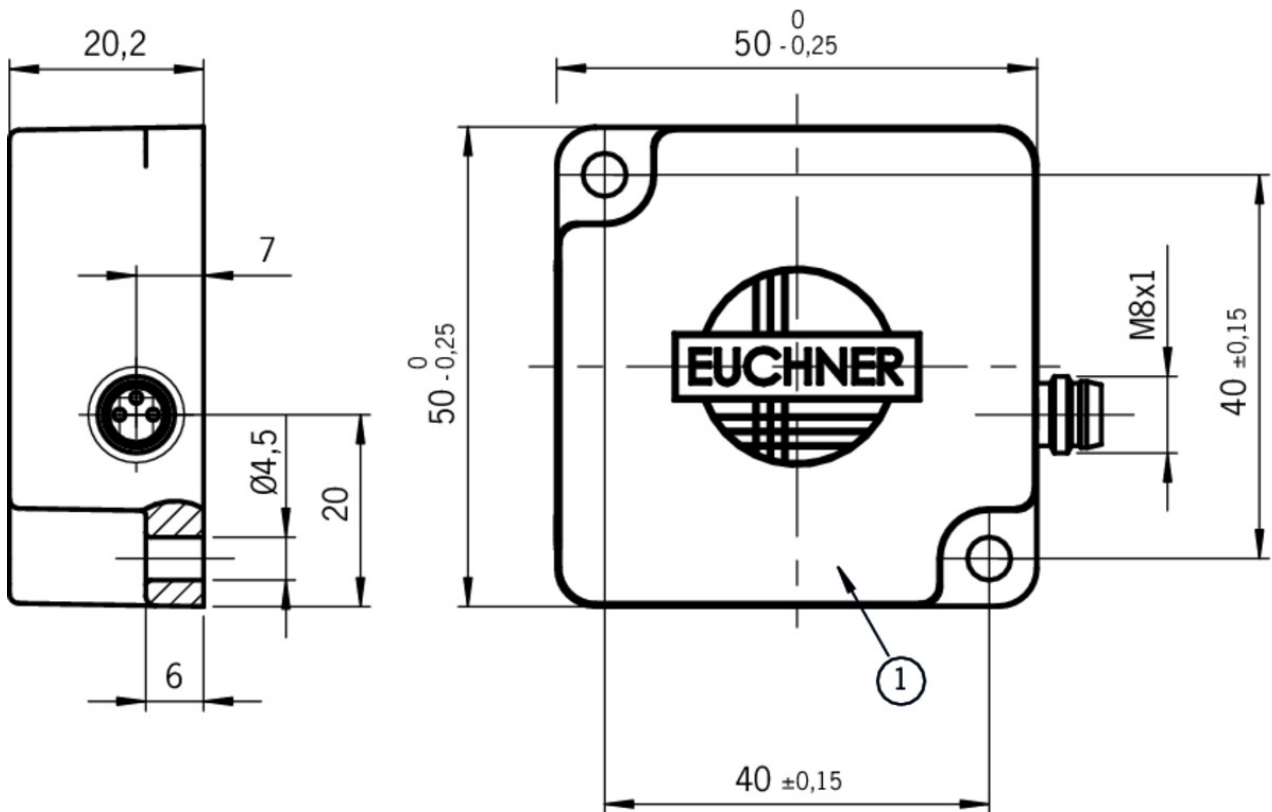

**Legende**

1 Active face

**Terminal assignment**

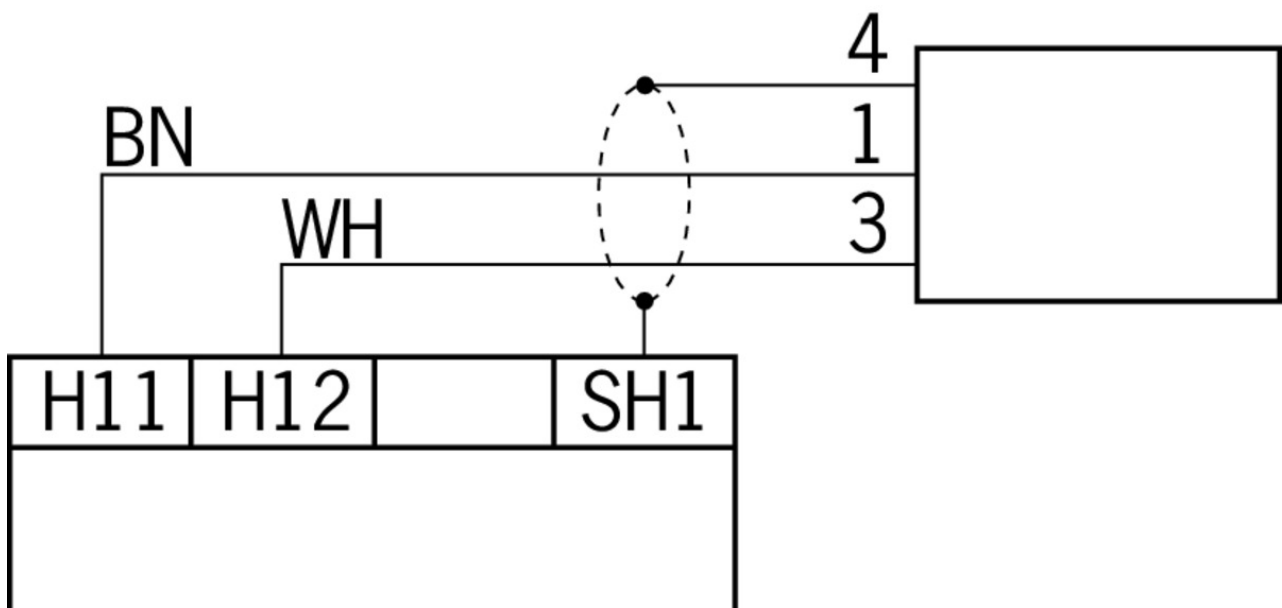

## Connection material

---

- ▼ Connection cable with angled plug connector M8, 3-pin, 25m, angled



**099998** C-M08F03-02X025PV25,0-ES-099998

- ▼ Features

- › M8 female plug, 3-pin
  - › Angled plug connector
  - › PVC cable
  - › Cable length 25 m
  - › With flying lead
- 

- ▼ Connection cable with angled plug connector M8, 3-pin, 10m



**084701** C-M08F03-02X025PV10,0-ES-084701

- ▼ Features

- › M8 female plug, 3-pin
  - › Angled plug connector
  - › PVC cable
  - › Cable length 10 m
  - › With flying lead
- 



**098590** C-M08F03-02X025PU10,0-ES-098590

- ▼ Features

- › M8 female plug, 3-pin
  - › Angled plug connector
  - › PUR cable
  - › Cable length 10 m
  - › With flying lead
- 

- ▼ Connection cable with plug connector M8, 3-pin, 20m



**084765** C-M08F03-02X025PU20,0-ES-084765

- ▼ Features

- › M8 female plug, 3-pin
  - › Straight plug connector
  - › PUR cable
  - › Cable length 20 m
  - › With flying lead
- 



**077716** C-M08F03-02X025PV20,0-ES-077716

- ▼ Features

- › M8 female plug, 3-pin
  - › Straight plug connector
  - › PVC cable
  - › Cable length 20 m
  - › With flying lead
- 

- ▼ Connection cable with plug connector M8, 3-pin, 25m

**084766** C-M08F03-02X025PU25,0-ES-084766



- ▼ Features
    - › M8 female plug, 3-pin
    - › Straight plug connector
    - › PUR cable
    - › Cable length 25 m
    - › With flying lead
- 



**077717** C-M08F03-02X025PV25,0-ES-077717

- ▼ Features
    - › M8 female plug, 3-pin
    - › Straight plug connector
    - › PVC cable
    - › Cable length 25 m
    - › With flying lead
- 

▼ Connection cable with plug connector M8, 5m



**077793** C-M08F03-02X025PV05,0-ES-077793

- ▼ Features
    - › M8 female plug, 3-pin
    - › Straight plug connector
    - › PVC cable
    - › Cable length 5 m
    - › With flying lead
- 

▼ Connection cable with plug connector M8, 3-pin, 3m



**077935** C-M08F03-02X025PV03,0-ES-077935

- ▼ Features
    - › M8 female plug, 3-pin
    - › Straight plug connector
    - › PVC cable
    - › Cable length 3 m
    - › With flying lead
- 

▼ Connection cable with plug connector M8, 3-pin, 10m



**077767** C-M08F03-02X025PV10,0-ES-077767

- ▼ Features
    - › M8 female plug, 3-pin
    - › Straight plug connector
    - › PVC cable
    - › Cable length 10 m
    - › With flying lead
- 



**084763** C-M08F03-02X025PU10,0-ES-084763

- ▼ Features
  - › M8 female plug, 3-pin
  - › Straight plug connector
  - › PUR cable
  - › Cable length 10 m
  - › With flying lead

- 
- ▼ Connection cable with plug connector M8, 3-pin, 5m



**084762** C-M08F03-02X025PU05,0-ES-084762

▼ Features

- › M8 female plug, 3-pin
- › Straight plug connector
- › PUR cable
- › Cable length 5 m
- › With flying lead

- 
- ▼ Connection cable with plug connector M8, 3-pin, 15m



**084764** C-M08F03-02X025PU15,0-ES-084764

▼ Features

- › M8 female plug, 3-pin
- › Straight plug connector
- › PUR cable
- › Cable length 15 m
- › With flying lead

- 
- ▼ Connection cable with plug connector M8, 3-pin, 50m



**077718** C-M08F03-02X025PV50,0-ES-077718

▼ Features

- › M8 female plug, 3-pin
- › Straight plug connector
- › PVC cable
- › Cable length 50 m
- › With flying lead



**084767** C-M08F03-02X025PU50,0-ES-084767

▼ Features

- › M8 female plug, 3-pin
- › Straight plug connector
- › PUR cable
- › Cable length 50 m
- › With flying lead

---

## Actuator

- ▼ Actuator CES-A-BQA



**098108** CES-A-BQA

▼ Features

- › Cube-shaped design 50 x 50 mm
- › Two safety screws M4x14 included

- 
- ▼ Actuator CES-A-BBA

**071840** CES-A-BBA



- ▼ Features
  - › Cube-shaped design 42 x 25 mm
  - › Two safety screws M4x14 included

▼ Actuator CES-A-BCA



- 088786** CES-A-BCA
- ▼ Features
    - › Cube-shaped design 42 x 25 mm
    - › Two safety screws M4x14 included

## Mounting accessories

▼ Safety screws M4 x 14

- 071863** M4X14-CES/V20
- ▼ Features
    - › Safety screws M4 x 14
    - › Packaging unit 20 pieces

## Instructions

▼ Návod k použití Bezkontaktní bezpečnostní systém CES-AZ-AES-... (Unicode)

	Doc. no.	Version	Language	Download
Betriebsanleitung Berührungsloses Sicherheitssystem CES-AZ-AES-... (Unicode)	2104766	10-09/17		1.8 MB
Mode d'emploi Système de sécurité sans contact CES-AZ-AES-... (Unicode)	2104766	10-09/17		1.8 MB
Manual de instrucciones Sistema de seguridad sin contacto CES-AZ-AES-... (Unicode)	2104766	10-09/17		1.8 MB
Návod k použití Bezkontaktní bezpečnostní systém CES-AZ-AES-... (Unicode)	2104766	10-09/17		1.9 MB
Operating instructions Non-contact safety system CES-AZ-AES-... (Unicode)	2104766	10-09/17		1.8 MB
Istruzioni di impiego Sistema di sicurezza senza contatto CES-AZ-AES-... (Unicode)	2104766	10-09/17		1.8 MB
使用说明书非接触式安全系统 CES-AZ-AES-... (特殊编码)	2104766	10-09/17		2.0 MB









▼ Návod k použití Bezkontaktní bezpečnostní systém CES-AZ-UES-... (Multicode)

	Doc. no.	Version	Language	Download
Betriebsanleitung Berührungsloses Sicherheitssystem CES-AZ-UES-... (Multicode)	2105274	09-09/17		1.8 MB

Mode d'emploi Système de sécurité sans contact CES-AZ-UES-... (Multicode)	2105274	09-09/17		 1.8 MB
Manual de instrucciones Sistema de seguridad sin contacto CES-AZ-UES-... (Multicode)	2105274	09-09/17		 1.8 MB
Návod k použití Bezkontaktní bezpečnostní systém CES-AZ-UES-... (Multicode)	2105274	09-09/17		 1.9 MB
Operating instructions Non-contact safety system CES-AZ-UES-... (Multicode)	2105274	09-09/17		 1.8 MB
Istruzioni di impiego Sistema di sicurezza senza contatto CES-AZ-UES-... (Multicode)	2105274	09-09/17		 1.8 MB
使用说明书非接触式安全系统 CES-AZ-UES-... (通用编码)	2105274	09-09/17		 2.0 MB







## Catalogs

- Transpondercodierte Sicherheitssysteme mit externer Auswertung Transponder-coded safety systems with external evaluation Sistemas de seguridad con codificación por transponder y evaluación externa Systèmes de sécurité à codage par transpondeur avec analyse externe

	Doc. no.	Version	Language	Download
Transpondercodierte Sicherheitssysteme mit externer Auswertung	127596	02-01/18		 3.1 MB
Systèmes de sécurité à codage par transpondeur avec analyse externe	137968	02-01/18		 3.0 MB
Sistemas de seguridad con codificación por transponder y evaluación externa	139969	02-01/18		 3.0 MB
Transponder-coded safety systems with external evaluation	127597	02-01/18		 3.0 MB

## Declaration of conformity

- EU-Konformitätserklärung

	Doc. no.	Version	Language	Download
EU-Konformitätserklärung EU declaration of conformity Declaración UE de conformidad Déclaration UE de conformité Dichiarazione di conformità	2077154	34-01/17	    	 0.5 MB

## CAD data

CAD data for this item on TraceParts