

ITEM 106601 CES-A-LNN-SC-106601

Description	Technical data	Accessories	Downloads
-------------	----------------	-------------	-----------



Features

- › Cube-shaped design 42 x 25 mm
- › Attachment compatible with series CES-A-LNA/LCA
- › LED for the indication of the door position
- › With plug connector M8

Attention: The operating distance may vary depending on the background material and installation situation.

Important: Actuators must be ordered separately!

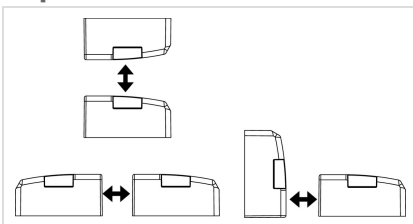

› Approach directions

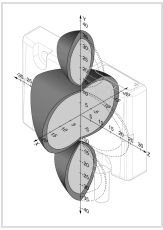

► Typical operating distance

For a side approach direction for the actuator and read head, a minimum distance of $s = 6 \text{ mm}$ must be maintained so that the operating distance of the side lobes is not entered.

Approvals



Mechanical values and environment

Housing material	Reinforced thermoplastic (PBT), fully encapsulated
Weight	Net 0,025 kg
Ambient temperature	-25 ... 70 °C
Degree of protection	IP67
Installation position	Any
Tightening torque	Fixing screws max.1 Nm
Connection	M8 plug connector, 3-pin
Cable length	Maximum allowed max.25 m
Method of operation	Inductive

Electrical connection ratings

Power supply	Via evaluation unit
LED indicator	White: valid actuator detected

Dimension drawing

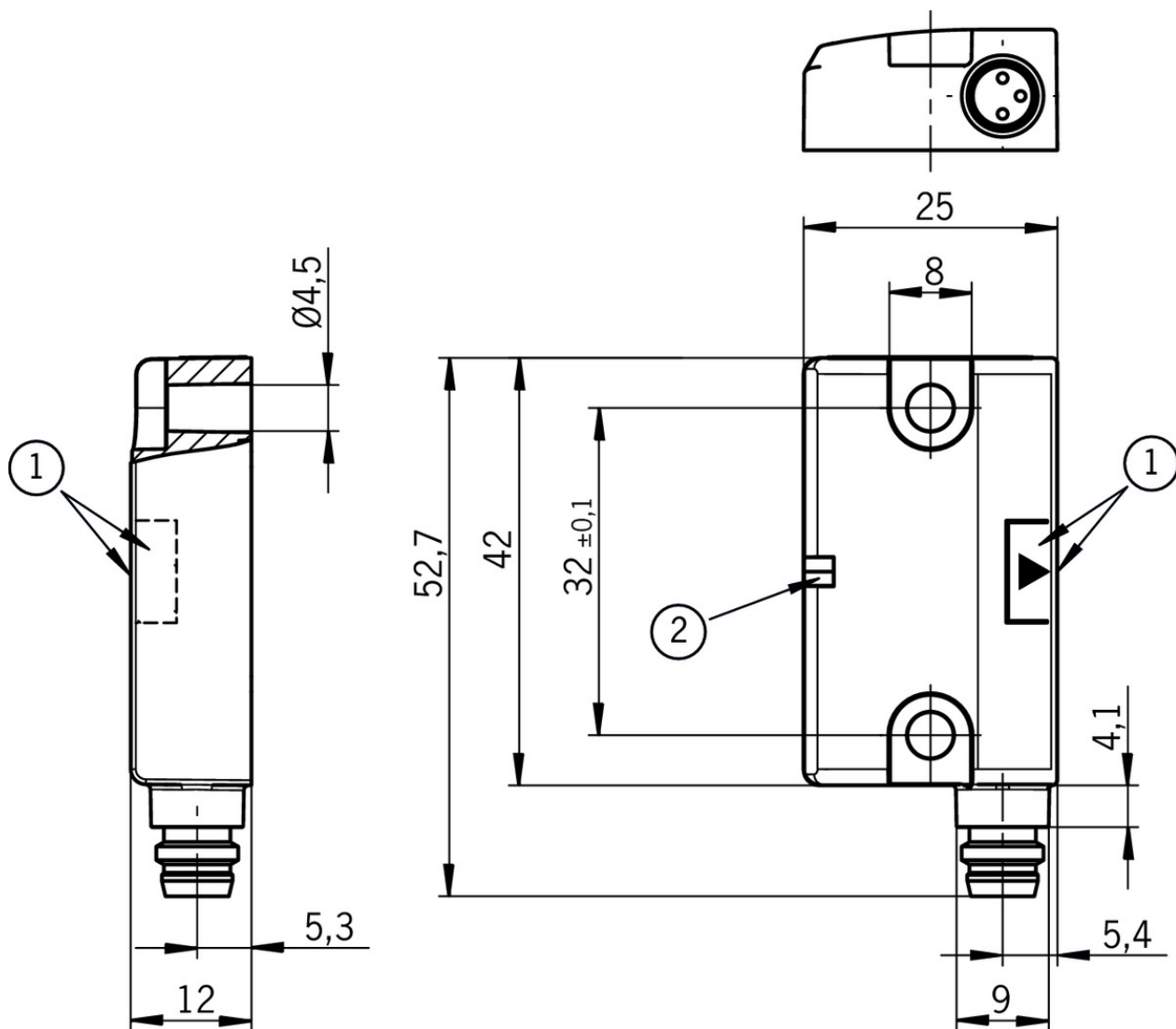

Legende

- 1 Active face
- 2 LED

Terminal assignment

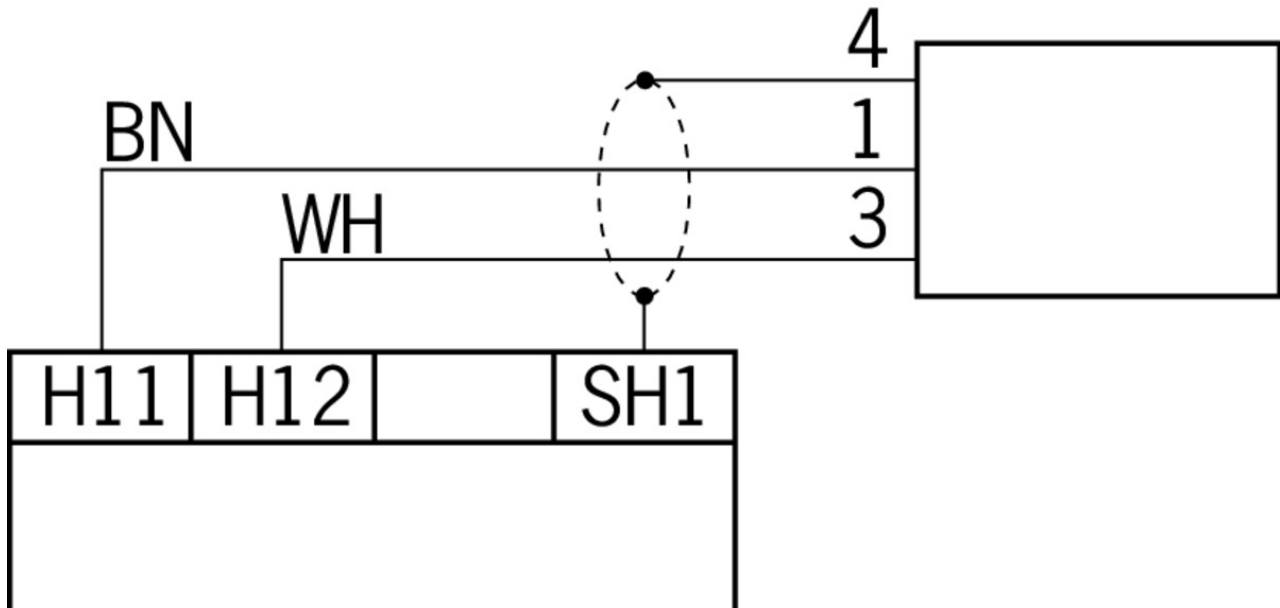

Connection material

- Connection cable with plug connector M8, 3-pin, 20m



084765 C-M08F03-02X025PU20,0-ES-084765

Features

- › M8 female plug, 3-pin
- › Straight plug connector
- › PUR cable
- › Cable length 20 m
- › With flying lead



077716 C-M08F03-02X025PV20,0-ES-077716

Features

- › M8 female plug, 3-pin
- › Straight plug connector
- › PVC cable
- › Cable length 20 m
- › With flying lead

- Connection cable with plug connector M8, 3-pin, 10m



084763 C-M08F03-02X025PU10,0-ES-084763

Features

- › M8 female plug, 3-pin
- › Straight plug connector
- › PUR cable
- › Cable length 10 m
- › With flying lead



077767 C-M08F03-02X025PV10,0-ES-077767

Features

- › M8 female plug, 3-pin
 - › Straight plug connector
 - › PVC cable
 - › Cable length 10 m
 - › With flying lead
-

▼ Connection cable with plug connector M8, 3-pin, 15m



084764 C-M08F03-02X025PU15,0-ES-084764

▼ Features

- › M8 female plug, 3-pin
 - › Straight plug connector
 - › PUR cable
 - › Cable length 15 m
 - › With flying lead
-

▼ Connection cable with plug connector M8, 3-pin, 25m



084766 C-M08F03-02X025PU25,0-ES-084766

▼ Features

- › M8 female plug, 3-pin
 - › Straight plug connector
 - › PUR cable
 - › Cable length 25 m
 - › With flying lead
-



077717 C-M08F03-02X025PV25,0-ES-077717

▼ Features

- › M8 female plug, 3-pin
 - › Straight plug connector
 - › PVC cable
 - › Cable length 25 m
 - › With flying lead
-

▼ Connection cable with angled plug connector M8, 3-pin, 10m



084701 C-M08F03-02X025PV10,0-ES-084701

▼ Features

- › M8 female plug, 3-pin
 - › Angled plug connector
 - › PVC cable
 - › Cable length 10 m
 - › With flying lead
-



098590 C-M08F03-02X025PU10,0-ES-098590

▼ Features

- › M8 female plug, 3-pin
 - › Angled plug connector
 - › PUR cable
 - › Cable length 10 m
 - › With flying lead
-

▼ Connection cable with plug connector M8, 3-pin, 3m



077935 C-M08F03-02X025PV03,0-ES-077935

▼ Features

- › M8 female plug, 3-pin
 - › Straight plug connector
 - › PVC cable
 - › Cable length 3 m
 - › With flying lead
-

▼ Connection cable with plug connector M8, 5m



077793 C-M08F03-02X025PV05,0-ES-077793

▼ Features

- › M8 female plug, 3-pin
 - › Straight plug connector
 - › PVC cable
 - › Cable length 5 m
 - › With flying lead
-

▼ Connection cable with plug connector M8, 3-pin, 5m



084762 C-M08F03-02X025PU05,0-ES-084762

▼ Features

- › M8 female plug, 3-pin
 - › Straight plug connector
 - › PUR cable
 - › Cable length 5 m
 - › With flying lead
-

▼ Connection cable with angled plug connector M8, 3-pin, 25m, angled



099998 C-M08F03-02X025PV25,0-ES-099998

▼ Features

- › M8 female plug, 3-pin
 - › Angled plug connector
 - › PVC cable
 - › Cable length 25 m
 - › With flying lead
-

▼ Connection cable with plug connector M8, 3-pin, 50m



077718 C-M08F03-02X025PV50,0-ES-077718

▼ Features

- › M8 female plug, 3-pin
 - › Straight plug connector
 - › PVC cable
 - › Cable length 50 m
 - › With flying lead
-



084767 C-M08F03-02X025PU50,0-ES-084767

▼ Features

- › M8 female plug, 3-pin
- › Straight plug connector
- › PUR cable
- › Cable length 50 m
- › With flying lead

Actuator

Actuator CES-A-BBN



106600 CES-A-BBN-106600

Features

- › Cube-shaped design 42 x 25 mm
- › Attachment compatible with actuator CES-A-BBA/BCA

Actuator CES-A-BDN-06



104730 CES-A-BDN-06-104730

Features

- › Cylindrical design Ø 6 mm

Mounting accessories

Safety screws M4 x 14

071863 M4X14-CES/V20

Features

- › Safety screws M4 x 14
- › Packaging unit 20 pieces

Instructions

Návod k použití Bezkontaktní bezpečnostní systém CES-AZ-AES-... (Unicode)

	Doc. no.	Version	Language	Download
Betriebsanleitung Berührungsloses Sicherheitssystem CES-AZ-AES-... (Unicode)	2104766	10-09/17		1.8 MB
Mode d'emploi Système de sécurité sans contact CES-AZ-AES-... (Unicode)	2104766	10-09/17		1.8 MB
Manual de instrucciones Sistema de seguridad sin contacto CES-AZ-AES-... (Unicode)	2104766	10-09/17		1.8 MB
Návod k použití Bezkontaktní bezpečnostní systém CES-AZ-AES-... (Unicode)	2104766	10-09/17		1.9 MB









Operating instructions Non-contact safety system CES-AZ-AES-... (Unicode)	2104766	10-09/17		 1.8 MB
Istruzioni di impiego Sistema di sicurezza senza contatto CES-AZ-AES-... (Unicode)	2104766	10-09/17		 1.8 MB
使用说明书非接触式安全系统 CES-AZ-AES-... (特殊编码)	2104766	10-09/17		 2.0 MB

 **Návod k použití Bezkontaktní bezpečnostní systém CES-AZ-UES-... (Multicode)**

	Doc. no.	Version	Language	Download
Betriebsanleitung Berührungsloses Sicherheitssystem CES-AZ-UES-... (Multicode)	2105274	09-09/17		 1.8 MB
Mode d'emploi Système de sécurité sans contact CES-AZ-UES-... (Multicode)	2105274	09-09/17		 1.8 MB
Manual de instrucciones Sistema de seguridad sin contacto CES-AZ-UES-... (Multicode)	2105274	09-09/17		 1.8 MB
Návod k použití Bezkontaktní bezpečnostní systém CES-AZ-UES-... (Multicode)	2105274	09-09/17		 1.9 MB
Operating instructions Non-contact safety system CES-AZ-UES-... (Multicode)	2105274	09-09/17		 1.8 MB
Istruzioni di impiego Sistema di sicurezza senza contatto CES-AZ-UES-... (Multicode)	2105274	09-09/17		 1.8 MB
使用说明书非接触式安全系统 CES-AZ-UES-... (通用编码)	2105274	09-09/17		 2.0 MB







Catalogs

 **Transpondercodierte Sicherheitssysteme mit externer Auswertung Transponder-coded safety systems with external evaluation Sistemas de seguridad con codificación por transponder y evaluación externa Systèmes de sécurité à codage par transpondeur avec analyse externe**

	Doc. no.	Version	Language	Download
Transpondercodierte Sicherheitssysteme mit externer Auswertung	127596	02-01/18		 3.1 MB
Systèmes de sécurité à codage par transpondeur avec analyse externe	137968	02-01/18		 3.0 MB
Sistemas de seguridad con codificación por transponder y evaluación externa	139969	02-01/18		 3.0 MB
Transponder-coded safety systems with external evaluation	127597	02-01/18		 3.0 MB

Declaration of conformity

 **EU-Konformitätserklärung**

	Doc. no.	Version	Language	Download
EU-Konformitätserklärung EU declaration of conformity Declaración UE de conformidad Déclaration UE de conformité Dichiarazione di conformità	2077154	34-01/17	    	 0.5 MB

CAD data

