

ITEM 095170 CEM-A-LH10K-S3

Description	Technical data	Accessories	Downloads
-------------	----------------	-------------	-----------



Features

- › Read head with guard locking without guard lock monitoring
- › Locking force 1000 N
- › With remanence
- › Up to category 4 according to EN ISO 13849-1

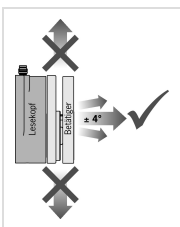

› Approach direction

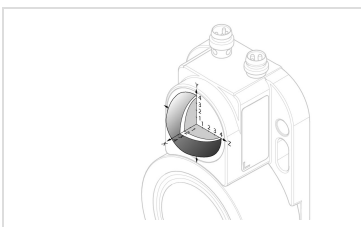

› Typical operating distance

Note assured switch-off distance $s_{ar} = 20$ mm for internal component failure.
 Safety outputs are reliably switched off.

Approvals



Mechanical values and environment

Material	Solenoid	Steel, nickel-plated
Housing material		Die-cast aluminum
Read head material		Plastic (PPS)
Weight	Net	0,9 kg
Ambient temperature		-25 ... 50 °C
Degree of protection		IP67
Mechanical life		
In case of use as door stop, and 1 Joule impact energy		1×10^6
Installation position		Any
Switching frequency	Read head	See operating instructions for the related evaluation unit ^[1]
	Solenoid	max.1 Hz
Connection		
X2, external LED		Plug connector M8x1, 4-pin female (with screw terminal)
X1, solenoid (yellow LED integrated in the plug)		Plug connector M8x1, 4-pin male (with snap-action / screw terminal)
X3, read head		Plug connector M8x1, 3-pin male (with snap-action / screw terminal)
Cable length		max.25 m
Guard locking principle		Open-circuit current principle
Locking force F		
(Not monitored, in axial direction) at $U_{CM} \geq 24V$		1000 N
Adhesive force		
due to remanence		40 -25% ... +25% N

Electrical connection ratings

Operating voltage DC	U_{CM}	24 V DC -15% ... 10%
Current consumption	U_B	225 mA

Circuit diagram connection solenoid operating voltage plug S1. A free-wheeling diode is already integrated into each CEM.

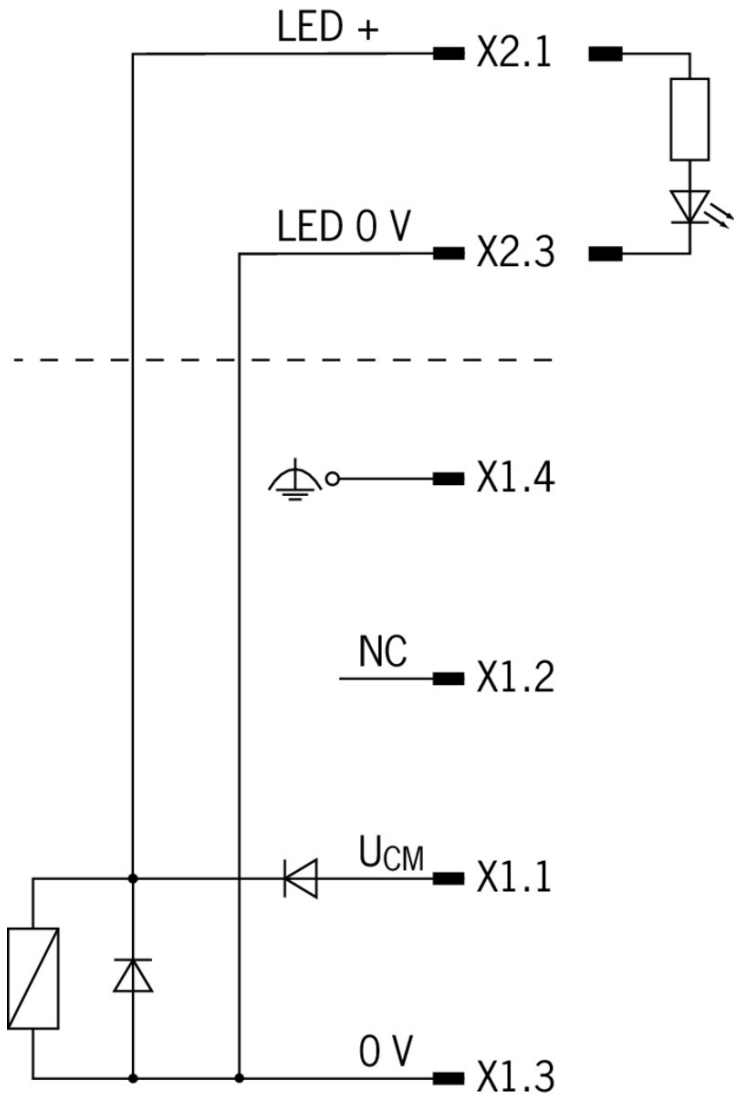

Wiring diagram

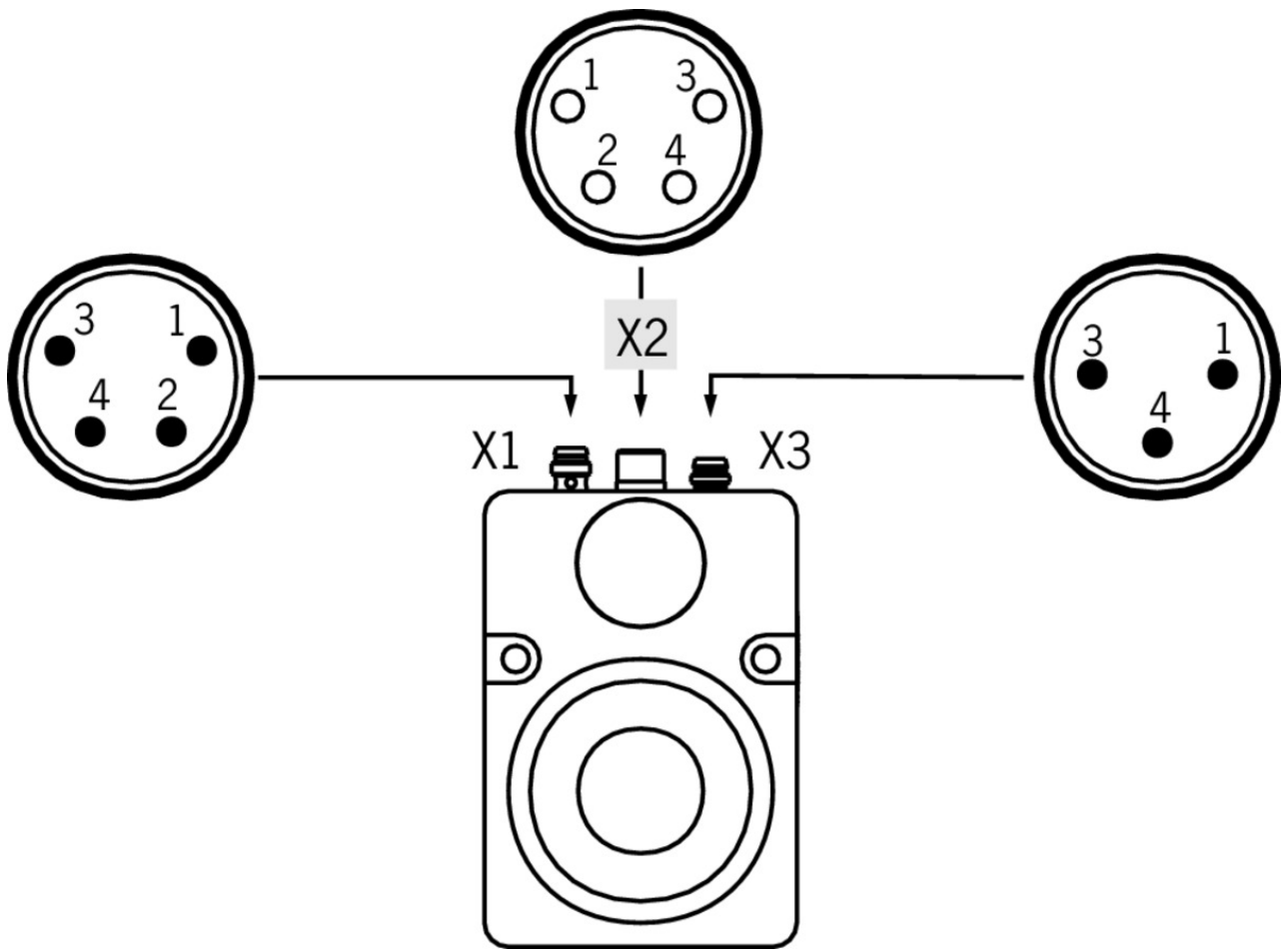

Legende

Solenoid operating voltage

X1.1 U_{CM}/DC 24 V

X1.2 NC

X1.3 0 V/GND

X1.4 Function earth

External LED indicator connection

X2.1 LED +

X2.2 -

X2.3 LED 0 V

X2.4 -

Evaluation unit CES

X3.1 Data line

X3.3 Data line

X3.4 SH (screen)

Connection material

▼ Connection cable with plug connector M8, 3-pin, 3m



077935 C-M08F03-02X025PV03,0-ES-077935

▼ Features

- › M8 female plug, 3-pin
- › Straight plug connector
- › PVC cable
- › Cable length 3 m
- › With flying lead

▼ Connection cable with plug connector M8, 5m



077793 C-M08F03-02X025PV05,0-ES-077793

▼ Features

- › M8 female plug, 3-pin
- › Straight plug connector
- › PVC cable
- › Cable length 5 m
- › With flying lead

▼ Connection cable with plug connector M8, 3-pin, 10m



077767 C-M08F03-02X025PV10,0-ES-077767

▼ Features

- › M8 female plug, 3-pin
- › Straight plug connector
- › PVC cable
- › Cable length 10 m
- › With flying lead



084763 C-M08F03-02X025PU10,0-ES-084763

▼ Features

- › M8 female plug, 3-pin
- › Straight plug connector
- › PUR cable
- › Cable length 10 m
- › With flying lead

▼ Connection cable with plug connector M8, 3-pin, 25m



077717 C-M08F03-02X025PV25,0-ES-077717

▼ Features

- › M8 female plug, 3-pin
- › Straight plug connector
- › PVC cable
- › Cable length 25 m
- › With flying lead



084766 C-M08F03-02X025PU25,0-ES-084766

▼ Features

- › M8 female plug, 3-pin
- › Straight plug connector

- › PUR cable
 - › Cable length 25 m
 - › With flying lead
-

▼ Connection cable with plug connector M8, 3-pin, 5m



084762 C-M08F03-02X025PU05,0-ES-084762

▼ Features

- › M8 female plug, 3-pin
 - › Straight plug connector
 - › PUR cable
 - › Cable length 5 m
 - › With flying lead
-

▼ Connection cable with plug connector M8, 3-pin, 20m



077716 C-M08F03-02X025PV20,0-ES-077716

▼ Features

- › M8 female plug, 3-pin
 - › Straight plug connector
 - › PVC cable
 - › Cable length 20 m
 - › With flying lead
-



084765 C-M08F03-02X025PU20,0-ES-084765

▼ Features

- › M8 female plug, 3-pin
 - › Straight plug connector
 - › PUR cable
 - › Cable length 20 m
 - › With flying lead
-

▼ Connection cable with plug connector M8, 3-pin, 15m



084764 C-M08F03-02X025PU15,0-ES-084764

▼ Features

- › M8 female plug, 3-pin
 - › Straight plug connector
 - › PUR cable
 - › Cable length 15 m
 - › With flying lead
-

▼ Connection cable with angled plug connector M8, 3-pin, 25m, angled



099998 C-M08F03-02X025PV25,0-ES-099998

▼ Features

- › M8 female plug, 3-pin
 - › Angled plug connector
 - › PVC cable
 - › Cable length 25 m
 - › With flying lead
-

▼ Connection cable with angled plug connector M8, 3-pin, 10m



098590 C-M08F03-02X025PU10,0-ES-098590

▼ Features

- › M8 female plug, 3-pin
 - › Angled plug connector
 - › PUR cable
 - › Cable length 10 m
 - › With flying lead
-



084701 C-M08F03-02X025PV10,0-ES-084701

▼ Features

- › M8 female plug, 3-pin
 - › Angled plug connector
 - › PVC cable
 - › Cable length 10 m
 - › With flying lead
-

▼ Connection cable with plug connector M8, 4-pin, 5m



088813 C-M08F04-04X025PV05,0-ES-088813

▼ Features

- › M8 female plug, 4-pin
 - › Straight plug connector
 - › PVC cable
 - › Cable length 5 m
 - › With flying lead
-



088842 C-M08M04-04X025PV05,0-ES-088842

▼ Features

- › M8 female plug, 4-pin
 - › Straight plug connector
 - › PVC cable
 - › Cable length 5 m
 - › With flying lead
-



116049 C-M08F04-04X034PU05,0-ES-116049

▼ Features

- › M8 female plug, 4-pin
 - › Straight plug connector
 - › PUR cable
 - › Cable length 5 m
 - › With flying lead
-

▼ Connection cable with plug connector M8, 4-pin, 10m



088814 C-M08F04-04X025PV10,0-ES-088814

▼ Features

- › M8 female plug, 4-pin
- › Straight plug connector
- › PVC cable
- › Cable length 10 m

- › With flying lead



088843 C-M08M04-04X025PV10,0-ES-088843

▣ Features

- › M8 female plug, 4-pin
- › Straight plug connector
- › PVC cable
- › Cable length 10 m
- › With flying lead



116050 C-M08F04-04X034PU10,0-ES-116050

▣ Features

- › M8 female plug, 4-pin
- › Straight plug connector
- › PUR cable
- › Cable length 10 m
- › With flying lead

▣ Connection cable with plug connector M8, 4-pin, 15m



088815 C-M08F04-04X025PV15,0-ES-088815

▣ Features

- › M8 female plug, 4-pin
- › Straight plug connector
- › PVC cable
- › Cable length 15 m
- › With flying lead



088844 C-M08M04-04X025PV15,0-ES-088844

▣ Features

- › M8 female plug, 4-pin
- › Straight plug connector
- › PVC cable
- › Cable length 15 m
- › With flying lead

▣ Connection cable with plug connector M8, 4-pin, 25m



095035 C-M08F04-04X025PV25,0-ES-095035

▣ Features

- › M8 female plug, 4-pin
- › Straight plug connector
- › PVC cable
- › Cable length 25 m
- › With flying lead

▣ Connection cable with angled plug connector M8, 4-pin, 10m



084703 C-M08F04-04X025PV10,0-ES-084703

▣ Features

- › M8 female plug, 4-pin
- › Angled plug connector

- › PVC cable
- › Cable length 10 m
- › With flying lead

☑ Connection cable with plug connector M8, 4-pin, 2m



088841 C-M08M04-04X025PV02,0-ES-088841

☑ Features

- › M8 female plug, 4-pin
- › Straight plug connector
- › PVC cable
- › Cable length 2 m
- › With flying lead

☑ Connection cable with plug connector M8, 4-pin, 20m



116051 C-M08F04-04X034PU20,0-ES-116051

☑ Features

- › M8 female plug, 4-pin
- › Straight plug connector
- › PUR cable
- › Cable length 20 m
- › With flying lead

Actuator

☑ Actuator CEM-A-BH10



095175 CEM-A-BH10

☑ Features

- › Locking force 1000 N
- › Two safety screws M5x16 included









Instructions

☑ Betriebsanleitung Leseköpfe/Betätiger CEM-A-...

	Doc. no.	Version	Language	Download
Betriebsanleitung Leseköpfe/Betätiger CEM-A-...	2114342	07-04/18		1.3 MB
Operating Instructions Read Heads/Actuators				
CEM-A-...				
Manual de instrucciones Cabeza de lectura/actuador CEM-A-...				
Mode d'emploi Têtes de lecture/actionneurs CEM-A-...				
Istruzioni di impiego Testine di lettura/azionatori CEM-A-...				







Catalogs

- ▼ Transpondercodierte Sicherheitssysteme mit externer Auswertung Transponder-coded safety systems with external evaluation Sistemas de seguridad con codificación por transponder y evaluación externa Systèmes de sécurité à codage par transpondeur avec analyse externe

	Doc. no.	Version	Language	Download
Transpondercodierte Sicherheitssysteme mit externer Auswertung	127596	02-01/18		 3.1 MB
Systèmes de sécurité à codage par transpondeur avec analyse externe	137968	02-01/18		 3.0 MB
Sistemas de seguridad con codificación por transponder y evaluación externa	139969	02-01/18		 3.0 MB
Transponder-coded safety systems with external evaluation	127597	02-01/18		 3.0 MB

Declaration of conformity

- ▼ EU-Konformitätserklärung

	Doc. no.	Version	Language	Download
EU-Konformitätserklärung Declaración UE de conformidad Déclaration UE de conformité Dichiarazione di conformità EU declaration of conformity	2077154	34-01/17	    	 0.5 MB

CAD data

CAD data for this item on TraceParts