

**ITEM 111917 CET1-AX-LRA-00-50X-SA-C2333-111917**

Description	Technical data	Accessories	Downloads
-------------	----------------	-------------	-----------



**Features**

- › Read head with guard locking
- › Locking force up to 6500 N
- › Up to category 4/PL e according to EN ISO 13849-1
- › With plug connector M12
- › With lockout bar
- › 2 LEDs (1 freely configurable)
- › Approach direction A (default setting on delivery)

**Approach direction**

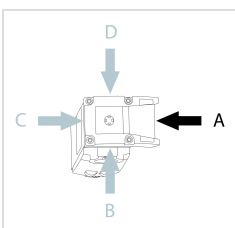

› Figure

Horizontal

Can be adjusted in 90° steps

## Lockout bar

The lockout bar can be used to prevent maintenance personnel from being unintentionally locked in the danger area, for example.

**Important:** The lockout bar is not a safety function.

This device with lockout mechanism possesses no auxiliary release.

---

## Solenoid operating voltage

› DC 24 V +10% -15%

---

## Guard locking type

**CET1 Closed-circuit current principle**, guard locking by spring force.

Release by applying voltage to the guard locking solenoid.

---

## LED function display

**LED rot** illuminates when solenoid is switched on

**LED grün** freely configurable

---

## Category according to EN ISO 13849-1

**Important:** The category in accordance with EN ISO 13849-1 is dependent on the evaluation unit used and on the installation position.

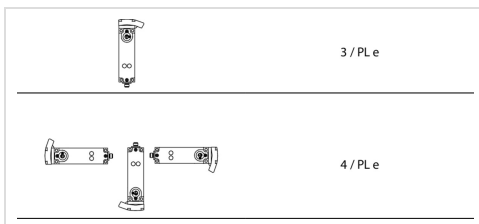

› Figure

---

## Notes

- › Special connection cables from EUCHNER are required for the connection. Please take into account in the order!
- › The device may be operated only in conjunction with the actuator CET-A-.... The actuator must be ordered separately.

---

## Approvals



---

## Mechanical values and environment

Housing material

Slide Stainless steel

	Safety switch	Die-cast aluminum
Weight	Net	1 kg
Ambient temperature	At $U_B = 24V$ DC	-20 ... 55 °C
Degree of protection		IP67 <b>[1]</b>
Mechanical life		$1 \times 10^6$
Installation position		Any <b>[2]</b>
Degree of freedom	X	$\pm 5$ mm
	Y	$\pm 5$ mm
	Z	$\pm 4$ mm
Switching frequency		1 Hz <b>[3]</b>
Connection		1 plug connector M12, 8-pin
Approach speed		20 m/min
Guard locking principle		Closed-circuit current principle
Locking force $F_{max}$		6500 N
Locking force $F_{Zh}$		5000 N

### Electrical connection ratings

Operating voltage DC	LED	24 V DC -15% ... 15% Reverse polarity protected
Current consumption	$I_{CM}$	480 mA Solenoid
	LED	max.6 mA
Solenoid operating voltage DC	$U_{CM}$	24 V DC -15% ... +10% Reverse polarity protected, regulated, residual ripple < 5%, PELV
Rated insulation voltage $U_i$		50 V
Rated impulse withstand voltage $U_{imp}$		1,5 kV
Power consumption	Solenoid	12 W
Solenoid duty cycle		100 %
Degree of contamination (external, according to EN 60947-1)		3
Safety class	EN IEC 61140	III

### Miscellaneous

C number	C2333	With lockout mechanism mounted
----------	-------	--------------------------------

[1] With screwed tight plug connector

[2] Preferably head downward

[3] This value can vary depending on the evaluation unit used. See system documentation of the related evaluation unit.

### Dimension drawing

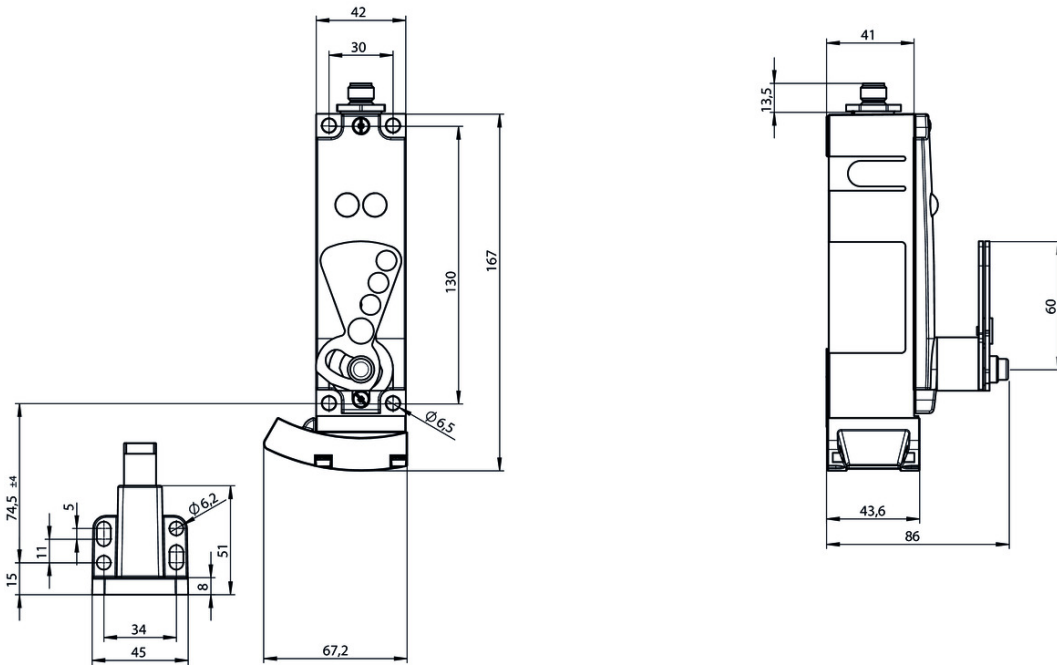
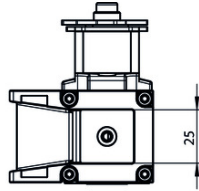

## Block diagram

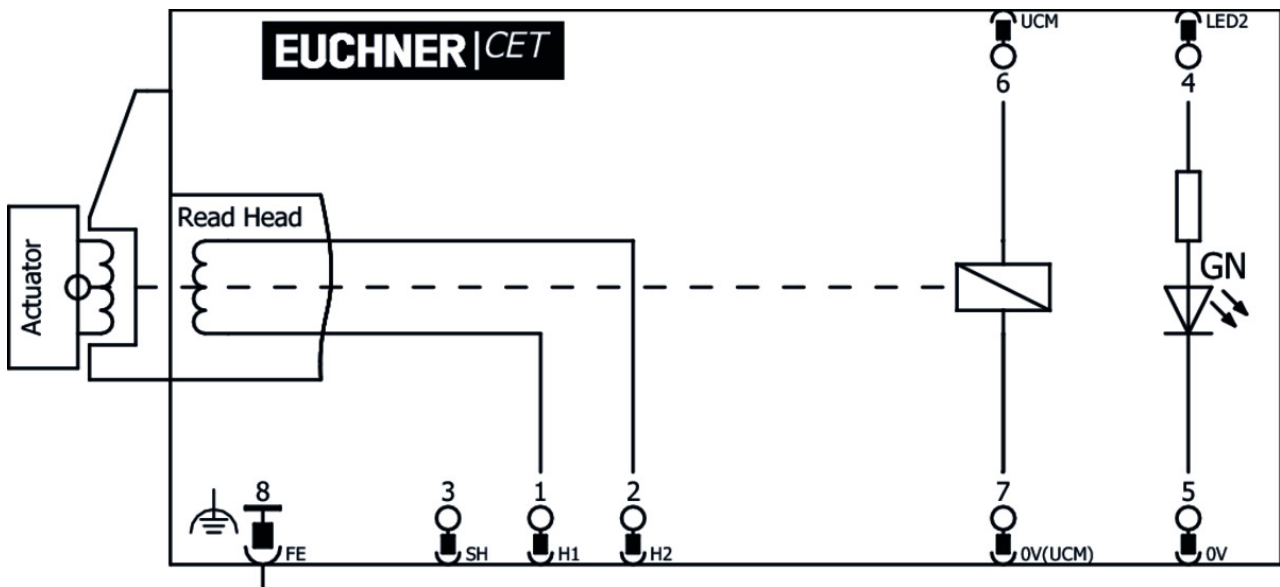

## Function expansion

### Cover for read head and actuator CET



#### **098808** CET ABDECKUNG RECHTS

##### Features

- › Cover for read heads / safety switches CET and actuators CET
- › For approach direction A



#### **098807** CET ABDECKUNG LINKS

##### Features

- › Cover for read heads / safety switches CET and actuators CET
- › For approach direction C

### Double ramp for safety switch/read head CET



#### **114091** CET-DR

### Cover for actuator CET



#### **124979** AM-C-124979

##### Features

- › Cover for actuator CET
- › Horizontal and vertical fastening option on the actuator
- › Mounting using 4 screws M5x16 (included with the actuator)
- › Not suitable in combination with lockout bar for actuator CET

### Lockout mechanism for CET actuator



#### **122609** AE-L-CET-122609

✔ Features

- › Prevents unintentional closing of the door
  - › Can be secured with padlocks
  - › Not suitable in combination with cover AM-C for actuator CET
- 

## Connection material

---

✔ Connection cable with plug connector M12, 8-pin, 10m



**102218** C-M12F08-07X025PU10,0-MA-102218

✔ Features

- › M12 female plug, 8-pin
  - › Straight plug connector
  - › PUR cable
  - › Cable length 10 m
  - › With flying lead
- 



**099633** C-M12F08-07X025PV10,0-MA-099633

✔ Features

- › M12 female plug, 8-pin
  - › Straight plug connector
  - › PVC cable
  - › Cable length 10 m
  - › With flying lead
- 

✔ Connection cable with plug connector M12, 8-pin, 25m



**103782** C-M12F08-07X025PU25,0-MA-103782

✔ Features

- › M12 female plug, 8-pin
  - › Straight plug connector
  - › PUR cable
  - › Cable length 25 m
  - › With flying lead
- 



**103115** C-M12F08-07X025PV25,0-MA-103115

✔ Features

- › M12 female plug, 8-pin
  - › Straight plug connector
  - › PVC cable
  - › Cable length 25 m
  - › With flying lead
- 

✔ Connection cable with angled plug connector M12, 8-pin, 10m



**100456** C-M12F08-07X025PV10,0-MA-100456

✔ Features

- › M12 female plug, 8-pin
- › Angled plug connector
- › PVC cable
- › Cable length 10 m

- › With flying lead

- ▼ Connection cable with angled plug connector M12, 8-pin, 20m



**105071** C-M12F08-07X025PV20,0-MA-105071

▼ Features

- › M12 female plug, 8-pin
- › Angled plug connector
- › PVC cable
- › Cable length 20 m
- › With flying lead

- ▼ Connection cable with plug connector M12, 8-pin, 20m



**099634** C-M12F08-07X025PV20,0-MA-099634

▼ Features

- › M12 female plug, 8-pin
- › Straight plug connector
- › PVC cable
- › Cable length 20 m
- › With flying lead

## Actuator

- ▼ Actuator CET-A-BWK-50X



**096327** CET-A-BWK-50X

▼ Features

- › Actuator for read head/safety switch CET
- › Four safety screws M5x16 included

## Mounting accessories

- ▼ Mounting plate EMP-L-... for CET read head/switches



**106695** EMP-L-CET

▼ Features

- › Mounting plate for CET read heads/switches
- › For hinged or sliding doors
- › Suitable for aluminum profiles 40 ... 45 mm
- › Horizontal and vertical mounting
- › Suitable for CET with escape release

- ▼ Mounting plate EM-P switch for safety switch CET



**126399** AM-P-126399

▼ Features

- › Mounting plate for CET read heads/switches
- › Direct mounting on aluminum profiles of width 30/40/50 mm

- › Suitable for the mounting plates AM-P-126400 and AM-P-126398

---

▼ Mounting plate EM-P actuator for safety switch CET



**126400** AM-P-126400

▼ Features

- › Mounting plate for CET actuator
- › Suitable for mounting on aluminum profiles of width 30/40/50 mm
- › Suitable for the mounting plates AM-P-126399 and AM-P-126398

---

▼ Mounting plate EM-P handle for safety switch CET



**126398** AM-P-126398

▼ Features

- › Mounting plate with handle (handle included)
- › For hinged or sliding doors
- › Horizontal and vertical assembly circuits possible
- › Suitable for aluminum profiles of width 30/40/50 mm
- › Suitable for the CET mounting plates AM-P-126399 and AM-P-126400

---

## Bolt

▼ Bolt CET-A-C



**104309** RIEGEL CET-A-C

▼ Features

- › Steel bolt
- › In combination with CET
- › For left or right hinged doors
- › Can be locked in open position with padlocks



**109672** RIEGEL CET-A-C-C2308

▼ Features

- › Steel bolt
- › In combination with CET
- › For left or right hinged doors
- › Can be locked in open position with padlocks
- › Bolt without door stop, suitable for swing doors

---

## Instructions

▼ Manual de instrucciones Cabeza de lectura CET-AX con bloqueo y monitorización de bloqueo







**Doc. no.** **Version** **Language** **Download**



Betriebsanleitung Lesekopf CET-AX mit Zuhaltung und Zuhaltungsüberwachung Operating Instructions Read Head CET-AX with Guard Locking and Guard Lock Monitoring	2098069	18-07/17	 	 2.0 MB
Mode d'emploi Tête de lecture CET-AX avec interverrouillage et contrôle de verrouillage	2098069	18-07/17		 1.1 MB
Manual de instrucciones Cabeza de lectura CET- AX con bloqueo y monitorización de bloqueo	2098069	18-07/17		 1.1 MB
Istruzioni di impiego, Testina di lettura CET-AX con meccanismo di ritenuta e controllo del meccanismo di ritenuta	2098069	18-07/17		 1.1 MB

## Declaration of conformity

 EU-Konformitätserklärung

	Doc. no.	Version	Language	Download
EU-Konformitätserklärung Declaración UE de conformidad Déclaration UE de conformité Dichiarazione di conformità EU declaration of conformity	2077154	34-01/17	    	 0.5 MB

## CAD data

CAD data for this item on TraceParts