

ITEM 106548 ESH-ARO-20A-1205

Description	Technical data	Accessories	Downloads
-------------	----------------	-------------	-----------



Features

- › Safety hinge with integrated safety function
- › Operating point can be readjusted
- › Ideal use with hinged doors
- › Suitable for profile mounting
- › Connection via plug connector M12

The safety hinges ESH are safety devices for monitoring movable safety guards, such as doors or covers on machinery or systems.
On the safety hinges ESH-ARO... the operating point can be adjusted as often as necessary.

Important:

During mounting the axes of the hinges used must be exactly aligned.

Switching element

20 Snap-action switching contact 2NC↻

Approvals



Mechanical values and environment

Housing material	Die-cast zinc, nickel-plated
Weight	
Net	0,8 kg
Ambient temperature	-25 ... 70 °C
Degree of protection	IP67
Mechanical life	1 x 10 ⁶
Max. load as per mechanical life test according to EN 1935	Grade 12 ^[1]
Contact material	Silver
Switching principle	Snap-action switching contact
Installation position	Any
Number of door position positively driven contacts	2
Actuation frequency	
operating cycles	max.1200 1/h
Operating point	4° from fixing point
Positively driven	Approx. 10° from fixing point
Pivoting angle	-10 ... 180 °

Electrical connection ratings

Rated thermal current I _{th}	3 A
Utilization category according to EN 60947-5-1	
AC-15	1.5A 30V
DC-13	2.0A 24V
Short circuit protection according to IEC 60269-1	2A gG
Rated insulation voltage U _i	60 V
Rated impulse withstand voltage U _{imp}	2,5 kV
Switching current	
at 24V	min.1 mA
Degree of contamination (external, according to EN 60947-1)	
Industry	3

[1] 100kg door weight

Dimension drawing

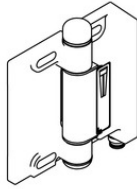
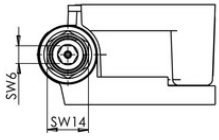
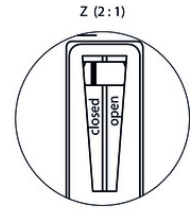
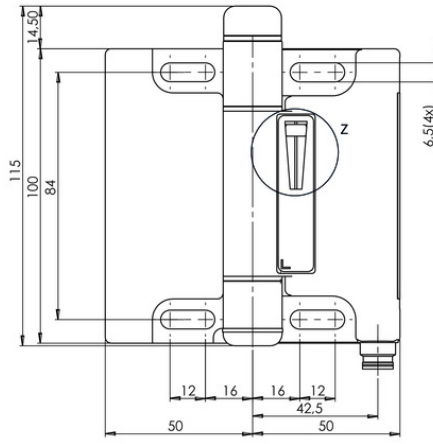
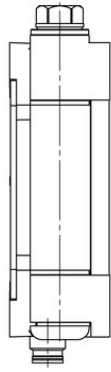
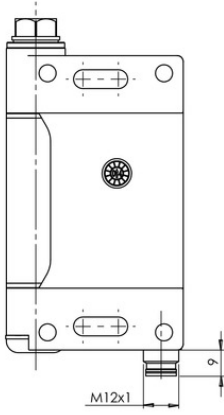
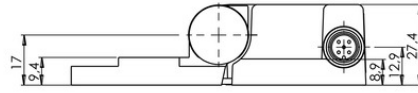
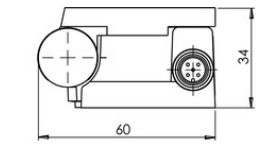

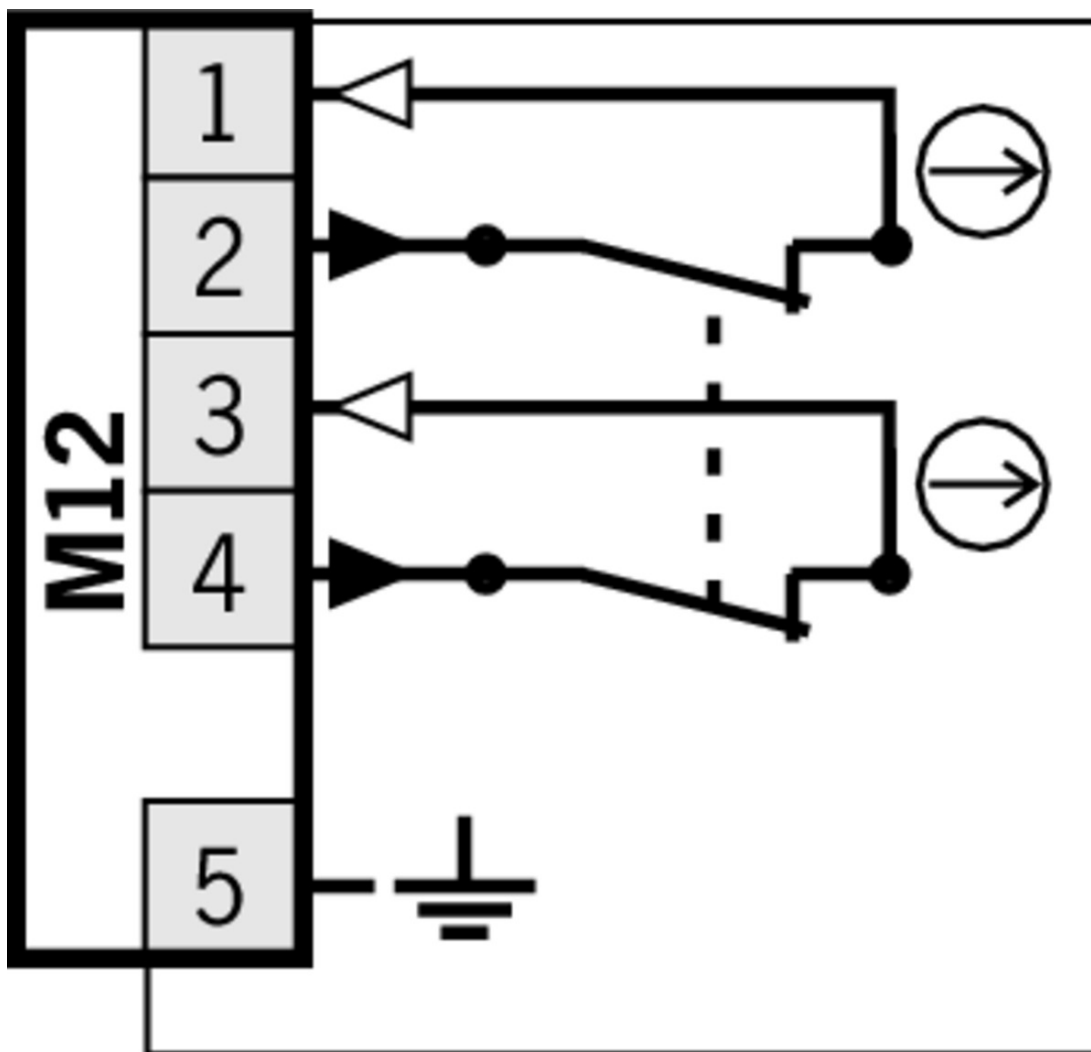

Function expansion

- ✓ ESH matching hinge (without safety function)



096007 ESH-PRO

Connection material

- ✓ Connection cable with straight plug connector M12, 5-pin, 5m



073461 C-M12F05-05X050PU05,0-GA-073461

✓ Features

- › M12 female plug, 4-pin + PE
- › Straight plug connector
- › PUR cable
- › Halogen-free
- › Cable length 5 m
- › With flying lead

› Cores color-coded

☑ Connection cable with angled plug connector M12, 5-pin, 5m



073462 C-M12F05-05X050PU05,0-GA-073462

☑ Features

- › M12 female plug, 4-pin + PE
- › Angled plug connector
- › PUR cable
- › Halogen-free
- › Cable length 5 m
- › With flying lead
- › Cores color-coded













Instructions

☑ Betriebsanleitung Schaltscharnier ESH wiedereinstellbar

	Doc. no.	Version	Language	Download
Betriebsanleitung Schaltscharnier ESH wiedereinstellbar	109804	04-03/16	 	 1.8 MB
Manual de instrucciones Bisagra ESH reajustable				
Mode d'emploi Charnière ESH réglable				
Istruzioni di impiego Finecorsa a cerniera ESH reimpostabile				
Operating Instructions Safety Hinge ESH Readjustable				

Catalogs

☑ Sicherheitsschalter mit Metallgehäuse Safety Switches with Metal Housing Bezpečnostní spínače s kovovým pouzdem Interrupteurs de sécurité avec boîtier métallique 金属壳体 的安全开关 Interruptores de seguridad con carcasa metálica

	Doc. no.	Version	Language	Download
Sicherheitsschalter mit Metallgehäuse	100319	11-03/18		 7.9 MB
Interrupteurs de sécurité avec boîtier métallique	100676	11-03/18		 7.9 MB
Interruptores de seguridad con carcasa metálica	104856	11-03/18		 14.0 MB
Safety Switches with Metal Housing	100369	11-03/18		 7.9 MB
Bezpečnostní spínače s kovovým pouzdem	121650	11-03/18		 7.9 MB
金属壳体 的安全开关	102453	11-03/18		 8.2 MB

Declaration of conformity

☑ EU-Konformitätserklärung

Doc. no.	Version	Language	Download
----------	---------	----------	----------

EU-Konformitätserklärung
Declaración UE de conformidad
Déclaration UE de conformité
Dichiarazione di conformità
EU declaration of conformity

2097676 08-04/17



 0.2 MB