

ITEM 089725 GP1-528A-M

Description	Technical data	Accessories	Downloads
-------------	----------------	-------------	-----------



Features

- › Cable entry M20 x 1.5

Approach direction

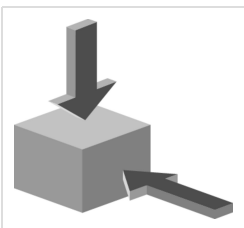

› Figure

Horizontal and vertical
Can be adjusted in 90° steps

Switching element

528 Slow-action switching contact 1 NC \ominus + 1 NO

Approvals



Mechanical values and environment

Housing material	Reinforced thermoplastic
Weight	
Net	0,5 kg
Ambient temperature	-20 ... 80 °C
Degree of protection	IP67
Mechanical life	2×10^6
Contact material	Silver alloy, gold flashed
Switching principle	Slow-action switching contact
Installation position	Any
Number of door position positively driven contacts	1
Number of door position NO contacts	1
Connection	
	3 x M20 x 1.5
Approach speed	
max.	20 m/min
Actuation frequency	6700 1/h
Retention force	2 N
Extraction force	20 N
Actuating force	10 N
Insertion depth	
Horizontal	28 mm
Vertical	29,5 mm

Electrical connection ratings

Rated thermal current I_{th}	4 A
Utilization category according to EN 60947-5-1	
AC-15	4A 230V
DC-13	4A 24V
Short circuit protection according to IEC 60269-1	
(Fuse)	4A gG
Rated insulation voltage U_i	250 V
Rated impulse withstand voltage U_{imp}	2,5 kV
Switching voltage	
Min. at 10mA	12 V

Switching current	Min. at 24V	1 mA
Connection cross-section		0,34 ... 1,5 mm ²

Reliability values acc. to EN ISO 13849-1

		Monitoring of the safety guard position
B10 _D		3 x 10 ⁶

in combination with Actuator BETAETIGER-P-GT

Mechanical values and environment

Overtravel	Horizontal	2 mm
	Vertical	1,5 mm

in combination with Actuator BETAETIGER-P-GNT

Mechanical values and environment

Overtravel	Horizontal	7 mm
	Vertical	7 mm

Dimension drawing

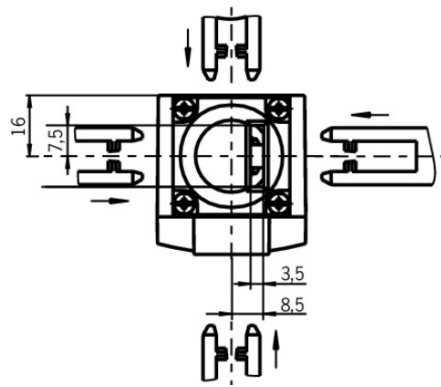
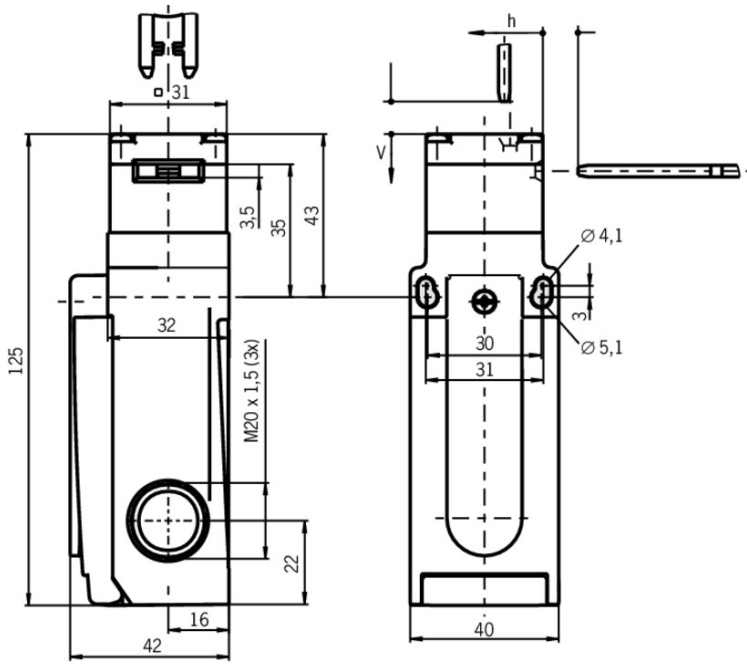

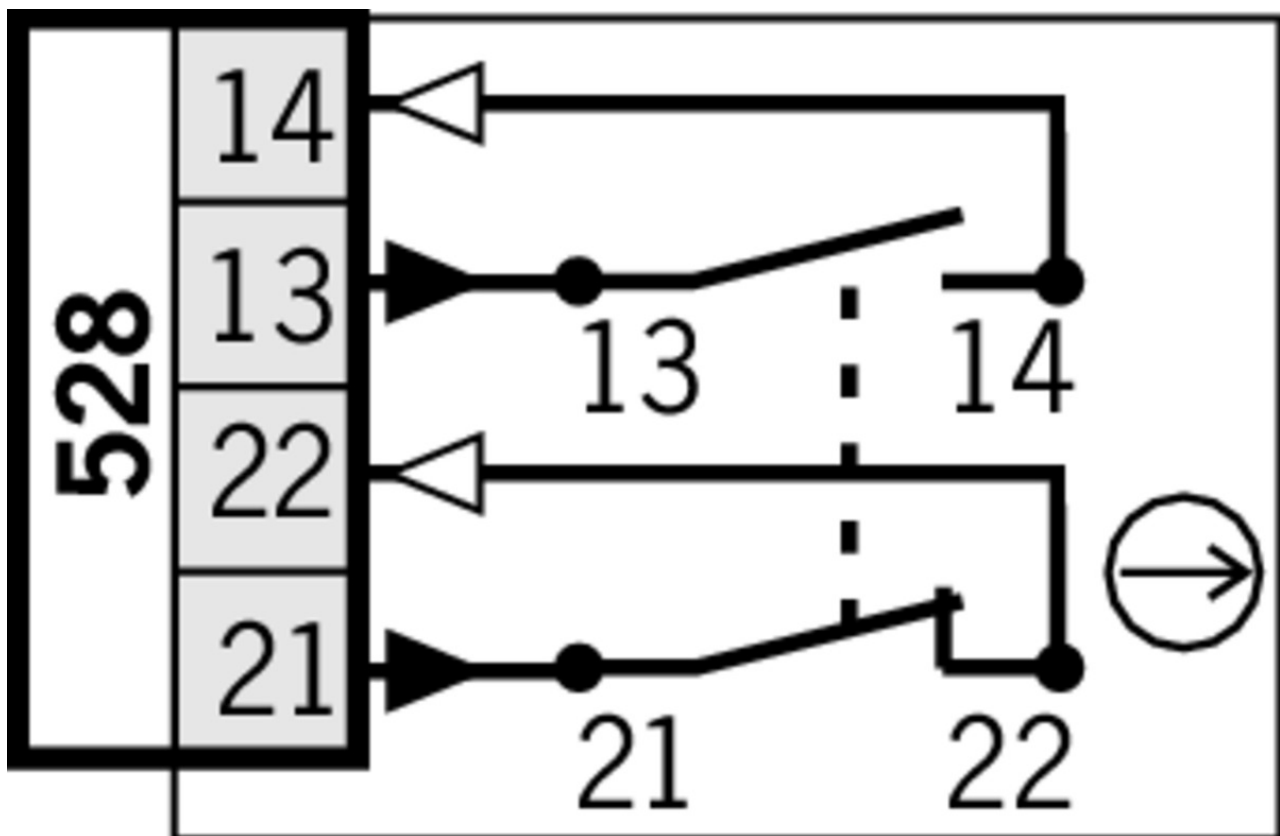

Function expansion

✓ Built-in LED



087423 EINBAULEUCHTE LED M20X1,5



095510 EINBAULEUCHTE LED-F M20X1,5

✓ Insertion funnel for safety switches NP../GP/TP../A



086237 EINFUEHRTRICHTER-P

✓ Lockout bar NP/GP/TP



096105 SPERREINSATZ TP

✓ Features

- › Prevents unintentional closing of the door
- › Can be secured with padlocks

✓ Latch spring for increased retention force

076501 RASTFEDER NP/TP

Connection material

- ✓ Cable glands M20x1.5



086233 EKPM20/06 086233

Bolt

- ✓ Bolt 1 NP/TP for safety switches NP, GP and TP



073536 RIEGEL 1 NP/TP 1X RASTUNG ZU

- ✓ Features
 - › Steel bolt
 - › For doors hinged on the left or right
 - › Can be locked in open position with padlocks
 - › Actuator included
 - › Detent mechanism closed position
-

- ✓ Bolt 0 NP/TP for safety switches NP, GP and TP



073535 RIEGEL 0 NP/TP OHNE RASTUNG

- ✓ Features
 - › Steel bolt
 - › For doors hinged on the left or right
 - › Can be locked in open position with padlocks
 - › Actuator included
-

- ✓ Bolt TP/GP... for safety switches GP and TP



084430 RIEGEL TP-A

- ✓ Features
 - › Steel bolt
 - › For doors hinged on the right
 - › Can be locked in open position with padlocks
 - › Actuator included
-



084432 RIEGEL TP-C

- ✓ Features
 - › Steel bolt
 - › For doors hinged on the left
 - › Can be locked in open position with padlocks
 - › Actuator included
-

- ✓ Bolt BTC-T/GP... without escape release for safety switches GP and TP

106301 BTC-T/GP-S-TH-00-X



- ✓ Features
 - › Aluminum bolt
 - › For doors hinged on the left or right
 - › Can be locked in open position with padlocks
 - › Actuator included
-

- ✓ Bolt BTC-T/GP... with escape release for safety switches GP and TP



- 106302** BTC-T/GP-S-TH-01-F
 - ✓ Features
 - › Aluminum bolt
 - › For doors hinged on the left or right
 - › Lever for escape release from the danger area
 - › Pushbutton in open position
 - › Can be locked in open position with padlocks
 - › Actuator included
-

- ✓ Bolt TP-GFK-F with escape release for safety switches TP and GP



- 097602** RIEGEL TP-GFK-F
 - ✓ Features
 - › Fiber glass reinforced plastic bolt
 - › For doors hinged on the left or right
 - › Lever for escape release from the danger area
 - › Detent knob in open position
 - › Can be locked in open position with padlocks
 - › Actuator included
-

- ✓ Bolt TP-GFK for safety switches TP and GP



- 096616** RIEGEL TP-GFK
 - ✓ Features
 - › Fiber glass reinforced plastic bolt
 - › For doors hinged on the left or right
 - › Can be locked in open position with padlocks
 - › Actuator included
-

- ✓ Bolt TP/GP... with escape release for safety switches GP and TP



- 086186** RIEGEL TP-AF
 - ✓ Features
 - › Steel bolt
 - › Lever for escape release from the danger area
 - › For doors hinged on the right
 - › Detent knob in open position
 - › Can be locked in open position with padlocks
 - › Actuator included
-



- 086188** RIEGEL TP-CF
 - ✓ Features
 - › Steel bolt
 - › Lever for escape release from the danger area

- › For doors hinged on the left
 - › Detent knob in open position
 - › Can be locked in open position with padlocks
 - › Actuator included
-

Actuator

- ▼ Bent actuator for safety switches NP/GP/TP, increased overtravel



074571 BETAETIGER-P-WN

▼ Features

- › Actuators made of stainless steel
 - › Two stainless safety screws per actuator
-



074577 BETAETIGER-P-WNT

▼ Features

- › Actuators made of stainless steel
 - › Two stainless safety screws per actuator
 - › Actuators with rubber bushings
-

- ▼ Actuators for safety switches NP/GP/TP



070046 BETAETIGER-P-GT

▼ Features

- › Actuators made of stainless steel
 - › Two stainless safety screws per actuator
 - › Actuators with rubber bushings
-



059226 BETAETIGER-P-G

▼ Features

- › Actuators made of stainless steel
 - › Two stainless safety screws per actuator
-

- ▼ Bent actuator for safety switches NP/GP/TP



070038 BETAETIGER-P-WT

▼ Features

- › Actuators made of stainless steel
 - › Two stainless safety screws per actuator
 - › Actuators with rubber bushings
-



059227 BETAETIGER-P-W

▼ Features

- › Actuators made of stainless steel
 - › Two stainless safety screws per actuator
-

- ▼ Actuators for safety switches NP/GP/TP, increased overtravel

074570 BETAETIGER-P-GN



- ✓ Features
 - › Actuators made of stainless steel
 - › Two stainless safety screws per actuator
-



074576 BETAETIGER-P-GNT

- ✓ Features
 - › Actuators made of stainless steel
 - › Two stainless safety screws per actuator
 - › Actuators with rubber bushings
-

- ✓ Hinged actuator top/bottom for safety switches NP/GP/TP



070050 RADIUSBETAETIGER-P-OU

- ✓ Features
 - › Actuators made of stainless steel
 - › Two stainless safety screws per actuator
 - › For doors hinged at top and bottom
-

- ✓ Hinged actuator left/right for safety switches NP/GP/TP



059440 RADIUSBETAETIGER-P-LR

- ✓ Features
 - › Actuators made of stainless steel
 - › Two stainless safety screws per actuator
 - › For doors hinged on right and left
-

- ✓ Hinged actuator top/bottom for safety switches NP/GP/TP, increased overtravel



074572 RADIUSBETAETIGER-P-OUN

- ✓ Features
 - › Actuators made of stainless steel
 - › Two stainless safety screws per actuator
 - › For doors hinged at top and bottom
-

- ✓ Hinged actuator left/right for safety switches NP/GP/TP, increased overtravel



074573 RADIUSBETAETIGER-P-LRN

- ✓ Features
 - › Actuators made of stainless steel
 - › Two stainless safety screws per actuator
 - › For doors hinged on right and left
-

Mounting accessories

- ✓ Safety screws M5 x 25

073457 M5X25/V100

- ✓ Features
 - › Safety screws M5 x 25

› Packaging unit 100 pieces

▼ Switch bracket for bolt NP/TP



073539 SCHALTERAUFNAHME TP

▼ Features

- › Switch bracket made of steel
- › For doors hinged on the left or right

▼ Switch bracket TP/STP GFK



096613 SCHALTERAUFNAHME TP/STP GFK

▼ Features

- › Switch bracket made of fiber glass reinforced plastic
- › For left or right hinged doors

Instructions

▼ Betriebsanleitung Sicherheitsschalter GP...

	Doc. no.	Version	Language	Download
Betriebsanleitung Sicherheitsschalter GP...	090205	07-10/15		2.5 MB
Manual de instrucciones Interruptores de seguridad GP...				
Mode d'emploi Interrupteur de sécurité GP...				
Istruzioni di impiego Finecorsa di sicurezza GP...				
Operating Instructions Safety Switch GP...				

Catalogs















▼ Bezpečnostní spínače s plastovým pouzdrém Sicherheitsschalter mit Kunststoffgehäuse Safety Switches with Plastic Housing Interruptores de seguridad con carcasa plástica Interrupteurs de sécurité avec boîtier plastique 塑料壳体 的安全开关

	Doc. no.	Version	Language	Download
Sicherheitsschalter mit Kunststoffgehäuse	096955	11-03/18		6.6 MB
Interrupteurs de sécurité avec boîtier plastique	100677	11-03/18		6.6 MB
Interruptores de seguridad con carcasa plástica	104855	11-03/18		6.6 MB
Bezpečnostní spínače s plastovým pouzdrém	121649	11-03/18		6.6 MB
Safety Switches with Plastic Housing	096956	11-03/18		6.6 MB
塑料壳体 的安全开关	116243	11-03/18		6.2 MB

Declaration of conformity

▼ EU prohlášení o shodě

Doc. no.	Version	Language	Download
----------	---------	----------	----------

EU-Konformitätserklärung	2077153	25-02/17		 0.3 MB
Declaración UE de conformidad				
Déclaration UE de conformité				
Dichiarazione di conformità				
EU declaration of conformity				
EU prohlášení o shodě	2077153	25-02/17		 0.5 MB
EU-overensstemmelseserklæring				
Δήλωση συμμόρφωσης της ΕΕ				
EU-vaatimustenmukaisuusvakuutus				
EU-típusbizonyítvány				
EU-conformiteitsverklaring				
Deklaracja zgodności UE				
Declaração de Conformidade UE				
Declarația de conformitate UE				
EÚ vyhlásenie o zhode				

CAD data

CAD data for this item on TraceParts