

ITEM 085626 NM11VZA-SM4

Description	Technical data	Accessories	Downloads
-------------	----------------	-------------	-----------



Features

- › Plug connector M12

Approach direction

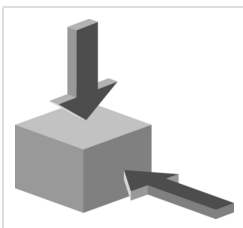

- › Figure
Horizontal and vertical
Can be adjusted in 90° steps

Switching element

ES11 Slow-action switching contact 1 NC \ominus + 1 NO

Approvals



Mechanical values and environment

Ambient temperature	-20 ... 80 °C
Mechanical life	1×10^6
Number of door position positively driven contacts	1
Number of door position NO contacts	1
Actuation frequency	7000 1/h
Retention force	2 N
Extraction force	10 N
Actuating force	10 N
Insertion depth	20 mm

Electrical connection ratings

Rated thermal current I_{th}	4 A
Utilization category according to EN 60947-5-1	AC-15 DC-13
Rated insulation voltage U_i	250 V
Rated impulse withstand voltage U_{imp}	2,5 kV
Connection cross-section	0,34 ... 1,5 mm ²

in combination with Actuator BETAETIGER-M-G

Mechanical values and environment

Overtravel	4 mm
------------	------

Dimension drawing

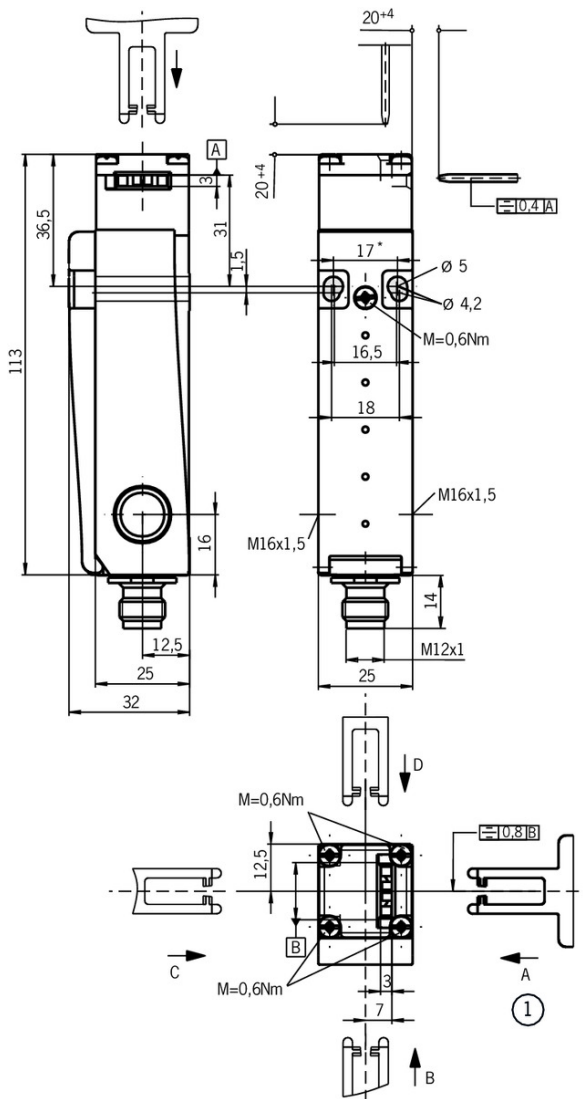

Legende

1 Standard

* fixed positioning for safety-related applications (M5)

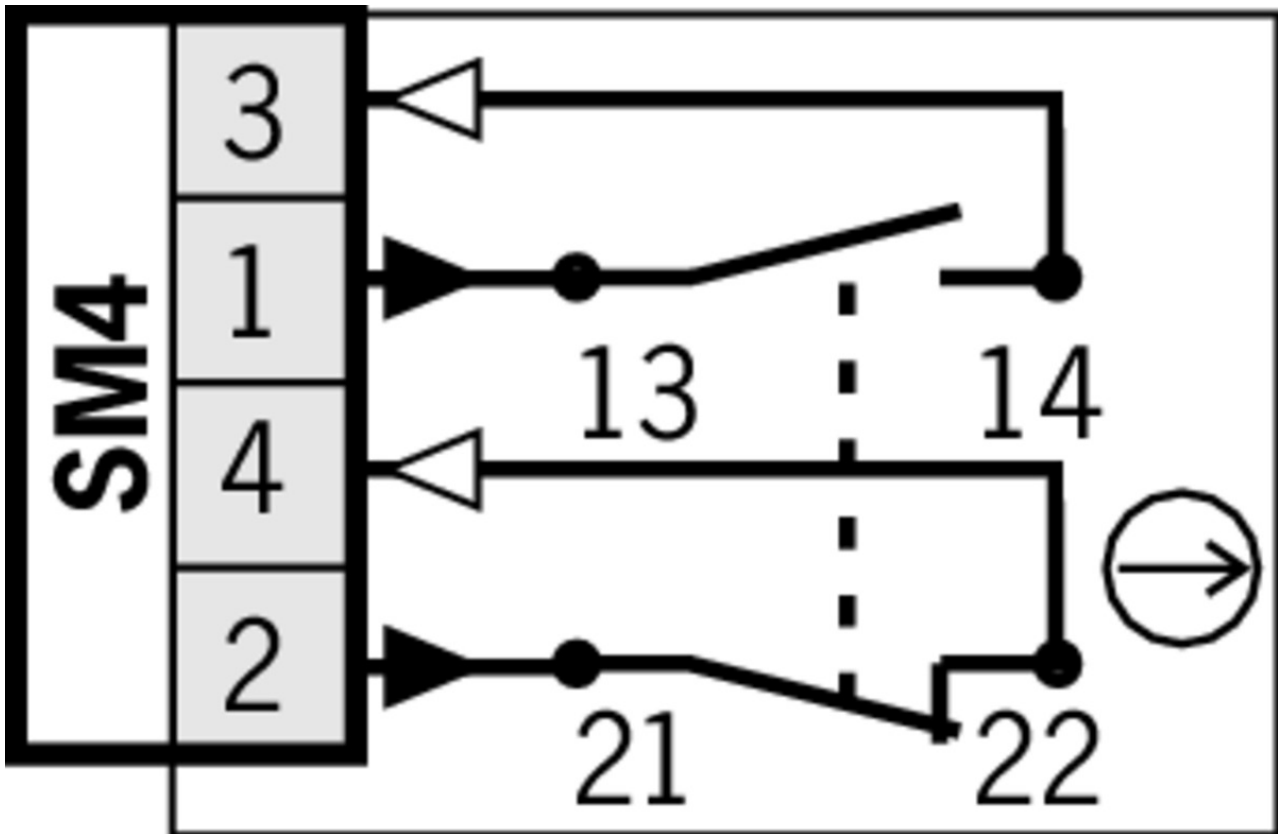

Actuator

Actuators for safety switches NM.VZ



074077 BETAETIGER-M-W

Features

- › Actuators made of stainless steel
- › Two stainless safety screws per actuator



074076 BETAETIGER-M-G

Features

- › Actuators made of stainless steel
- › Two stainless safety screws per actuator



074130 BETAETIGER-M-GTS

Features

- › Actuators made of stainless steel
- › Two stainless safety screws per actuator
- › Actuators with rubber bushings
- › Compact design



074128 BETAETIGER-M-GS

Features

- › Actuators made of stainless steel
- › Two stainless safety screws per actuator

- › Compact design



074129 BETAETIGER-M-WS

✓ Features

- › Actuators made of stainless steel
- › Two stainless safety screws per actuator
- › Compact design



074078 BETAETIGER-M-GT

✓ Features

- › Actuators made of stainless steel
- › Two stainless safety screws per actuator
- › Actuators with rubber bushings



074079 BETAETIGER-M-GQ

✓ Features

- › Actuators made of stainless steel
- › Two stainless safety screws per actuator
- › Actuators with rubber bushings



074080 BETAETIGER-M-WT

✓ Features

- › Actuators made of stainless steel
- › Two stainless safety screws per actuator
- › Actuators with rubber bushings

Mounting accessories

- ✓ Mounting plates EMP-SC for safety switches NM, NP...AS and NZ



085753 EMP-SC

✓ Features

- › For vertical and horizontal mounting of safety switches NM, NP...AS and NZ

- ✓ Safety screws M5 x 25

073457 M5X25/V100

✓ Features

- › Safety screws M5 x 25
- › Packaging unit 100 pieces

- ✓ Safety screws for actuators, M5 x 10

073455 M5X10-NIRO/V100 NZ/TZ

✓ Features

- › Safety screws M5 x 10
- › Packaging unit 100 pieces

▼ Safety screws M4 x 14

074063 M4X14/V100

▼ Features

- › Safety screws M4 x 14
 - › Packaging unit 100 pieces
-

▼ Switch bracket for bolt NM



077245 SCHALTERAUFNAHME NM

▼ Features

- › Switch bracket made of steel
 - › For doors hinged on the left or right
-

Function expansion

▼ Insertion funnel for safety switches NM..VZ

083565 EINFUEHRTRICHTER-M

Connection material

▼ Plug connector M12



035613 C-M12F04-04X034PU05,0-GA-035613

▼ Features

- › M12 female plug, 4-pin
 - › Straight plug connector
 - › PUR cable
 - › Halogen-free
 - › Cable length 5 m
 - › With flying lead
 - › Cores color-coded
-



035618 C-M12F04-04X034PU05,0-GA-035618

▼ Features

- › M12 female plug, 4-pin
 - › Angled plug connector
 - › PUR cable
 - › Halogen-free
 - › Cable length 5 m
 - › With flying lead
 - › Cores color-coded
-













Instructions

Manual de instrucciones Interruptores de seguridad NM..VZ

	Doc. no.	Version	Language	Download
Betriebsanleitung Sicherheitsschalter NM..VZ Operating Instructions Safety Switch NM..VZ	2084458	08-02/18		 1.0 MB
Mode d'emploi Interrupteur de sécurité NM..VZ	2084458	08-02/18		 0.5 MB
Manual de instrucciones Interruptores de seguridad NM..VZ	2084458	08-02/18		 0.5 MB
Istruzioni di impiego Finecorsa di sicurezza NM..VZ	2084458	08-02/18		 0.5 MB
Návod na prevádzku Bezpečnostný spínač NM..VZ	2084458	08-02/18		 0.9 MB

Catalogs

Bezpečnostní spínače s plastovým pouzdem Sicherheitsschalter mit Kunststoffgehäuse Safety Switches with Plastic Housing Interruptores de seguridad con carcasa plástica Interrupteurs de sécurité avec boîtier plastique 塑料壳体 的安全开关

	Doc. no.	Version	Language	Download
Sicherheitsschalter mit Kunststoffgehäuse	096955	11-03/18		 6.6 MB
Interrupteurs de sécurité avec boîtier plastique	100677	11-03/18		 6.6 MB
Interruptores de seguridad con carcasa plástica	104855	11-03/18		 6.6 MB
Bezpečnostní spínače s plastovým pouzdem	121649	11-03/18		 6.6 MB
Safety Switches with Plastic Housing	096956	11-03/18		 6.6 MB
塑料壳体 的安全开关	116243	11-03/18		 6.2 MB

Declaration of conformity

EU prohlášení o shodě

	Doc. no.	Version	Language	Download
EU-Konformitätserklärung Declaración UE de conformidad Déclaration UE de conformité Dichiarazione di conformità EU declaration of conformity	2077153	25-02/17	    	 0.3 MB
EU prohlášení o shodě EU-overensstemmelseserklæring Δήλωση συμμόρφωσης της ΕΕ EU-vaatimustenmukaisuusvakuutus EU-típusbizonyítvány EU-conformiteitsverklaring Deklaracja zgodności UE Declaração de Conformidade UE Declarația de conformitate UE EÚ vyhlásenie o zhode	2077153	25-02/17	         	 0.5 MB

CAD data

CAD data for this item on TraceParts