

ITEM 084545 NM01AV-M

Description	Technical data	Accessories	Downloads
-------------	----------------	-------------	-----------

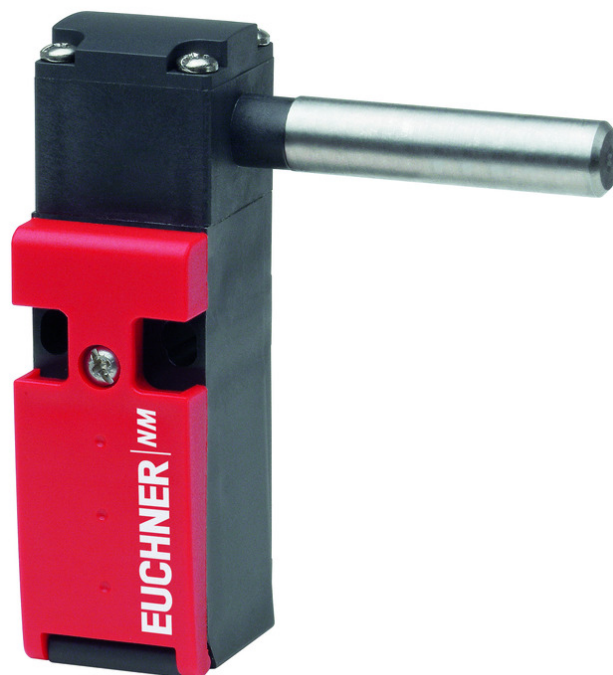

Features

- › Hinged actuator as solid shaft
- › Shaft length 75 mm
- › Cable entry M16 x 1.5

Switching element

ES01 Slow-action switching contact 1 NC↻

Approvals



Mechanical values and environment

Ambient temperature	-20 ... 80 °C
Mechanical life	4 x 10 ⁶

Number of door position positively driven contacts	1
Actuation frequency	5000 1/h
Actuating torque	0,1 Nm

Electrical connection ratings

Rated thermal current I_{th}	4 A
Utilization category according to EN 60947-5-1	AC-15 DC-13
Rated insulation voltage U_i	250 V
Rated impulse withstand voltage U_{imp}	2,5 kV
Connection cross-section	0,34 ... 1,5 mm ²

Dimension drawing

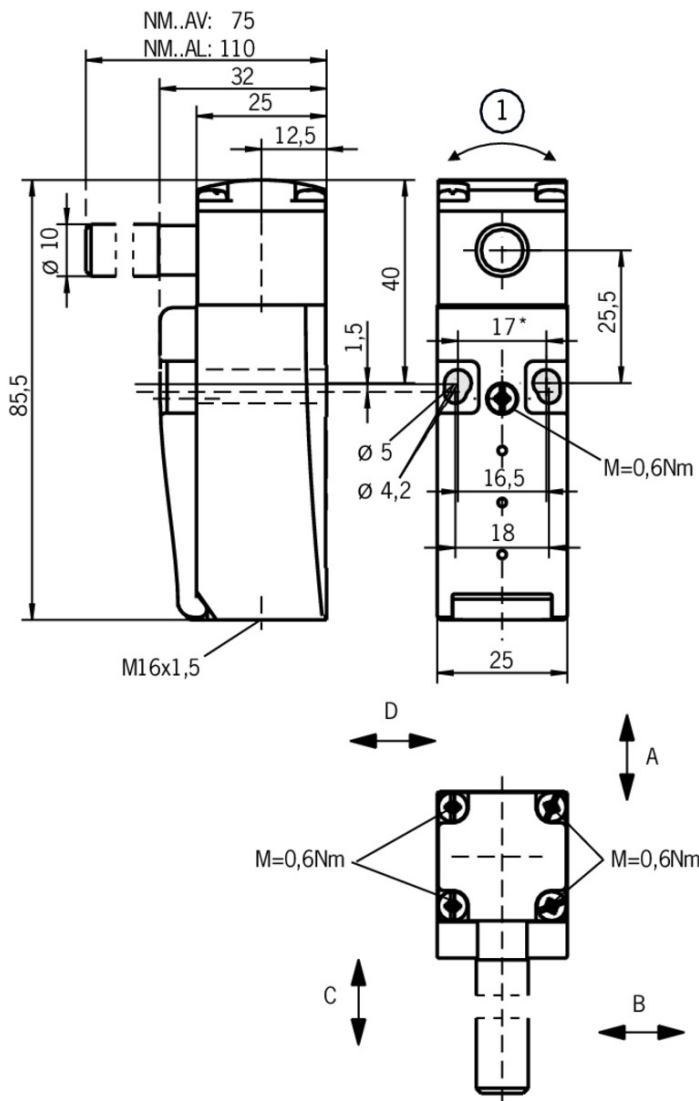

Legende

1 Actuating direction

* fixed positioning for safety-related applications (M5)

ES01

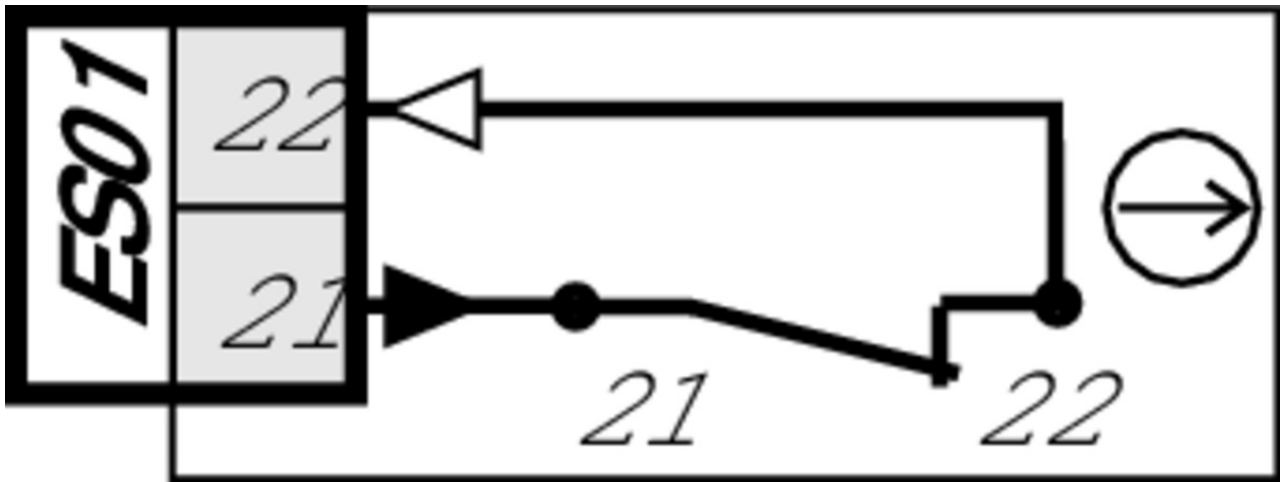

Travel diagram

NM...AV
NM..AL
NM..AG
NM..AK



ES01

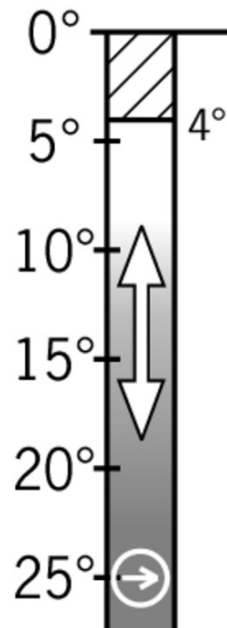
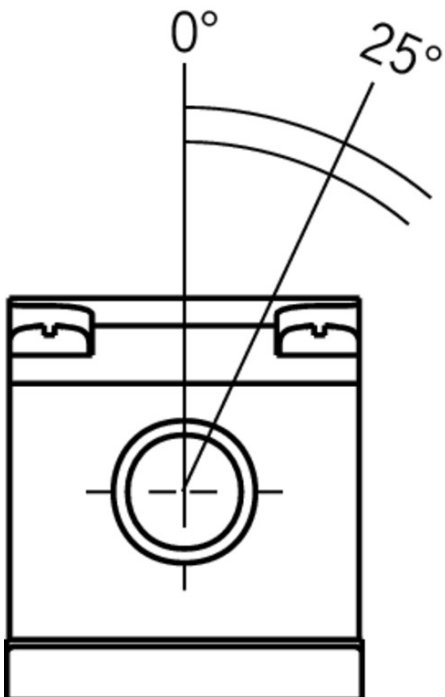

21-22



Legende

-  Contacts closed
-  Contacts open
-  Contacts positively driven

Mounting accessories

-  Mounting plates EMP-SC for safety switches NM, NP...AS and NZ



085753 EMP-SC

-  Features

-  For vertical and horizontal mounting of safety switches NM, NP...AS and NZ

Connection material

▼ Cable glands M16x1.5



084572 EKPM16/05

Instructions

▼ Manual de instrucciones Interruptores de seguridad NM..AV/AL

	Doc. no.	Version	Language	Download
Betriebsanleitung Sicherheitsschalter NM..AV/AL Operating Instructions Safety Switch NM..AV/AL	2084463	07-02/18		0.9 MB
Mode d'emploi Interrupteur de sécurité NM..AV/AL	2084463	07-02/18		0.5 MB
Manual de instrucciones Interruptores de seguridad NM..AV/AL	2084463	07-02/18		0.5 MB
Istruzioni di impiego Finecorsa di sicurezza NM..AV/AL	2084463	07-02/18		0.5 MB

Catalogs









▼ Bezpečnostní spínače s plastovým pouzdrém Sicherheitsschalter mit Kunststoffgehäuse Safety Switches with Plastic Housing Interruptores de seguridad con carcasa plástica Interrupteurs de sécurité avec boîtier plastique 塑料壳体 的安全开关

	Doc. no.	Version	Language	Download
Sicherheitsschalter mit Kunststoffgehäuse	096955	11-03/18		6.6 MB
Interrupteurs de sécurité avec boîtier plastique	100677	11-03/18		6.6 MB
Interruptores de seguridad con carcasa plástica	104855	11-03/18		6.6 MB
Bezpečnostní spínače s plastovým pouzdrém	121649	11-03/18		6.6 MB
Safety Switches with Plastic Housing	096956	11-03/18		6.6 MB
塑料壳体 的安全开关	116243	11-03/18		6.2 MB

Declaration of conformity

▼ EU prohlášení o shodě

	Doc. no.	Version	Language	Download
EU-Konformitätserklärung Declaración UE de conformidad Déclaration UE de conformité Dichiarazione di conformità EU declaration of conformity	2077153	25-02/17		0.3 MB

EU prohlášení o shodě	2077153	25-02/17		 0.5 MB
EU-overensstemmelseserklæring				
Δήλωση συμμόρφωσης της ΕΕ				
EU-vaatimustenmukaisuusvakuutus				
EU-típusbizonyítvány				
EU-conformiteitsverklaring				
Deklaracja zgodności UE				
Declaração de Conformidade UE				
Declarația de conformitate UE				
EÚ vyhlásenie o zhode				

CAD data

CAD data for this item on TraceParts