

ITEM 059446 NP2-618AB

Description	Technical data	Accessories	Downloads
-------------	----------------	-------------	-----------



Features

- › Mounting with 40 mm spacing
- › Plug connector SR6

Approach direction

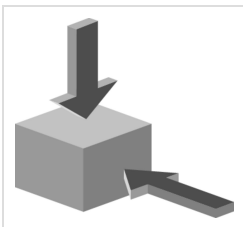

- › Figure
Horizontal and vertical
Can be adjusted in 90° steps

Switching element

618 Slow-action switching contact 1 NC ⊕

Approvals



Mechanical values and environment

Housing material	Reinforced thermoplastic
Weight	
	Net 0,5 kg
Ambient temperature	-20 ... 80 °C
Degree of protection	IP65
Mechanical life	1 x 10 ⁶
Contact material	Silver alloy, gold flashed
Switching principle	Slow-action switching contact
Mounting method	Installation with 40mm hole spacing
Installation position	Any
Number of door position positively driven contacts	1
Connection	
	1 x Plug connector SR6 [1]
Approach speed	
	max. 20 m/min
Actuation frequency	7000 1/h
Retention force	2 N
Extraction force	15 N
Actuating force	5 N
Insertion depth	
	Horizontal 28 mm
	Vertical 29,5 mm

Electrical connection ratings

Rated thermal current I _{th}	4 A [2]
Utilization category according to EN 60947-5-1	
	AC-15 4A 230V [3]
	DC-13 4A 24V [4]
Short circuit protection according to IEC 60269-1	
	(Fuse) 4A gG [5]
Rated insulation voltage U _i	250 V
Rated impulse withstand voltage U _{imp}	2,5 kV
Switching voltage	
	Min. at 10mA 24 V
Switching current	
	Min. at 24V 30 mA

Reliability values acc. to EN ISO 13849-1

	Monitoring of the safety guard position
B10 _D	3×10^6

in combination with Actuator BETAETIGER-P-GT

Mechanical values and environment

Overtravel A B C D E	Horizontal	2 mm
Overtravel K L M N	Vertical	1,5 mm

in combination with Actuator BETAETIGER-P-GNT

Mechanical values and environment

Overtravel A B C D E	Horizontal	7 mm
----------------------	------------	------

[1] 6-pin + PE

[2, 3, 4] >70°C => 2A

[5] >70°C => 2AgG

Dimension drawing

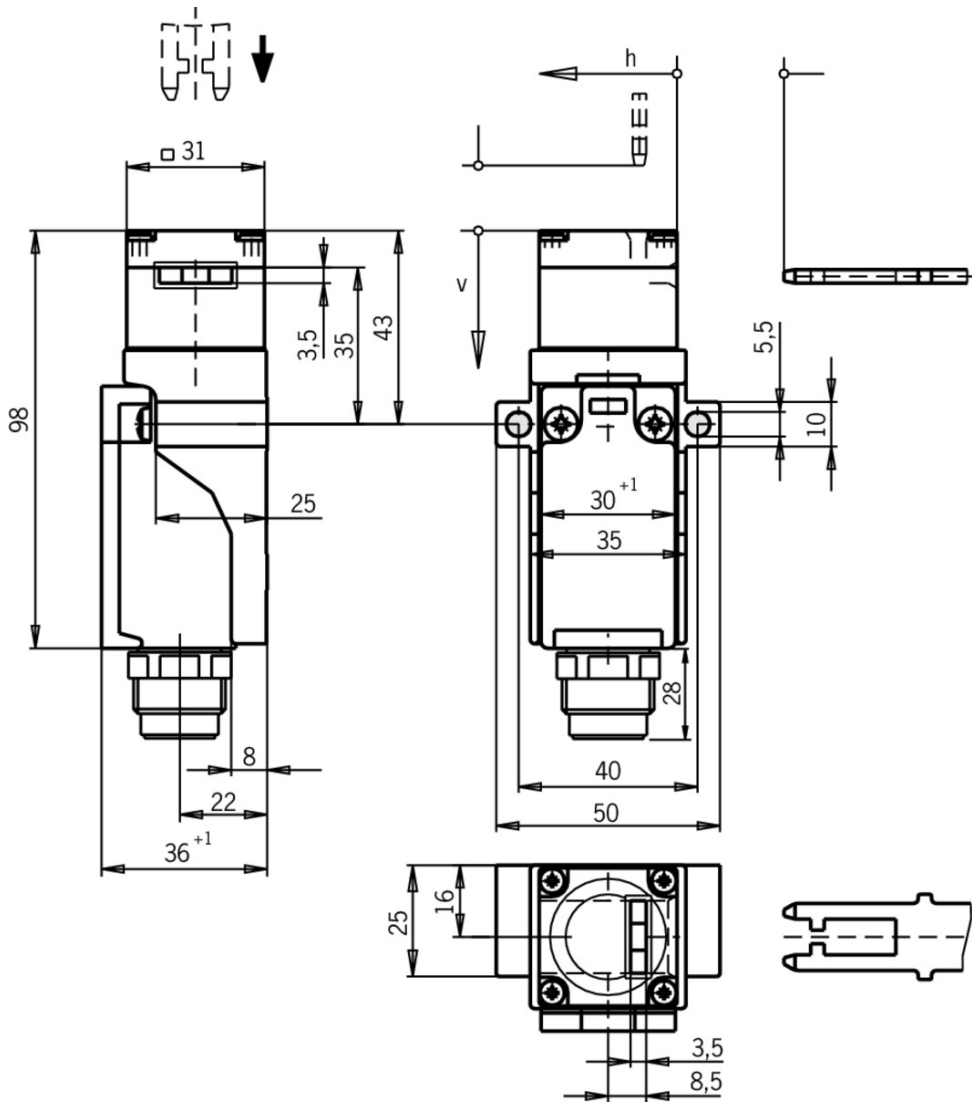

618

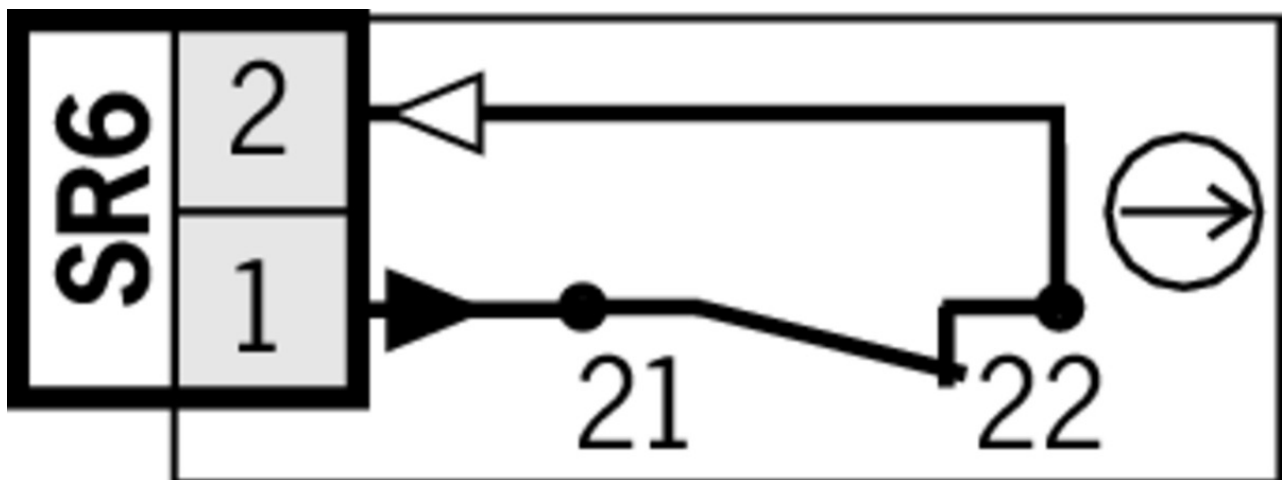

Function expansion

✓ Insertion funnel for safety switches NP..A/GP/TP..A



086237 EINFUEHRTRICHTER-P

▼ Lockout bar NP/GP/TP



096105 SPERREINSATZ TP

▼ Features

- › Prevents unintentional closing of the door
 - › Can be secured with padlocks
-

▼ Latch spring for increased retention force

076501 RASTFEDER NP/TP

▼ Adapter NP-K



074578 ADAPTER NP-K

Actuator

▼ Hinged actuator top/bottom for safety switches NP/GP/TP, increased overtravel



074572 RADIUSBETAETIGER-P-OUN

▼ Features

- › Actuators made of stainless steel
 - › Two stainless safety screws per actuator
 - › For doors hinged at top and bottom
-

▼ Hinged actuator left/right for safety switches NP/GP/TP, increased overtravel



074573 RADIUSBETAETIGER-P-LRN

▼ Features

- › Actuators made of stainless steel
 - › Two stainless safety screws per actuator
 - › For doors hinged on right and left
-

▼ Actuators for safety switches NP/GP/TP



059226 BETAETIGER-P-G

▼ Features

- › Actuators made of stainless steel
 - › Two stainless safety screws per actuator
-



070046 BETAETIGER-P-GT

▼ Features

- › Actuators made of stainless steel
- › Two stainless safety screws per actuator

- › Actuators with rubber bushings
-

▼ Bent actuator for safety switches NP/GP/TP



059227 BETAETIGER-P-W

▼ Features

- › Actuators made of stainless steel
 - › Two stainless safety screws per actuator
-



070038 BETAETIGER-P-WT

▼ Features

- › Actuators made of stainless steel
 - › Two stainless safety screws per actuator
 - › Actuators with rubber bushings
-

▼ Actuators for safety switches NP/GP/TP, increased overtravel



074570 BETAETIGER-P-GN

▼ Features

- › Actuators made of stainless steel
 - › Two stainless safety screws per actuator
-



074576 BETAETIGER-P-GNT

▼ Features

- › Actuators made of stainless steel
 - › Two stainless safety screws per actuator
 - › Actuators with rubber bushings
-

▼ Bent actuator for safety switches NP/GP/TP, increased overtravel



074571 BETAETIGER-P-WN

▼ Features

- › Actuators made of stainless steel
 - › Two stainless safety screws per actuator
-



074577 BETAETIGER-P-WNT

▼ Features

- › Actuators made of stainless steel
 - › Two stainless safety screws per actuator
 - › Actuators with rubber bushings
-

▼ Hinged actuator top/bottom for safety switches NP/GP/TP



070050 RADIUSBETAETIGER-P-OU

▼ Features

- › Actuators made of stainless steel
 - › Two stainless safety screws per actuator
 - › For doors hinged at top and bottom
-

- ▼ Hinged actuator left/right for safety switches NP/GP/TP



059440 RADIUSBETAETIGER-P-LR

▼ Features

- › Actuators made of stainless steel
- › Two stainless safety screws per actuator
- › For doors hinged on right and left

Mounting accessories

- ▼ Mounting plates EMP-SC for safety switches NM, NP...AS and NZ



085753 EMP-SC

▼ Features

- › For vertical and horizontal mounting of safety switches NM, NP...AS and NZ

- ▼ Safety screws M5 x 25

073457 M5X25/V100

▼ Features

- › Safety screws M5 x 25
- › Packaging unit 100 pieces

- ▼ Safety screws for actuators, M5 x 10

073455 M5X10-NIRO/V100 NZ/TZ

▼ Features

- › Safety screws M5 x 10
- › Packaging unit 100 pieces

- ▼ Safety screws for safety switches M4 x 14, large head

086232 M4X14-NIRO/V100

▼ Features

- › Safety screws M4 x 14 (large head)
- › Packaging unit 100 pieces

- ▼ Switch bracket for bolt NP/TP



073538 SCHALTERAUFNAHME NP

▼ Features

- › Switch bracket made of steel
- › For doors hinged on the left or right

Connection material

- ▼ Plug connector SR6



013176 SR6EF

▼ Features

- › Crimp contacts
- › Coding shells



024999 SR6WFPG11R

▼ Features

- › Socket crimp contacts
- › 6-pin+PE
- › Contact carrier can be adjusted in 7 outlet directions

013178 SR6K

▼ Features

- › Coding for plug connector SR6
- › Coding shells

087180 SR6AM2-M20

▼ Features

- › Crimp contacts
- › Male socket

▼ Connection cable with plug connector SR6, 5m



077632 C-M26F07-07X1,0PU05,0-MA-077632

▼ Features

- › Female plug SR6, 6-pin + PE
- › Straight plug connector
- › PUR cable
- › Cable length 5 m
- › With flying lead

▼ Connection cable with plug connector SR6, 10m



077633 C-M26F07-07X1,0PU10,0-MA-077633

▼ Features

- › Female plug SR6, 6-pin + PE
- › Straight plug connector
- › PUR cable
- › Cable length 10 m
- › With flying lead

▼ Connection cable with plug connector SR6, 15m



077634 C-M26F07-07X1,0PU15,0-MA-077634

▼ Features

- › Female plug SR6, 6-pin + PE
- › Straight plug connector
- › PUR cable
- › Cable length 15 m
- › With flying lead

- ▼ Connection cable with plug connector SR6, 20m



098128 C-M26F07-07X1,0PU20,0-MA-098128

▼ Features

- › Female plug SR6, 6-pin + PE
 - › Straight plug connector
 - › PUR cable
 - › Cable length 20 m
 - › With flying lead
-

- ▼ Connection cable with plug connector SR6, 10m, angled



077639 C-R22F07-07X1,0PU10,0-MA-077639

▼ Features

- › Female plug SR6, 6-pin + PE
 - › Angled plug connector
 - › PUR cable
 - › Cable length 10 m
 - › With flying lead
-

- ▼ Connection cable with plug connector SR6, 15m, angled



077640 C-R22F07-07X1,0PU15,0-MA-077640

▼ Features

- › Female plug SR6, 6-pin + PE
 - › Angled plug connector
 - › PUR cable
 - › Cable length 15 m
 - › With flying lead
-

Bolt

- ▼ Bolt 0 NP/TP for safety switches NP, GP and TP



073535 RIEGEL 0 NP/TP OHNE RASTUNG

▼ Features

- › Steel bolt
 - › For doors hinged on the left or right
 - › Can be locked in open position with padlocks
 - › Actuator included
-

- ▼ Bolt 1 NP/TP for safety switches NP, GP and TP









073536 RIEGEL 1 NP/TP 1X RASTUNG ZU

▼ Features

- › Steel bolt
 - › For doors hinged on the left or right
 - › Can be locked in open position with padlocks
 - › Actuator included
 - › Detent mechanism closed position
-

Instructions

▼ Betriebsanleitung Sicherheitsschalter NP...

	Doc. no.	Version	Language	Download
Betriebsanleitung Sicherheitsschalter NP...	083684	07-10/15		 2.0 MB
Manual de instrucciones Interruptores de seguridad NP...				
Mode d'emploi Interrupteur de sécurité NP...				
Istruzioni di impiego Finecorsa di sicurezza NP...				
Operating Instructions Safety Switch NP...				

Catalogs

▼ Bezpečnostní spínače s plastovým pouzdrém Sicherheitsschalter mit Kunststoffgehäuse Safety Switches with Plastic Housing Interruptores de seguridad con carcasa plástica Interrupteurs de sécurité avec boîtier plastique 塑料壳体 的安全开关

	Doc. no.	Version	Language	Download
Sicherheitsschalter mit Kunststoffgehäuse	096955	11-03/18		 6.6 MB
Interrupteurs de sécurité avec boîtier plastique	100677	11-03/18		 6.6 MB
Interruptores de seguridad con carcasa plástica	104855	11-03/18		 6.6 MB
Bezpečnostní spínače s plastovým pouzdrém	121649	11-03/18		 6.6 MB
Safety Switches with Plastic Housing	096956	11-03/18		 6.6 MB
塑料壳体 的安全开关	116243	11-03/18		 6.2 MB

Declaration of conformity

▼ EU prohlášení o shodě

	Doc. no.	Version	Language	Download
EU-Konformitätserklärung Declaración UE de conformidad Déclaration UE de conformité Dichiarazione di conformità EU declaration of conformity	2077153	25-02/17	    	 0.3 MB
EU prohlášení o shodě EU-overensstemmelseserklæring Δήλωση συμμόρφωσης της ΕΕ EU-vaatimustenmukaisuusvakuutus EU-típusbizonyítvány EU-conformiteitsverklaring Deklaracja zgodności UE Declaração de Conformidade UE Declarația de conformitate UE EÚ vyhlásenie o zhode	2077153	25-02/17	        	 0.5 MB

CAD data

CAD data for this item on TraceParts

