

ITEM 092624 NX1-2131A-M

Description	Technical data	Accessories	Downloads
-------------	----------------	-------------	-----------



Features

- › Cable entry M20 x 1.5

Approach direction

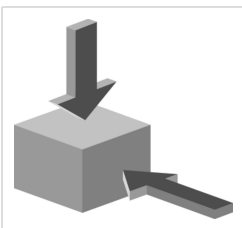

- › Figure
Horizontal and vertical
Can be adjusted in 90° steps

Switching element

2131 Slow-action switching contact 3 NC \ominus + 1 NO

Approvals



Mechanical values and environment

Housing material	Die-cast alloy cathodically dipped
Weight	Net 0,4 kg
Ambient temperature	-20 ... 80 °C
Degree of protection	IP67
Mechanical life	2×10^6
Contact material	Silver alloy, gold flashed
Switching principle	Slow-action switching contact
Installation position	Any
Number of door position positively driven contacts	3
Connection	3 x M20 x 1.5
Approach speed	max.20 m/min
Actuation frequency	1200 1/h
Retention force	10 N
Extraction force	50 N
Actuating force	40 N
Insertion depth	32 mm

Electrical connection ratings

Rated thermal current I_{th}	4 A
Utilization category according to EN 60947-5-1	AC-15 4A 230V DC-13 4A 24V
Short circuit protection according to IEC 60269-1	(Fuse) 4A gG
Rated insulation voltage U_i	AC/DC 250 V
Rated impulse withstand voltage U_{imp}	2,5 kV
Switching voltage	12 V
Switching current	Min. at 24V 1 mA
Connection cross-section	0,34 ... 1,5 mm ²

Reliability values acc. to EN ISO 13849-1

	Monitoring of the safety guard position
B10 _D	4,5 x 10 ⁶

in combination with Actuator BETAETIGER-X-GQ, 079740

Mechanical values and environment

Overtravel	1 mm
------------	------

in combination with Actuator BETAETIGER-X-GNQ, 079742, 098082, 097906

Mechanical values and environment

Overtravel	8 mm
------------	------

Dimension drawing

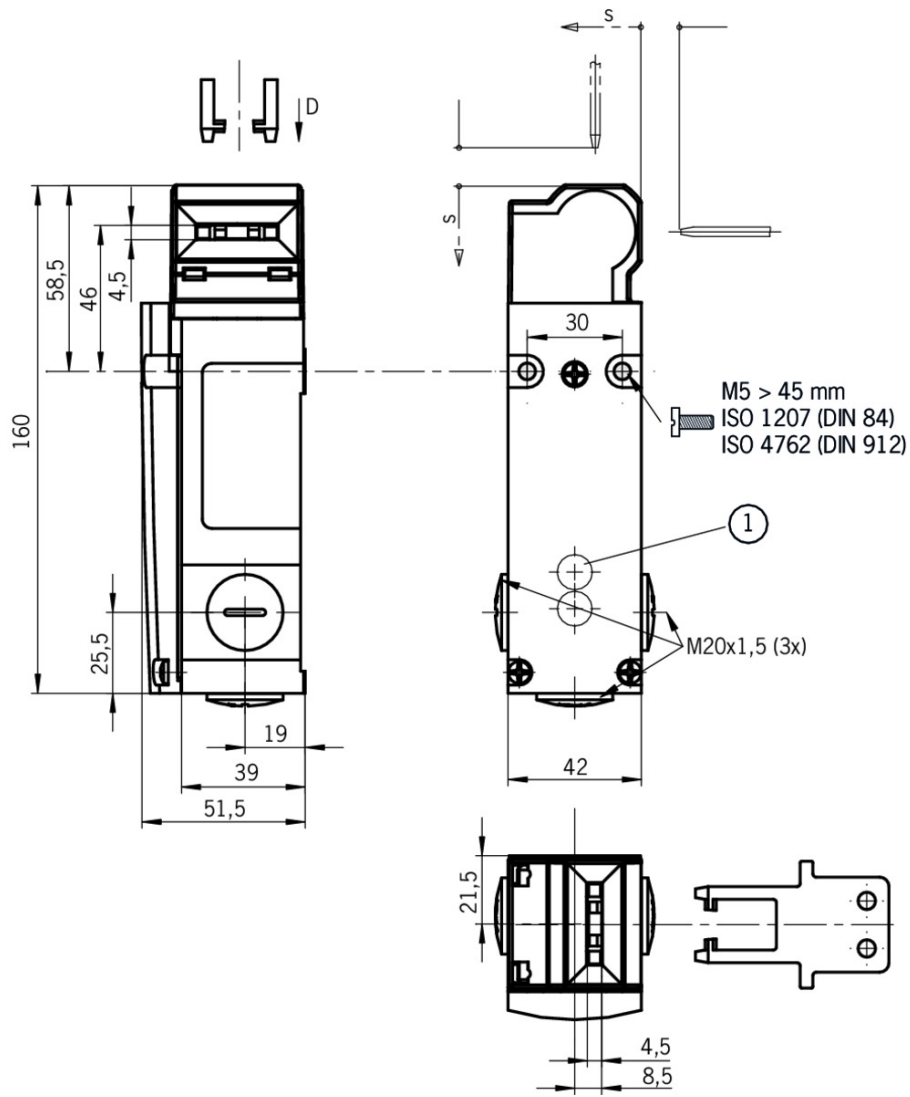

Legende

1 LED indicator

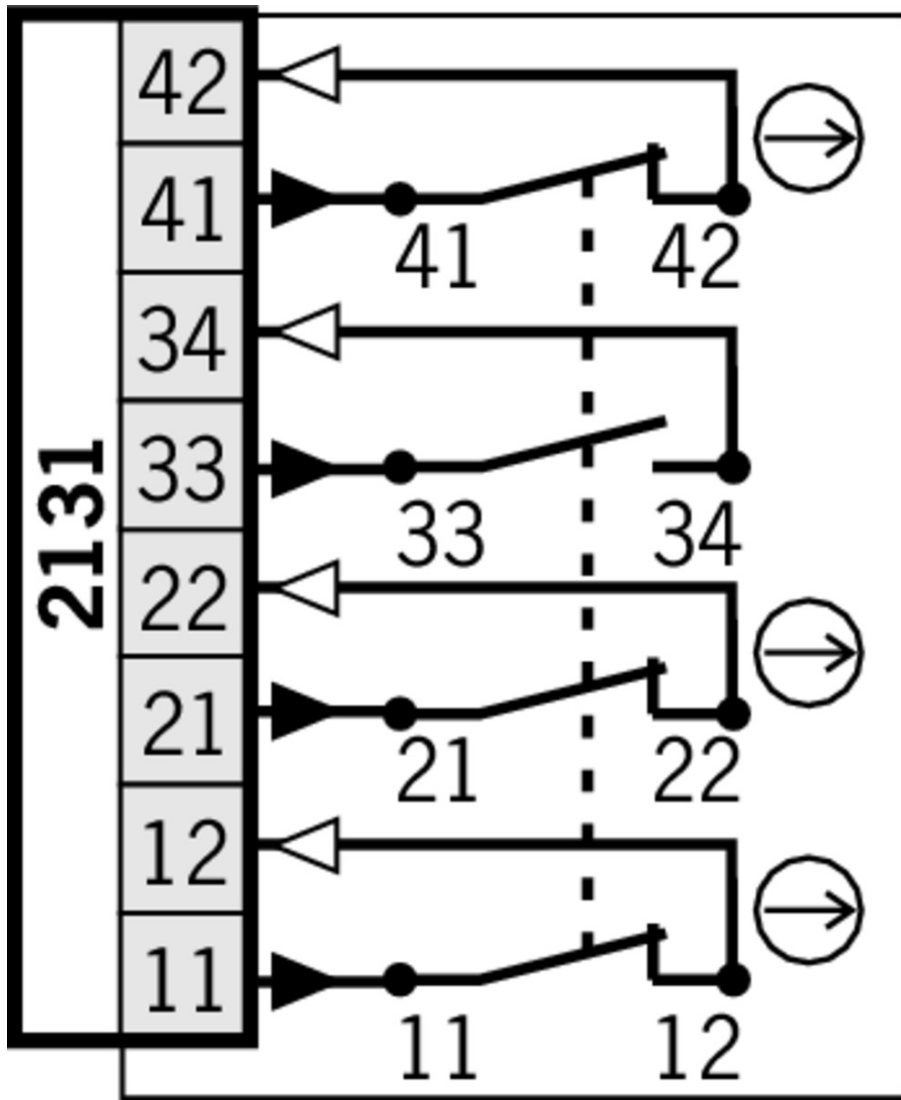

Switching functions

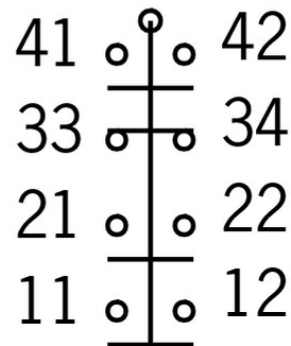
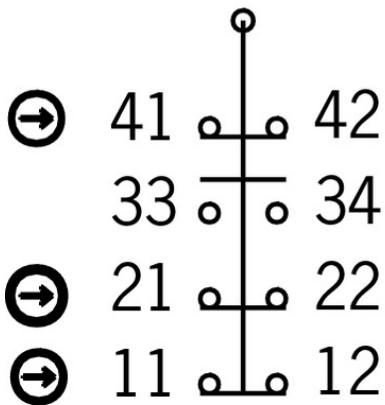
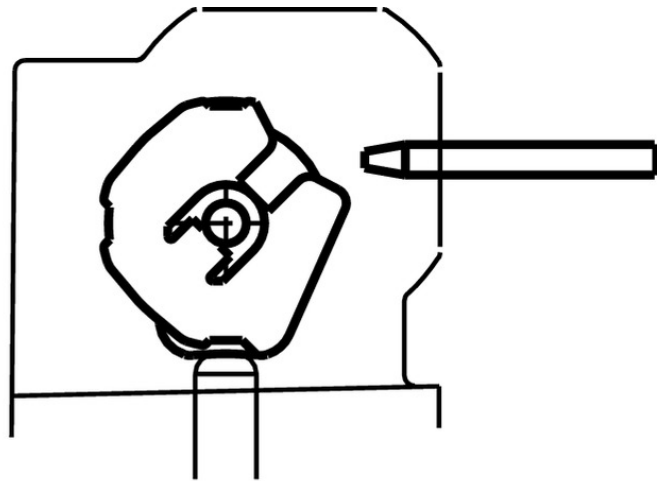
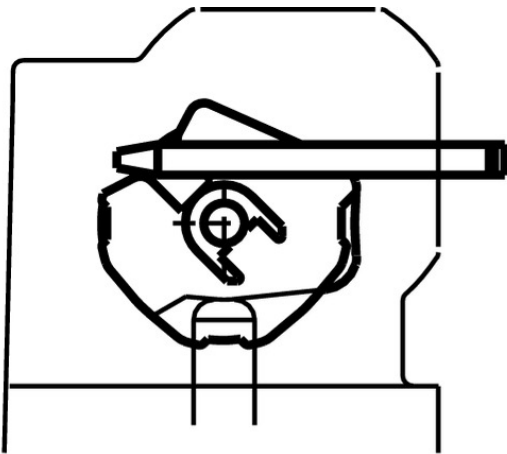

Function expansion

Lockout mechanism NX/TX



096098 SPERREINSATZ TX

Features

- › Prevents unintentional closing of the door
- › Can be secured with padlocks

Bolt

Bolt TX-C for safety switches TX and NX



082991 RIEGEL TX-C

Features

- › Steel bolt
- › For doors hinged on the left
- › Can be locked in open position with padlocks
- › Actuator and switch bracket included

Bolt TX-A for safety switches TX and NX



082990 RIEGEL TX-A

✓ Features

- › Steel bolt
 - › For doors hinged on the right
 - › Can be locked in open position with padlocks
 - › Actuator and switch bracket included
-

Actuator

✓ Hinged actuator top/bottom for safety switches NX/TX



097906 RADIUSBETAETIGER-X-OU-N

✓ Features

- › Actuators made of stainless steel
 - › Two stainless safety screws per actuator
-

✓ Bent actuator for safety switches NX/TX



079740 BETAETIGER-X-WQ

✓ Features

- › Actuators made of stainless steel
 - › Two stainless safety screws per actuator
 - › With rubber bush
-

✓ Actuators for safety switches NX/TX



079739 BETAETIGER-X-GQ

✓ Features

- › Actuators made of stainless steel
 - › Two stainless safety screws per actuator
 - › With rubber bush
-

✓ Actuators for safety switches NX/TX, increased overtravel



079741 BETAETIGER-X-GNQ

✓ Features

- › Actuators made of stainless steel
 - › Two stainless safety screws per actuator
 - › With rubber bush
-

✓ Hinged actuator left/right for safety switches NX/TX



098082 RADIUSBETAETIGER-X-LR-N

✓ Features

- › Actuators made of stainless steel
 - › Two stainless safety screws per actuator
-

✓ Bent actuator for safety switches NX/TX, increased overtravel



079742 BETAETIGER-X-WNQ

Features

- › Actuators made of stainless steel
- › Two stainless safety screws per actuator
- › With rubber bush

Connection material

Cable glands M20x1.5



077683 EKVM20/06



077684 EKVM20/09

Instructions

Betriebsanleitung Sicherheitsschalter NX...

	Doc. no.	Version	Language	Download
Betriebsanleitung Sicherheitsschalter NX...	093784	05-08/15		1.2 MB
Mode d'emploi Interrupteur de sécurité NX...				
Istruzioni di impiego Finecorsa di sicurezza NX...				
Operating Instructions Safety Switches NX...				

Catalogs

















Sicherheitsschalter mit Metallgehäuse Safety Switches with Metal Housing Bezpečnostní spínače s kovovým pouzdrém Interrupteurs de sécurité avec boîtier métallique 金属壳体的安全开关 Interruptores de seguridad con carcasa metálica

	Doc. no.	Version	Language	Download
Sicherheitsschalter mit Metallgehäuse	100319	11-03/18		7.9 MB
Interrupteurs de sécurité avec boîtier métallique	100676	11-03/18		7.9 MB
Interruptores de seguridad con carcasa metálica	104856	11-03/18		14.0 MB
Safety Switches with Metal Housing	100369	11-03/18		7.9 MB
Bezpečnostní spínače s kovovým pouzdrém	121650	11-03/18		7.9 MB
金属壳体的安全开关	102453	11-03/18		8.2 MB

Declaration of conformity

EU prohlášení o shodě

Doc. no.	Version	Language	Download
----------	---------	----------	----------

EU-Konformitätserklärung	2077153	25-02/17		 0.3 MB
Declaración UE de conformidad				
Déclaration UE de conformité				
Dichiarazione di conformità				
EU declaration of conformity				
EU prohlášení o shodě	2077153	25-02/17		 0.5 MB
EU-overensstemmelseserklæring				
Δήλωση συμμόρφωσης της ΕΕ				
EU-vaatimustenmukaisuusvakuutus				
EU-típusbizonyítvány				
EU-conformiteitsverklaring				
Deklaracja zgodności UE				
Declaração de Conformidade UE				
Declarația de conformitate UE				
EÚ vyhlásenie o zhode				

CAD data

CAD data for this item on TraceParts