

**ITEM 077229 NZ2VZ-538EC1233**

Description	Technical data	Accessories	Downloads
-------------	----------------	-------------	-----------

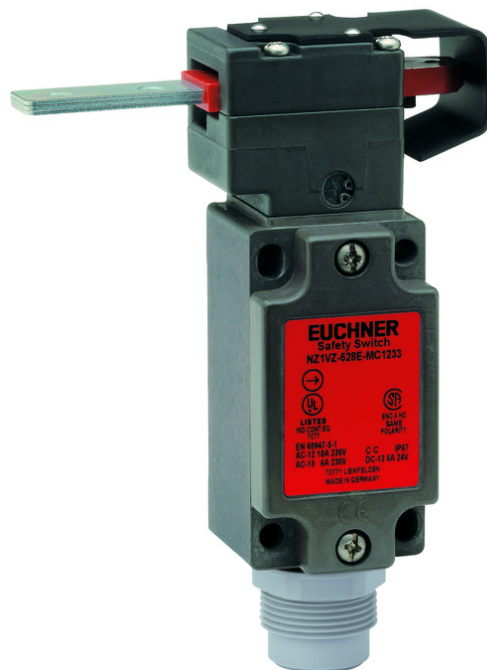

**Features**

- › Housing according to EN 50041
- › Protective plate for switch head
- › Plug connector SR6

**Approach direction**

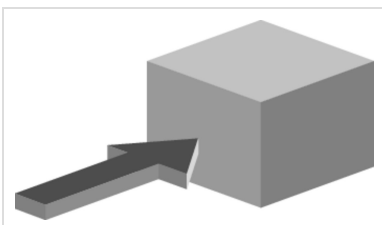

- › Figure  
Horizontal  
Can be adjusted in 90° steps

**Protective plate for switch head**

- › Makes it more difficult to tamper with the switch.

## Switching element

538H Slow-action switching contact 2 NC $\ominus$

## Approvals



## Mechanical values and environment

Housing material	Anodized die-cast alloy
Weight	Net 0,3 kg
Ambient temperature	-25 ... 80 °C
Degree of protection	IP65
Mechanical life	2 x 10 <sup>6</sup>
Contact material	Silver alloy, gold flashed
Switching principle	Slow-action switching contact
Installation position	Any
Number of door position positively driven contacts	2
Connection	1 x Plug connector SR6 [1]
Approach speed	max.20 m/min
Actuation frequency	1200 1/h
Retention force	8 N
Extraction force	35 N
Actuating force	35 N
Insertion depth	52 mm

## Electrical connection ratings

Rated thermal current $I_{th}$	4 A [2]
Utilization category according to EN 60947-5-1	AC-15 4A 230V [3] DC-13 4A 24V [4]
Short circuit protection according to IEC 60269-1	(Fuse) 4A gG [5]
Rated insulation voltage $U_i$	AC/DC 250 V
Rated impulse withstand voltage $U_{imp}$	2,5 kV
Switching voltage	Min. at 10mA 12 V

Switching current	Min. at 24V	1 mA
-------------------	-------------	------

### Miscellaneous

C number	C1233	[6]
----------	-------	-----

### Reliability values acc. to EN ISO 13849-1

	Monitoring of the safety guard position	
B10 <sub>D</sub>		4,5 x 10 <sup>6</sup>

---

### in combination with Actuator BETAETIGER-Z-G

#### Mechanical values and environment

Overtravel	4 mm
------------	------

### in combination with Actuator BETAETIGER-Z-GN

#### Mechanical values and environment

Overtravel	16 mm
------------	-------

[1] 6-pin + PE

[2, 3, 4] > 70° C => 2 A

[5] > 70° C => 2 A gG

[6] With cover plate



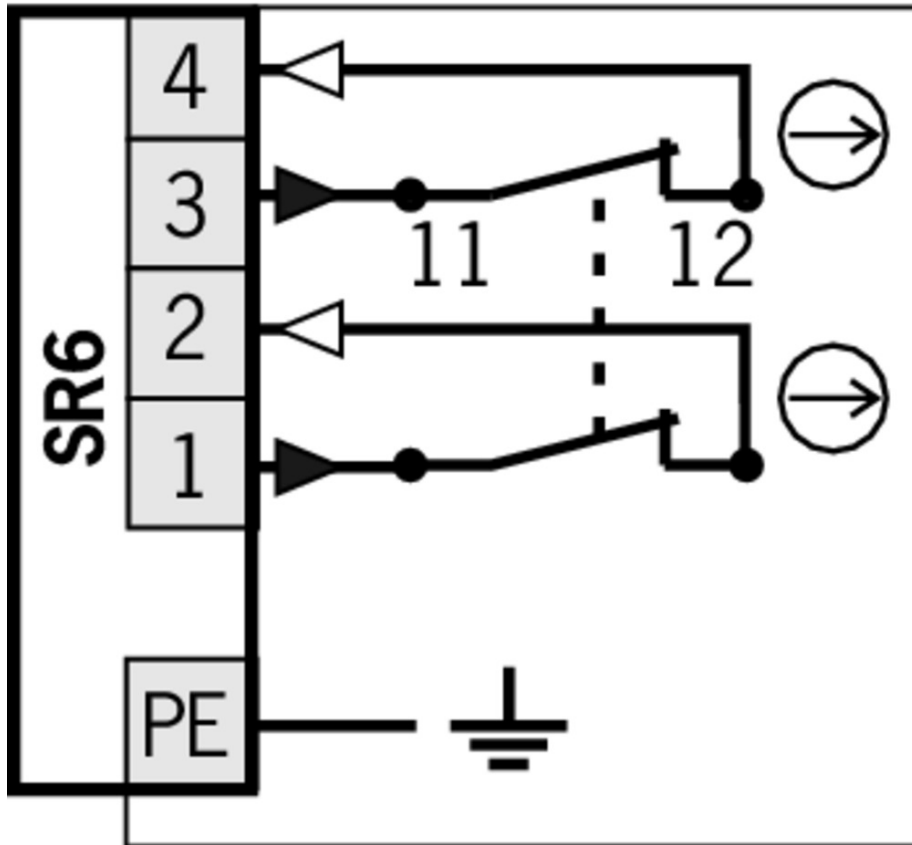

## Switching functions

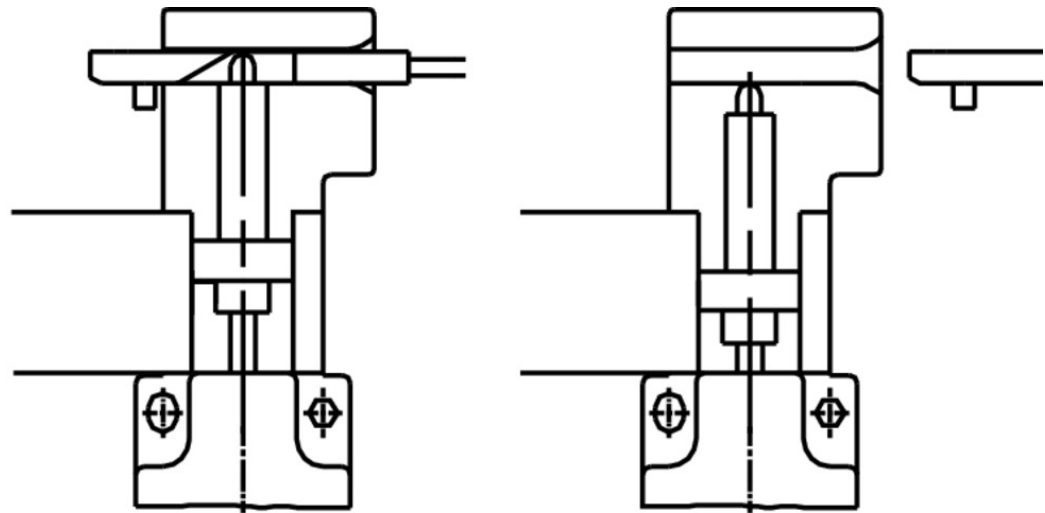

## Actuator

- Hinged actuator right for safety switches NZ.VZ, NZ.VZ.VS and TZ



**024299** RADIUSBETAETIGER-Z-R

Features

- › Two stainless safety screws per actuator



**074412** RADIUSBETAETIGER-Z-R/V25

Features

- › Two stainless safety screws per actuator
- › Packaging unit 25 pieces



**100406** RADIUSBETAETIGER-Z-R-C2194

Features

- › Two stainless safety screws per actuator
- › Smaller door radii

- Hinged actuator left for safety switches NZ.VZ, NZ.VZ.VS and TZ



**100407** RADIUSBETAETIGER-Z-L-C2194

Features

- › Two stainless safety screws per actuator
- › Smaller door radii



**074413** RADIUSBETAETIGER-Z-L/V25

✓ Features

- › Two stainless safety screws per actuator
- › Packaging unit 25 pieces



**024298** RADIUSBETAETIGER-Z-L

✓ Features

- › Two stainless safety screws per actuator

✓ Actuators for safety switches NZ.VZ, NZ.VZ.VS and TZ



**074411** BETAETIGER-Z-G/V25

✓ Features

- › Two stainless safety screws per actuator
- › Packaging unit 25 pieces



**097436** BETAETIGER-Z-GME

✓ Features

- › Made of solid stainless steel
- › Two stainless safety screws per actuator



**072251** BETAETIGER-Z-GN

✓ Features

- › Two stainless safety screws per actuator



**016849** BETAETIGER-Z-G

✓ Features

- › Two stainless safety screws per actuator

✓ Hinged actuator bottom for safety switches NZ.VZ, NZ.VZ.VS and TZ



**048850** RADIUSBETAETIGER-Z-U

✓ Features

- › Two stainless safety screws per actuator



**074414** RADIUSBETAETIGER-Z-U/V25

✓ Features

- › Two stainless safety screws per actuator
- › Packaging unit 25 pieces

✓ Hinged actuator top for safety switches NZ.VZ, NZ.VZ.VS and TZ



**057950** RADIUSBETAETIGER-Z-O

✓ Features

- › Two stainless safety screws per actuator

**074415** RADIUSBETAETIGER-Z-O/V25



- ✓ Features
    - › Two stainless safety screws per actuator
    - › Packaging unit 25 pieces
- 

## Bolt

---

- ✓ Bolt NZ-A... for safety switches NZ.VZ and NZ.VZ.VS



### **078455** RIEGEL NZ-AR2

- ✓ Features
    - › Steel bolt
    - › For doors hinged on the right
    - › Detent knob in open position
    - › Detent knob in closed position
    - › Can be locked in open position with padlocks
    - › Actuator and switch bracket included
- 



### **083890** RIEGEL NZ-AB

- ✓ Features
    - › Steel bolt
    - › For doors hinged on the right
    - › Ball detent mechanism in closed position
    - › Can be locked in open position with padlocks
    - › Actuator and switch bracket included
- 

- ✓ Bolt NZ-C... for safety switches NZ.VZ and NZ.VZ.VS



### **078456** RIEGEL NZ-CR2

- ✓ Features
    - › Steel bolt
    - › For doors hinged on the left
    - › Detent knob in open position
    - › Detent knob mechanism in closed position
    - › Can be locked in open position with padlocks
    - › Actuator and switch bracket included
- 



### **083892** RIEGEL NZ-CB

- ✓ Features
    - › Steel bolt
    - › For doors hinged on the left
    - › Ball detent mechanism in closed position
    - › Can be locked in open position with padlocks
    - › Actuator and switch bracket included
- 

- ✓ Bolt NZ-AF with escape release for safety switches NZ.VZ



### **078451** RIEGEL NZ-AF

- ✓ Features
  - › Steel bolt
  - › For doors hinged on the right
  - › Lever for escape release from the danger zone



- › Detent knob in open position
  - › Can be locked in open position with padlocks
  - › Actuator and switch bracket included
- 

▼ Bolt NZ-CF with escape release for safety switches NZ.VZ



**078452** RIEGEL NZ-CF

▼ Features

- › Steel bolt
  - › For doors hinged on the left
  - › Lever for escape release from the danger zone
  - › Detent knob in open position
  - › Can be locked in open position with padlocks
  - › Actuator and switch bracket included
- 

▼ Bolts NZ/TZ-S1 and NZ/TZ-S2 for safety switches NZ.VZ, NZ.VZ.VS and TZ



**028359** RIEGEL NZ/TZ-S2

▼ Features

- › Aluminum bolt
  - › For doors hinged on the left or right. Cone grip top.
  - › Spring catch in open position
  - › Can be locked in open position with padlocks
  - › Actuator included
- 



**028357** RIEGEL NZ/TZ-S1

▼ Features

- › Aluminum bolt
  - › For doors hinged on the left or right. Cone grip bottom.
  - › Spring catch in open position
  - › Can be locked in open position with padlocks
  - › Actuator included
- 

▼ Bolts NZ/TZ-S1/AF and NZ/TZ-S1/CF with escape release for safety switches NZ.VZ, NZ.VZ.VS and TZ with escape release



**079786** RIEGEL NZ/TZ-S1/AF

▼ Features

- › Aluminum bolt
  - › For doors hinged on the right
  - › Escape release
  - › Spring catch in open position
  - › Can be locked in open position with padlocks
  - › Actuator included
- 



**079785** RIEGEL NZ/TZ-S1/CF

▼ Features

- › Aluminum bolt
- › For doors hinged on the left
- › Escape release
- › Spring catch in open position
- › Can be locked in open position with padlocks
- › Actuator included

- 
- ▼ Bolt NZ/TZ-ACF with escape release for safety switches NZ.VZ and TZ with escape release



**083900** RIEGEL NZ/TZ-ACF

▼ Features

- › Steel bolt
- › For doors hinged on the right or left
- › Lever for escape release from the danger area
- › Detent knob in open position
- › Can be locked in open position with padlocks
- › Bolt for two safety switches
- › Actuator included

- 
- ▼ Bolt BTC-NZVZ... with escape release for safety switches NZ.VZ and NZ.VZ.VS



**104399** BTC-NZVZ-S-TH-01-F

▼ Features

- › Die-cast aluminum bolt
- › For left or right hinged doors
- › Lever for escape release from the danger area
- › Can be locked in open position with padlocks
- › Actuator included

- 
- ▼ Bolt BTC-NZVZ... without escape release for safety switches NZ.VZ and NZ.VZ.VS



**104398** BTC-NZVZ-S-TH-00-X

▼ Features

- › Die-cast aluminum bolt
- › For left or right hinged doors
- › Can be locked in open position with padlocks
- › Actuator included

- 
- ▼ Bolt NZ-C for safety switches NZ.VZ and NZ.VZ.VS



**057735** RIEGEL NZ-C

▼ Features

- › Steel bolt
- › For doors hinged on the left
- › Can be locked in open position with padlocks
- › Actuator and switch bracket included

- 
- ▼ Bolt NZ-A for safety switches NZ.VZ and NZ.VZ.VS



**057734** RIEGEL NZ-A

▼ Features

- › Steel bolt
  - › For doors hinged on the right
  - › Can be locked in open position with padlocks
  - › Actuator and switch bracket included
  - › Bolt is not allowed to be used in conjunction with an escape release.
-

- ▼ Bolt NZ-GFK for safety switch NZ.VZ



**096617** RIEGEL NZ-GFK

- ▼ Features

- › Fiber glass reinforced plastic bolt
- › For doors hinged on the left or right
- › Can be locked in open position with padlocks
- › Actuator included

---

## Spare parts

- ▼ Replacement head NZ.VZ

**076250** BETAETIGUNGSKOPF NZVZ

---

## Function expansion

- ▼ LED function display NZ



**029220** NGLE060RT



**029221** NGLE060GR

- ▼ Protective plate NZ.VZ/TZ

**059136** SCHUTZBLECH NZ/TZ

---

## Mounting accessories

- ▼ Mounting plates EMP-B2 for actuators for safety switches CTP, TP...A, STA, STP, TX and TZ



**093458** EMP-B2

- ▼ Mounting plates EMP-B1 for actuators for safety switches CTP, TP...A, STA, STP, TX and TZ



**093457** EMP-B1

- ▼ Mounting plates EMP-SC for safety switches NM, NP...AS and NZ



**085753** EMP-SC

- ▼ Features

- › For vertical and horizontal mounting of safety switches NM, NP...AS and NZ

---

▼ Safety screws M4 x 14

**074063** M4X14/V100

▼ Features

- › Safety screws M4 x 14
  - › Packaging unit 100 pieces
- 

▼ Safety screws for actuators, M5 x 10

**073455** M5X10-NIRO/V100 NZ/TZ

▼ Features

- › Safety screws M5 x 10
  - › Packaging unit 100 pieces
- 

▼ Safety screws for actuators, M5 x 16

**073456** M5X16/V100

▼ Features

- › Safety screws M5 x 16
  - › Packaging unit 100 pieces
- 

▼ Safety screws M5 x 25

**073457** M5X25/V100





▼ Features

- › Safety screws M5 x 25
  - › Packaging unit 100 pieces
- 

## Instructions













▼ Käyttöohje Turvakytkimet NZ.VZ

	Doc. no.	Version	Language	Download
Betriebsanleitung Sicherheitschalter NZ.VZ Manual de instrucciones Interruptores de seguridad NZ.VZ Mode d'emploi Interrupteur de sécurité NZ.VZ Operating Instructions Safety Switch NZ.VZ	2094060	08-06/17	   	 1.6 MB
Käyttöohje Turvakytkimet NZ.VZ	2094060	08-06/17		 0.4 MB
Istruzioni di impiego Finecorsa di sicurezza NZ.VZ	2094060	08-06/17		 0.5 MB
Instrukcja obsługi Wyłącznik bezpieczeństwa NZ.VZ	2094060	08-06/17		 0.5 MB
Инструкция по эксплуатации Предохранительный выключатель NZ.VZ	2094060	08-06/17		 0.6 MB

Návod na prevádzku Bezpečnostný spínač NZ.VZ	2094060	08-06/17		 0.5 MB
Instruktionsbok Säkerhetsbrytare NZ.VZ	2094060	08-06/17		 0.5 MB

## Catalogs

- Sicherheitsschalter mit Metallgehäuse Safety Switches with Metal Housing Bezpečnostní spínače s kovovým pouzdrém Interrupteurs de sécurité avec boîtier métallique 金属壳体 的安全开关 Interruptores de seguridad con carcasa metálica

	Doc. no.	Version	Language	Download
Sicherheitsschalter mit Metallgehäuse	100319	11-03/18		 7.9 MB
Interrupteurs de sécurité avec boîtier métallique	100676	11-03/18		 7.9 MB
Interruptores de seguridad con carcasa metálica	104856	11-03/18		 14.0 MB
Safety Switches with Metal Housing	100369	11-03/18		 7.9 MB
Bezpečnostní spínače s kovovým pouzdrém	121650	11-03/18		 7.9 MB
金属壳体 的安全开关	102453	11-03/18		 8.2 MB

## Declaration of conformity

- EU prohlášení o shodě

	Doc. no.	Version	Language	Download
EU-Konformitätserklärung Declaración UE de conformidad Déclaration UE de conformité Dichiarazione di conformità EU declaration of conformity	2077153	25-02/17	    	 0.3 MB
EU prohlášení o shodě EU-overensstemmelseserklæring Δήλωση συμμόρφωσης της ΕΕ EU-vaatimustenmukaisuusvakuutus EU-típusbizonyítvány EU-conformiteitsverklaring Deklaracja zgodności UE Declaração de Conformidade UE Declarația de conformitate UE EÚ vyhlásenie o zhode	2077153	25-02/17	        	 0.5 MB

## CAD data

CAD data for this item on TraceParts