

ITEM 089914 NZ1VZ-2121E-MC1233

Description	Technical data	Accessories	Downloads
-------------	----------------	-------------	-----------

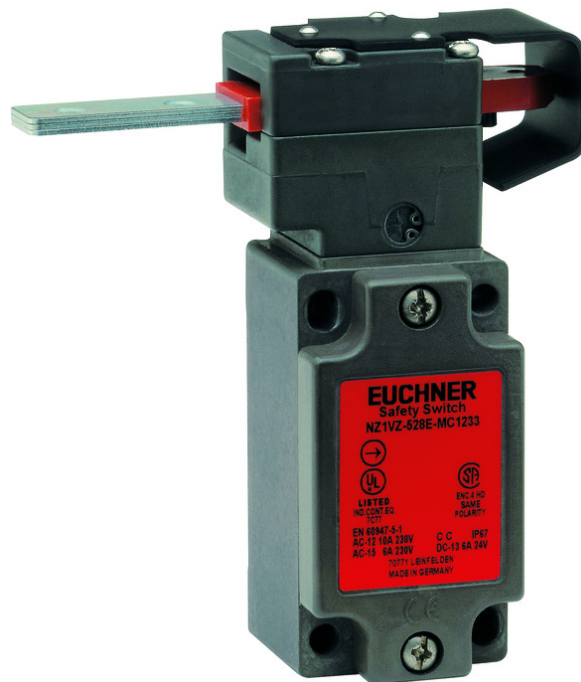

Features

- › Housing according to EN 50041
- › Protective plate for switch head
- › Cable entry M20 x 1.5

Approach direction

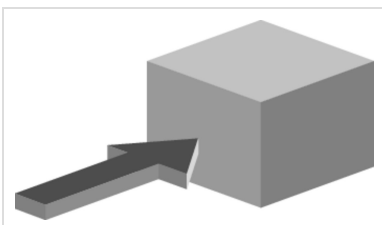

- › Figure
Horizontal
Can be adjusted in 90° steps

Protective plate for switch head

- › Makes it more difficult to tamper with the switch.

Switching element

2121H Slow-action switching contact 4 NC ⊕

Approvals



Mechanical values and environment

Housing material	Anodized die-cast alloy
Weight	Net 0,3 kg
Ambient temperature	-25 ... 80 °C
Degree of protection	IP67
Mechanical life	2 x 10 ⁶
Contact material	Silver alloy, gold flashed
Switching principle	Slow-action switching contact
Installation position	Any
Number of door position positively driven contacts	4
Connection	1 x M20 x 1.5
Approach speed	max.20 m/min
Actuation frequency	1200 1/h
Retention force	8 N
Extraction force	35 N
Actuating force	35 N
Insertion depth	52 mm

Electrical connection ratings

Rated thermal current I _{th}	4 A
Utilization category according to EN 60947-5-1	AC-15 4A 230V DC-13 4A 24V
Short circuit protection according to IEC 60269-1	(Fuse) 4A gG
Rated insulation voltage U _i	AC/DC 250 V
Rated impulse withstand voltage U _{imp}	2,5 kV
Switching voltage	Min. at 10mA 12 V

Switching current	Min. at 24V	1 mA
Connection cross-section		0,34 ... 1,5 mm ²

Miscellaneous

C number	C1233	[1]
----------	-------	-----

Reliability values acc. to EN ISO 13849-1

	Monitoring of the safety guard position	
B10 _D		4,5 x 10 ⁶

in combination with Actuator BETAETIGER-Z-G

Mechanical values and environment

Overtravel	4 mm
------------	------

in combination with Actuator BETAETIGER-Z-GN

Mechanical values and environment

Overtravel	16 mm
------------	-------

[1] With cover plate

Dimension drawing

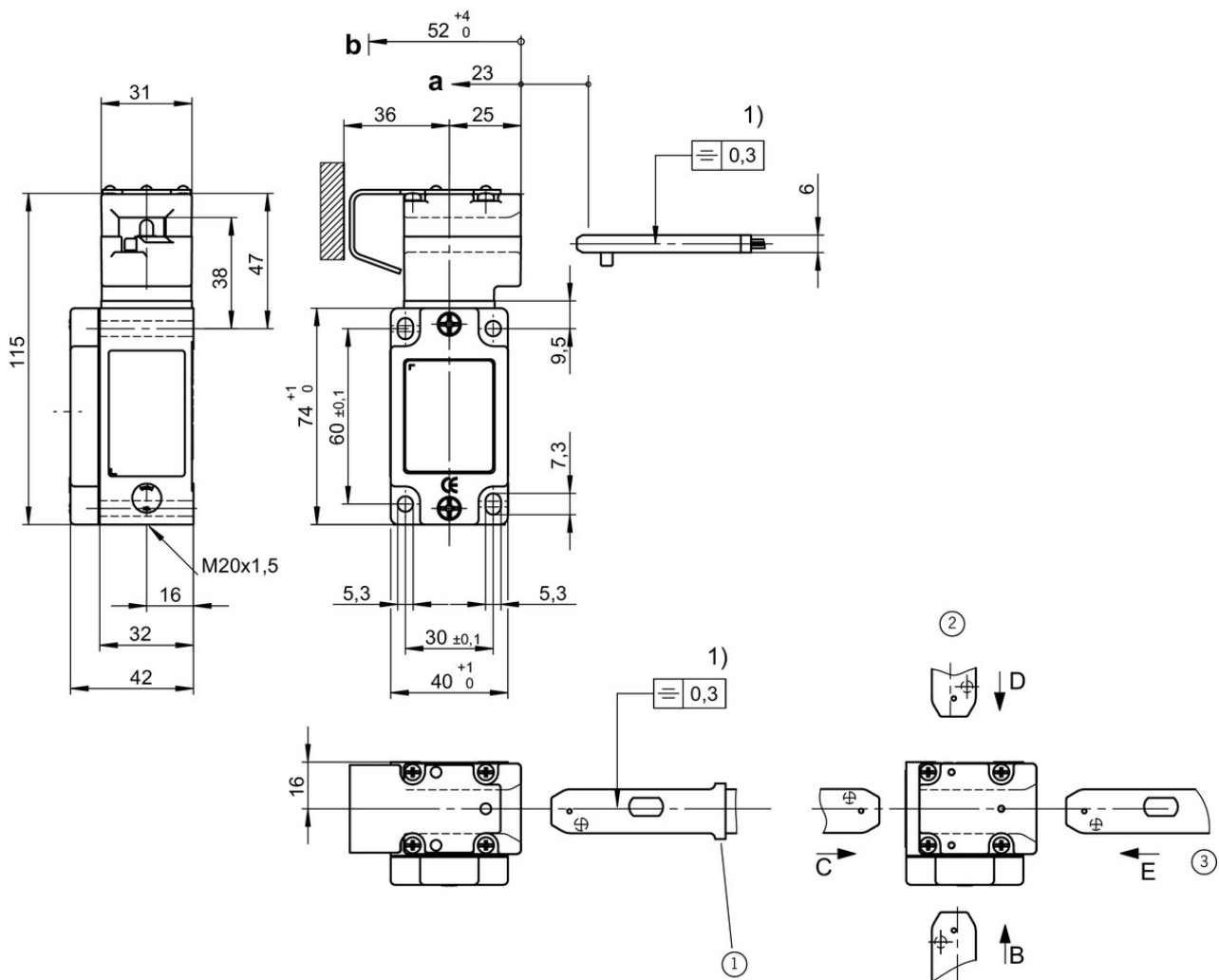

Legende

- a Travel without operation: actuator is in the guide slot, but function is not triggered.
- b Switching operation completed: actuator must be inserted to this point to ensure reliable switching. The actuator must be withdrawn at least to point a for switching off.
- 1) Order actuator separately. The safety switch and actuator must be placed together for attachment to the machine. Do not use actuator as an end stop. Limit overtravel separately.
- 2 Actuating direction can be changed
- 3 Standard

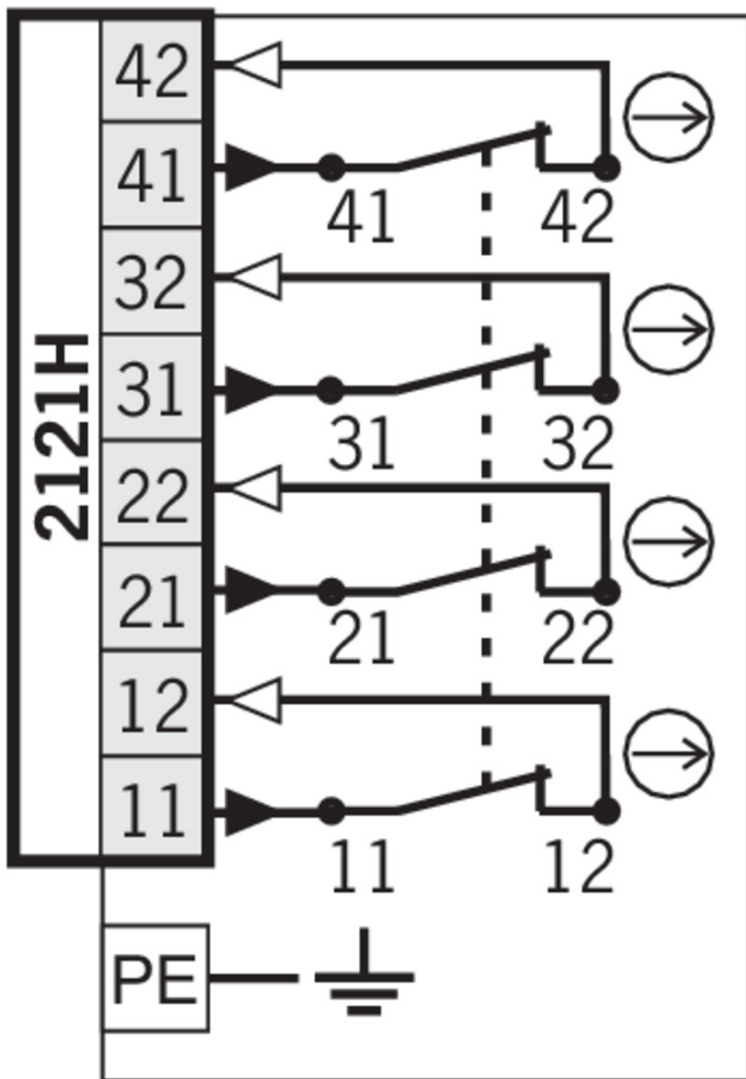

Switching functions

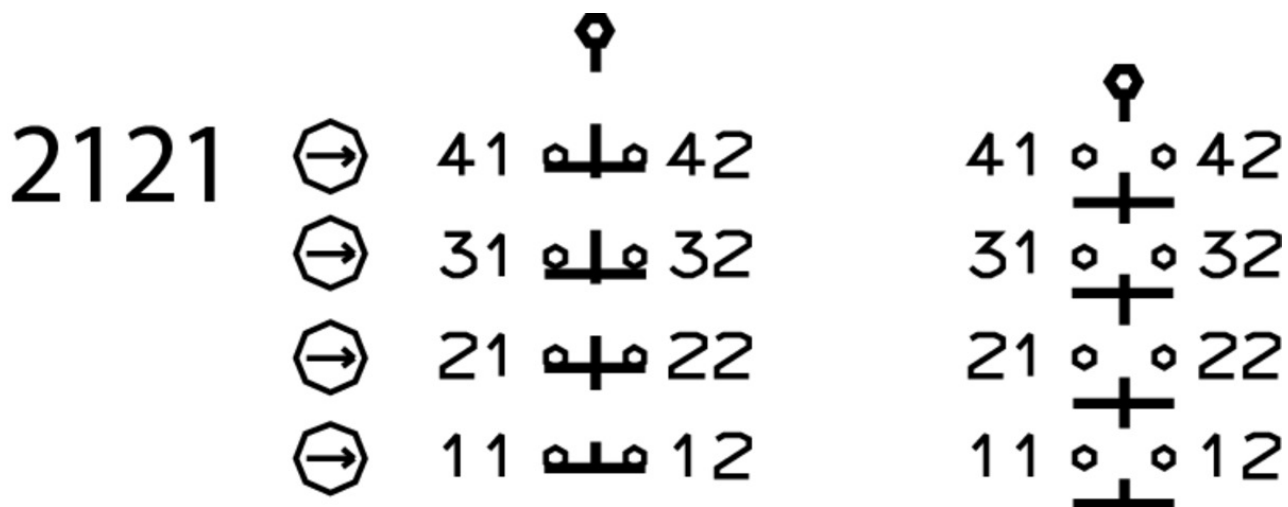

Actuator



016849 BETAETIGER-Z-G

✓ Features

- › Two stainless safety screws per actuator



074411 BETAETIGER-Z-G/V25

✓ Features

- › Two stainless safety screws per actuator
- › Packaging unit 25 pieces



097436 BETAETIGER-Z-GME

✓ Features

- › Made of solid stainless steel
- › Two stainless safety screws per actuator



072251 BETAETIGER-Z-GN

✓ Features

- › Two stainless safety screws per actuator

✓ Hinged actuator right for safety switches NZ.VZ, NZ.VZ.VS and TZ



024299 RADIUSBETAETIGER-Z-R

✓ Features

- › Two stainless safety screws per actuator



074412 RADIUSBETAETIGER-Z-R/V25

✓ Features

- › Two stainless safety screws per actuator
- › Packaging unit 25 pieces



100406 RADIUSBETAETIGER-Z-R-C2194

✓ Features

- › Two stainless safety screws per actuator
- › Smaller door radii

✓ Hinged actuator left for safety switches NZ.VZ, NZ.VZ.VS and TZ



074413 RADIUSBETAETIGER-Z-L/V25

✓ Features

- › Two stainless safety screws per actuator
- › Packaging unit 25 pieces



100407 RADIUSBETAETIGER-Z-L-C2194

✓ Features

- › Two stainless safety screws per actuator
- › Smaller door radii



024298 RADIUSBETAETIGER-Z-L

- ▼ Features
 - › Two stainless safety screws per actuator
-

▼ Hinged actuator top for safety switches NZ.VZ, NZ.VZ.VS and TZ



074415 RADIUSBETAETIGER-Z-O/V25

- ▼ Features
 - › Two stainless safety screws per actuator
 - › Packaging unit 25 pieces
-



057950 RADIUSBETAETIGER-Z-O

- ▼ Features
 - › Two stainless safety screws per actuator
-

▼ Hinged actuator bottom for safety switches NZ.VZ, NZ.VZ.VS and TZ



048850 RADIUSBETAETIGER-Z-U

- ▼ Features
 - › Two stainless safety screws per actuator
-



074414 RADIUSBETAETIGER-Z-U/V25

- ▼ Features
 - › Two stainless safety screws per actuator
 - › Packaging unit 25 pieces
-

Bolt

▼ Bolt NZ/TZ-ACF with escape release for safety switches NZ.VZ and TZ with escape release



083900 RIEGEL NZ/TZ-ACF

- ▼ Features
 - › Steel bolt
 - › For doors hinged on the right or left
 - › Lever for escape release from the danger area
 - › Detent knob in open position
 - › Can be locked in open position with padlocks
 - › Bolt for two safety switches
 - › Actuator included
-

▼ Bolt BTC-NZVZ... with escape release for safety switches NZ.VZ and NZ.VZ.VS



104399 BTC-NZVZ-S-TH-01-F

- ▼ Features
 - › Die-cast aluminum bolt
 - › For left or right hinged doors
 - › Lever for escape release from the danger area
 - › Can be locked in open position with padlocks
 - › Actuator included
-

▼ Bolt BTC-NZVZ... without escape release for safety switches NZ.VZ and NZ.VZ.VS



104398 BTC-NZVZ-S-TH-00-X

▼ Features

- › Die-cast aluminum bolt
 - › For left or right hinged doors
 - › Can be locked in open position with padlocks
 - › Actuator included
-

▼ Bolts NZ/TZ-S1 and NZ/TZ-S2 for safety switches NZ.VZ, NZ.VZ.VS and TZ



028357 RIEGEL NZ/TZ-S1

▼ Features

- › Aluminum bolt
 - › For doors hinged on the left or right. Cone grip bottom.
 - › Spring catch in open position
 - › Can be locked in open position with padlocks
 - › Actuator included
-



028359 RIEGEL NZ/TZ-S2

▼ Features

- › Aluminum bolt
 - › For doors hinged on the left or right. Cone grip top.
 - › Spring catch in open position
 - › Can be locked in open position with padlocks
 - › Actuator included
-

▼ Bolts NZ/TZ-S1/AF and NZ/TZ-S1/CF with escape release for safety switches NZ.VZ, NZ.VZ.VS and TZ with escape release



079786 RIEGEL NZ/TZ-S1/AF

▼ Features

- › Aluminum bolt
 - › For doors hinged on the right
 - › Escape release
 - › Spring catch in open position
 - › Can be locked in open position with padlocks
 - › Actuator included
-



079785 RIEGEL NZ/TZ-S1/CF

▼ Features

- › Aluminum bolt
 - › For doors hinged on the left
 - › Escape release
 - › Spring catch in open position
 - › Can be locked in open position with padlocks
 - › Actuator included
-

▼ Bolt NZ-GFK for safety switch NZ.VZ



096617 RIEGEL NZ-GFK

▼ Features

- › Fiber glass reinforced plastic bolt
 - › For doors hinged on the left or right
 - › Can be locked in open position with padlocks
 - › Actuator included
-

▼ Bolt NZ-CF with escape release for safety switches NZ.VZ



078452 RIEGEL NZ-CF

▼ Features

- › Steel bolt
 - › For doors hinged on the left
 - › Lever for escape release from the danger zone
 - › Detent knob in open position
 - › Can be locked in open position with padlocks
 - › Actuator and switch bracket included
-

▼ Bolt NZ-C... for safety switches NZ.VZ and NZ.VZ.VS



083892 RIEGEL NZ-CB

▼ Features

- › Steel bolt
 - › For doors hinged on the left
 - › Ball detent mechanism in closed position
 - › Can be locked in open position with padlocks
 - › Actuator and switch bracket included
-



078456 RIEGEL NZ-CR2

▼ Features

- › Steel bolt
 - › For doors hinged on the left
 - › Detent knob in open position
 - › Detent knob mechanism in closed position
 - › Can be locked in open position with padlocks
 - › Actuator and switch bracket included
-

▼ Bolt NZ-AF with escape release for safety switches NZ.VZ



078451 RIEGEL NZ-AF

▼ Features

- › Steel bolt
 - › For doors hinged on the right
 - › Lever for escape release from the danger zone
 - › Detent knob in open position
 - › Can be locked in open position with padlocks
 - › Actuator and switch bracket included
-

▼ Bolt NZ-A... for safety switches NZ.VZ and NZ.VZ.VS



083890 RIEGEL NZ-AB

▼ Features

- › Steel bolt
- › For doors hinged on the right

- › Ball detent mechanism in closed position
- › Can be locked in open position with padlocks
- › Actuator and switch bracket included



078455 RIEGEL NZ-AR2

✓ Features

- › Steel bolt
- › For doors hinged on the right
- › Detent knob in open position
- › Detent knob in closed position
- › Can be locked in open position with padlocks
- › Actuator and switch bracket included

✓ Bolt NZ-A for safety switches NZ.VZ and NZ.VZ.VS



057734 RIEGEL NZ-A

✓ Features

- › Steel bolt
- › For doors hinged on the right
- › Can be locked in open position with padlocks
- › Actuator and switch bracket included
- › Bolt is not allowed to be used in conjunction with an escape release.

✓ Bolt NZ-C for safety switches NZ.VZ and NZ.VZ.VS



057735 RIEGEL NZ-C

✓ Features

- › Steel bolt
- › For doors hinged on the left
- › Can be locked in open position with padlocks
- › Actuator and switch bracket included

Mounting accessories

✓ Mounting plates EMP-SC for safety switches NM, NP...AS and NZ



085753 EMP-SC

✓ Features

- › For vertical and horizontal mounting of safety switches NM, NP...AS and NZ

✓ Mounting plates EMP-B1 for actuators for safety switches CTP, TP...A, STA, STP, TX and TZ



093457 EMP-B1

✓ Mounting plates EMP-B2 for actuators for safety switches CTP, TP...A, STA, STP, TX and TZ



093458 EMP-B2

▼ Safety screws M4 x 14

074063 M4X14/V100

▼ Features

- › Safety screws M4 x 14
 - › Packaging unit 100 pieces
-

▼ Safety screws for actuators, M5 x 10

073455 M5X10-NIRO/V100 NZ/TZ

▼ Features

- › Safety screws M5 x 10
 - › Packaging unit 100 pieces
-

▼ Safety screws for actuators, M5 x 16

073456 M5X16/V100

▼ Features

- › Safety screws M5 x 16
 - › Packaging unit 100 pieces
-

▼ Safety screws M5 x 25

073457 M5X25/V100

▼ Features

- › Safety screws M5 x 25
 - › Packaging unit 100 pieces
-

Function expansion

▼ Protective plate NZ.VZ/TZ

059136 SCHUTZBLECH NZ/TZ

▼ LED function display NZ



029220 NGLE060RT



029221 NGLE060GR

Spare parts

▼ Replacement head NZ.VZ

076250 BETAETIGUNGSKOPF NZVZ













Instructions

☑ Käyttöohje Turvakytkimet NZ.VZ

	Doc. no.	Version	Language	Download
Betriebsanleitung Sicherheitschalter NZ.VZ Manual de instrucciones Interruptores de seguridad NZ.VZ Mode d'emploi Interrupteur de sécurité NZ.VZ Operating Instructions Safety Switch NZ.VZ	2094060	08-06/17	   	 1.6 MB
Käyttöohje Turvakytkimet NZ.VZ	2094060	08-06/17		 0.4 MB
Istruzioni di impiego Finecorsa di sicurezza NZ.VZ	2094060	08-06/17		 0.5 MB
Instrukcja obsługi Wyłącznik bezpieczeństwa NZ.VZ	2094060	08-06/17		 0.5 MB
Инструкция по эксплуатации Предохранительный выключатель NZ.VZ	2094060	08-06/17		 0.6 MB
Návod na prevádzku Bezpečnostný spínač NZ.VZ	2094060	08-06/17		 0.5 MB
Instruktionsbok Säkerhetsbrytare NZ.VZ	2094060	08-06/17		 0.5 MB







Catalogs











☑ Sicherheitsschalter mit Metallgehäuse Safety Switches with Metal Housing Bezpečnostní spínače s kovovým pouzdem Interrupteurs de sécurité avec boîtier métallique 金属壳体 的安全开关 Interruptores de seguridad con carcasa metálica

	Doc. no.	Version	Language	Download
Sicherheitsschalter mit Metallgehäuse	100319	11-03/18		 7.9 MB
Interrupteurs de sécurité avec boîtier métallique	100676	11-03/18		 7.9 MB
Interruptores de seguridad con carcasa metálica	104856	11-03/18		 14.0 MB
Safety Switches with Metal Housing	100369	11-03/18		 7.9 MB
Bezpečnostní spínače s kovovým pouzdem	121650	11-03/18		 7.9 MB
金属壳体 的安全开关	102453	11-03/18		 8.2 MB

Declaration of conformity

☑ EU prohlášení o shodě

	Doc. no.	Version	Language	Download
EU-Konformitätserklärung Declaración UE de conformidad Déclaration UE de conformité Dichiarazione di conformità EU declaration of conformity	2077153	25-02/17	    	 0.3 MB

EU prohlášení o shodě	2077153	25-02/17		 0.5 MB
EU-overensstemmelseserklæring				
Δήλωση συμμόρφωσης της ΕΕ				
EU-vaatimustenmukaisuusvakuutus				
EU-típusbizonyítvány				
EU-conformiteitsverklaring				
Deklaracja zgodności UE				
Declaração de Conformidade UE				
Declarația de conformitate UE				
EÚ vyhlásenie o zhode				

CAD data

CAD data for this item on TraceParts