

ITEM 059481 NZ2WO-511L060C1630

| Description | Technical data | Accessories | Downloads |
|-------------|----------------|-------------|-----------|
|-------------|----------------|-------------|-----------|



Features

- › Version B according to EN 50041(hardened)
- › Plug connector SR6
- › LED indicator

Approach direction

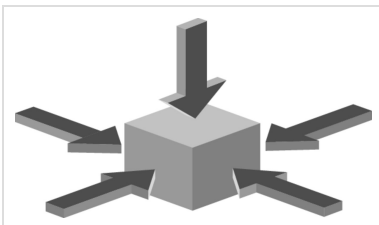

- › Figure
Horizontal and vertical

LED function display

- A function display is available for the following voltage range:
- › AC/DC 12-60 V yellow

Switching element

511 Snap-action switching contact 1 NC \ominus + 1 NO

Approvals



Mechanical values and environment

| | |
|--|--|
| Housing material | Anodized die-cast alloy |
| Weight | Net 0,3 kg |
| Ambient temperature | -25 ... 80 °C |
| Degree of protection | IP65 |
| Mechanical life | 30 x 10 ⁶ |
| Contact material | Silver alloy, gold flashed |
| Switching principle | Snap-action switching contact ^[1] |
| Installation position | Any |
| Number of door position positively driven contacts | 1 |
| Number of NO contacts | 1 |
| Connection | 1 x Plug connector SR6 ^[2] |
| Approach speed | max. 0,1 ... 10 m/min |
| Actuating element | Domed plunger |
| Actuating force | 15 ... 30 N |

Electrical connection ratings

| | |
|---|-----------------------------------|
| Rated thermal current I _{tH} | 6 A |
| Utilization category according to EN 60947-5-1 | AC-15 6A 230V DC-13 6A 24V |
| Short circuit protection according to IEC 60269-1 | (Fuse) 6A gG |
| Rated insulation voltage U _i | 250 V |
| Rated impulse withstand voltage U _{imp} | 2,5 kV |
| Switching current | Min. at DC 24V 10 mA |
| Display module | AC/DC 12 ... 60 V 60 V LED yellow |

Miscellaneous

| | | |
|----------|-------|-----|
| C number | C1630 | [3] |
|----------|-------|-----|

Reliability values acc. to EN ISO 13849-1

| | Monitoring of the safety guard position |
|------|---|
| B10D | 20×10^6 |

[1] Contact closing time <4 contact bounce time <3

[2] 6-pin + PE

[3] Special wiring

Dimension drawing

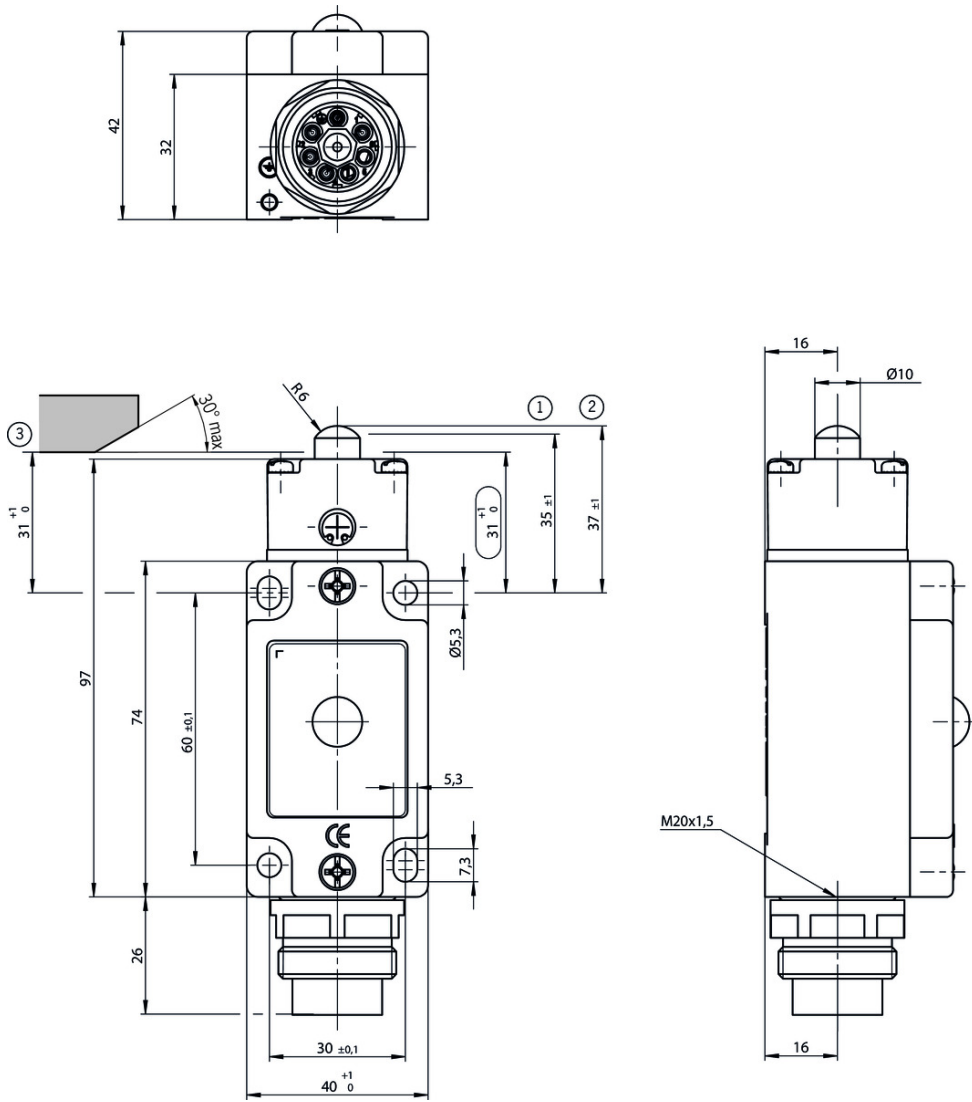

Legende

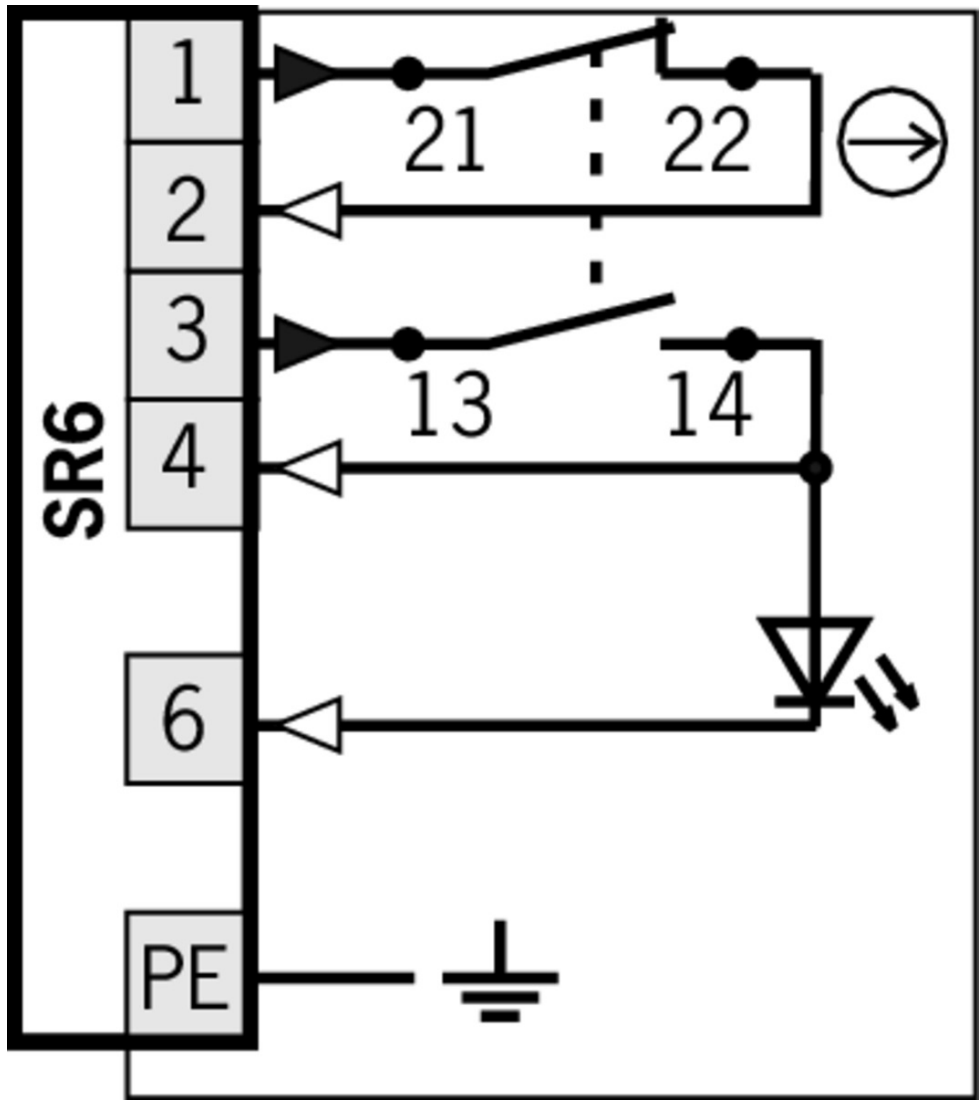

- 1 Operating point
- 2 Free position
- 3 End position

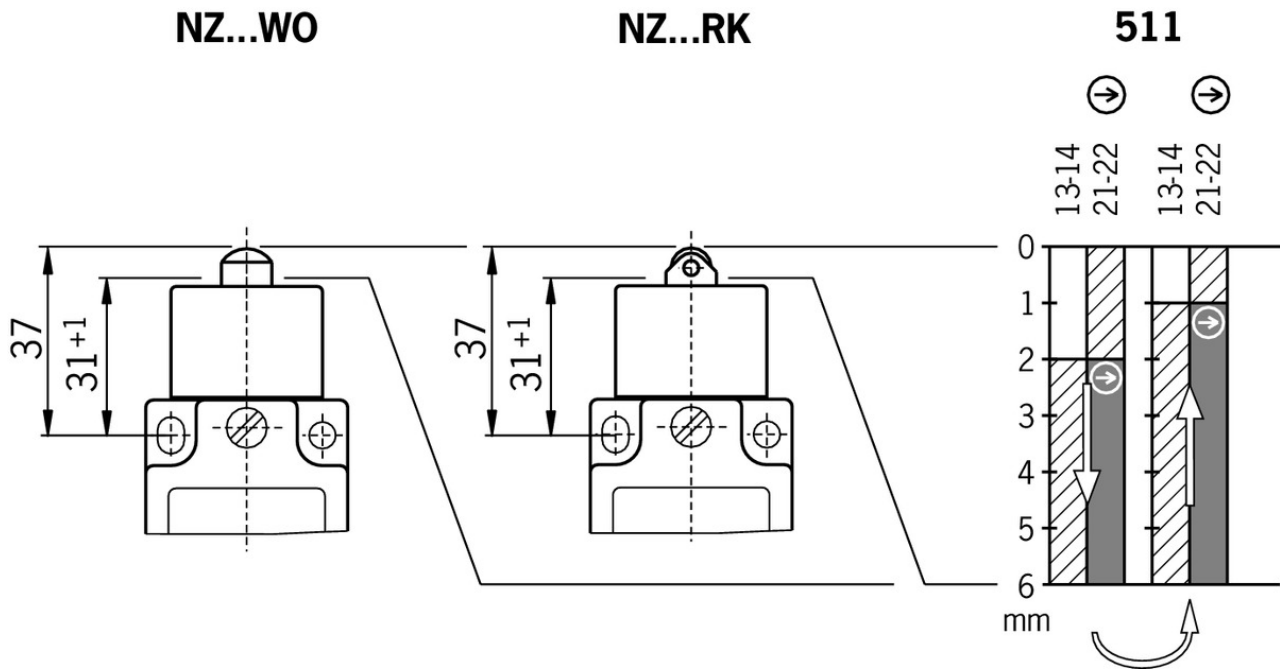

Travel diagram



Legende

-  Contacts closed
-  Contacts open
-  Contacts positively driven

Connection material

- ☑ Connection cable with plug connector SR6, 5m, angled



077638 C-R22F07-07X1,0PU05,0-MA-077638

☑ Features

- › Female plug SR6, 6-pin + PE
- › Angled plug connector
- › PUR cable
- › Cable length 5 m
- › With flying lead

- ☑ Plug connector SR6

013178 SR6K

☑ Features

- › Coding for plug connector SR6
- › Coding shells

087180 SR6AM2-M20

☑ Features

- › Crimp contacts
- › Male socket



024999 SR6WFPG11R

▼ Features

- › Socket crimp contacts
- › 6-pin+PE
- › Contact carrier can be adjusted in 7 outlet directions



013176 SR6EF

▼ Features

- › Crimp contacts
- › Coding shells

▼ Connection cable with plug connector SR6, 5m



077632 C-M26F07-07X1,0PU05,0-MA-077632

▼ Features

- › Female plug SR6, 6-pin + PE
- › Straight plug connector
- › PUR cable
- › Cable length 5 m
- › With flying lead

▼ Connection cable with plug connector SR6, 10m



077633 C-M26F07-07X1,0PU10,0-MA-077633

▼ Features

- › Female plug SR6, 6-pin + PE
- › Straight plug connector
- › PUR cable
- › Cable length 10 m
- › With flying lead

▼ Connection cable with plug connector SR6, 10m, angled



077639 C-R22F07-07X1,0PU10,0-MA-077639

▼ Features

- › Female plug SR6, 6-pin + PE
- › Angled plug connector
- › PUR cable
- › Cable length 10 m
- › With flying lead

▼ Connection cable with plug connector SR6, 15m



077634 C-M26F07-07X1,0PU15,0-MA-077634

▼ Features

- › Female plug SR6, 6-pin + PE
- › Straight plug connector
- › PUR cable

- › Cable length 15 m
- › With flying lead

☑ Connection cable with plug connector SR6, 15m, angled



077640 C-R22F07-07X1,0PU15,0-MA-077640

☑ Features

- › Female plug SR6, 6-pin + PE
- › Angled plug connector
- › PUR cable
- › Cable length 15 m
- › With flying lead

☑ Connection cable with plug connector SR6, 20m















098128 C-M26F07-07X1,0PU20,0-MA-098128

☑ Features

- › Female plug SR6, 6-pin + PE
- › Straight plug connector
- › PUR cable
- › Cable length 20 m
- › With flying lead

Instructions

☑ Betriebsanleitung Sicherheitsschalter NZ.D.../NZ.W.../NZ.R...

| | Doc. no. | Version | Language | Download |
|--|----------|----------|---|--|
| Betriebsanleitung Sicherheitsschalter NZ.D.../NZ.W.../NZ.R... | 074549 | 10-01/17 |  |  1.8 MB |
| Manual de instrucciones Interruptores de seguridad NZ.D.../NZ.W.../NZ.R... | | |  | |
| Mode d'emploi Interrupteur de sécurité NZ.D.../NZ.W.../NZ.R... | | |  | |
| Istruzioni di impiego Finecorsa di sicurezza NZ.D.../NZ.W.../NZ.R... | | |  | |
| Operating Instructions Safety Switch NZ.D.../NZ.W.../NZ.R... | | |  | |
| Instrukcja obsługi Wyłącznik bezpieczeństwa NZ.D.../NZ.W.../NZ.R... | 074549 | 10-01/17 |  |  0.4 MB |
| Инструкция по эксплуатации Предохранительный выключатель NZ.D.../NZ.W.../NZ.R... | 074549 | 10-01/17 |  |  0.6 MB |
| Návod na prevádzku Bezpečnostný spínač NZ.D.../NZ.W.../NZ.R... | 074549 | 10-01/17 |  |  0.4 MB |

Catalogs

☑ Sicherheitsschalter mit Metallgehäuse Safety Switches with Metal Housing Bezpečnostní spínače

s kovovým pouzdem Interrupteurs de sécurité avec boîtier métallique 金属壳体 的安全开关
 Interruptores de seguridad con carcasa metálica

| | Doc. no. | Version | Language | Download |
|---|----------|----------|----------|----------|
| Sicherheitsschalter mit Metallgehäuse | 100319 | 11-03/18 | | 7.9 MB |
| Interrupteurs de sécurité avec boîtier métallique | 100676 | 11-03/18 | | 7.9 MB |
| Interruptores de seguridad con carcasa metálica | 104856 | 11-03/18 | | 14.0 MB |
| Safety Switches with Metal Housing | 100369 | 11-03/18 | | 7.9 MB |
| Bezpečnostní spínače s kovovým pouzdem | 121650 | 11-03/18 | | 7.9 MB |
| 金属壳体 的安全开关 | 102453 | 11-03/18 | | 8.2 MB |

Declaration of conformity

EU prohlášení o shodě

| | Doc. no. | Version | Language | Download |
|---------------------------------|----------|----------|----------|----------|
| EU-Konformitätserklärung | 2077153 | 25-02/17 | | 0.3 MB |
| Declaración UE de conformidad | | | | |
| Déclaration UE de conformité | | | | |
| Dichiarazione di conformità | | | | |
| EU declaration of conformity | | | | |
| EU prohlášení o shodě | 2077153 | 25-02/17 | | 0.5 MB |
| EU-overensstemmelseserklæring | | | | |
| Δήλωση συμμόρφωσης της ΕΕ | | | | |
| EU-vaatimustenmukaisuusvakuutus | | | | |
| EU-típusbizonyítvány | | | | |
| EU-conformiteitsverklaring | | | | |
| Deklaracja zgodności UE | | | | |
| Declaração de Conformidade UE | | | | |
| Declarația de conformitate UE | | | | |
| EÚ vyhlásenie o zhode | | | | |

CAD data

CAD data for this item on TraceParts