

## ITEM 086408 NZ1RK-528L060GE-MC1912

Description	Technical data	Accessories	Downloads
-------------	----------------	-------------	-----------



### Features

- › Steel roller  $\varnothing$  8 mm
- › LED indicator
- › Cable entry M20 x 1.5
- › With ball bearings

### Approach direction

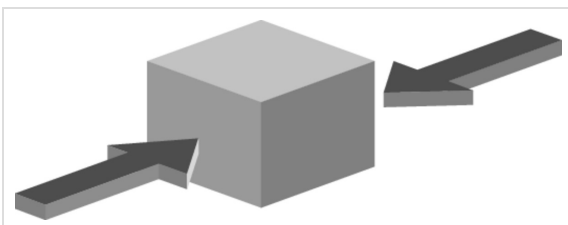

- › Figure  
Horizontal  
Can be adjusted in 90° steps

### LED function display

A function display is available for the following voltage range:

- › AC/DC 12-60 V yellow

## Switching element

**528H** Slow-action switching contact 1 NC $\ominus$  + 1 NO

## Approvals



## Mechanical values and environment

Housing material	Anodized die-cast alloy
Weight	Net 0,3 kg
Ambient temperature	-25 ... 80 °C
Degree of protection	IP67
Mechanical life	30 x 10 <sup>6</sup>
Contact material	Silver alloy, gold flashed
Switching principle	Slow-action switching contact
Installation position	Any
Number of door position positively driven contacts	1
Number of NO contacts	1
Connection	1 x M20 x 1.5
Approach speed	max. 0,1 ... 80 m/min
Actuating element	Ball bearing Roller plunger <sup>[1]</sup>
Actuating force	15 ... 30 N

## Electrical connection ratings

Rated thermal current I <sub>th</sub>	4 A
Utilization category according to EN 60947-5-1	AC-15 4A 230V DC-13 4A 24V
Short circuit protection according to IEC 60269-1	(Fuse) 4A gG
Rated insulation voltage U <sub>i</sub>	250 V
Rated impulse withstand voltage U <sub>imp</sub>	2,5 kV
Switching current	

	Min. at DC 24V	1 mA
Connection cross-section		0,34 ... 1,5 mm <sup>2</sup>
Display module	AC/DC	12 ... 60 V 60 V LED yellow

### Miscellaneous

C number	C1912	[2]
----------	-------	-----

### Reliability values acc. to EN ISO 13849-1

	Monitoring of the safety guard position
B10 <sub>D</sub>	20 x 10 <sup>6</sup>

---

[1] d roller = 8 mm

[2] Roller plunger with ball bearings + soft spring for high approach speeds and long travel distances

## Dimension drawing

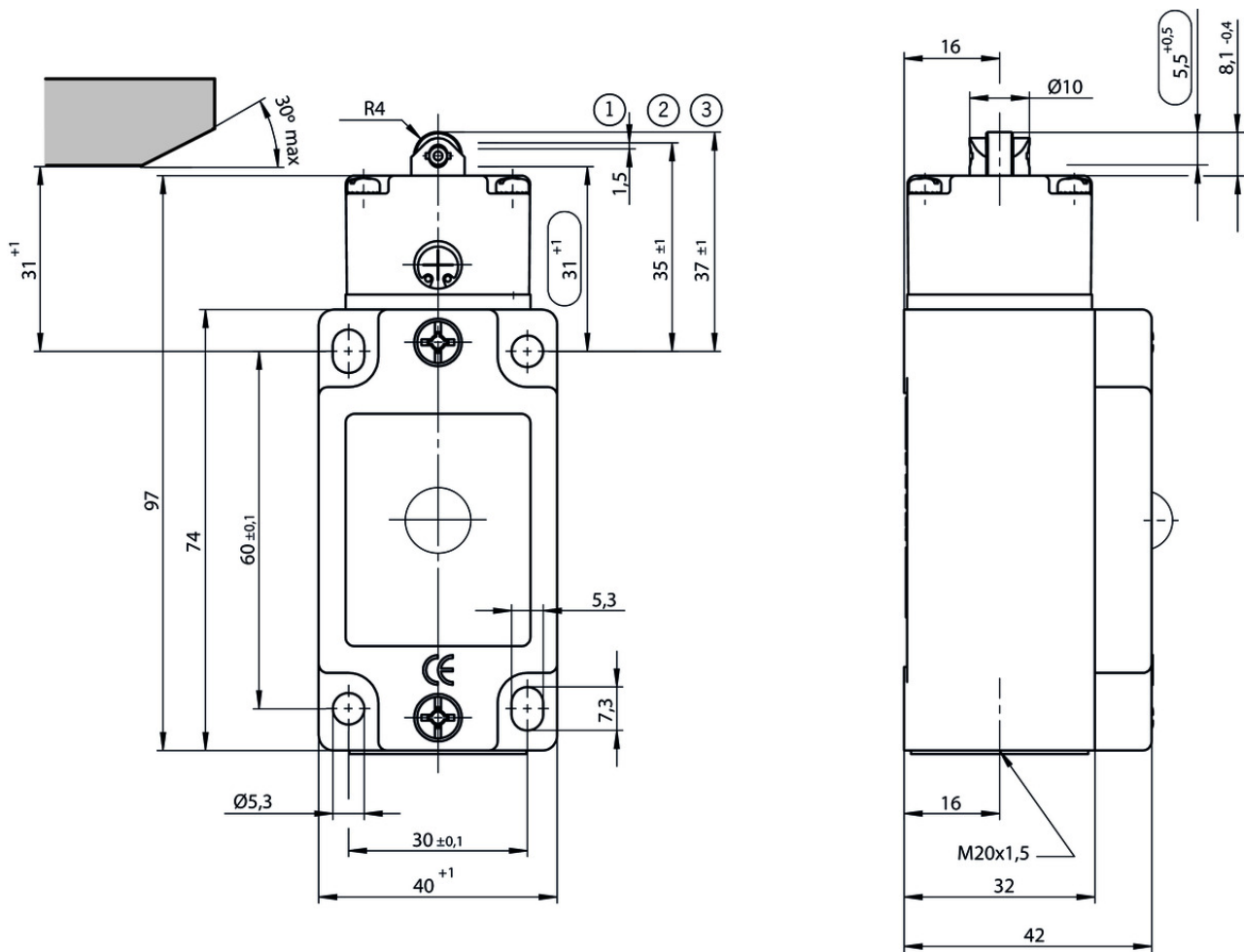

## Legende

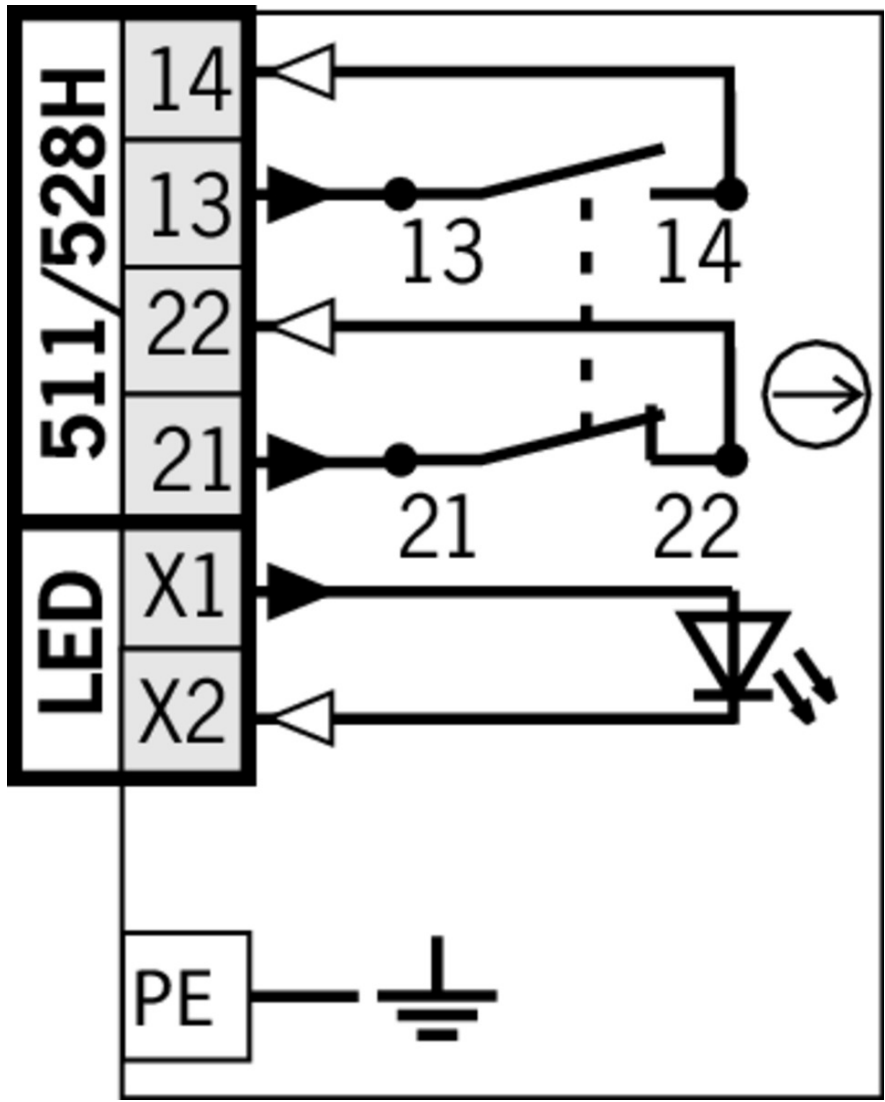

- 1 Operating point NO contact
- 2 Operating point NC contact
- 3 Free position

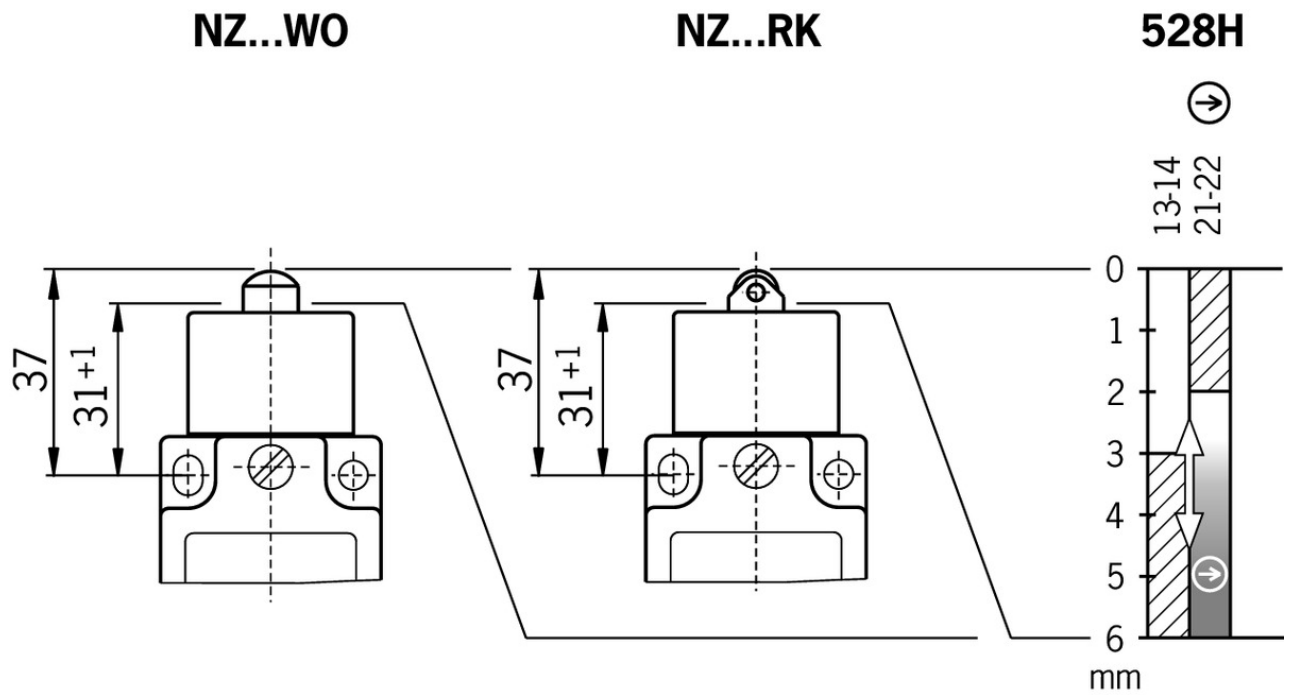

## Travel diagram



## Legende

-  Contacts closed
-  Contacts open
-  Contacts positively driven

## Connection material

- Cable glands M20x1.5



**077684** EKVM20/09



**077683** EKVM20/06

## Instructions











- Betriebsanleitung Sicherheitsschalter NZ.D.../NZ.W.../NZ.R...

Doc. no.    Version    Language    Download

Betriebsanleitung Sicherheitsschalter NZ.D.../NZ.W.../NZ.R... Manual de instrucciones Interruptores de seguridad NZ.D.../NZ.W.../NZ.R... Mode d'emploi Interrupteur de sécurité NZ.D.../NZ.W.../NZ.R... Istruzioni di impiego Finecorsa di sicurezza NZ.D.../NZ.W.../NZ.R... Operating Instructions Safety Switch NZ.D.../NZ.W.../NZ.R...	074549	10-01/17	    	 1.8 MB
Instrukcja obsługi Wyłącznik bezpieczeństwa NZ.D.../NZ.W.../NZ.R...	074549	10-01/17		 0.4 MB
Инструкция по эксплуатации Предохранительный выключатель NZ.D.../NZ.W.../NZ.R...	074549	10-01/17		 0.6 MB
Návod na prevádzku Bezpečnostný spínač NZ.D.../NZ.W.../NZ.R...	074549	10-01/17		 0.4 MB

## Catalogs

- ✓ Sicherheitsschalter mit Metallgehäuse Safety Switches with Metal Housing Bezpečnostní spínače s kovovým pouzdrém Interrupteurs de sécurité avec boîtier métallique 金属壳体 的安全开关 Interruptores de seguridad con carcasa metálica

	Doc. no.	Version	Language	Download
Sicherheitsschalter mit Metallgehäuse	100319	11-03/18		 7.9 MB
Interrupteurs de sécurité avec boîtier métallique	100676	11-03/18		 7.9 MB
Interruptores de seguridad con carcasa metálica	104856	11-03/18		 14.0 MB
Safety Switches with Metal Housing	100369	11-03/18		 7.9 MB
Bezpečnostní spínače s kovovým pouzdrém	121650	11-03/18		 7.9 MB
金属壳体 的安全开关	102453	11-03/18		 8.2 MB

## Declaration of conformity

- ✓ EU prohlášení o shodě

	Doc. no.	Version	Language	Download
EU-Konformitätserklärung Declaración UE de conformidad Déclaration UE de conformité Dichiarazione di conformità EU declaration of conformity	2077153	25-02/17	    	 0.3 MB
EU prohlášení o shodě EU-overensstemmelseserklæring Δήλωση συμμόρφωσης της ΕΕ EU-vaatimustenmukaisuusvakuutus EU-típusbizonyítvány EU-conformiteitsverklaring Deklaracja zgodności UE Declaração de Conformidade UE Declarația de conformitate UE EÚ vyhlásenie o zhode	2077153	25-02/17	         	 0.5 MB

## CAD data

