

**ITEM 086527 NZ1HB-528L060GE-M**

| Description | Technical data | Accessories | Downloads |
|-------------|----------------|-------------|-----------|
|-------------|----------------|-------------|-----------|



**Features**

- › Type A according to EN 50041(plastic roller  $\varnothing$  18 mm)
- › Cable entry M20 x 1.5
- › LED indicator

**Approach direction**

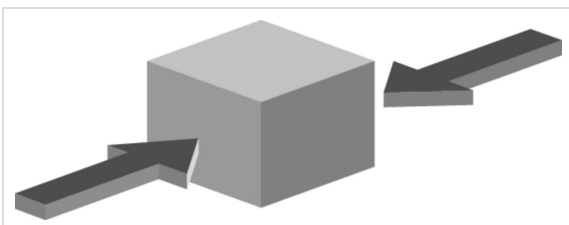

› Figure  
Horizontal

**Switching direction**

- › Right, left or both sides

**LED function display**

A function display is available for the following voltage range:

- › AC/DC 12-60 V yellow

## Switching element

**528H** Slow-action switching contact 1 NC $\text{\textcircled{R}}$  + 1 NO

## Approvals



## Mechanical values and environment

|  |  |
|--|--|
| Housing material                                   | Anodized die-cast alloy                    |
| Weight   |  |
|  | Net 0,3 kg                                 |
| Ambient temperature                                | -25 ... 80 °C                              |
| Degree of protection                               | IP67                                       |
| Mechanical life                                    | 30 x 10 <sup>6</sup>                       |
| Contact material                                   | Silver alloy, gold flashed                 |
| Switching principle                                | Slow-action switching contact              |
| Installation position                              | Any  |
| Number of door position positively driven contacts | 1  |
| Number of NO contacts                              | 1  |
| Connection   |  |
|  | 1 x M20 x 1.5                              |
| Approach speed                                     |  |
|  | max. 0,1 ... 300 m/min                     |
| Actuating element                                  |  |
|  | Plain bearing plastic Lever arm <b>[1]</b> |
| Actuating force                                    | min.15 N                                   |

## Electrical connection ratings

|   |               |
|---|---------------|
| Rated thermal current I <sub>th</sub>             | 4 A           |
| Utilization category according to EN 60947-5-1    |               |
|   | AC-15 4A 230V |
|   | DC-13 4A 24V  |
| Short circuit protection according to IEC 60269-1 |               |
|   | (Fuse) 4A gG  |
| Rated insulation voltage U <sub>i</sub>           | 250 V         |
| Rated impulse withstand voltage U <sub>imp</sub>  | 2,5 kV        |

|                          |                               |                             |
|--------------------------|-------------------------------|-----------------------------|
| Switching current        | Min. at DC 24V                | 1 mA                        |
| Connection cross-section | 0,34 ... 0,75 mm <sup>2</sup> |                             |
| Display module           | AC/DC                         | 12 ... 60 V 60 V LED yellow |

**Reliability values acc. to EN ISO 13849-1**

|                  |  |
|------------------|--|
|                  | <b>Monitoring of the safety guard position</b> |
| B10 <sub>D</sub> | 20 x 10 <sup>6</sup>                           |

[1] d roller = 18 mm, length 32 mm

**Dimension drawing**

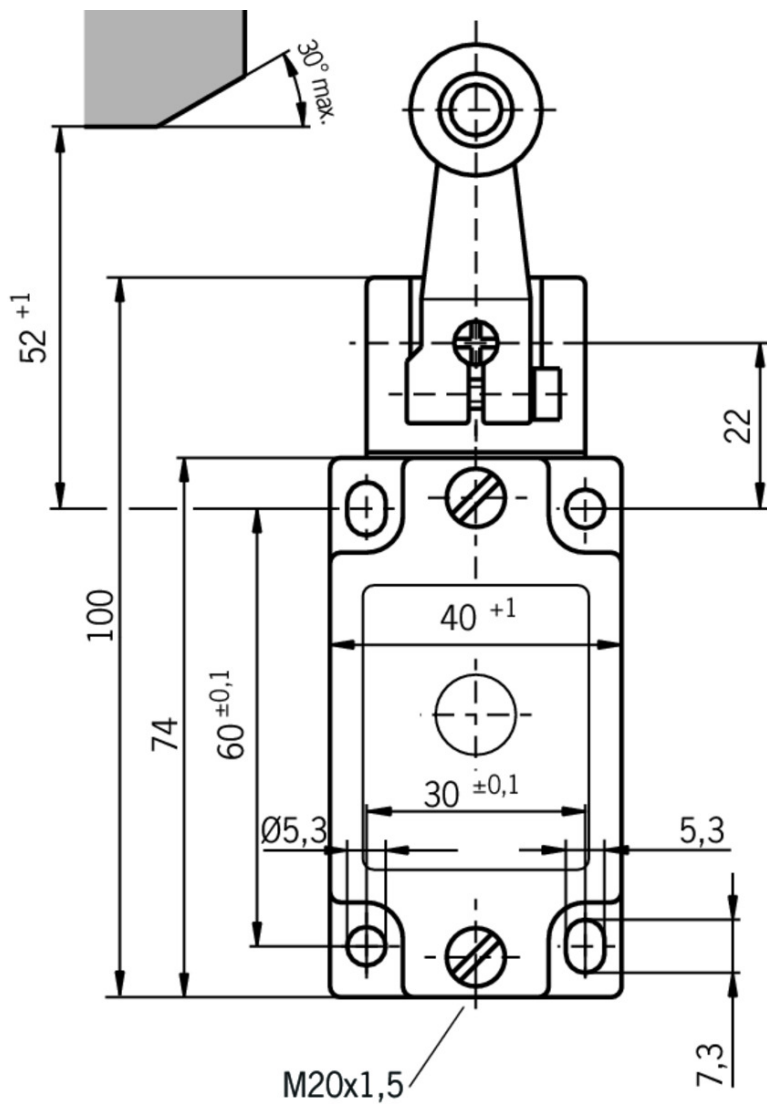

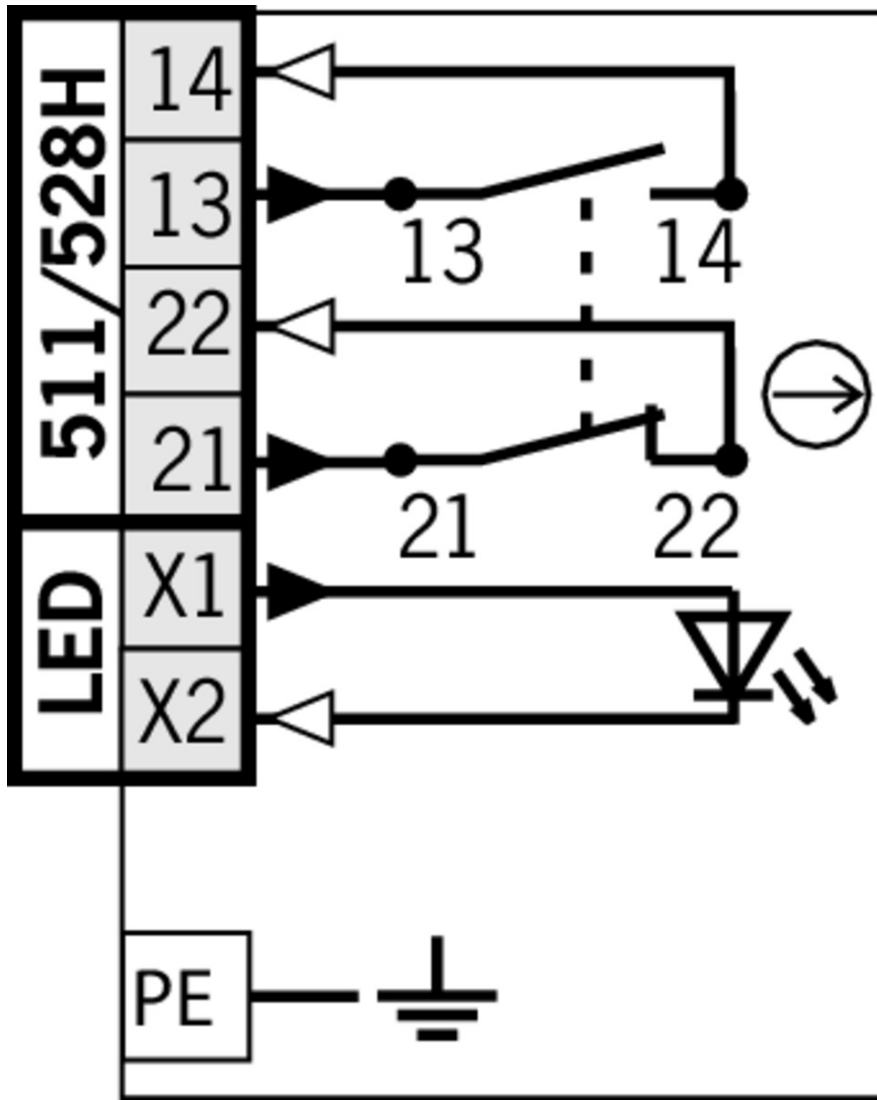

## Travel diagram

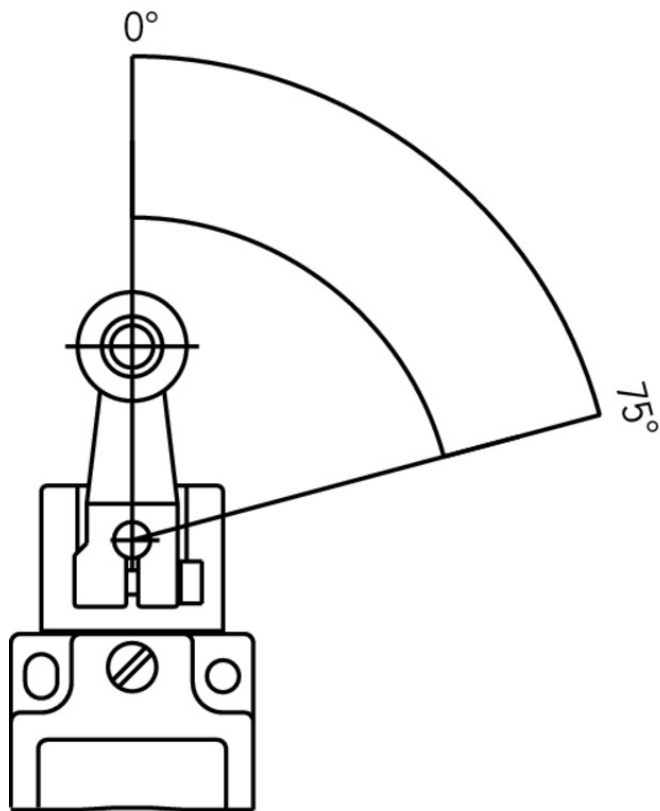

**NZ...HS**  
**NZ...HB**

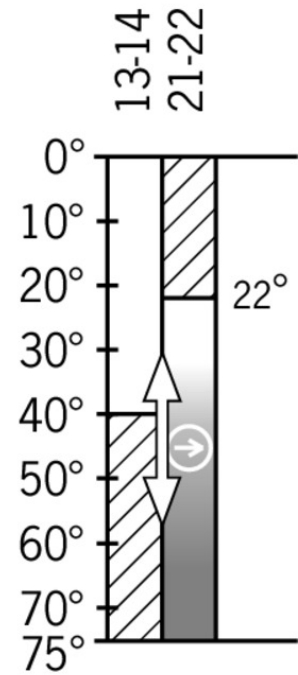

**528H**



## Legende

-  Contacts closed
-  Contacts open
-  Contacts positively driven

## Connection material

-  Cable glands M20x1.5



**077683** EKVM20/06



**077684** EKVM20/09

## Spare parts

## ▼ Lever arm with plastic roller



**012042** NHB ROLLENHEBEL

### ▼ Features

- › Plastic roller Ø18mm

## Instructions

### ▼ Betriebsanleitung Sicherheitsschalter NZ.H/P

|  | Doc. no. | Version  | Language         | Download |
|--|----------|----------|------------------|----------|
| Betriebsanleitung Sicherheitsschalter NZ.H/P<br>Manual de instrucciones Interruptores de seguridad NZ.H/P<br>Mode d'emploi Interrupteur de sécurité NZ.H/P<br>Istruzioni di impiego Finecorsa di sicurezza NZ.H/P<br>Operating Instructions Safety Switch NZ.H/P | 074550   | 11-12/16 | <br><br><br><br> | 2.1 MB   |
| Instrukcja obsługi Wyłącznik bezpieczeństwa NZ.H/P   | 074550   | 11-12/16 |                  | 0.5 MB   |
| Инструкция по эксплуатации<br>Предохранительный выключатель NZ.H/P   | 074550   | 11-12/16 |                  | 0.6 MB   |
| Návod na prevádzku Bezpečnostný spínač NZ.H/P  | 074550   | 11-12/16 |                  | 0.5 MB   |

## Catalogs









### ▼ Sicherheitsschalter mit Metallgehäuse Safety Switches with Metal Housing Bezpečnostní spínače s kovovým pouzdem Interrupteurs de sécurité avec boîtier métallique 金属壳体 的安全开关 Interruptores de seguridad con carcasa metálica

|   | Doc. no. | Version  | Language | Download |
|---|----------|----------|----------|----------|
| Sicherheitsschalter mit Metallgehäuse             | 100319   | 11-03/18 |          | 7.9 MB   |
| Interrupteurs de sécurité avec boîtier métallique | 100676   | 11-03/18 |          | 7.9 MB   |
| Interruptores de seguridad con carcasa metálica   | 104856   | 11-03/18 |          | 14.0 MB  |
| Safety Switches with Metal Housing                | 100369   | 11-03/18 |          | 7.9 MB   |
| Bezpečnostní spínače s kovovým pouzdem            | 121650   | 11-03/18 |          | 7.9 MB   |
| 金属壳体 的安全开关  | 102453   | 11-03/18 |          | 8.2 MB   |

## Declaration of conformity

### ▼ EU prohlášení o shodě

|  | Doc. no. | Version  | Language         | Download |
|--|----------|----------|------------------|----------|
| EU-Konformitätserklärung<br>Declaración UE de conformidad<br>Déclaration UE de conformité<br>Dichiarazione di conformità<br>EU declaration of conformity | 2077153  | 25-02/17 | <br><br><br><br> | 0.3 MB   |

|                                 |         |          |   |   |
|---------------------------------|---------|----------|---|---|
| EU prohlášení o shodě           | 2077153 | 25-02/17 |   |  0.5 MB |
| EU-overensstemmelseserklæring   |         |          |  |   |
| Δήλωση συμμόρφωσης της ΕΕ       |         |          |  |   |
| EU-vaatimustenmukaisuusvakuutus |         |          |  |   |
| EU-típusbizonyítvány            |         |          |  |   |
| EU-conformiteitsverklaring      |         |          |  |   |
| Deklaracja zgodności UE         |         |          |  |   |
| Declaração de Conformidade UE   |         |          |  |   |
| Declarația de conformitate UE   |         |          |  |   |
| EÚ vyhlásenie o zhode           |         |          |  |   |

### CAD data

CAD data for this item on TraceParts