

**ITEM 088196 NZ2HS-528L060**

Description	Technical data	Accessories	Downloads
-------------	----------------	-------------	-----------



**Features**

- › Version A according to EN 50041(steel roller  $\varnothing$  18 mm)
- › Plug connector SR6
- › LED indicator

**Approach direction**

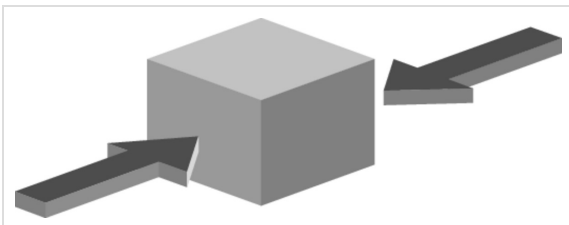

- › Figure  
Horizontal

**Switching direction**

- › Right, left or both sides

**LED function display**

A function display is available for the following voltage range:

- › AC/DC 12-60 V red

## Switching element

**528H** Slow-action switching contact 1 NC $\rightarrow$  + 1 NO

## Approvals



## Mechanical values and environment

Housing material	Anodized die-cast alloy
Weight	
	Net 0,3 kg
Ambient temperature	-25 ... 80 °C
Degree of protection	IP65
Mechanical life	30 x 10 <sup>6</sup>
Contact material	Silver alloy, gold flashed
Switching principle	Slow-action switching contact
Installation position	Any
Number of door position positively driven contacts	1
Number of NO contacts	1
Connection	
	1 x Plug connector SR6 [1]
Approach speed	
	max. 0,1 ... 60 m/min
Actuating element	
	Plain bearing metal Lever arm [2]
Actuating force	min.15 N

## Electrical connection ratings

Rated thermal current I <sub>th</sub>	4 A
Utilization category according to EN 60947-5-1	
	AC-15 4A 230V
	DC-13 4A 24V
Short circuit protection according to IEC 60269-1	
	(Fuse) 4A gG
Rated insulation voltage U <sub>i</sub>	250 V
Rated impulse withstand voltage U <sub>imp</sub>	2,5 kV

Switching current	Min. at DC 24V	1 mA
Display module	AC/DC	12 ... 60 V 60 V LED red

**Reliability values acc. to EN ISO 13849-1**

	Monitoring of the safety guard position
B10 <sub>D</sub>	20 x 10 <sup>6</sup>

---

[1] 6-pin + PE

[2] d roller = 18 mm, length = 32 mm

## Dimension drawing

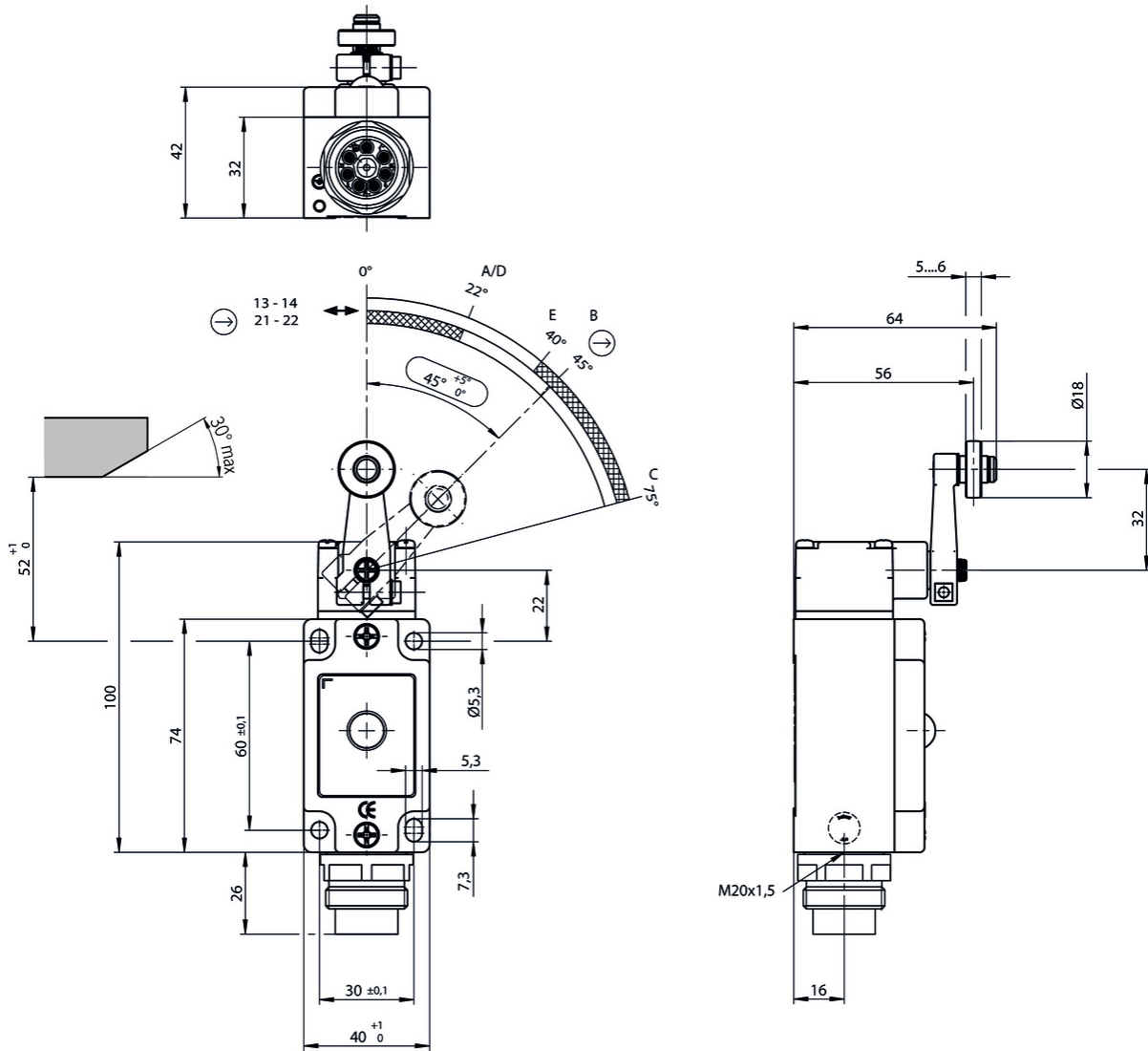

## Legende

- A = Operating point
- B = Positively driven travel
- C = End position
- D = Reset point
- R = Operating point (NO contact)

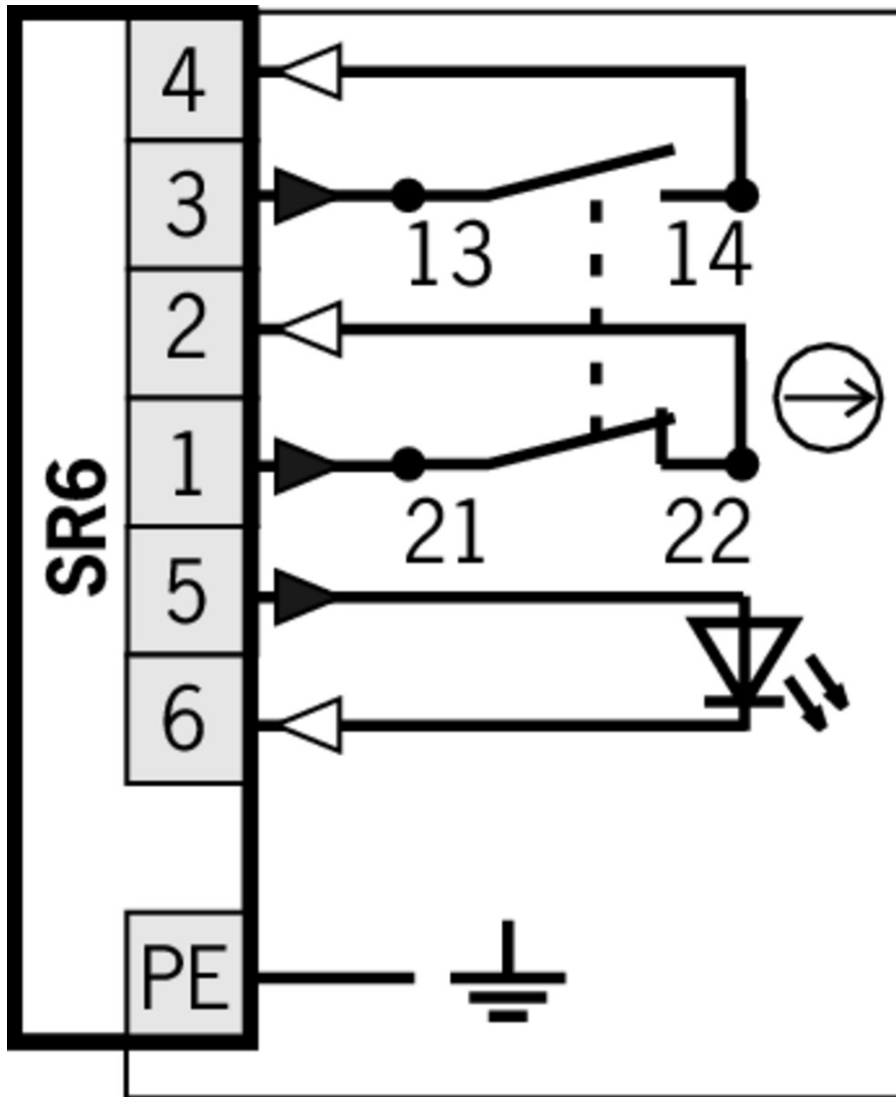

## Travel diagram

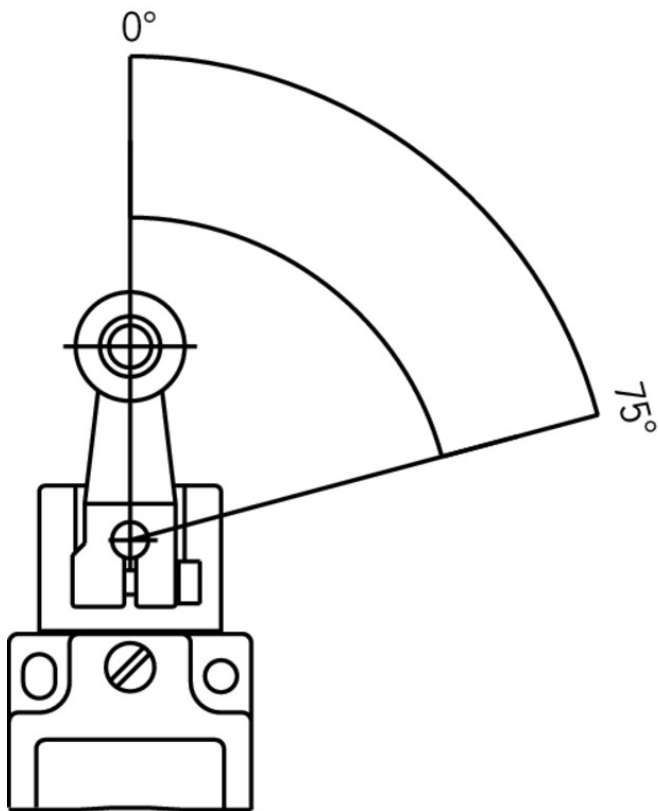

**NZ...HS**  
**NZ...HB**

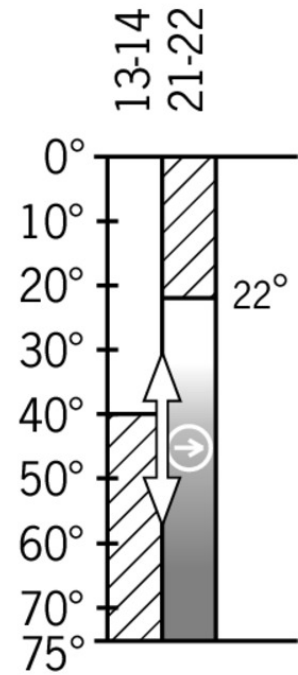

**528H**



## Legende

-  Contacts closed
-  Contacts open
-  Contacts positively driven

## Connection material

-  Plug connector SR6

**087180** SR6AM2-M20

-  Features
  - › Crimp contacts
  - › Male socket



**013176** SR6EF

-  Features
  - › Crimp contacts
  - › Coding shells



### **024999** SR6WFPG11R

#### ▼ Features

- › Socket crimp contacts
- › 6-pin+PE
- › Contact carrier can be adjusted in 7 outlet directions

### **013178** SR6K

#### ▼ Features

- › Coding for plug connector SR6
- › Coding shells

#### ▼ Connection cable with plug connector SR6, 5m



### **077632** C-M26F07-07X1,0PU05,0-MA-077632

#### ▼ Features

- › Female plug SR6, 6-pin + PE
- › Straight plug connector
- › PUR cable
- › Cable length 5 m
- › With flying lead

#### ▼ Connection cable with plug connector SR6, 5m, angled



### **077638** C-R22F07-07X1,0PU05,0-MA-077638

#### ▼ Features

- › Female plug SR6, 6-pin + PE
- › Angled plug connector
- › PUR cable
- › Cable length 5 m
- › With flying lead

#### ▼ Connection cable with plug connector SR6, 10m



### **077633** C-M26F07-07X1,0PU10,0-MA-077633

#### ▼ Features

- › Female plug SR6, 6-pin + PE
- › Straight plug connector
- › PUR cable
- › Cable length 10 m
- › With flying lead

#### ▼ Connection cable with plug connector SR6, 10m, angled



### **077639** C-R22F07-07X1,0PU10,0-MA-077639

#### ▼ Features

- › Female plug SR6, 6-pin + PE
- › Angled plug connector
- › PUR cable
- › Cable length 10 m
- › With flying lead

- 
- ▼ Connection cable with plug connector SR6, 15m



**077634** C-M26F07-07X1,0PU15,0-MA-077634

▼ Features

- › Female plug SR6, 6-pin + PE
- › Straight plug connector
- › PUR cable
- › Cable length 15 m
- › With flying lead

- 
- ▼ Connection cable with plug connector SR6, 15m, angled



**077640** C-R22F07-07X1,0PU15,0-MA-077640

▼ Features

- › Female plug SR6, 6-pin + PE
- › Angled plug connector
- › PUR cable
- › Cable length 15 m
- › With flying lead

- 
- ▼ Connection cable with plug connector SR6, 20m



**098128** C-M26F07-07X1,0PU20,0-MA-098128

▼ Features

- › Female plug SR6, 6-pin + PE
- › Straight plug connector
- › PUR cable
- › Cable length 20 m
- › With flying lead

---

## Function expansion

- ▼ LED function display NZ



**029220** NGL060RT

---

## Spare parts

- ▼ Lever arm with steel roller



**012043** NHS ROLLENHEBEL

▼ Features

- › Steel roller Ø18mm
-















## Instructions

### ▼ Betriebsanleitung Sicherheitsschalter NZ.H/P

	Doc. no.	Version	Language	Download
Betriebsanleitung Sicherheitsschalter NZ.H/P Manual de instrucciones Interruptores de seguridad NZ.H/P Mode d'emploi Interrupteur de sécurité NZ.H/P Istruzioni di impiego Finecorsa di sicurezza NZ.H/P Operating Instructions Safety Switch NZ.H/P	074550	11-12/16	    	 2.1 MB
Instrukcja obsługi Wyłącznik bezpieczeństwa NZ.H/P	074550	11-12/16		 0.5 MB
Инструкция по эксплуатации Предохранительный выключатель NZ.H/P	074550	11-12/16		 0.6 MB
Návod na prevádzku Bezpečnostný spínač NZ.H/P	074550	11-12/16		 0.5 MB

## Catalogs

### ▼ Sicherheitsschalter mit Metallgehäuse Safety Switches with Metal Housing Bezpečnostní spínače s kovovým pouzdem Interrupteurs de sécurité avec boîtier métallique 金属壳体 的安全开关 Interruptores de seguridad con carcasa metálica

	Doc. no.	Version	Language	Download
Sicherheitsschalter mit Metallgehäuse	100319	11-03/18		 7.9 MB
Interrupteurs de sécurité avec boîtier métallique	100676	11-03/18		 7.9 MB
Interruptores de seguridad con carcasa metálica	104856	11-03/18		 14.0 MB
Safety Switches with Metal Housing	100369	11-03/18		 7.9 MB
Bezpečnostní spínače s kovovým pouzdem	121650	11-03/18		 7.9 MB
金属壳体 的安全开关	102453	11-03/18		 8.2 MB

## Declaration of conformity

### ▼ EU prohlášení o shodě

	Doc. no.	Version	Language	Download
EU-Konformitätserklärung Declaración UE de conformidad Déclaration UE de conformité Dichiarazione di conformità EU declaration of conformity	2077153	25-02/17	    	 0.3 MB
EU prohlášení o shodě EU-overensstemmelseserklæring Δήλωση συμμόρφωσης της ΕΕ EU-vaatimustenmukaisuusvakuutus EU-típusbizonyítvány EU-conformiteitsverklaring Deklaracja zgodności UE Declaração de Conformidade UE Declarația de conformitate UE EÚ vyhlásenie o zhode	2077153	25-02/17	        	 0.5 MB

## CAD data

