

## ITEM 089014 NZ2WO-511SVM5

Description	Technical data	Accessories	Downloads
-------------	----------------	-------------	-----------



### Features

- › Version B according to EN 50041(hardened)
- › Plug connector SVM5

### Approach direction

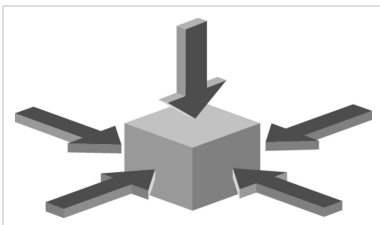

- › Figure  
Horizontal and vertical

### Switching element

**511** Snap-action switching contact 1 NC $\ominus$  + 1 NO

## Approvals



## Mechanical values and environment

Housing material	Anodized die-cast alloy
Weight	
Net	0,3 kg
Ambient temperature	-25 ... 80 °C
Degree of protection	IP67
Mechanical life	30 x 10 <sup>6</sup>
Contact material	Silver alloy, gold flashed
Switching principle	Snap-action switching contact <sup>[1]</sup>
Installation position	Any
Number of door position positively driven contacts	1
Number of NO contacts	1
Connection	
1 x	Plug connector M12 <sup>[2]</sup>
Approach speed	
max.	0,1 ... 10 m/min
Actuating element	Domed plunger
Actuating force	15 ... 30 N

## Electrical connection ratings

Rated thermal current I <sub>th</sub>	4 A
Utilization category according to EN 60947-5-1	
AC-15	4A 30V
DC-13	4A 24V
Short circuit protection according to IEC 60269-1	
(Fuse)	4A gG
Rated insulation voltage U <sub>i</sub>	50 V
Rated impulse withstand voltage U <sub>imp</sub>	1,5 kV
Switching current	
Min. at DC 24V	10 mA

## Reliability values acc. to EN ISO 13849-1

	<b>Monitoring of the safety guard position</b>
B10 <sub>D</sub>	20 x 10 <sup>6</sup>

[1] Contact closing time <4 contact bounce time <3

[2] 5-pin

### Dimension drawing

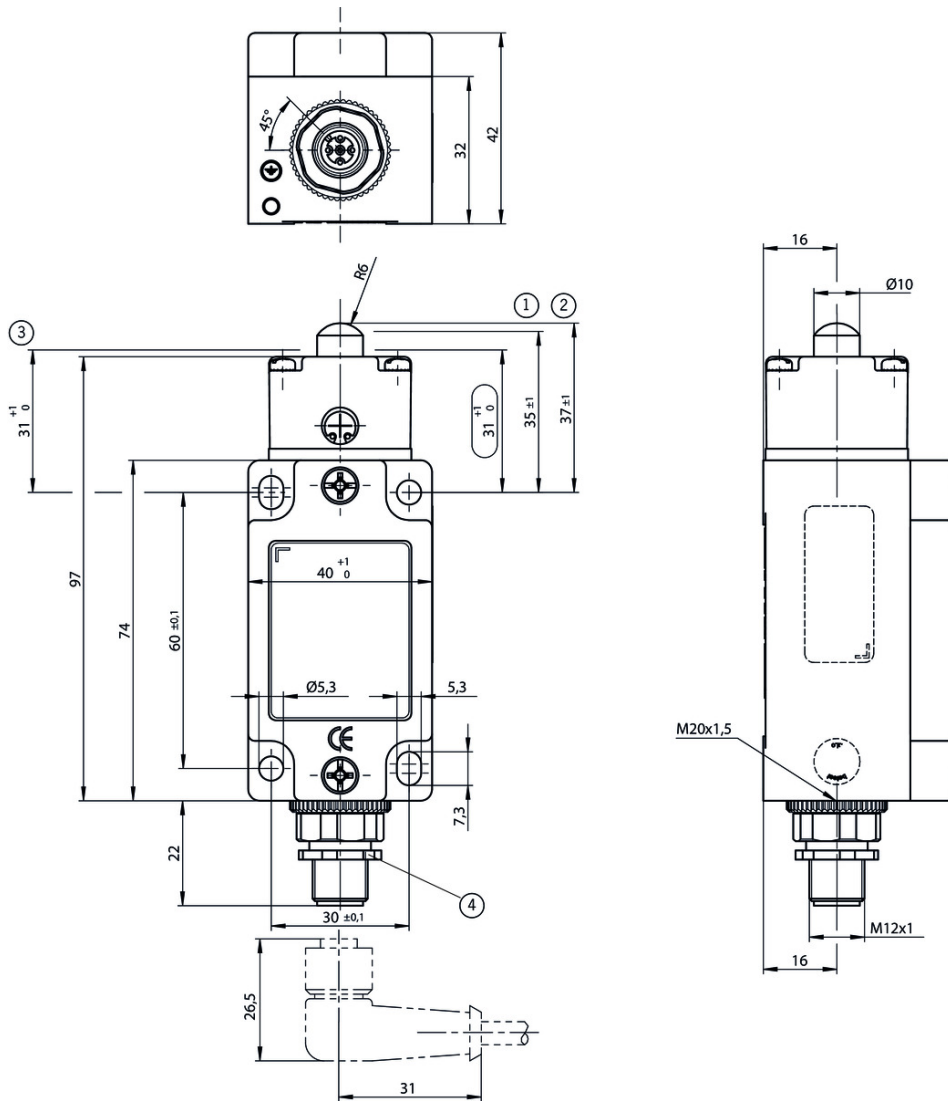

### Legende

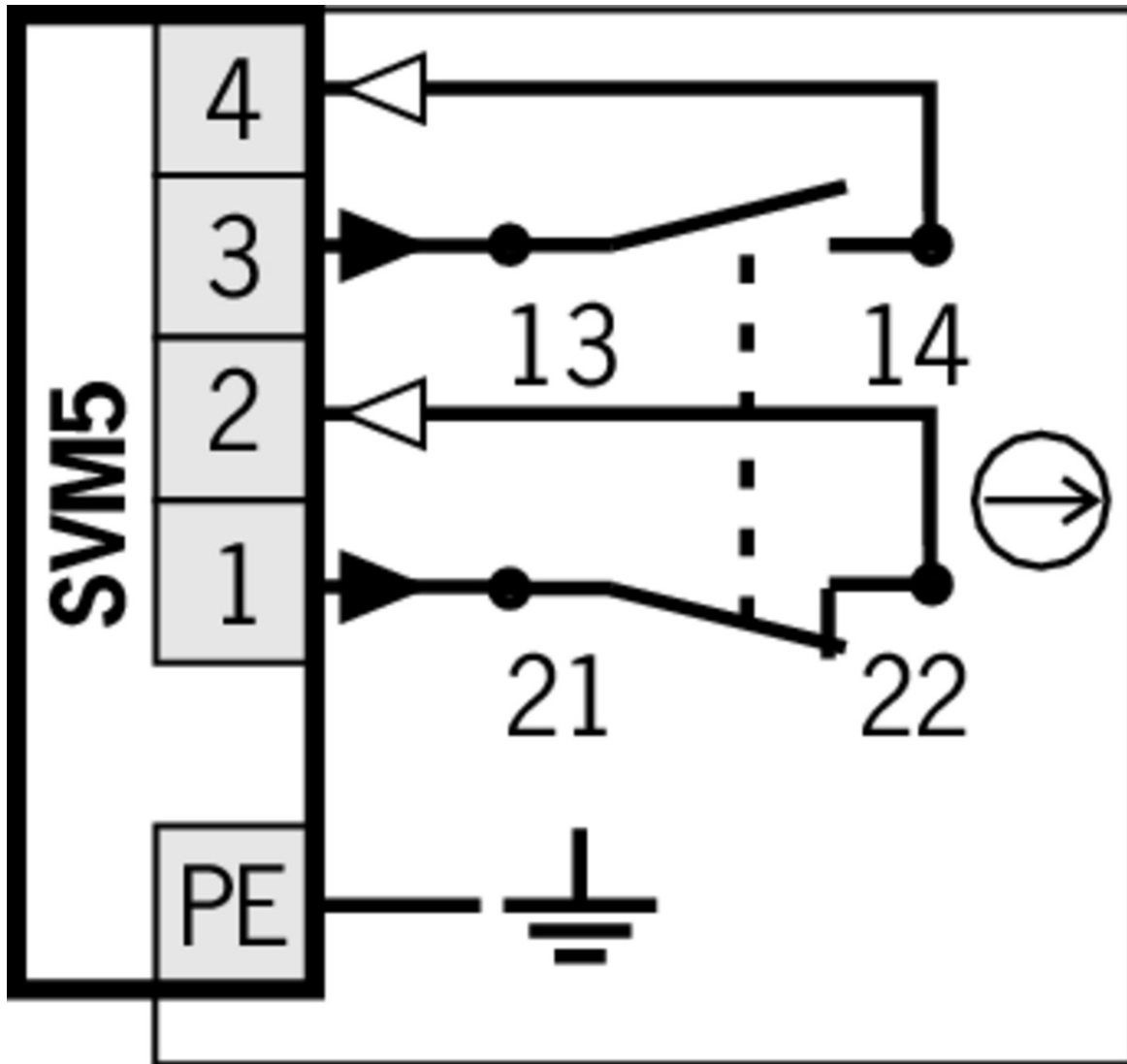

- 1 Operating point
- 2 Free position
- 3 End position
- 4 Male socket adjustable (max. 270°)

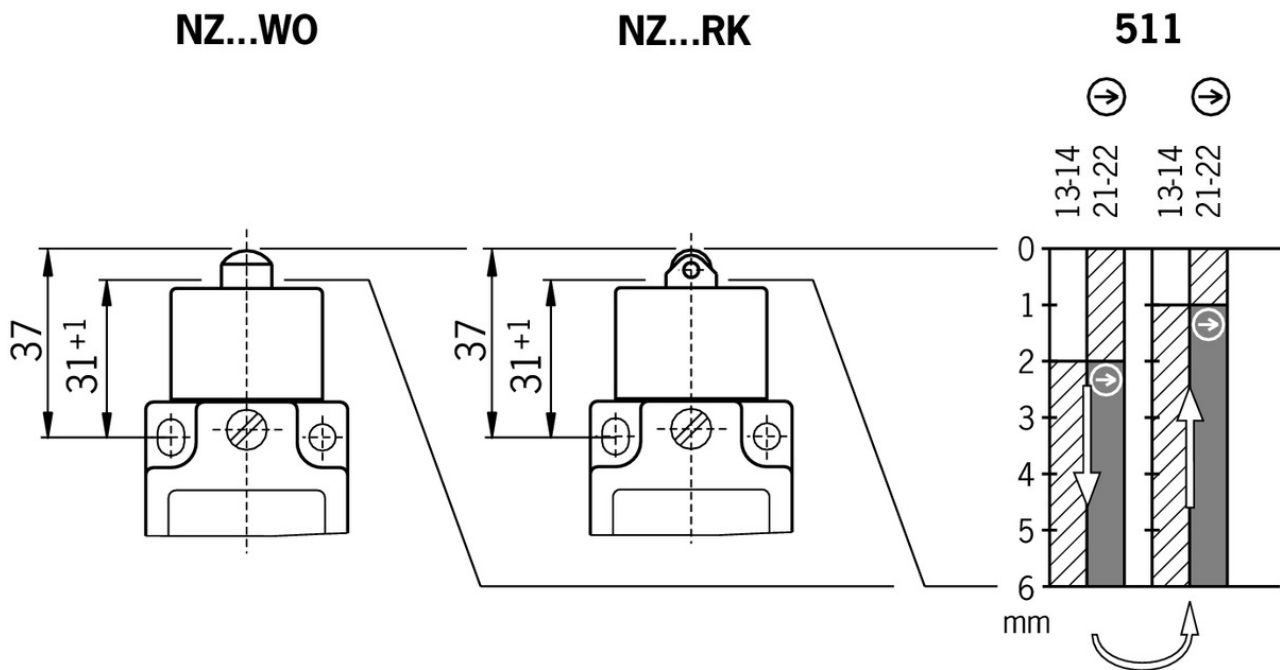

## Travel diagram



## Legende

-  Contacts closed
-  Contacts open
-  Contacts positively driven

## Connection material

- ☑ Connection cable with straight plug connector M12, 5-pin, 5m



**073461** C-M12F05-05X050PU05,0-GA-073461

### ☑ Features

- › M12 female plug, 4-pin + PE
- › Straight plug connector
- › PUR cable
- › Halogen-free
- › Cable length 5 m
- › With flying lead
- › Cores color-coded

- ☑ Connection cable with angled plug connector M12, 5-pin, 5m



**073462** C-M12F05-05X050PU05,0-GA-073462













### ☑ Features

- › M12 female plug, 4-pin + PE
- › Angled plug connector
- › PUR cable
- › Halogen-free

- › Cable length 5 m
- › With flying lead
- › Cores color-coded













## Instructions

### ▼ Betriebsanleitung Sicherheitsschalter NZ.D.../NZ.W.../NZ.R...

	Doc. no.	Version	Language	Download
Betriebsanleitung Sicherheitsschalter NZ.D.../NZ.W.../NZ.R... Manual de instrucciones Interruptores de seguridad NZ.D.../NZ.W.../NZ.R... Mode d'emploi Interrupteur de sécurité NZ.D.../NZ.W.../NZ.R... Istruzioni di impiego Finecorsa di sicurezza NZ.D.../NZ.W.../NZ.R... Operating Instructions Safety Switch NZ.D.../NZ.W.../NZ.R...	074549	10-01/17	    	 1.8 MB
Instrukcja obsługi Wyłącznik bezpieczeństwa NZ.D.../NZ.W.../NZ.R...	074549	10-01/17		 0.4 MB
Инструкция по эксплуатации Предохранительный выключатель NZ.D.../NZ.W.../NZ.R...	074549	10-01/17		 0.6 MB
Návod na prevádzku Bezpečnostný spínač NZ.D.../NZ.W.../NZ.R...	074549	10-01/17		 0.4 MB

## Catalogs

### ▼ Sicherheitsschalter mit Metallgehäuse Safety Switches with Metal Housing Bezpečnostní spínače s kovovým pouzdrém Interrupteurs de sécurité avec boîtier métallique 金属壳体 的安全开关 Interruptores de seguridad con carcasa metálica

	Doc. no.	Version	Language	Download
Sicherheitsschalter mit Metallgehäuse	100319	11-03/18		 7.9 MB
Interrupteurs de sécurité avec boîtier métallique	100676	11-03/18		 7.9 MB
Interruptores de seguridad con carcasa metálica	104856	11-03/18		 14.0 MB
Safety Switches with Metal Housing	100369	11-03/18		 7.9 MB
Bezpečnostní spínače s kovovým pouzdrém	121650	11-03/18		 7.9 MB
金属壳体 的安全开关	102453	11-03/18		 8.2 MB

## Declaration of conformity

### ▼ EU prohlášení o shodě

Doc. no.	Version	Language	Download
----------	---------	----------	----------

EU-Konformitätserklärung	2077153	25-02/17		 0.3 MB
Declaración UE de conformidad				
Déclaration UE de conformité				
Dichiarazione di conformità				
EU declaration of conformity				
EU prohlášení o shodě	2077153	25-02/17		 0.5 MB
EU-overensstemmelseserklæring				
Δήλωση συμμόρφωσης της ΕΕ				
EU-vaatimustenmukaisuusvakuutus				
EU-típusbizonyítvány				
EU-conformiteitsverklaring				
Deklaracja zgodności UE				
Declaração de Conformidade UE				
Declarația de conformitate UE				
EÚ vyhlásenie o zhode				

### CAD data

CAD data for this item on TraceParts