

ITEM 089092 NZ2HB-511L060

| Description | Technical data | Accessories | Downloads |
|-------------|----------------|-------------|-----------|
|-------------|----------------|-------------|-----------|



Features

- › Type A according to EN 50041(plastic roller ø 18 mm)
- › Plug connector SR6
- › LED indicator

Approach direction

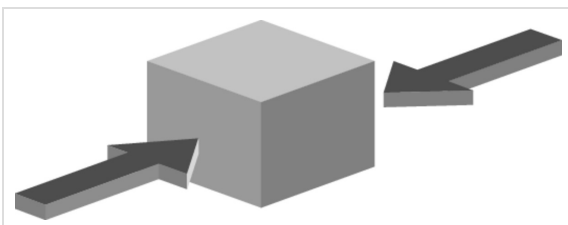

- › Figure
Horizontal

Switching direction

- › Right, left or both sides

LED function display

A function display is available for the following voltage range:

- › AC/DC 12-60 V red

Switching element

511 Snap-action switching contact 1 NC \rightarrow + 1 NO

Approvals



Mechanical values and environment

| | |
|--|--|
| Housing material | Anodized die-cast alloy |
| Weight | |
| Net | 0,3 kg |
| Ambient temperature | -25 ... 80 °C |
| Degree of protection | IP65 |
| Mechanical life | 30 x 10 ⁶ |
| Contact material | Silver alloy, gold flashed |
| Switching principle | Snap-action switching contact ^[1] |
| Installation position | Any |
| Number of door position positively driven contacts | 1 |
| Number of NO contacts | 1 |
| Connection | |
| 1 x | Plug connector SR6 ^[2] |
| Approach speed | |
| max. | 0,1 ... 300 m/min |
| Actuating element | |
| Plain bearing plastic | Lever arm ^[3] |
| Actuating force | min.15 N |

Electrical connection ratings

| | |
|---|---------|
| Rated thermal current I _{th} | 6 A |
| Utilization category according to EN 60947-5-1 | |
| AC-15 | 6A 230V |
| DC-13 | 6A 24V |
| Short circuit protection according to IEC 60269-1 | |
| (Fuse) | 6A gG |
| Rated insulation voltage U _i | 250 V |
| Rated impulse withstand voltage U _{imp} | 2,5 kV |

| | | |
|-------------------|----------------|--------------------------|
| Switching current | Min. at DC 24V | 10 mA |
| Display module | AC/DC | 12 ... 60 V 60 V LED red |

Reliability values acc. to EN ISO 13849-1

| | | |
|------------------|--|--|
| | Monitoring of the safety guard position | |
| B10 _D | 20 x 10 ⁶ | |

[1] Contact closing time <4 contact bounce time <3

[2] 6-pin + PE

[3] d roller = 18 mm, length = 32 mm

Dimension drawing

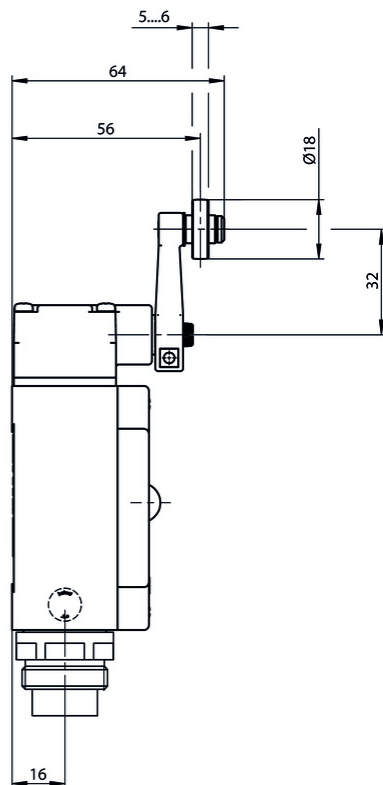
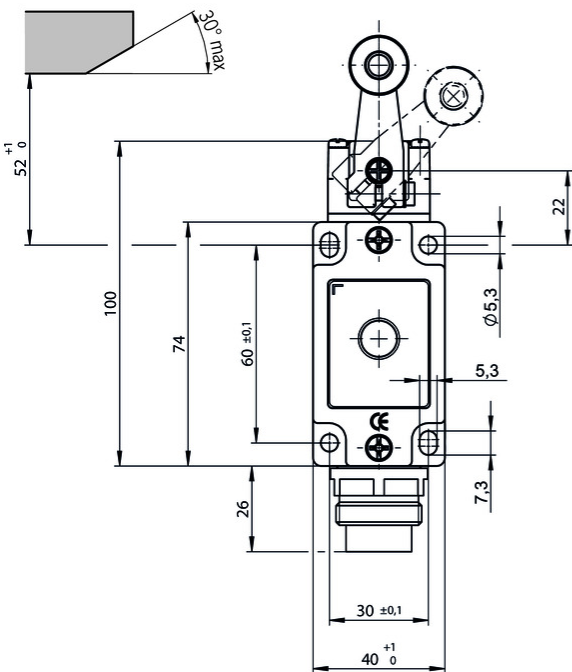
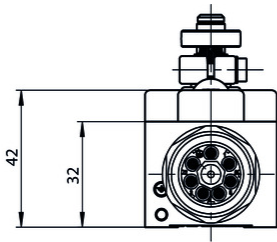

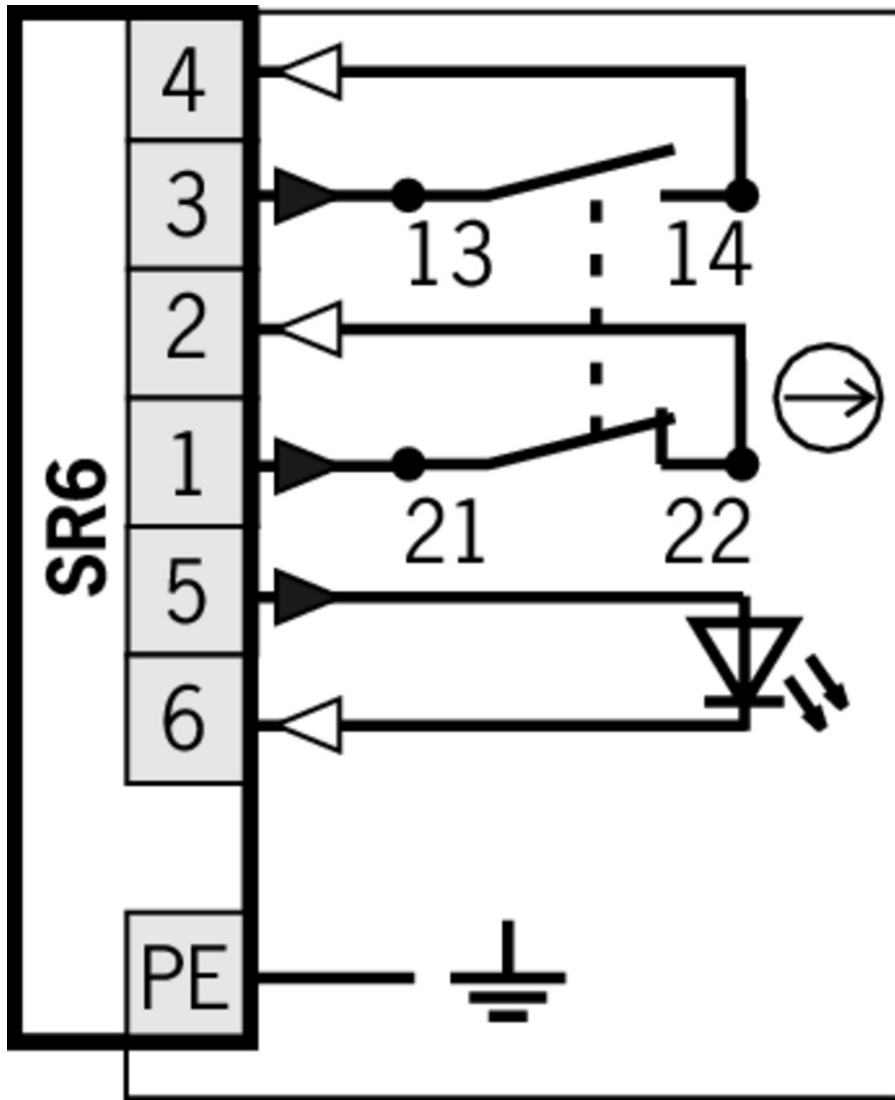

Travel diagram

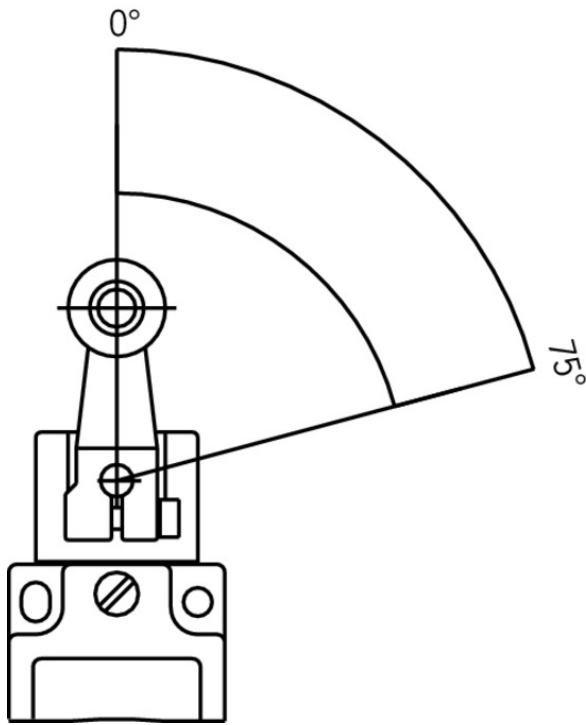

NZ...HS
NZ...HB

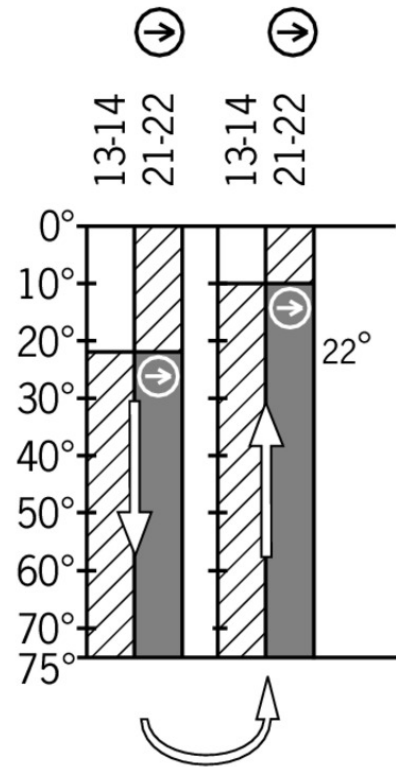

511



Legende

-  Contacts closed
-  Contacts open
-  Contacts positively driven

Function expansion

- LED function display NZ



029220 NGL060RT

Connection material

- Plug connector SR6



013176 SR6EF

- Features
 - › Crimp contacts
 - › Coding shells



024999 SR6WFPG11R

✓ Features

- › Socket crimp contacts
- › 6-pin+PE
- › Contact carrier can be adjusted in 7 outlet directions

013178 SR6K

✓ Features

- › Coding for plug connector SR6
- › Coding shells

087180 SR6AM2-M20

✓ Features

- › Crimp contacts
- › Male socket

✓ Connection cable with plug connector SR6, 5m



077632 C-M26F07-07X1,0PU05,0-MA-077632

✓ Features

- › Female plug SR6, 6-pin + PE
- › Straight plug connector
- › PUR cable
- › Cable length 5 m
- › With flying lead

✓ Connection cable with plug connector SR6, 5m, angled



077638 C-R22F07-07X1,0PU05,0-MA-077638

✓ Features

- › Female plug SR6, 6-pin + PE
- › Angled plug connector
- › PUR cable
- › Cable length 5 m
- › With flying lead

✓ Connection cable with plug connector SR6, 10m



077633 C-M26F07-07X1,0PU10,0-MA-077633

✓ Features

- › Female plug SR6, 6-pin + PE
- › Straight plug connector
- › PUR cable
- › Cable length 10 m
- › With flying lead

✓ Connection cable with plug connector SR6, 10m, angled

077639 C-R22F07-07X1,0PU10,0-MA-077639



- ▼ Features
 - › Female plug SR6, 6-pin + PE
 - › Angled plug connector
 - › PUR cable
 - › Cable length 10 m
 - › With flying lead
-

- ▼ Connection cable with plug connector SR6, 15m



077634 C-M26F07-07X1,0PU15,0-MA-077634

- ▼ Features
 - › Female plug SR6, 6-pin + PE
 - › Straight plug connector
 - › PUR cable
 - › Cable length 15 m
 - › With flying lead
-

- ▼ Connection cable with plug connector SR6, 15m, angled



077640 C-R22F07-07X1,0PU15,0-MA-077640

- ▼ Features
 - › Female plug SR6, 6-pin + PE
 - › Angled plug connector
 - › PUR cable
 - › Cable length 15 m
 - › With flying lead
-

- ▼ Connection cable with plug connector SR6, 20m



098128 C-M26F07-07X1,0PU20,0-MA-098128

- ▼ Features
 - › Female plug SR6, 6-pin + PE
 - › Straight plug connector
 - › PUR cable
 - › Cable length 20 m
 - › With flying lead
-

Spare parts

- ▼ Lever arm with plastic roller



012042 NHB ROLLENHEBEL

- ▼ Features
 - › Plastic roller Ø18mm
-













Instructions

▼ Betriebsanleitung Sicherheitsschalter NZ.H/P

| | Doc. no. | Version | Language | Download |
|--|----------|----------|---|--|
| Betriebsanleitung Sicherheitsschalter NZ.H/P Manual de instrucciones Interruptores de seguridad NZ.H/P Mode d'emploi Interrupteur de sécurité NZ.H/P Istruzioni di impiego Finecorsa di sicurezza NZ.H/P Operating Instructions Safety Switch NZ.H/P | 074550 | 11-12/16 |      |  2.1 MB |
| Instrukcja obsługi Wyłącznik bezpieczeństwa NZ.H/P | 074550 | 11-12/16 |  |  0.5 MB |
| Инструкция по эксплуатации Предохранительный выключатель NZ.H/P | 074550 | 11-12/16 |  |  0.6 MB |
| Návod na prevádzku Bezpečnostný spínač NZ.H/P | 074550 | 11-12/16 |  |  0.5 MB |

Catalogs

▼ Sicherheitsschalter mit Metallgehäuse Safety Switches with Metal Housing Bezpečnostní spínače s kovovým pouzdem Interrupteurs de sécurité avec boîtier métallique 金属壳体 的安全开关 Interruptores de seguridad con carcasa metálica

| | Doc. no. | Version | Language | Download |
|---|----------|----------|---|---|
| Sicherheitsschalter mit Metallgehäuse | 100319 | 11-03/18 |  |  7.9 MB |
| Interrupteurs de sécurité avec boîtier métallique | 100676 | 11-03/18 |  |  7.9 MB |
| Interruptores de seguridad con carcasa metálica | 104856 | 11-03/18 |  |  14.0 MB |
| Safety Switches with Metal Housing | 100369 | 11-03/18 |  |  7.9 MB |
| Bezpečnostní spínače s kovovým pouzdem | 121650 | 11-03/18 |  |  7.9 MB |
| 金属壳体 的安全开关 | 102453 | 11-03/18 |  |  8.2 MB |

Declaration of conformity

▼ EU prohlášení o shodě

| | Doc. no. | Version | Language | Download |
|--|----------|----------|---|--|
| EU-Konformitätserklärung Declaración UE de conformidad Déclaration UE de conformité Dichiarazione di conformità EU declaration of conformity | 2077153 | 25-02/17 |      |  0.3 MB |
| EU prohlášení o shodě EU-overensstemmelseserklæring Δήλωση συμμόρφωσης της ΕΕ EU-vaatimustenmukaisuusvakuutus EU-típusbizonyítvány EU-conformiteitsverklaring Deklaracja zgodności UE Declaração de Conformidade UE Declarația de conformitate UE EÚ vyhlásenie o zhode | 2077153 | 25-02/17 |          |  0.5 MB |

CAD data

