

ITEM 090027 NZ2RS-511SVM5

Description	Technical data	Accessories	Downloads
-------------	----------------	-------------	-----------



Features

- › Version C according to EN 50041(steel roller \varnothing 12 mm)
- › Plug connector SVM5

Approach direction



- › Figure
Horizontal
Can be adjusted in 90° steps

Switching element

511 Snap-action switching contact 1 NC \ominus + 1 NO

Approvals



Mechanical values and environment

Housing material	Anodized die-cast alloy
Weight	Net 0,3 kg
Ambient temperature	-25 ... 80 °C
Degree of protection	IP67
Mechanical life	30×10^6
Contact material	Silver alloy, gold flashed
Switching principle	Snap-action switching contact ^[1]
Installation position	Any
Number of door position positively driven contacts	1
Number of NO contacts	1
Connection	1 x Plug connector M12 ^[2]
Approach speed	max. 0,1 ... 20 m/min
Actuating element Plain bearing metal	Roller plunger ^[3]
Actuating force	15 ... 30 N

Electrical connection ratings

Rated thermal current I_{th}	4 A
Utilization category according to EN 60947-5-1	AC-15 4A 30V DC-13 4A 24V
Short circuit protection according to IEC 60269-1	(Fuse) 4A gG
Rated insulation voltage U_i	50 V
Rated impulse withstand voltage U_{imp}	1,5 kV
Switching current	Min. at DC 24V 10 mA

Reliability values acc. to EN ISO 13849-1

	Monitoring of the safety guard position
B10 _D	20×10^6

[1] Contact closing time <4 contact bounce time <3

[2] 5-pin

[3] Steel roller d roller = 12 mm

Dimension drawing

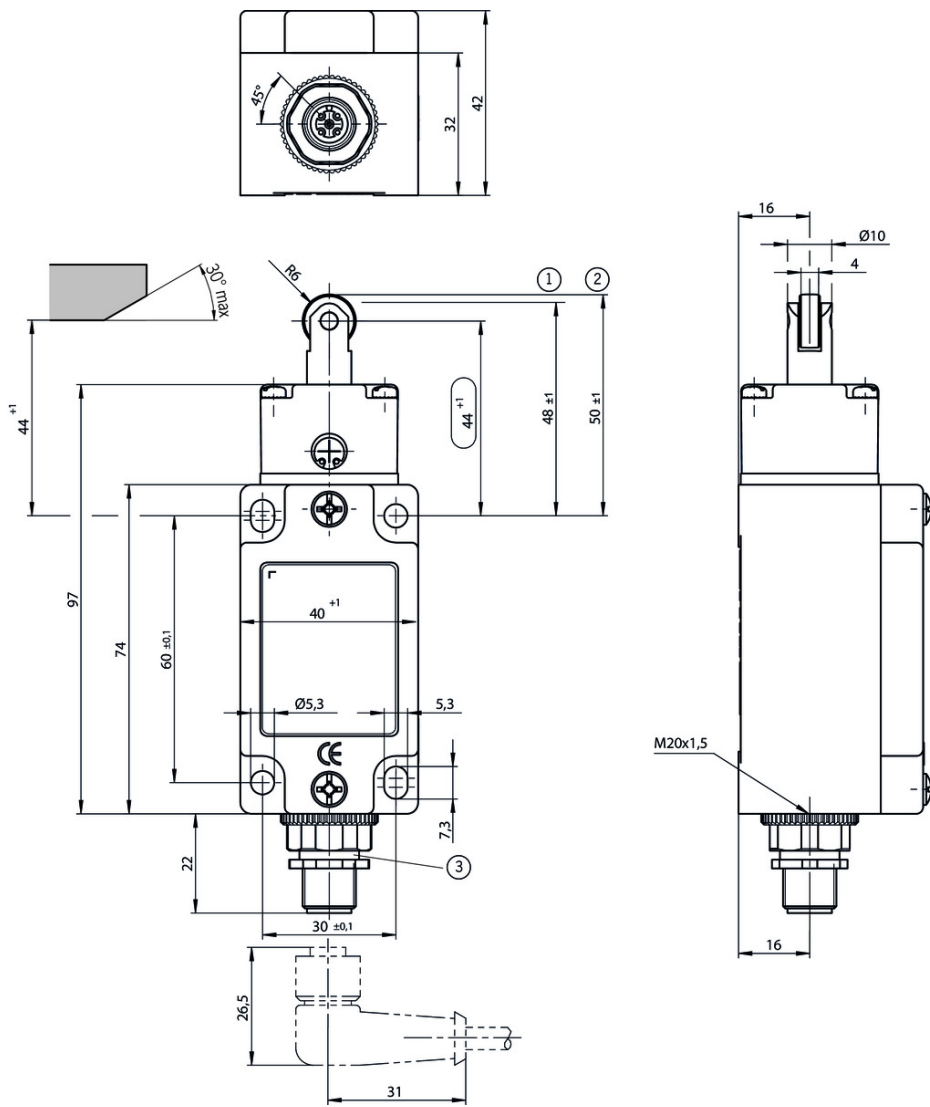

Legende

1 Operating point

2 Free position

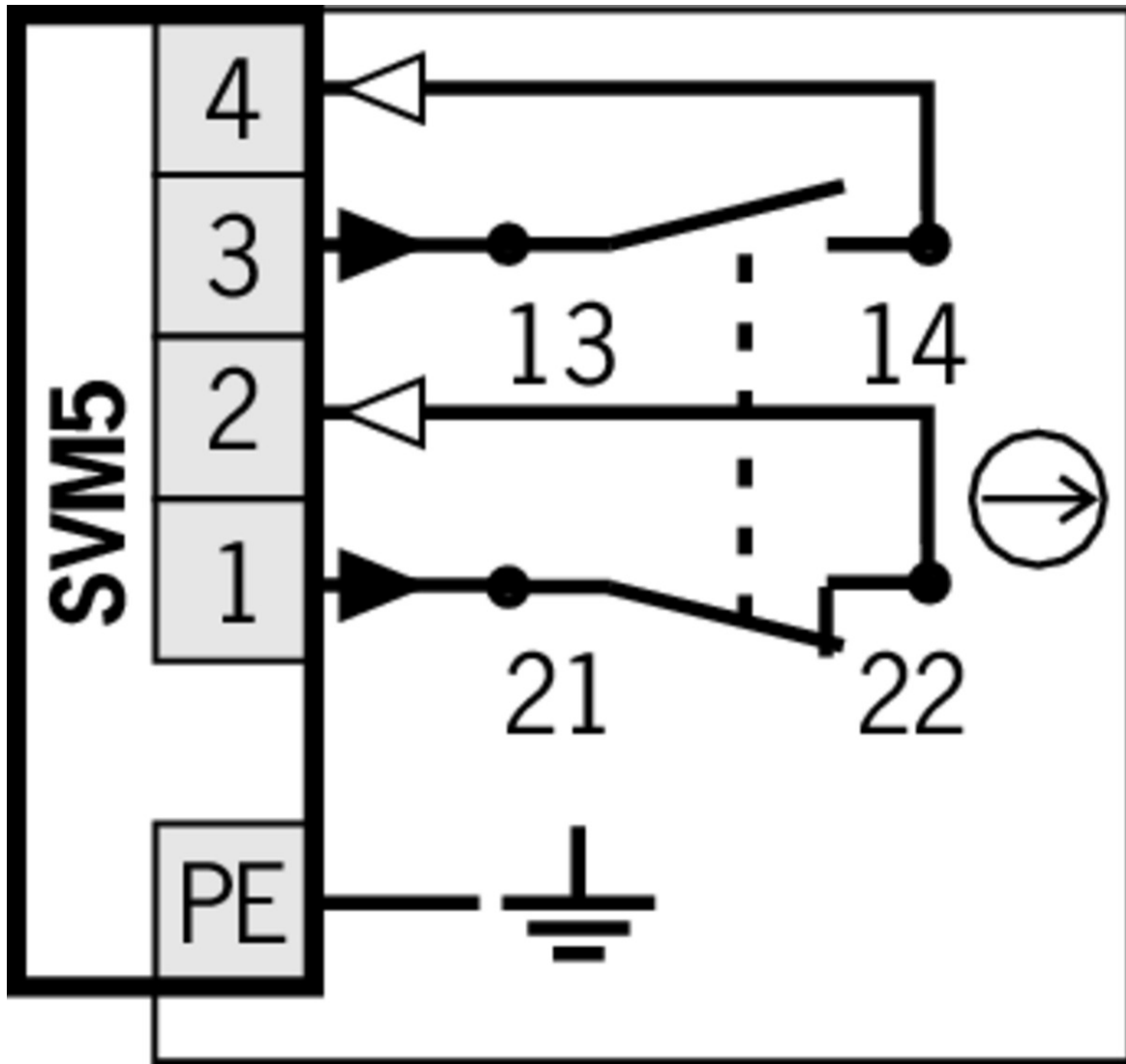

3 Male socket adjustable (max. 270°)

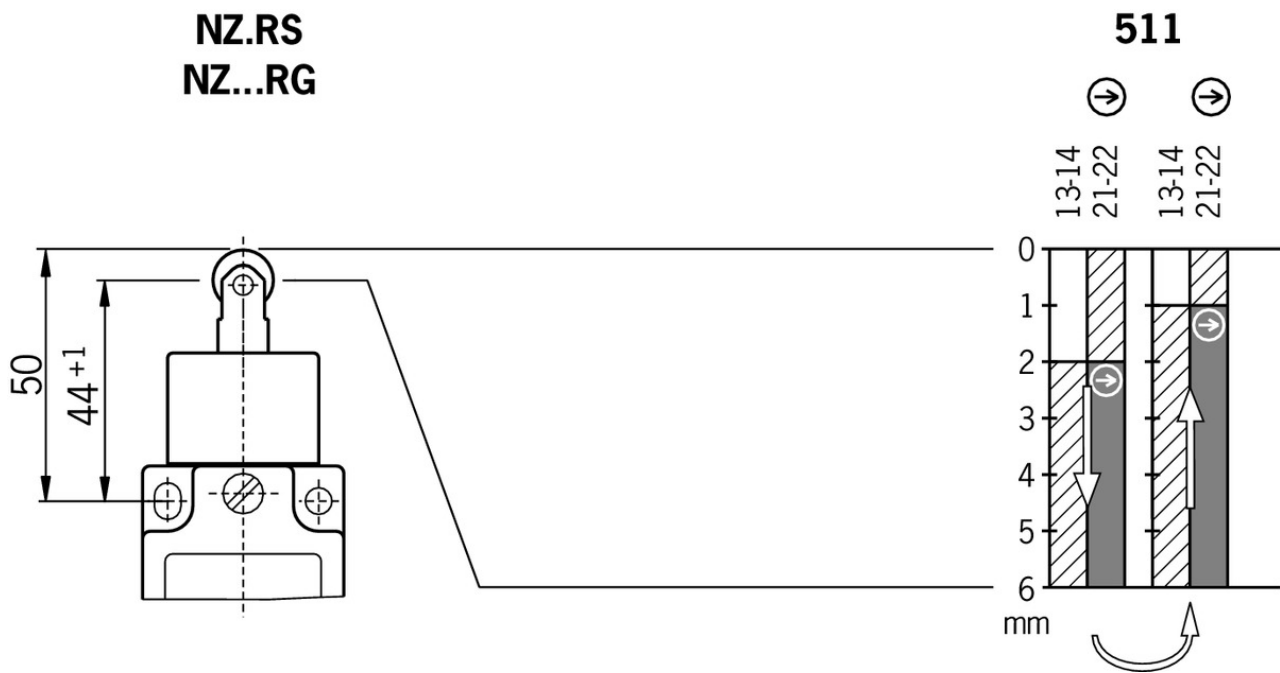

Travel diagram



Legende

-  Contacts closed
-  Contacts open
-  Contacts positively driven

Connection material

- ✓ Connection cable with angled plug connector M12, 5-pin, 5m



073462 C-M12F05-05X050PU05,0-GA-073462

✓ Features

- › M12 female plug, 4-pin + PE
- › Angled plug connector
- › PUR cable
- › Halogen-free
- › Cable length 5 m
- › With flying lead
- › Cores color-coded

- ✓ Connection cable with straight plug connector M12, 5-pin, 5m



073461 C-M12F05-05X050PU05,0-GA-073461







✓ Features

- › M12 female plug, 4-pin + PE
- › Straight plug connector
- › PUR cable
- › Halogen-free

- › Cable length 5 m
- › With flying lead
- › Cores color-coded













Instructions

▼ Betriebsanleitung Sicherheitsschalter NZ.D.../NZ.W.../NZ.R...

	Doc. no.	Version	Language	Download
Betriebsanleitung Sicherheitsschalter NZ.D.../NZ.W.../NZ.R... Manual de instrucciones Interruptores de seguridad NZ.D.../NZ.W.../NZ.R... Mode d'emploi Interrupteur de sécurité NZ.D.../NZ.W.../NZ.R... Istruzioni di impiego Finecorsa di sicurezza NZ.D.../NZ.W.../NZ.R... Operating Instructions Safety Switch NZ.D.../NZ.W.../NZ.R...	074549	10-01/17	    	 1.8 MB
Instrukcja obsługi Wyłącznik bezpieczeństwa NZ.D.../NZ.W.../NZ.R...	074549	10-01/17		 0.4 MB
Инструкция по эксплуатации Предохранительный выключатель NZ.D.../NZ.W.../NZ.R...	074549	10-01/17		 0.6 MB
Návod na prevádzku Bezpečnostný spínač NZ.D.../NZ.W.../NZ.R...	074549	10-01/17		 0.4 MB

Catalogs

▼ Sicherheitsschalter mit Metallgehäuse Safety Switches with Metal Housing Bezpečnostní spínače s kovovým pouzdem Interrupteurs de sécurité avec boîtier métallique 金属壳体 的安全开关 Interruptores de seguridad con carcasa metálica

	Doc. no.	Version	Language	Download
Sicherheitsschalter mit Metallgehäuse	100319	11-03/18		 7.9 MB
Interrupteurs de sécurité avec boîtier métallique	100676	11-03/18		 7.9 MB
Interruptores de seguridad con carcasa metálica	104856	11-03/18		 14.0 MB
Safety Switches with Metal Housing	100369	11-03/18		 7.9 MB
Bezpečnostní spínače s kovovým pouzdem	121650	11-03/18		 7.9 MB
金属壳体 的安全开关	102453	11-03/18		 8.2 MB

Declaration of conformity

▼ EU prohlášení o shodě

Doc. no.	Version	Language	Download
----------	---------	----------	----------

EU-Konformitätserklärung	2077153	25-02/17		 0.3 MB
Declaración UE de conformidad				
Déclaration UE de conformité				
Dichiarazione di conformità				
EU declaration of conformity				
EU prohlášení o shodě	2077153	25-02/17		 0.5 MB
EU-overensstemmelseserklæring				
Δήλωση συμμόρφωσης της ΕΕ				
EU-vaatimustenmukaisuusvakuutus				
EU-típusbizonyítvány				
EU-conformiteitsverklaring				
Deklaracja zgodności UE				
Declaração de Conformidade UE				
Declarația de conformitate UE				
EÚ vyhlásenie o zhode				

CAD data

CAD data for this item on TraceParts