

ITEM 090358 NZ1RK-528L060-M

Description	Technical data	Accessories	Downloads
-------------	----------------	-------------	-----------



Features

- › Steel roller \varnothing 8 mm
- › Cable entry M20 x 1.5
- › LED indicator

Approach direction

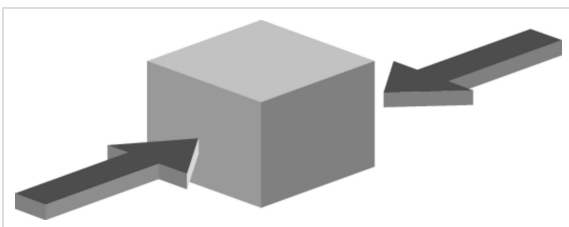

- › Figure
Horizontal
Can be adjusted in 90° steps

LED function display

- A function display is available for the following voltage range:
- › AC/DC 12-60 V red

Switching element

528H Slow-action switching contact 1 NC \ominus + 1 NO

Approvals



Mechanical values and environment

Housing material	Anodized die-cast alloy
Weight	
Net	0,3 kg
Ambient temperature	-25 ... 80 °C
Degree of protection	IP67
Mechanical life	30 x 10 ⁶
Contact material	Silver alloy, gold flashed
Switching principle	Slow-action switching contact
Installation position	Any
Number of door position positively driven contacts	1
Number of NO contacts	1
Connection	
1 x	M20 x 1.5
Approach speed	
max.	0,1 ... 50 m/min
Actuating element	
Plain bearing metal	Roller plunger ^[1]
Actuating force	15 ... 30 N

Electrical connection ratings

Rated thermal current I _{th}	4 A
Utilization category according to EN 60947-5-1	
AC-15	4A 230V
DC-13	4A 24V
Short circuit protection according to IEC 60269-1	
(Fuse)	4A gG
Rated insulation voltage U _i	250 V
Rated impulse withstand voltage U _{imp}	2,5 kV
Switching current	
Min. at DC 24V	1 mA
Connection cross-section	0,34 ... 0,75 mm ²

Display module

AC/DC 12 ... 60 V 60 V LED red

Reliability values acc. to EN ISO 13849-1

	Monitoring of the safety guard position
B10D	20×10^6

[1] d roller = 8 mm

Dimension drawing

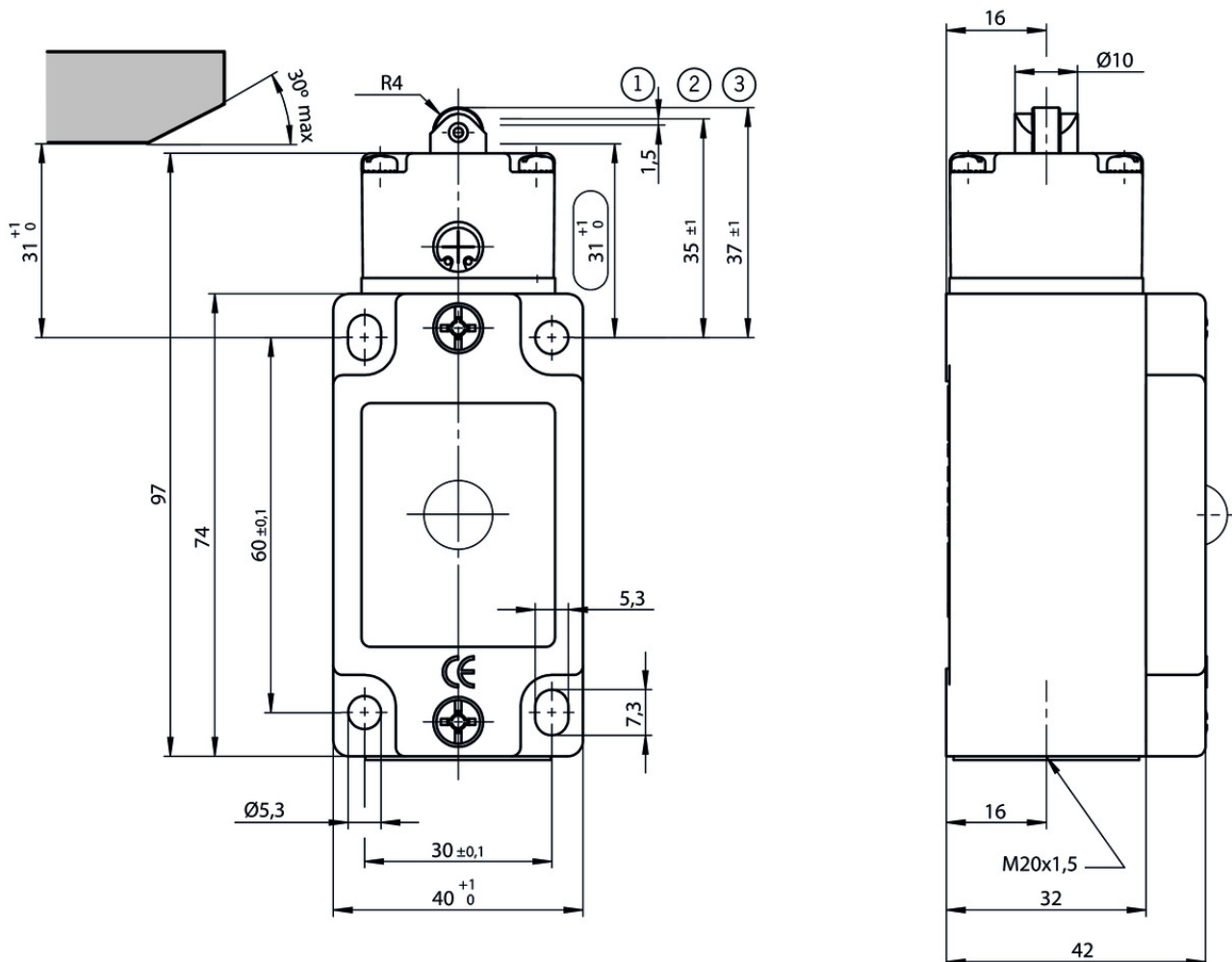

Legende

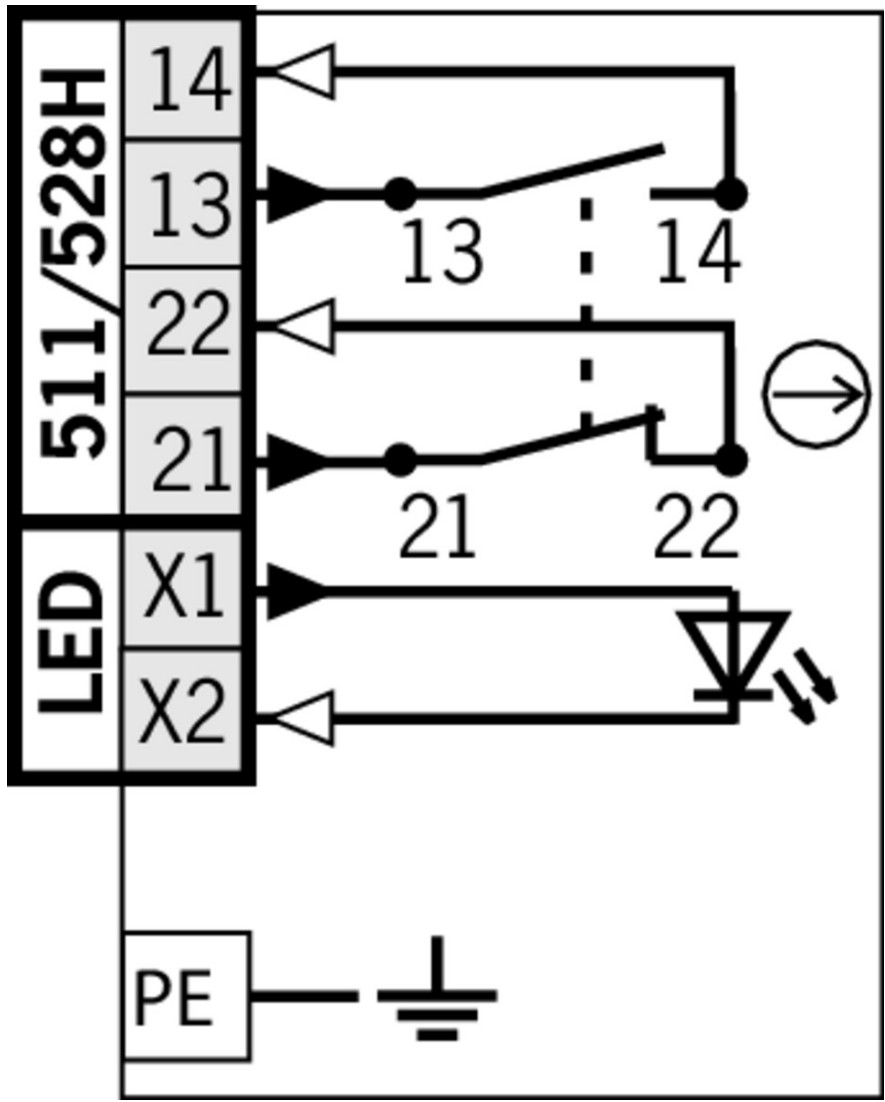

- 1 Operating point NO contact
- 2 Operating point NC contact
- 3 Free position

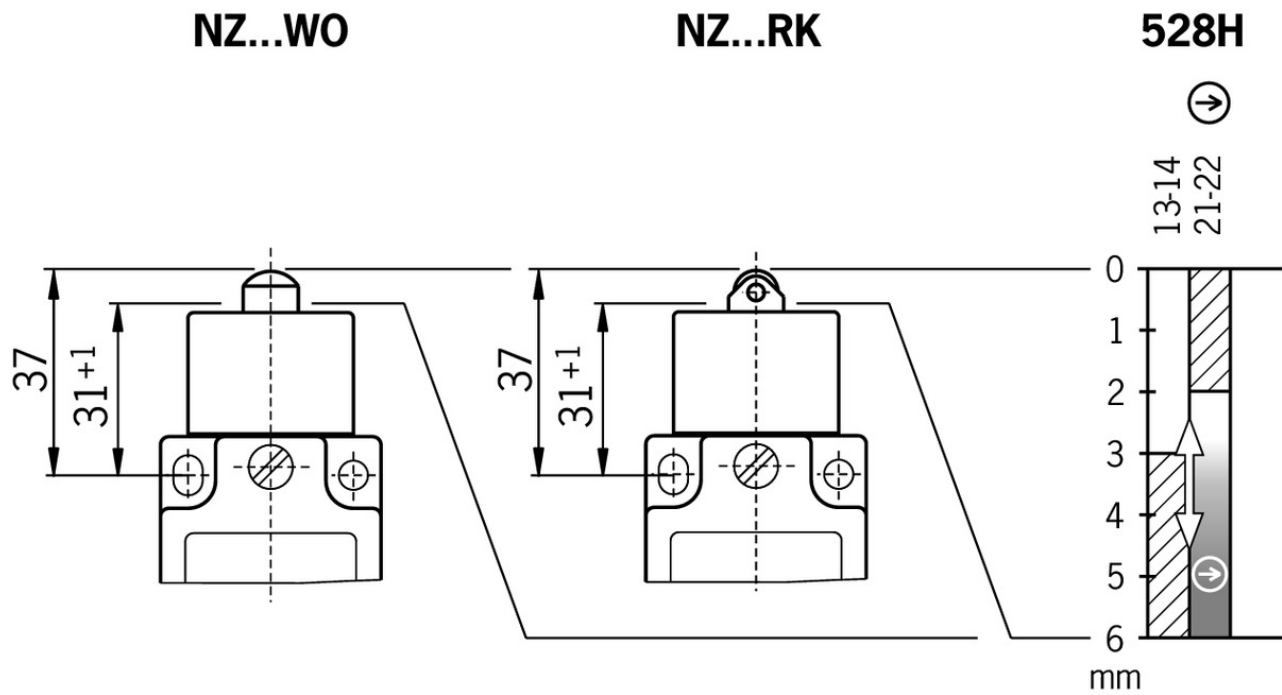

Travel diagram



Legende

-  Contacts closed
-  Contacts open
-  Contacts positively driven

Connection material

- Cable glands M20x1.5



077683 EKVM20/06



077684 EKVM20/09

Function expansion













- LED function display NZ



029220 NGLE060RT













Instructions

▼ Betriebsanleitung Sicherheitsschalter NZ.D.../NZ.W.../NZ.R...

	Doc. no.	Version	Language	Download
Betriebsanleitung Sicherheitsschalter NZ.D.../NZ.W.../NZ.R... Manual de instrucciones Interruptores de seguridad NZ.D.../NZ.W.../NZ.R... Mode d'emploi Interrupteur de sécurité NZ.D.../NZ.W.../NZ.R... Istruzioni di impiego Finecorsa di sicurezza NZ.D.../NZ.W.../NZ.R... Operating Instructions Safety Switch NZ.D.../NZ.W.../NZ.R...	074549	10-01/17	    	 1.8 MB
Instrukcja obsługi Wyłącznik bezpieczeństwa NZ.D.../NZ.W.../NZ.R...	074549	10-01/17		 0.4 MB
Инструкция по эксплуатации Предохранительный выключатель NZ.D.../NZ.W.../NZ.R...	074549	10-01/17		 0.6 MB
Návod na prevádzku Bezpečnostný spínač NZ.D.../NZ.W.../NZ.R...	074549	10-01/17		 0.4 MB







Catalogs











▼ Sicherheitsschalter mit Metallgehäuse Safety Switches with Metal Housing Bezpečnostní spínače s kovovým pouzdrém Interrupteurs de sécurité avec boîtier métallique 金属壳体 的安全开关 Interruptores de seguridad con carcasa metálica

	Doc. no.	Version	Language	Download
Sicherheitsschalter mit Metallgehäuse	100319	11-03/18		 7.9 MB
Interrupteurs de sécurité avec boîtier métallique	100676	11-03/18		 7.9 MB
Interruptores de seguridad con carcasa metálica	104856	11-03/18		 14.0 MB
Safety Switches with Metal Housing	100369	11-03/18		 7.9 MB
Bezpečnostní spínače s kovovým pouzdrém	121650	11-03/18		 7.9 MB
金属壳体 的安全开关	102453	11-03/18		 8.2 MB

Declaration of conformity

▼ EU prohlášení o shodě

	Doc. no.	Version	Language	Download
EU-Konformitätserklärung Declaración UE de conformidad Déclaration UE de conformité Dichiarazione di conformità EU declaration of conformity	2077153	25-02/17	    	 0.3 MB

EU prohlášení o shodě	2077153	25-02/17		 0.5 MB
EU-overensstemmelseserklæring				
Δήλωση συμμόρφωσης της ΕΕ				
EU-vaatimustenmukaisuusvakuutus				
EU-típusbizonyítvány				
EU-conformiteitsverklaring				
Deklaracja zgodności UE				
Declaração de Conformidade UE				
Declarația de conformitate UE				
EÚ vyhlásenie o zhode				

CAD data

CAD data for this item on TraceParts