

ITEM 090743 N1AW514SVM5-M

Description	Technical data	Accessories	Downloads
-------------	----------------	-------------	-----------

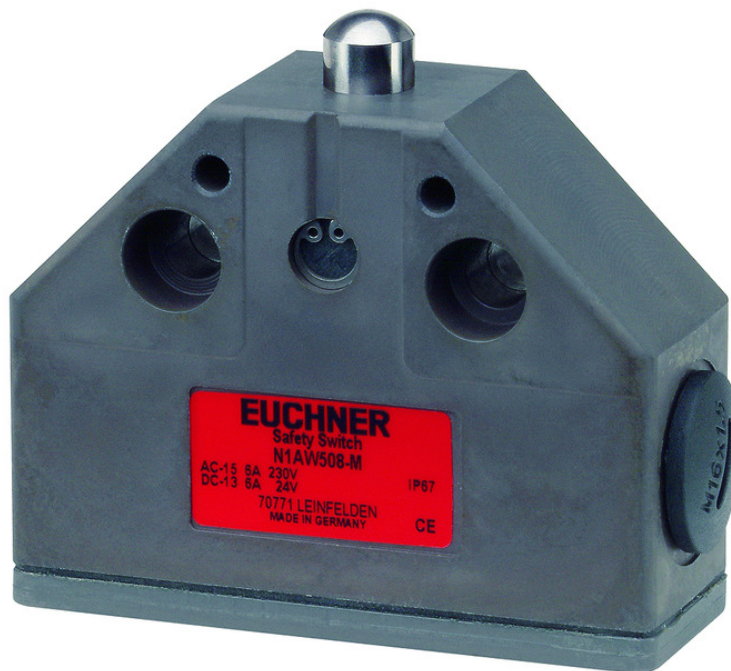

### Features

- › Housing according to DIN 43693
- › Plug connector SVM5

### Approach direction

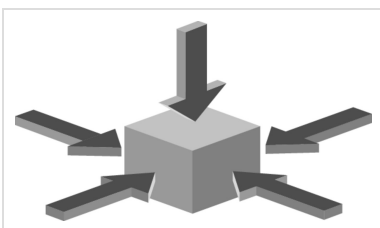

- › Figure  
Horizontal and vertical

### Switching element

**514** Snap-action switching contact 1 NC  $\rightarrow$  + 1 NO

⚠ To achieve the positively driven travel, the dimension  $\text{\textcircled{12-0.5}}$  must be maintained by the trip dog. Actuating elements such as dog approach guides must be firmly mounted in accordance with EN ISO 14119, i.e. riveted, welded or otherwise secured against becoming loose.

## Approvals



## Mechanical values and environment

Contact bounce time	$\leq 3\text{ms}$
Contact closing time	$\leq 5\text{ms}$
Design	Housing according to DIN 43693
Housing material	Anodized die-cast alloy
Weight	
Net	0,25 kg
Ambient temperature	-25 ... 80 °C
Degree of protection	IP67 [1]
Mechanical life	$1 \times 10^6$ [2]
Contact material	Silver alloy, gold flashed
Switching principle	Snap-action switching contact
Installation position	Any
Number of switching elements	1
Number of positively driven contacts	1
Number of NO contacts	1
Connection	
1 x	Plug connector M12 [3]
Approach speed	
max.	0,01 ... 10 m/min
Actuating element	Domed plunger
Actuating force	min.30 N

## Electrical connection ratings

Rated thermal current $I_{th}$	4 A
Utilization category according to EN 60947-5-1	
AC-15	2.5A 30V
DC-13	4A 24V
Short circuit protection according to IEC 60269-1	
(Fuse)	4A gG
Rated insulation voltage $U_i$	50 V
Rated impulse withstand voltage $U_{imp}$	1,5 kV
Switching current	
Min. at DC 24V	5 mA

## Reliability values acc. to EN ISO 13849-1

	Monitoring of the safety guard position
B10 <sub>D</sub>	$2 \times 10^6$

[1] Only screwed tight with the related mating connector.

[2] Mechanical life of switching element ES514.

[3] 5-pin, angle - plug connector: cable outlet adjustable max. 270°. Default setting for cable outlet downward.

### Dimension drawing

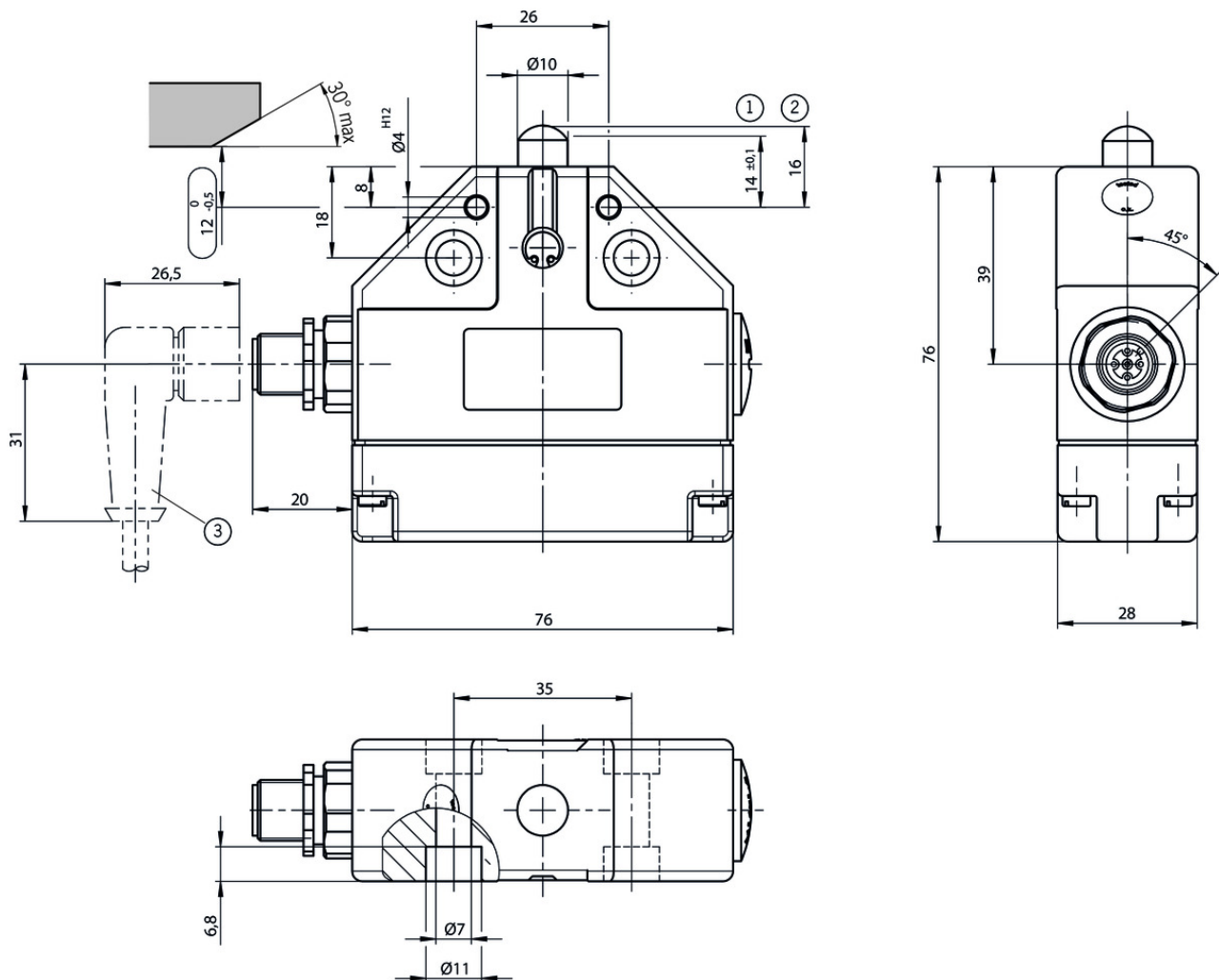

### Legende

1 Operating point

2 Free position

3 Angled plug connector, cable outlet adjustable to max. 270°. Default setting for cable outlet downward.

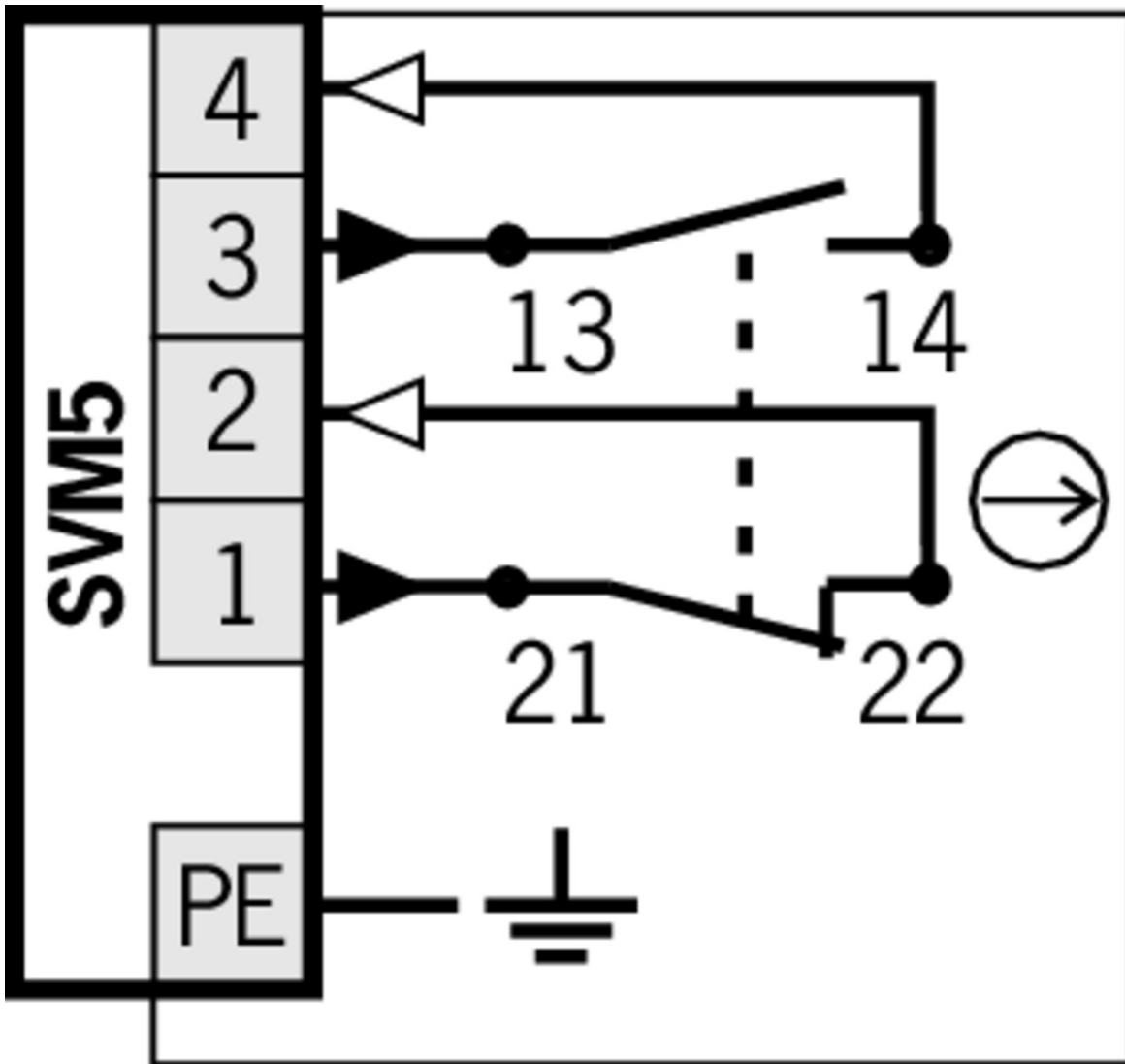

Travel diagram

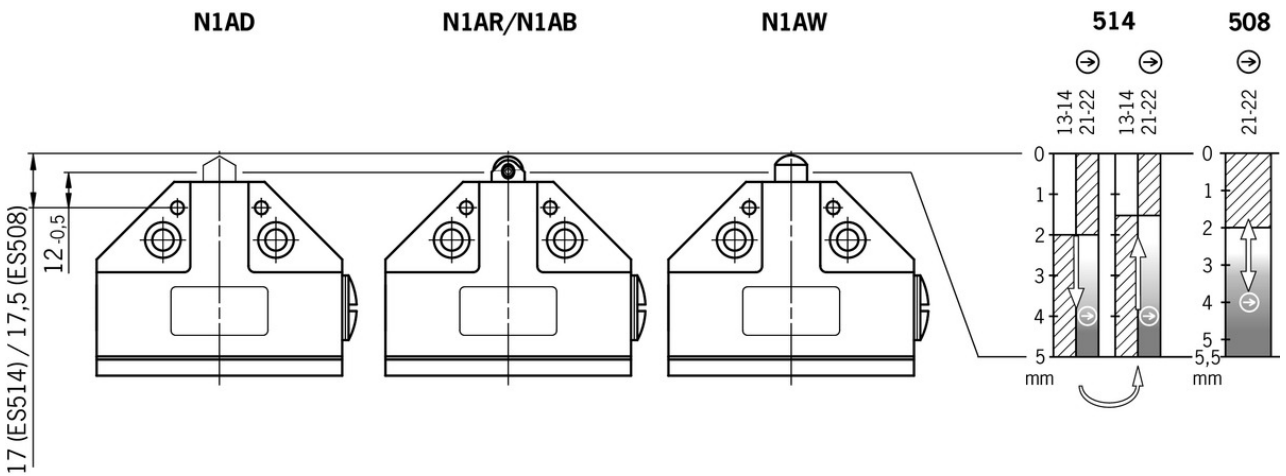

Legende

- Contacts closed
- Contacts open
- Contacts positively driven

## Connection material

### Connection cable with angled plug connector M12, 5-pin, 5m



**073462** C-M12F05-05X050PU05,0-GA-073462

#### Features

- › M12 female plug, 4-pin + PE
- › Angled plug connector
- › PUR cable
- › Halogen-free
- › Cable length 5 m
- › With flying lead
- › Cores color-coded

### Connection cable with straight plug connector M12, 5-pin, 5m







**073461** C-M12F05-05X050PU05,0-GA-073461

#### Features

- › M12 female plug, 4-pin + PE
- › Straight plug connector
- › PUR cable
- › Halogen-free
- › Cable length 5 m
- › With flying lead
- › Cores color-coded



## Instructions

### Manual de instrucciones Finales de carrera unitarios de precisión N1A

	Doc. no.	Version	Language	Download
Betriebsanleitung Präzisions-Einzelgrenztaster N1A Operating Instructions Precision Single Limit Switches N1A	2032309	12-01/18	 	 0.8 MB
Mode d'emploi Monopistes de précision N1A	2032309	12-01/18		 0.4 MB
Manual de instrucciones Finales de carrera unitarios de precisión N1A	2032309	12-01/18		 0.4 MB
Istruzioni di impiego Finecorsa di precisione singoli N1A	2032309	12-01/18		 0.4 MB













## Catalogs

### Positionsschalter und Reihengrenztaster Position Switches and Multiple Limit Switches Interrupteurs de position et boîtiers multipistes

	Doc. no.	Version	Language	Download
Positionsschalter und Reihengrenztaster	157835	01-03/18		 4.1 MB

Interrupteurs de position et boîtiers multipistes	157837	01-03/18		 4.1 MB
Position Switches and Multiple Limit Switches	157836	01-03/18		 4.1 MB

**Sicherheitsschalter mit Metallgehäuse Safety Switches with Metal Housing Bezpečnostní spínače s kovovým pouzdrém Interrupteurs de sécurité avec boîtier métallique 金属壳体 的安全开关 Interruptores de seguridad con carcasa metálica**

	Doc. no.	Version	Language	Download
Sicherheitsschalter mit Metallgehäuse	100319	11-03/18		 7.9 MB
Interrupteurs de sécurité avec boîtier métallique	100676	11-03/18		 7.9 MB
Interruptores de seguridad con carcasa metálica	104856	11-03/18		 14.0 MB
Safety Switches with Metal Housing	100369	11-03/18		 7.9 MB
Bezpečnostní spínače s kovovým pouzdrém	121650	11-03/18		 7.9 MB
金属壳体 的安全开关	102453	11-03/18		 8.2 MB

## Declaration of conformity

**EU prohlášení o shodě**

	Doc. no.	Version	Language	Download
EU-Konformitätserklärung Declaración UE de conformidad Déclaration UE de conformité Dichiarazione di conformità EU declaration of conformity	2077153	25-02/17	    	 0.3 MB
EU prohlášení o shodě EU-overensstemmelseserklæring Δήλωση συμμόρφωσης της ΕΕ EU-vaatimustenmukaisuusvakuutus EU-típusbizonyítvány EU-conformiteitsverklaring Deklaracja zgodności UE Declaração de Conformidade UE Declarația de conformitate UE EÚ vyhlásenie o zhode	2077153	25-02/17	        	 0.5 MB

## CAD data

CAD data for this item on TraceParts