

## ITEM 090845 NZ2HB-528

Description	Technical data	Accessories	Downloads
-------------	----------------	-------------	-----------



### Features

- › Type A according to EN 50041(plastic roller  $\varnothing$  18 mm)
- › Plug connector SR6

### Approach direction

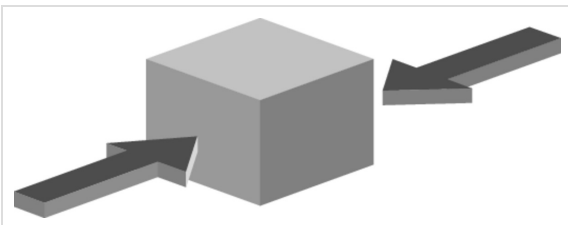

› Figure  
Horizontal

### Switching direction

- › Right, left or both sides

### Switching element

## Approvals



## Mechanical values and environment

Housing material	Anodized die-cast alloy
Weight	Net 0,3 kg
Ambient temperature	-25 ... 80 °C
Degree of protection	IP65
Mechanical life	30 x 10 <sup>6</sup>
Contact material	Silver alloy, gold flashed
Switching principle	Slow-action switching contact
Installation position	Any
Number of door position positively driven contacts	1
Number of NO contacts	1
Connection	1 x Plug connector SR6 <sup>[1]</sup>
Approach speed	max. 0,1 ... 300 m/min
Actuating element	Plain bearing plastic Lever arm <sup>[2]</sup>
Actuating force	min.15 N

## Electrical connection ratings

Rated thermal current I <sub>th</sub>	4 A
Utilization category according to EN 60947-5-1	AC-15 4A 230V DC-13 4A 24V
Short circuit protection according to IEC 60269-1	(Fuse) 4A gG
Rated insulation voltage U <sub>i</sub>	250 V
Rated impulse withstand voltage U <sub>imp</sub>	2,5 kV
Switching current	Min. at DC 24V 1 mA

## Reliability values acc. to EN ISO 13849-1



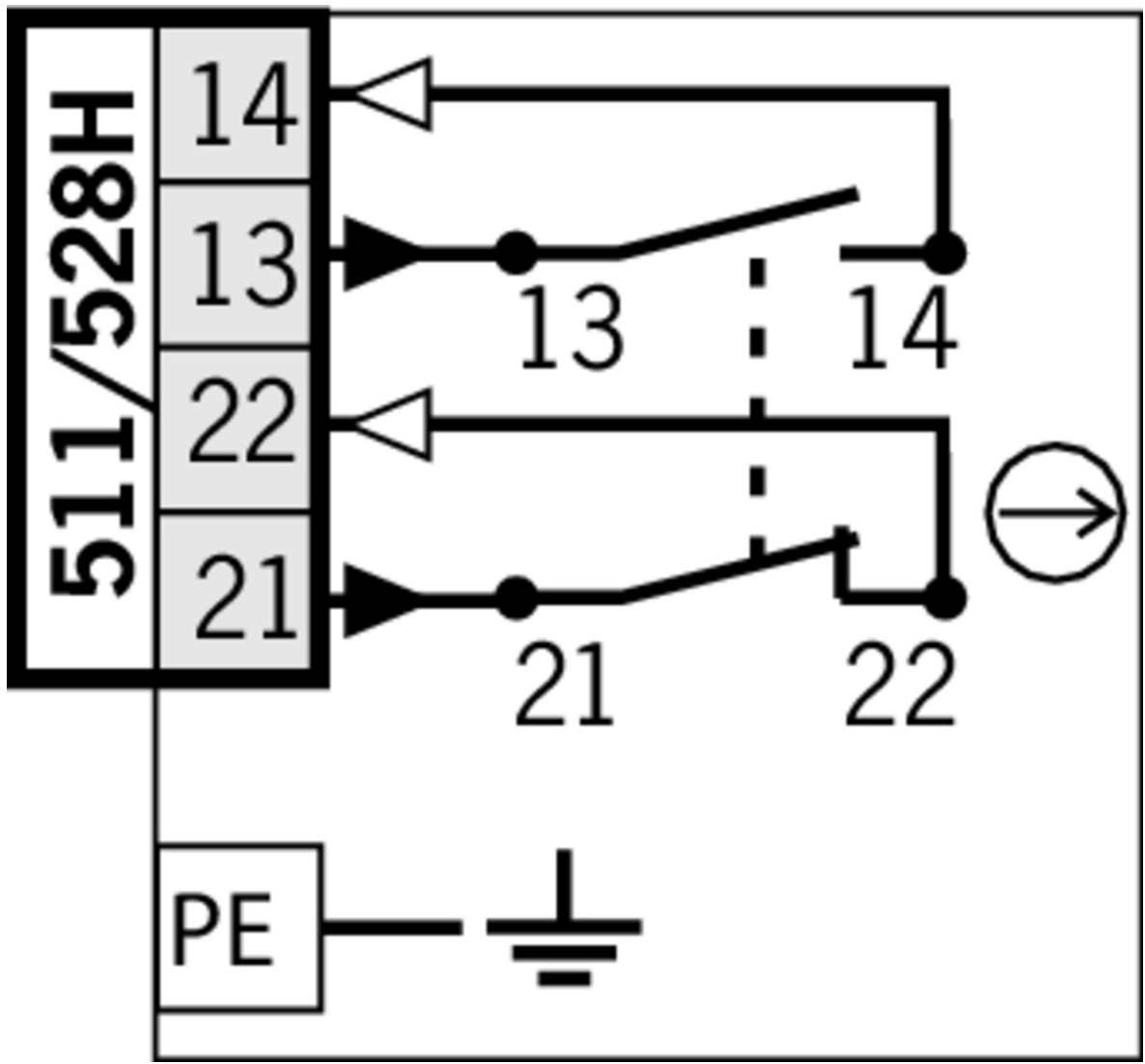

## Travel diagram

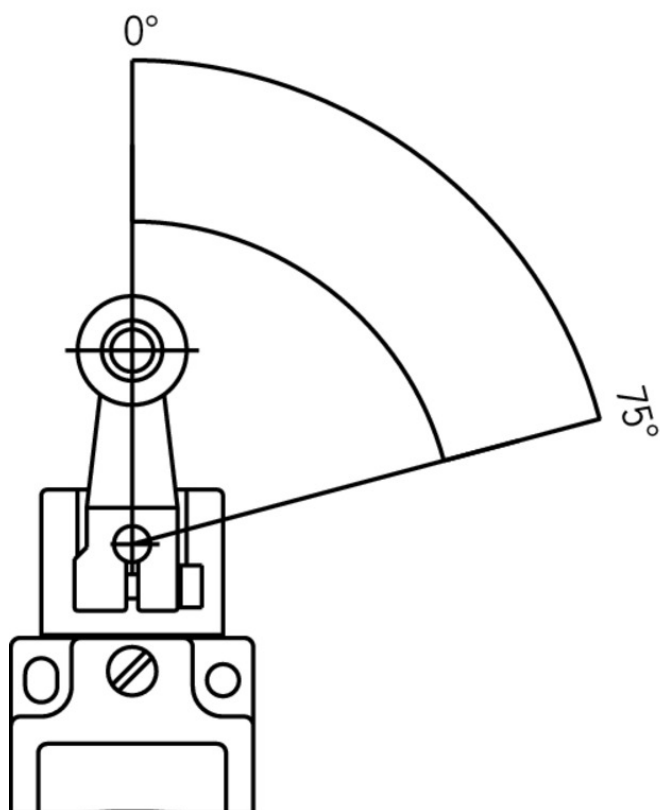

**NZ...HS**  
**NZ...HB**

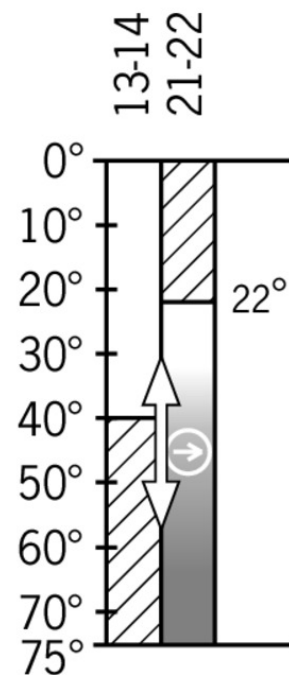

**528H**



## Legende

-  Contacts closed
-  Contacts open
-  Contacts positively driven

## Connection material

-  Plug connector SR6

**013178** SR6K

-  Features

- › Coding for plug connector SR6
- › Coding shells



**024999** SR6WFG11R

-  Features

- › Socket crimp contacts
- › 6-pin+PE

- › Contact carrier can be adjusted in 7 outlet directions

---

**087180** SR6AM2-M20

- ✔ Features
  - › Crimp contacts
  - › Male socket



**013176** SR6EF

- ✔ Features
  - › Crimp contacts
  - › Coding shells

- 
- ✔ Connection cable with plug connector SR6, 10m



**077633** C-M26F07-07X1,0PU10,0-MA-077633

- ✔ Features
  - › Female plug SR6, 6-pin + PE
  - › Straight plug connector
  - › PUR cable
  - › Cable length 10 m
  - › With flying lead

- 
- ✔ Connection cable with plug connector SR6, 5m



**077632** C-M26F07-07X1,0PU05,0-MA-077632

- ✔ Features
  - › Female plug SR6, 6-pin + PE
  - › Straight plug connector
  - › PUR cable
  - › Cable length 5 m
  - › With flying lead

- 
- ✔ Connection cable with plug connector SR6, 5m, angled



**077638** C-R22F07-07X1,0PU05,0-MA-077638

- ✔ Features
  - › Female plug SR6, 6-pin + PE
  - › Angled plug connector
  - › PUR cable
  - › Cable length 5 m
  - › With flying lead

- 
- ✔ Connection cable with plug connector SR6, 10m, angled



**077639** C-R22F07-07X1,0PU10,0-MA-077639

- ✔ Features
  - › Female plug SR6, 6-pin + PE
  - › Angled plug connector
  - › PUR cable
  - › Cable length 10 m
  - › With flying lead

- 
- ▼ Connection cable with plug connector SR6, 15m



**077634** C-M26F07-07X1,0PU15,0-MA-077634

- ▼ Features

- › Female plug SR6, 6-pin + PE
- › Straight plug connector
- › PUR cable
- › Cable length 15 m
- › With flying lead

- 
- ▼ Connection cable with plug connector SR6, 15m, angled



**077640** C-R22F07-07X1,0PU15,0-MA-077640

- ▼ Features

- › Female plug SR6, 6-pin + PE
- › Angled plug connector
- › PUR cable
- › Cable length 15 m
- › With flying lead

- 
- ▼ Connection cable with plug connector SR6, 20m



**098128** C-M26F07-07X1,0PU20,0-MA-098128

- ▼ Features

- › Female plug SR6, 6-pin + PE
- › Straight plug connector
- › PUR cable
- › Cable length 20 m
- › With flying lead

---

## Spare parts

- ▼ Lever arm with plastic roller



**012042** NHB ROLLENHEBEL

- ▼ Features

- › Plastic roller Ø18mm

---

## Instructions













- ▼ Betriebsanleitung Sicherheitsschalter NZ.H/P

Doc. no.    Version    Language    Download

Betriebsanleitung Sicherheitsschalter NZ.H/P Manual de instrucciones Interruptores de seguridad NZ.H/P Mode d'emploi Interrupteur de sécurité NZ.H/P Istruzioni di impiego Finecorsa di sicurezza NZ.H/P Operating Instructions Safety Switch NZ.H/P	074550	11-12/16	    	 2.1 MB
Instrukcja obsługi Wyłącznik bezpieczeństwa NZ.H/P	074550	11-12/16		 0.5 MB
Инструкция по эксплуатации Предохранительный выключатель NZ.H/P	074550	11-12/16		 0.6 MB
Návod na prevádzku Bezpečnostný spínač NZ.H/P	074550	11-12/16		 0.5 MB

## Catalogs

- Sicherheitsschalter mit Metallgehäuse Safety Switches with Metal Housing Bezpečnostní spínače s kovovým pouzdem Interrupteurs de sécurité avec boîtier métallique 金属壳体 的安全开关 Interruptores de seguridad con carcasa metálica

	Doc. no.	Version	Language	Download
Sicherheitsschalter mit Metallgehäuse	100319	11-03/18		 7.9 MB
Interrupteurs de sécurité avec boîtier métallique	100676	11-03/18		 7.9 MB
Interruptores de seguridad con carcasa metálica	104856	11-03/18		 14.0 MB
Safety Switches with Metal Housing	100369	11-03/18		 7.9 MB
Bezpečnostní spínače s kovovým pouzdem	121650	11-03/18		 7.9 MB
金属壳体 的安全开关	102453	11-03/18		 8.2 MB

## Declaration of conformity

- EU prohlášení o shodě

	Doc. no.	Version	Language	Download
EU-Konformitätserklärung Declaración UE de conformidad Déclaration UE de conformité Dichiarazione di conformità EU declaration of conformity	2077153	25-02/17	    	 0.3 MB
EU prohlášení o shodě EU-overensstemmelseserklæring Δήλωση συμμόρφωσης της ΕΕ EU-vaatimustenmukaisuusvakuutus EU-típusbizonyítvány EU-conformiteitsverklaring Deklaracja zgodności UE Declaração de Conformidade UE Declarația de conformitate UE EÚ vyhlásenie o zhode	2077153	25-02/17	        	 0.5 MB

## CAD data

CAD data for this item on TraceParts