

## ITEM 090856 NZ2HS-3131

Description	Technical data	Accessories	Downloads
-------------	----------------	-------------	-----------



### Features

- › Version A according to EN 50041(steel roller  $\varnothing$  18 mm)
- › Plug connector SR11

### Approach direction

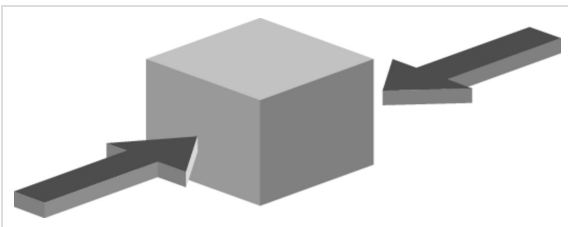

- › Figure  
Horizontal

### Switching direction

- › Right, left or both sides

### Switching element

## 3131H Slow-action switching contact 2 NC $\oplus$ + 2 NO

### Approvals



### Mechanical values and environment

Housing material	Anodized die-cast alloy
Weight	Net 0,3 kg
Ambient temperature	-25 ... 80 °C
Degree of protection	IP65
Mechanical life	30 x 10 <sup>6</sup>
Contact material	Silver alloy, gold flashed
Switching principle	Slow-action switching contact
Installation position	Any
Number of door position positively driven contacts	2
Number of NO contacts	2
Connection	1 x Plug connector SR11 [1]
Approach speed	max. 0,1 ... 60 m/min
Actuating element	Plain bearing metal Lever arm [2]
Actuating force	min.15 N

### Electrical connection ratings

Rated thermal current I <sub>th</sub>	4 A
Utilization category according to EN 60947-5-1	AC-15 4A 50V DC-13 4A 24V
Short circuit protection according to IEC 60269-1	(Fuse) 4A gG
Rated insulation voltage U <sub>i</sub>	50 V
Rated impulse withstand voltage U <sub>imp</sub>	1,5 kV
Switching current	Min. at DC 24V 1 mA

### Reliability values acc. to EN ISO 13849-1

B10<sub>D</sub>

Monitoring of the safety guard position

20 x 10<sup>6</sup>

[1] 11-pin + PE

[2] d roller = 18 mm, length = 32 mm

Dimension drawing

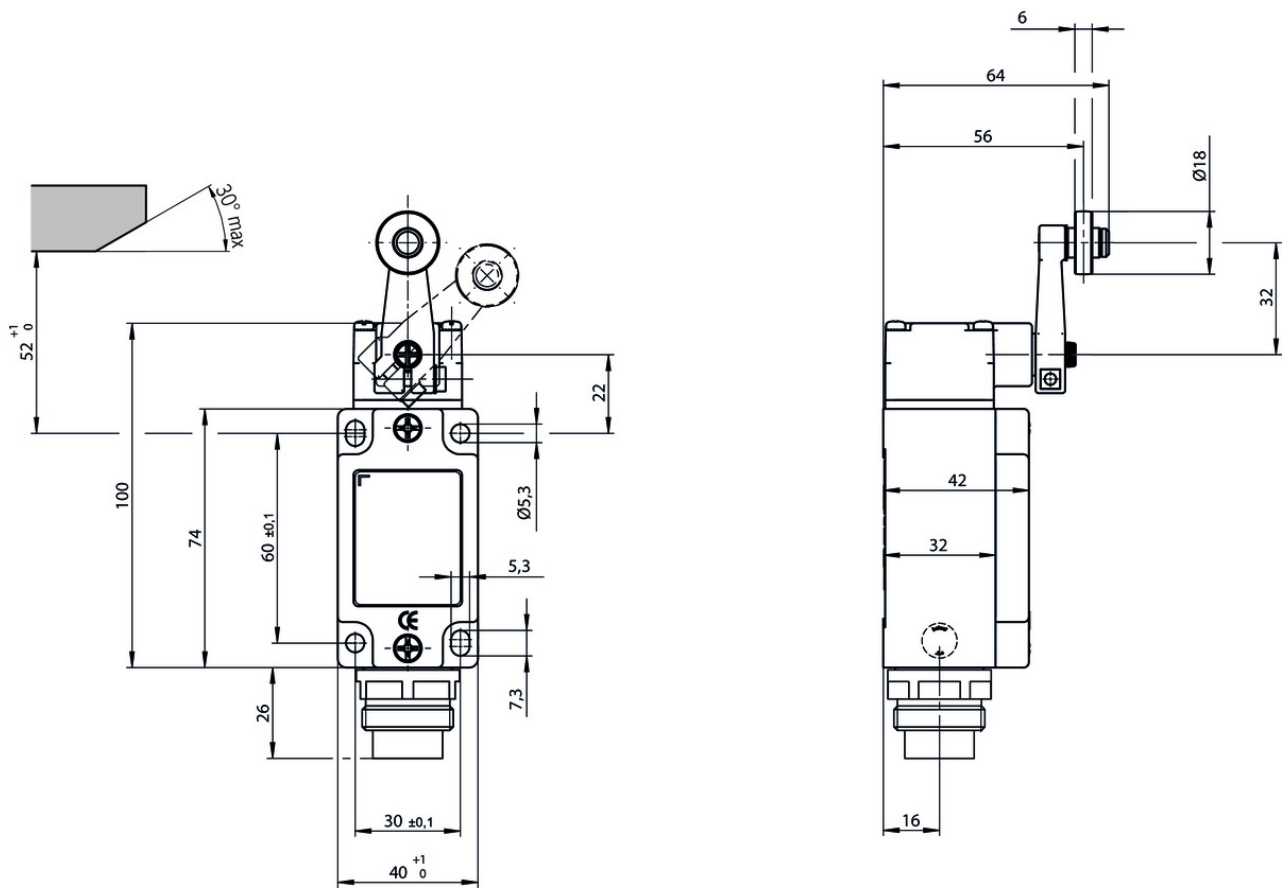

3131H

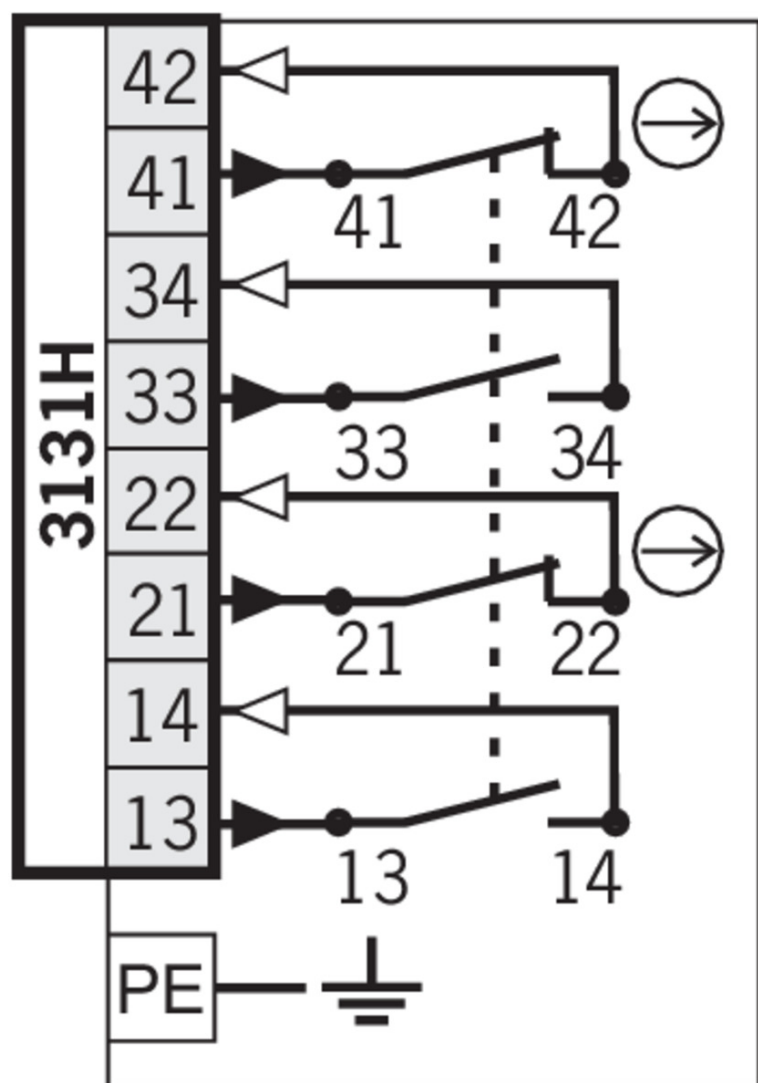

## Travel diagram

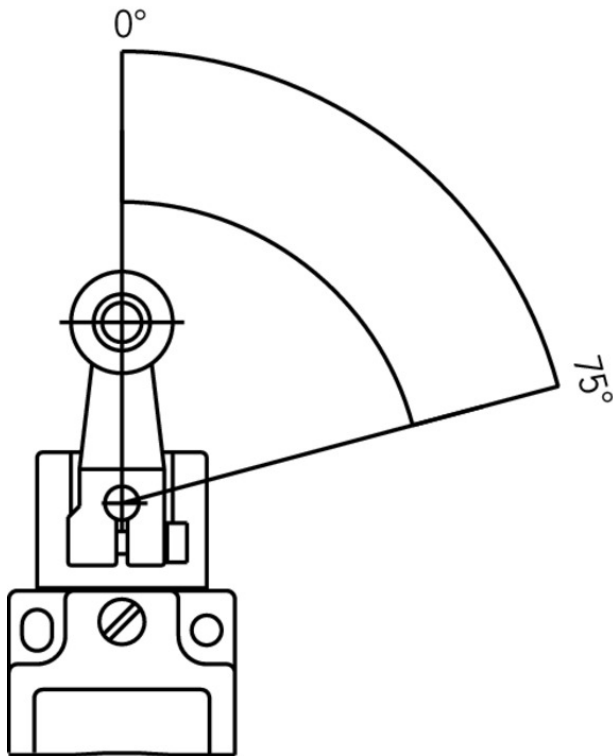

**NZ...HS**  
**NZ...HB**

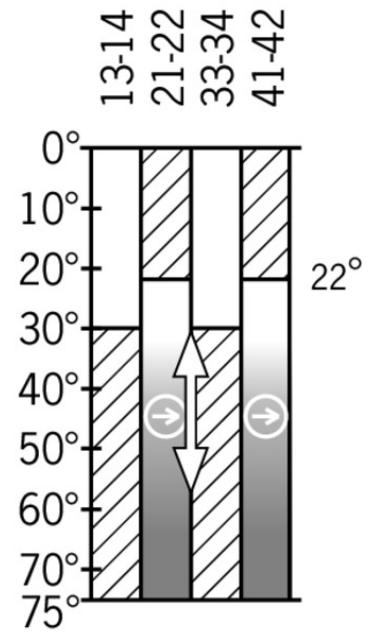

**3131H**



## Legende

-  Contacts closed
-  Contacts open
-  Contacts positively driven

## Connection material

-  Plug connector SR11 for safety switches NZ and TZ

### **070859** SR11EF

-  Features
  - › Crimp contacts
  - › Cable optional
  - › Coding shells

### **054773** SR11WF

-  Features
  - › Crimp contacts
  - › 90° angled optional
  - › Cable optional

- › Coding shells

---

**091296** SR11AM2-M20

- ▣ Features
  - › Crimp contacts
  - › Cable optional
  - › Coding shells

- 
- ▣ Connection cable with plug connector SR11, 5m



**077629** C-M26F12-12X1,00PU05,0-MA-077629

- ▣ Features
  - › Female plug SR11, 11-pin + PE
  - › Straight plug connector
  - › PUR cable
  - › Cable length 5 m
  - › With flying lead

- 
- ▣ Connection cable with plug connector SR11, 5m, angled



**077635** C-M26F12-12X1,0PU05,0-MA-077635

- ▣ Features
  - › Female plug SR11, 11-pin + PE
  - › Angled plug connector
  - › PUR cable
  - › Cable length 5 m
  - › With flying lead

- 
- ▣ Connection cable with plug connector SR11, 10m



**077630** C-M26F12-12X1,00PU10,0-MA-077630

- ▣ Features
  - › Female plug SR11, 11-pin + PE
  - › Straight plug connector
  - › PUR cable
  - › Cable length 10 m
  - › With flying lead

- 
- ▣ Connection cable with plug connector SR11, 10m, angled



**077636** C-M26F12-12X1,0PU10,0-MA-077636

- ▣ Features
  - › Female plug SR11, 11-pin + PE
  - › Angled plug connector
  - › PUR cable
  - › Cable length 10 m
  - › With flying lead

- 
- ▣ Connection cable with plug connector SR11, 15m

**077631** C-M26F12-12X1,00PU15,0-MA-077631



- ✓ Features
    - › Female plug SR11, 11-pin + PE
    - › Straight plug connector
    - › PUR cable
    - › Cable length 15 m
    - › With flying lead
- 

- ✓ Connection cable with plug connector SR11, 15m, angled



**077637** C-M26F12-12X1,0PU15,0-MA-077637

- ✓ Features
    - › Female plug SR11, 11-pin + PE
    - › Angled plug connector
    - › PUR cable
    - › Cable length 15 m
    - › With flying lead
- 

- ✓ Connection cable with plug connector SR11, 20m



**096632** C-M26F12-12X1,0PU20,0-MA-096632

- ✓ Features
    - › Female plug SR11, 11-pin + PE
    - › Straight plug connector
    - › PUR cable
    - › Cable length 20 m
    - › With flying lead
- 

- ✓ Connection cable with plug connector SR11, 25m



**094749** C-M26F12-12X1,0PU25,0-MA-094749

- ✓ Features
    - › Female plug SR11, 11-pin + PE
    - › Straight plug connector
    - › PUR cable
    - › Cable length 25 m
    - › With flying lead
- 

## Spare parts

---

- ✓ Lever arm with steel roller



**012043** NHS ROLLENHEBEL

- ✓ Features
    - › Steel roller Ø18mm
- 













## Instructions

## ▼ Betriebsanleitung Sicherheitsschalter NZ.H/P

	Doc. no.	Version	Language	Download
Betriebsanleitung Sicherheitsschalter NZ.H/P Manual de instrucciones Interruptores de seguridad NZ.H/P Mode d'emploi Interrupteur de sécurité NZ.H/P Istruzioni di impiego Finecorsa di sicurezza NZ.H/P Operating Instructions Safety Switch NZ.H/P	074550	11-12/16	    	 2.1 MB
Instrukcja obsługi Wyłącznik bezpieczeństwa NZ.H/P	074550	11-12/16		 0.5 MB
Инструкция по эксплуатации Предохранительный выключатель NZ.H/P	074550	11-12/16		 0.6 MB
Návod na prevádzku Bezpečnostný spínač NZ.H/P	074550	11-12/16		 0.5 MB

## Catalogs

### ▼ Sicherheitsschalter mit Metallgehäuse Safety Switches with Metal Housing Bezpečnostní spínače s kovovým pouzdem Interrupteurs de sécurité avec boîtier métallique 金属壳体 的安全开关 Interruptores de seguridad con carcasa metálica

	Doc. no.	Version	Language	Download
Sicherheitsschalter mit Metallgehäuse	100319	11-03/18		 7.9 MB
Interrupteurs de sécurité avec boîtier métallique	100676	11-03/18		 7.9 MB
Interruptores de seguridad con carcasa metálica	104856	11-03/18		 14.0 MB
Safety Switches with Metal Housing	100369	11-03/18		 7.9 MB
Bezpečnostní spínače s kovovým pouzdem	121650	11-03/18		 7.9 MB
金属壳体 的安全开关	102453	11-03/18		 8.2 MB

## Declaration of conformity

### ▼ EU prohlášení o shodě

	Doc. no.	Version	Language	Download
EU-Konformitätserklärung Declaración UE de conformidad Déclaration UE de conformité Dichiarazione di conformità EU declaration of conformity	2077153	25-02/17	    	 0.3 MB
EU prohlášení o shodě EU-overensstemmelseserklæring Δήλωση συμμόρφωσης της ΕΕ EU-vaatimustenmukaisuusvakuutus EU-típusbizonyítvány EU-conformiteitsverklaring Deklaracja zgodności UE Declaração de Conformidade UE Declarația de conformitate UE EÚ vyhlásenie o zhode	2077153	25-02/17	        	 0.5 MB

## CAD data



CAD data for this item on TraceParts