

ITEM 090874 NZ1PS-528-M

Description	Technical data	Accessories	Downloads
-------------	----------------	-------------	-----------



Features

- › Steel roller \varnothing 18 mm
- › Cable entry M20 x 1.5

Approach direction

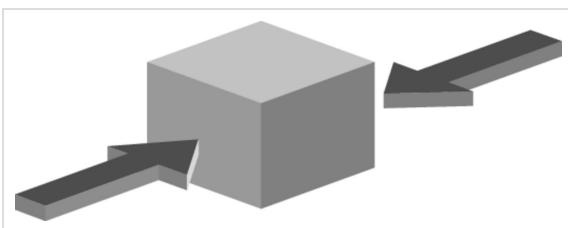

› Figure
Horizontal

Switching direction

Right, left or both sides

Lever arm adjustment

Lever arm length can be adjusted from 28 mm to 78 mm in steps of 12.5 mm.

Switching element

528H Slow-action switching contact 1 NC \ominus + 1 NO

Approvals



Mechanical values and environment

Housing material	Anodized die-cast alloy
Weight	Net 0,3 kg
Ambient temperature	-25 ... 80 °C
Degree of protection	IP67
Mechanical life	30 x 10 ⁶
Contact material	Silver alloy, gold flashed
Switching principle	Slow-action switching contact
Installation position	Any
Number of door position positively driven contacts	1
Number of NO contacts	1
Connection	1 x M20 x 1.5
Approach speed	max. 0,5 ... 30 m/min
Actuating element	Plain bearing metal
	Lever arm adjustable ^[1]
Actuating force	min.15 N

Electrical connection ratings

Rated thermal current I _{th}	4 A
Utilization category according to EN 60947-5-1	AC-15 4A 230V DC-13 4A 24V
Short circuit protection according to IEC 60269-1	(Fuse) 4A gG
Rated insulation voltage U _i	250 V
Rated impulse withstand voltage U _{imp}	2,5 kV
Switching current	

Min. at DC 24V	1 mA
Connection cross-section	0,34 ... 1,5 mm ²

Reliability values acc. to EN ISO 13849-1

	Monitoring of the safety guard position
B10D	20 x 10 ⁶

[1] d roller = 18 mm, length 28 - 78 mm

Dimension drawing

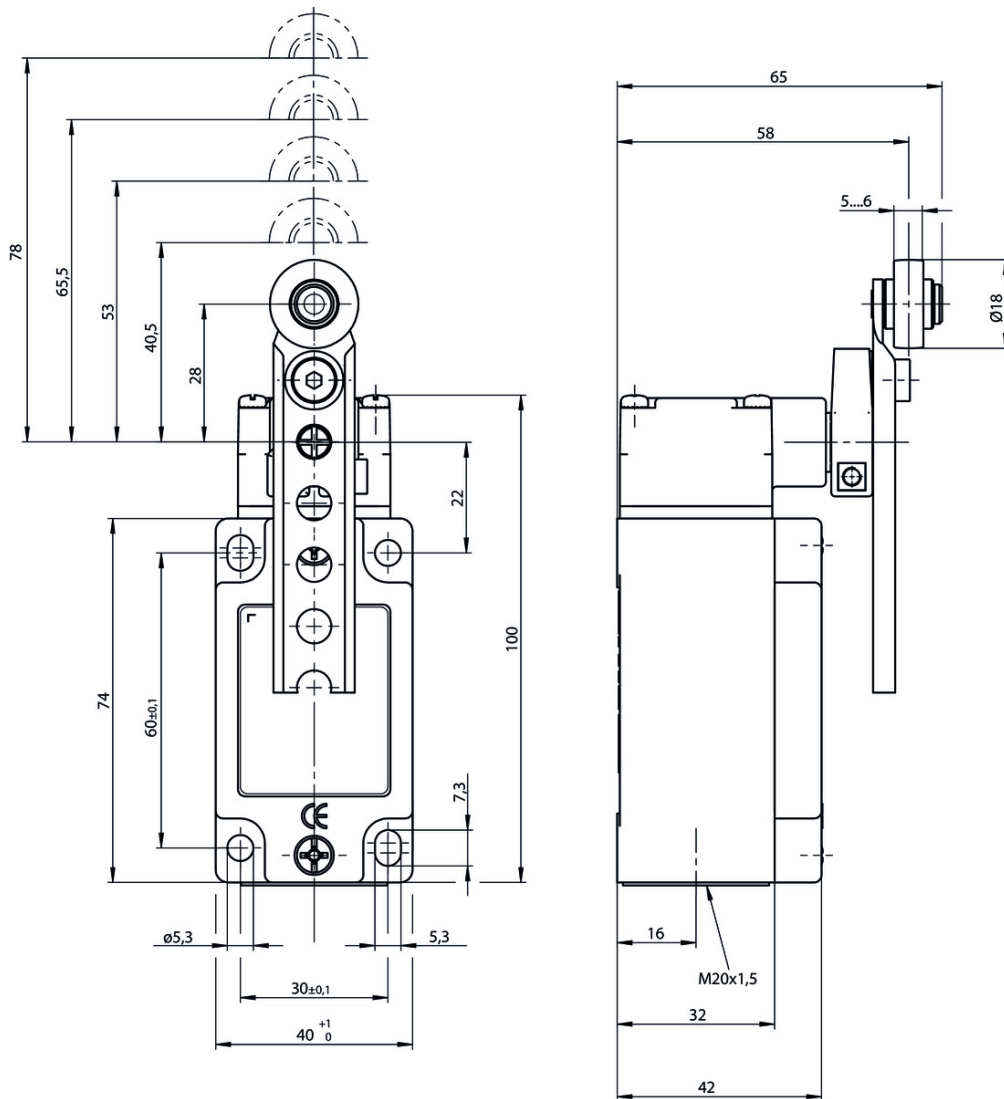

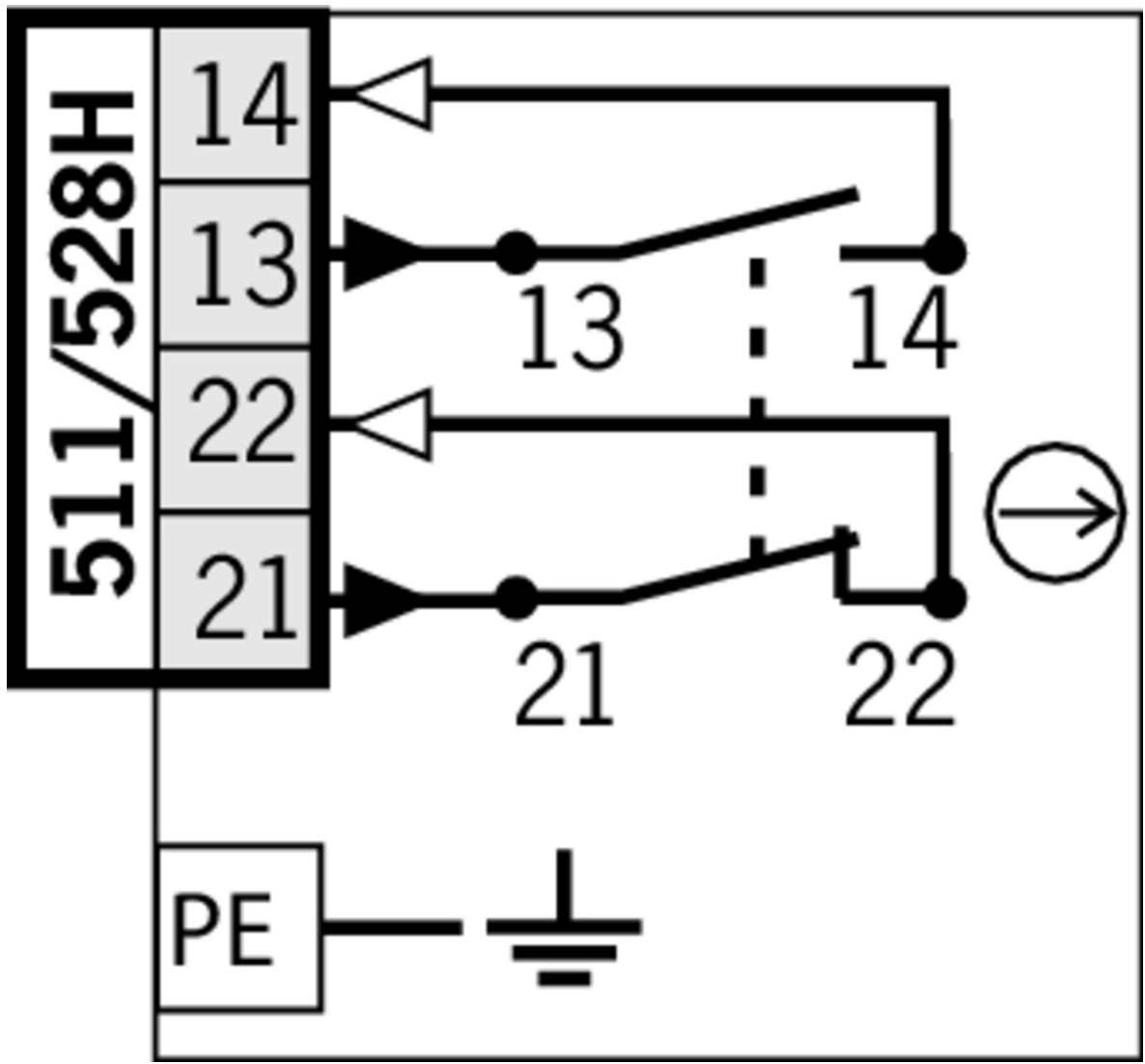

Travel diagram

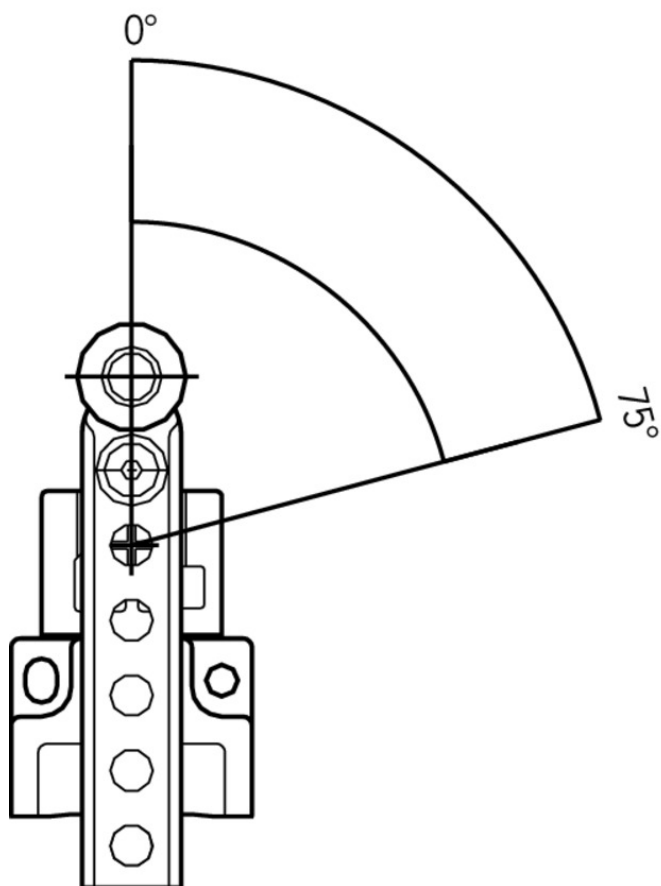

NZ...PS
NZ...PB

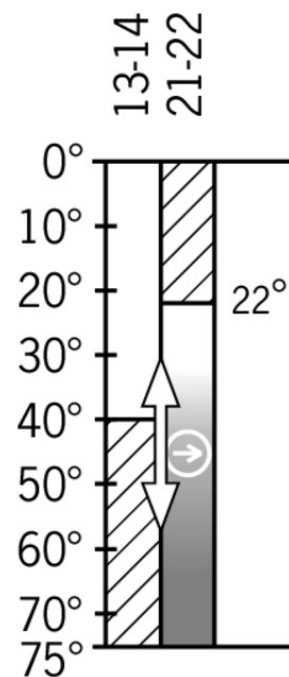

528H



Legende

-  Contacts closed
-  Contacts open
-  Contacts positively driven

Connection material

 Cable glands M20x1.5



077683 EKVM20/06



077684 EKVM20/09











Instructions

▼ Betriebsanleitung Sicherheitsschalter NZ.H/P

	Doc. no.	Version	Language	Download
Betriebsanleitung Sicherheitsschalter NZ.H/P Manual de instrucciones Interruptores de seguridad NZ.H/P Mode d'emploi Interrupteur de sécurité NZ.H/P Istruzioni di impiego Finecorsa di sicurezza NZ.H/P Operating Instructions Safety Switch NZ.H/P	074550	11-12/16	    	 2.1 MB
Instrukcja obsługi Wyłącznik bezpieczeństwa NZ.H/P	074550	11-12/16		 0.5 MB
Инструкция по эксплуатации Предохранительный выключатель NZ.H/P	074550	11-12/16		 0.6 MB
Návod na prevádzku Bezpečnostný spínač NZ.H/P	074550	11-12/16		 0.5 MB







Catalogs











▼ Sicherheitsschalter mit Metallgehäuse Safety Switches with Metal Housing Bezpečnostní spínače s kovovým pouzdem Interrupteurs de sécurité avec boîtier métallique 金属壳体 的安全开关 Interruptores de seguridad con carcasa metálica

	Doc. no.	Version	Language	Download
Sicherheitsschalter mit Metallgehäuse	100319	11-03/18		 7.9 MB
Interrupteurs de sécurité avec boîtier métallique	100676	11-03/18		 7.9 MB
Interruptores de seguridad con carcasa metálica	104856	11-03/18		 14.0 MB
Safety Switches with Metal Housing	100369	11-03/18		 7.9 MB
Bezpečnostní spínače s kovovým pouzdem	121650	11-03/18		 7.9 MB
金属壳体 的安全开关	102453	11-03/18		 8.2 MB

Declaration of conformity

▼ EU prohlášení o shodě

	Doc. no.	Version	Language	Download
EU-Konformitätserklärung Declaración UE de conformidad Déclaration UE de conformité Dichiarazione di conformità EU declaration of conformity	2077153	25-02/17	    	 0.3 MB

EU prohlášení o shodě	2077153	25-02/17		 0.5 MB
EU-overensstemmelseserklæring				
Δήλωση συμμόρφωσης της ΕΕ				
EU-vaatimustenmukaisuusvakuutus				
EU-típusbizonyítvány				
EU-conformiteitsverklaring				
Deklaracja zgodności UE				
Declaração de Conformidade UE				
Declarația de conformitate UE				
EÚ vyhlásenie o zhode				

CAD data

CAD data for this item on TraceParts