

ITEM 091264 NZ2HS-2121

| Description | Technical data | Accessories | Downloads |
|-------------|----------------|-------------|-----------|
|-------------|----------------|-------------|-----------|



Features

- › Version A according to EN 50041(steel roller \varnothing 18 mm)
- › Plug connector SR11

Approach direction

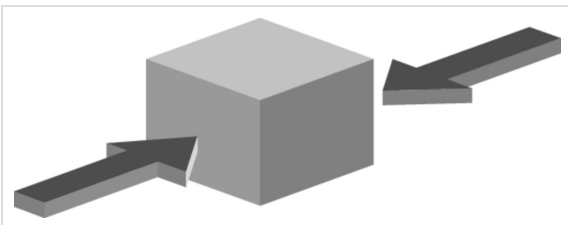

- › Figure
Horizontal

Switching direction

- › Right, left or both sides

Switching element

Approvals



Mechanical values and environment

| | | |
|--|--|--------------------------|
| Housing material | Anodized die-cast alloy | |
| Weight | Net | 0,3 kg |
| | Ambient temperature | -25 ... 80 °C |
| Degree of protection | IP65 | |
| Mechanical life | 30 x 10 ⁶ | |
| Contact material | Silver alloy, gold flashed | |
| Switching principle | Slow-action switching contact | |
| Installation position | Any | |
| Number of door position positively driven contacts | 4 | |
| Connection | 1 x Plug connector SR11 ^[1] | |
| | Approach speed | max. 0,1 ... 60 m/min |
| Actuating element | Plain bearing metal | Lever arm ^[2] |
| | Actuating force | min.15 N |

Electrical connection ratings

| | | |
|--|---|--------|
| Rated thermal current I _{th} | 4 A | |
| Utilization category according to EN 60947-5-1 | AC-15 | 4A 50V |
| | DC-13 | 4A 24V |
| | Short circuit protection according to IEC 60269-1 | (Fuse) |
| Rated insulation voltage U _i | 50 V | |
| Rated impulse withstand voltage U _{imp} | 1,5 kV | |
| Switching current | Min. at DC 24V 1 mA | |

Reliability values acc. to EN ISO 13849-1

B10_D

Monitoring of the safety guard position

20 x 10⁶

[1] 11-pin + PE

[2] d roller = 18 mm, length 32 mm

Dimension drawing

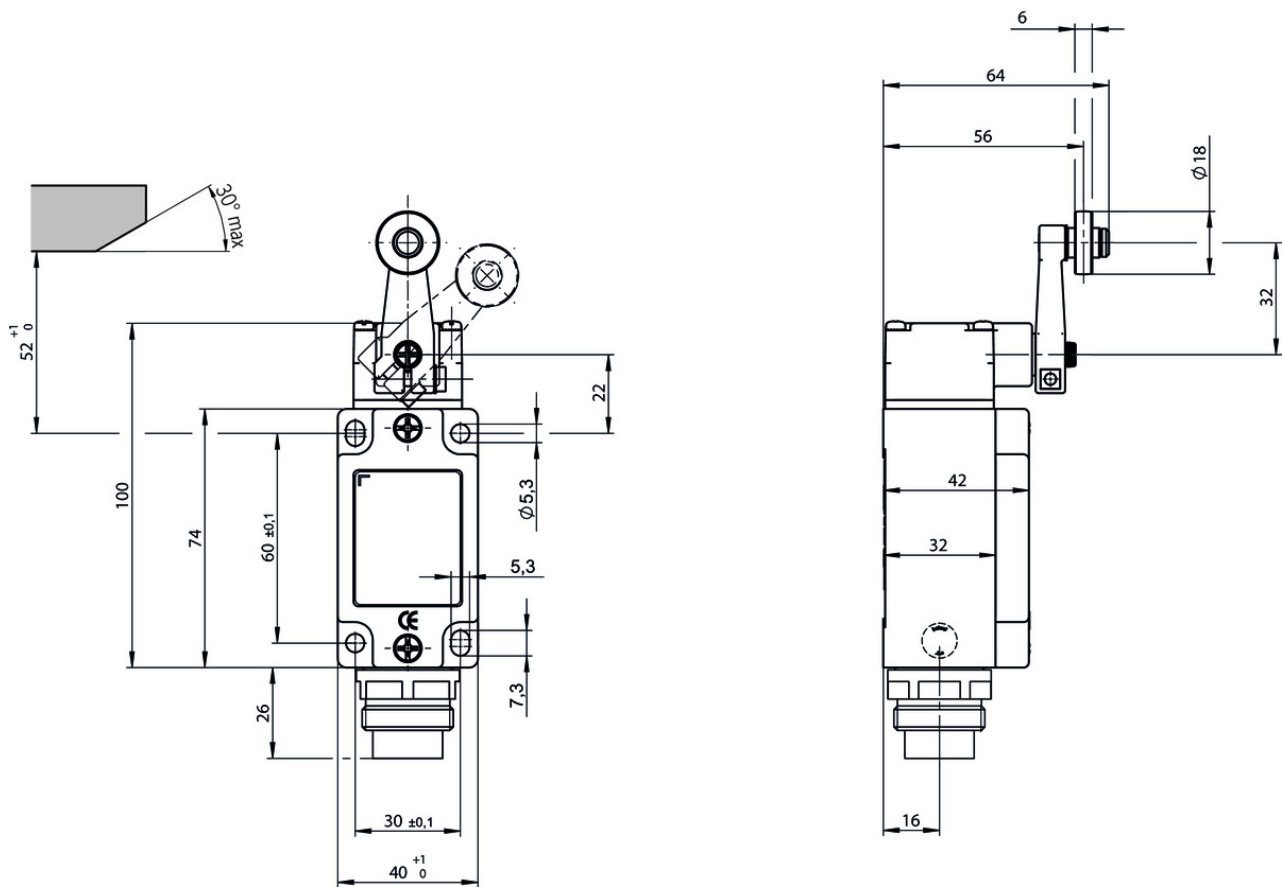

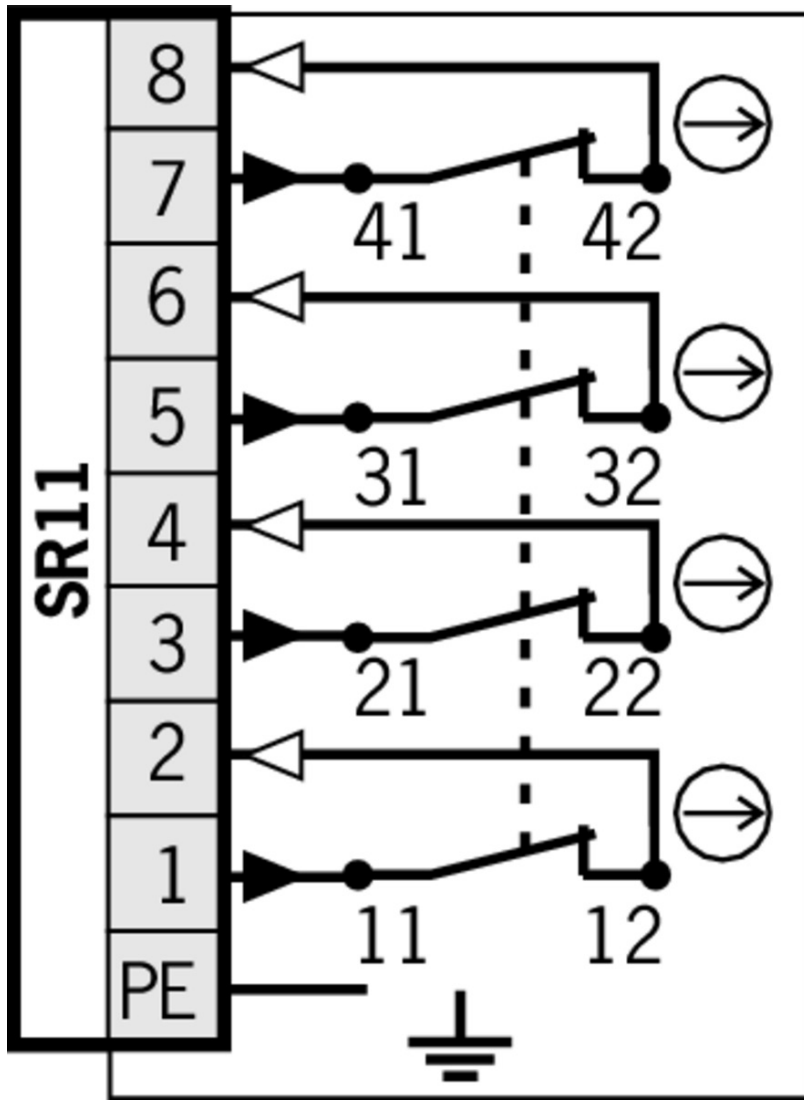

Travel diagram

NZ...HS
NZ...HB

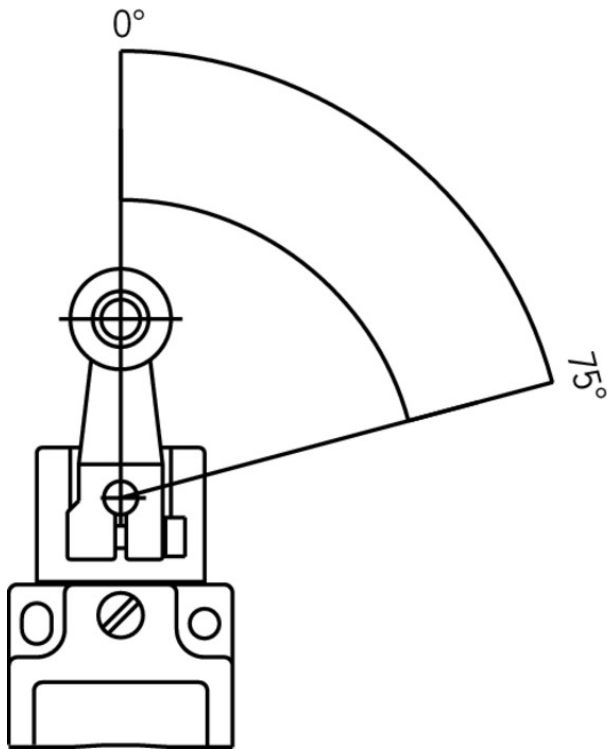



2121H

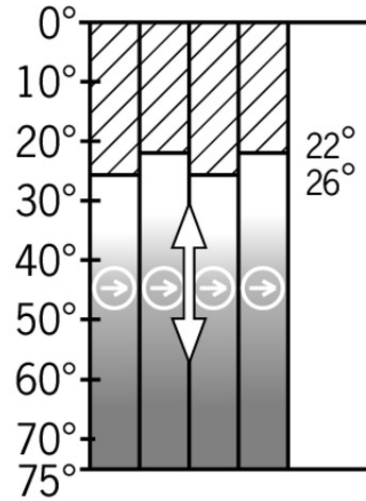

11-12
21-22
31-32
41-42



Legende

-  Contacts closed
-  Contacts open
-  Contacts positively driven

Connection material

-  Plug connector SR11 for safety switches NZ and TZ

070859 SR11EF

Features

- › Crimp contacts
- › Cable optional
- › Coding shells

054773 SR11WF

Features

- › Crimp contacts
- › 90° angled optional
- › Cable optional

- › Coding shells

091296 SR11AM2-M20

▼ Features

- › Crimp contacts
- › Cable optional
- › Coding shells

▼ Connection cable with plug connector SR11, 5m



077629 C-M26F12-12X1,00PU05,0-MA-077629

▼ Features

- › Female plug SR11, 11-pin + PE
- › Straight plug connector
- › PUR cable
- › Cable length 5 m
- › With flying lead

▼ Connection cable with plug connector SR11, 5m, angled



077635 C-M26F12-12X1,0PU05,0-MA-077635

▼ Features

- › Female plug SR11, 11-pin + PE
- › Angled plug connector
- › PUR cable
- › Cable length 5 m
- › With flying lead

▼ Connection cable with plug connector SR11, 10m



077630 C-M26F12-12X1,00PU10,0-MA-077630

▼ Features

- › Female plug SR11, 11-pin + PE
- › Straight plug connector
- › PUR cable
- › Cable length 10 m
- › With flying lead

▼ Connection cable with plug connector SR11, 10m, angled



077636 C-M26F12-12X1,0PU10,0-MA-077636

▼ Features

- › Female plug SR11, 11-pin + PE
- › Angled plug connector
- › PUR cable
- › Cable length 10 m
- › With flying lead

▼ Connection cable with plug connector SR11, 15m

077631 C-M26F12-12X1,00PU15,0-MA-077631



- ✓ Features
 - › Female plug SR11, 11-pin + PE
 - › Straight plug connector
 - › PUR cable
 - › Cable length 15 m
 - › With flying lead
-

- ✓ Connection cable with plug connector SR11, 15m, angled



077637 C-M26F12-12X1,0PU15,0-MA-077637

- ✓ Features
 - › Female plug SR11, 11-pin + PE
 - › Angled plug connector
 - › PUR cable
 - › Cable length 15 m
 - › With flying lead
-

- ✓ Connection cable with plug connector SR11, 20m



096632 C-M26F12-12X1,0PU20,0-MA-096632

- ✓ Features
 - › Female plug SR11, 11-pin + PE
 - › Straight plug connector
 - › PUR cable
 - › Cable length 20 m
 - › With flying lead
-

- ✓ Connection cable with plug connector SR11, 25m



094749 C-M26F12-12X1,0PU25,0-MA-094749

- ✓ Features
 - › Female plug SR11, 11-pin + PE
 - › Straight plug connector
 - › PUR cable
 - › Cable length 25 m
 - › With flying lead
-

Spare parts

- ✓ Lever arm with steel roller



012043 NHS ROLLENHEBEL

- ✓ Features
 - › Steel roller Ø18mm
-













Instructions

▼ Betriebsanleitung Sicherheitsschalter NZ.H/P

| | Doc. no. | Version | Language | Download |
|--|----------|----------|---|--|
| Betriebsanleitung Sicherheitsschalter NZ.H/P Manual de instrucciones Interruptores de seguridad NZ.H/P Mode d'emploi Interrupteur de sécurité NZ.H/P Istruzioni di impiego Finecorsa di sicurezza NZ.H/P Operating Instructions Safety Switch NZ.H/P | 074550 | 11-12/16 |      |  2.1 MB |
| Instrukcja obsługi Wyłącznik bezpieczeństwa NZ.H/P | 074550 | 11-12/16 |  |  0.5 MB |
| Инструкция по эксплуатации Предохранительный выключатель NZ.H/P | 074550 | 11-12/16 |  |  0.6 MB |
| Návod na prevádzku Bezpečnostný spínač NZ.H/P | 074550 | 11-12/16 |  |  0.5 MB |

Catalogs

▼ Sicherheitsschalter mit Metallgehäuse Safety Switches with Metal Housing Bezpečnostní spínače s kovovým pouzdem Interrupteurs de sécurité avec boîtier métallique 金属壳体 的安全开关 Interruptores de seguridad con carcasa metálica

| | Doc. no. | Version | Language | Download |
|---|----------|----------|---|---|
| Sicherheitsschalter mit Metallgehäuse | 100319 | 11-03/18 |  |  7.9 MB |
| Interrupteurs de sécurité avec boîtier métallique | 100676 | 11-03/18 |  |  7.9 MB |
| Interruptores de seguridad con carcasa metálica | 104856 | 11-03/18 |  |  14.0 MB |
| Safety Switches with Metal Housing | 100369 | 11-03/18 |  |  7.9 MB |
| Bezpečnostní spínače s kovovým pouzdem | 121650 | 11-03/18 |  |  7.9 MB |
| 金属壳体 的安全开关 | 102453 | 11-03/18 |  |  8.2 MB |

Declaration of conformity

▼ EU prohlášení o shodě

| | Doc. no. | Version | Language | Download |
|--|----------|----------|---|--|
| EU-Konformitätserklärung Declaración UE de conformidad Déclaration UE de conformité Dichiarazione di conformità EU declaration of conformity | 2077153 | 25-02/17 |      |  0.3 MB |
| EU prohlášení o shodě EU-overensstemmelseserklæring Δήλωση συμμόρφωσης της ΕΕ EU-vaatimustenmukaisuusvakuutus EU-típusbizonyítvány EU-conformiteitsverklaring Deklaracja zgodności UE Declaração de Conformidade UE Declarația de conformitate UE EÚ vyhlásenie o zhode | 2077153 | 25-02/17 |          |  0.5 MB |

CAD data

CAD data for this item on TraceParts