

## ITEM 091280 NZ2WO-511L060

Description	Technical data	Accessories	Downloads
-------------	----------------	-------------	-----------



### Features

- › Version B according to EN 50041(hardened)
- › Plug connector SR6
- › LED indicator

### Approach direction

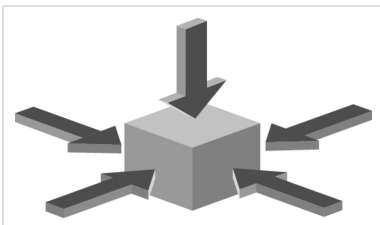

- › Figure  
Horizontal and vertical

### LED function display

A function display is available for the following voltage range:

- › AC/DC 12-60 V red

## Switching element

511 Snap-action switching contact 1 NC $\ominus$  + 1 NO

## Approvals



## Mechanical values and environment

Housing material	Anodized die-cast alloy
Weight	Net 0,3 kg
Ambient temperature	-25 ... 80 °C
Degree of protection	IP67
Mechanical life	30 x 10 <sup>6</sup>
Contact material	Silver alloy, gold flashed
Switching principle	Snap-action switching contact <sup>[1]</sup>
Installation position	Any
Number of door position positively driven contacts	1
Number of NO contacts	1
Connection	1 x Plug connector SR6 <sup>[2]</sup>
Approach speed	max. 0,1 ... 10 m/min
Actuating element	Domed plunger
Actuating force	15 ... 30 N

## Electrical connection ratings

Rated thermal current I <sub>tH</sub>	6 A
Utilization category according to EN 60947-5-1	AC-15 6A 230V DC-13 6A 24V
Short circuit protection according to IEC 60269-1	(Fuse) 6A gG
Rated insulation voltage U <sub>i</sub>	250 V
Rated impulse withstand voltage U <sub>imp</sub>	2,5 kV
Switching current	Min. at DC 24V 10 mA
Display module	AC/DC 12 ... 60 V 60 V LED red

## Reliability values acc. to EN ISO 13849-1

	<b>Monitoring of the safety guard position</b>
B10 <sub>D</sub>	20 x 10 <sup>6</sup>

[1] Contact closing time <4 contact bounce time <3

[2] 6-pin + PE

### Dimension drawing

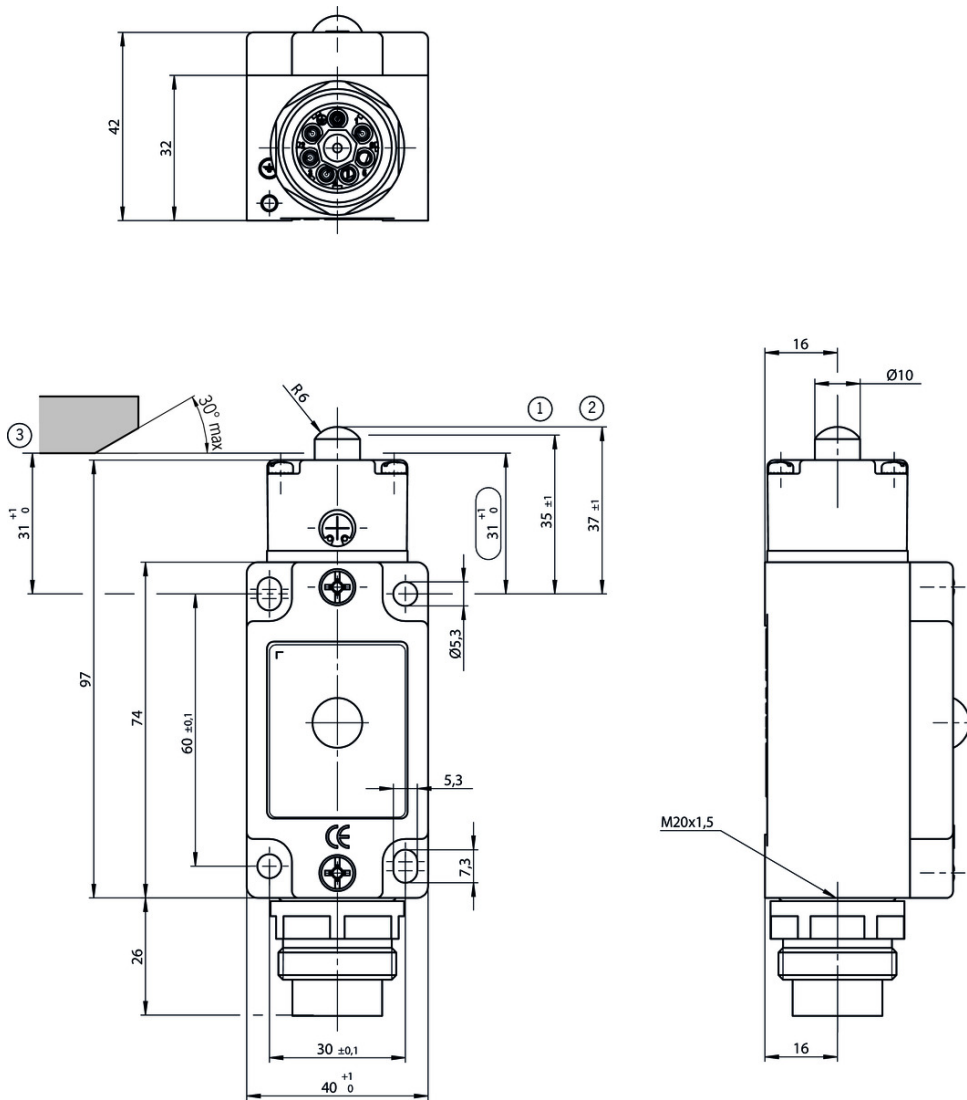

### Legende

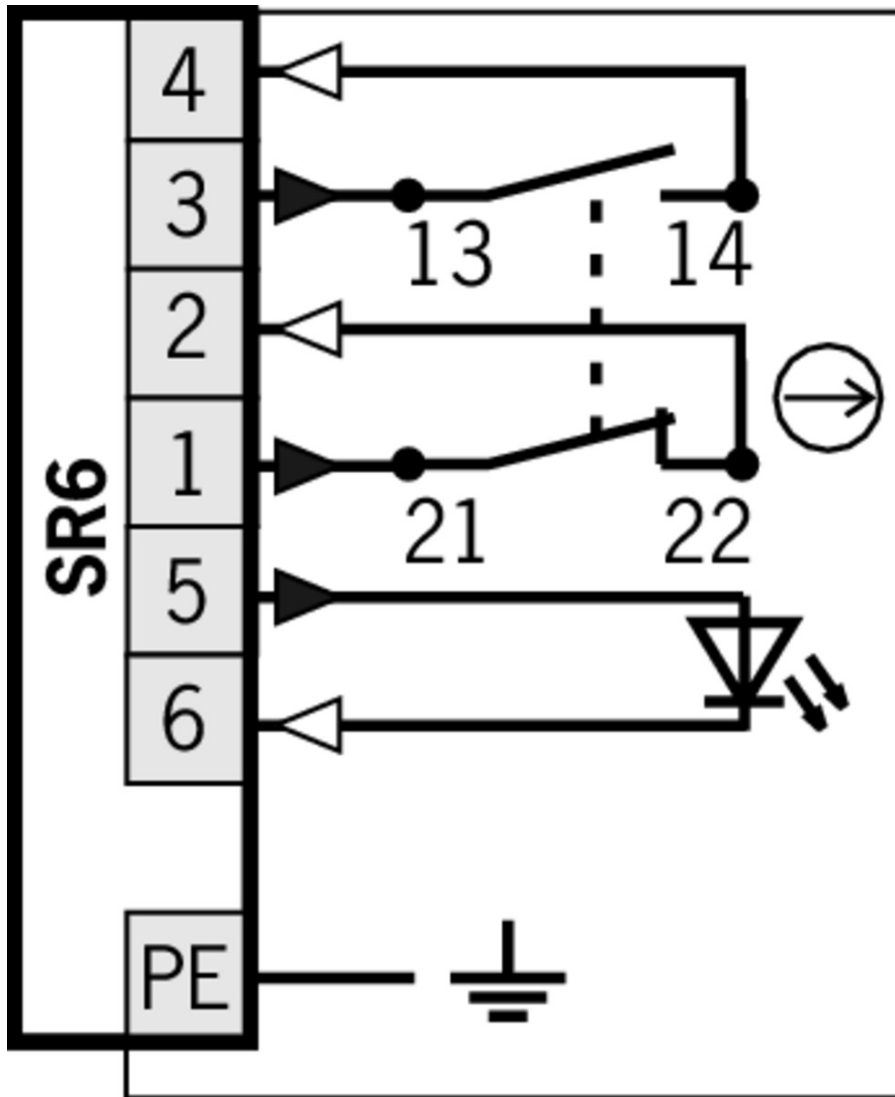

- 1 NO contact
- 2 NC contacts
- 3 Free position

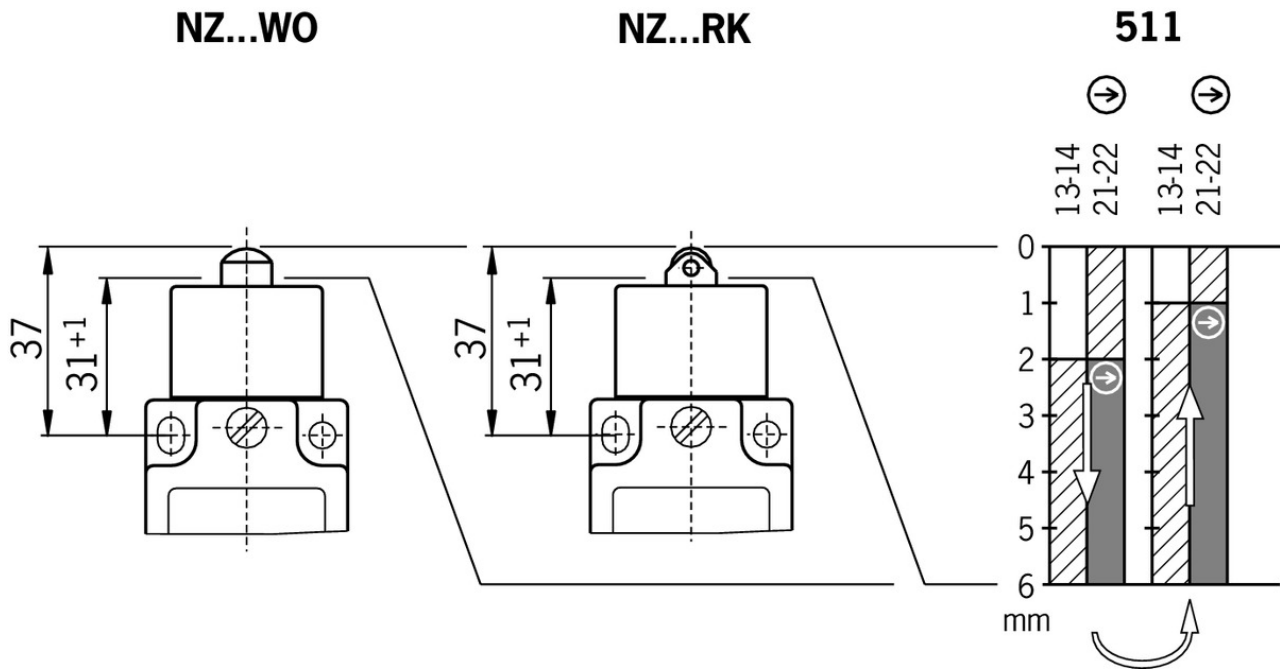

## Travel diagram



## Legende

-  Contacts closed
-  Contacts open
-  Contacts positively driven

## Connection material

### Plug connector SR6

#### **013178** SR6K

##### Features

- › Coding for plug connector SR6
- › Coding shells

#### **087180** SR6AM2-M20

##### Features

- › Crimp contacts
- › Male socket



#### **013176** SR6EF

##### Features

- › Crimp contacts
- › Coding shells

#### **024999** SR6WFPG11R



- ✔ Features
    - › Socket crimp contacts
    - › 6-pin+PE
    - › Contact carrier can be adjusted in 7 outlet directions
- 

- ✔ Connection cable with plug connector SR6, 5m



**077632** C-M26F07-07X1,0PU05,0-MA-077632

- ✔ Features
    - › Female plug SR6, 6-pin + PE
    - › Straight plug connector
    - › PUR cable
    - › Cable length 5 m
    - › With flying lead
- 

- ✔ Connection cable with plug connector SR6, 5m, angled



**077638** C-R22F07-07X1,0PU05,0-MA-077638

- ✔ Features
    - › Female plug SR6, 6-pin + PE
    - › Angled plug connector
    - › PUR cable
    - › Cable length 5 m
    - › With flying lead
- 

- ✔ Connection cable with plug connector SR6, 10m



**077633** C-M26F07-07X1,0PU10,0-MA-077633

- ✔ Features
    - › Female plug SR6, 6-pin + PE
    - › Straight plug connector
    - › PUR cable
    - › Cable length 10 m
    - › With flying lead
- 

- ✔ Connection cable with plug connector SR6, 10m, angled



**077639** C-R22F07-07X1,0PU10,0-MA-077639

- ✔ Features
    - › Female plug SR6, 6-pin + PE
    - › Angled plug connector
    - › PUR cable
    - › Cable length 10 m
    - › With flying lead
- 

- ✔ Connection cable with plug connector SR6, 15m



**077634** C-M26F07-07X1,0PU15,0-MA-077634

- ✔ Features
  - › Female plug SR6, 6-pin + PE
  - › Straight plug connector
  - › PUR cable

- › Cable length 15 m
- › With flying lead

▼ Connection cable with plug connector SR6, 15m, angled



**077640** C-R22F07-07X1,0PU15,0-MA-077640

▼ Features

- › Female plug SR6, 6-pin + PE
- › Angled plug connector
- › PUR cable
- › Cable length 15 m
- › With flying lead

▼ Connection cable with plug connector SR6, 20m



**098128** C-M26F07-07X1,0PU20,0-MA-098128

▼ Features

- › Female plug SR6, 6-pin + PE
- › Straight plug connector
- › PUR cable
- › Cable length 20 m
- › With flying lead

## Function expansion





▼ LED function display NZ



**029220** NGLE060RT

## Instructions













▼ Betriebsanleitung Sicherheitsschalter NZ.D.../NZ.W.../NZ.R...

	Doc. no.	Version	Language	Download
Betriebsanleitung Sicherheitsschalter NZ.D.../NZ.W.../NZ.R...	074549	10-01/17	 	 1.8 MB
Manual de instrucciones Interruptores de seguridad NZ.D.../NZ.W.../NZ.R...			 	
Mode d'emploi Interrupteur de sécurité NZ.D.../NZ.W.../NZ.R...				
Istruzioni di impiego Finecorsa di sicurezza NZ.D.../NZ.W.../NZ.R...				
Operating Instructions Safety Switch NZ.D.../NZ.W.../NZ.R...				
Instrukcja obsługi Wyłącznik bezpieczeństwa NZ.D.../NZ.W.../NZ.R...	074549	10-01/17		 0.4 MB

Инструкция по эксплуатации Предохранительный выключатель NZ.D.../NZ.W.../NZ.R...	074549	10-01/17		 0.6 MB
Návod na prevádzku Bezpečnostný spínač NZ.D.../NZ.W.../NZ.R...	074549	10-01/17		 0.4 MB

## Catalogs

-  Sicherheitsschalter mit Metallgehäuse Safety Switches with Metal Housing Bezpečnostní spínače s kovovým pouzdrém Interrupteurs de sécurité avec boîtier métallique 金属壳体的安全开关 Interruptores de seguridad con carcasa metálica

	Doc. no.	Version	Language	Download
Sicherheitsschalter mit Metallgehäuse	100319	11-03/18		 7.9 MB
Interrupteurs de sécurité avec boîtier métallique	100676	11-03/18		 7.9 MB
Interruptores de seguridad con carcasa metálica	104856	11-03/18		 14.0 MB
Safety Switches with Metal Housing	100369	11-03/18		 7.9 MB
Bezpečnostní spínače s kovovým pouzdrém	121650	11-03/18		 7.9 MB
金属壳体的安全开关	102453	11-03/18		 8.2 MB

## Declaration of conformity

-  EU prohlášení o shodě

	Doc. no.	Version	Language	Download
EU-Konformitätserklärung Declaración UE de conformidad Déclaration UE de conformité Dichiarazione di conformità EU declaration of conformity	2077153	25-02/17	    	 0.3 MB
EU prohlášení o shodě EU-overensstemmelseserklæring Δήλωση συμμόρφωσης της ΕΕ EU-vaatimustenmukaisuusvakuutus EU-típusbizonyítvány EU-conformiteitsverklaring Deklaracja zgodności UE Declaração de Conformidade UE Declarația de conformitate UE EÚ vyhlásenie o zhode	2077153	25-02/17	         	 0.5 MB

## CAD data

CAD data for this item on TraceParts